

## COMPREHENSIVE SERVICES

We offer competitive repair and calibration services, as well as easily accessible documentation and free downloadable resources.

## SELL YOUR SURPLUS

We buy new, used, decommissioned, and surplus parts from every NI series. We work out the best solution to suit your individual needs.

 Sell For Cash    Get Credit    Receive a Trade-In Deal

## OBSOLETE NI HARDWARE IN STOCK & READY TO SHIP

We stock **New**, **New Surplus**, **Refurbished**, and **Reconditioned** NI Hardware.



*Bridging the gap between the manufacturer and your legacy test system.*

 1-800-915-6216

 [www.apexwaves.com](http://www.apexwaves.com)

 [sales@apexwaves.com](mailto:sales@apexwaves.com)

*All trademarks, brands, and brand names are the property of their respective owners.*

**Request a Quote**

 **CLICK HERE**

**PXI-2533**

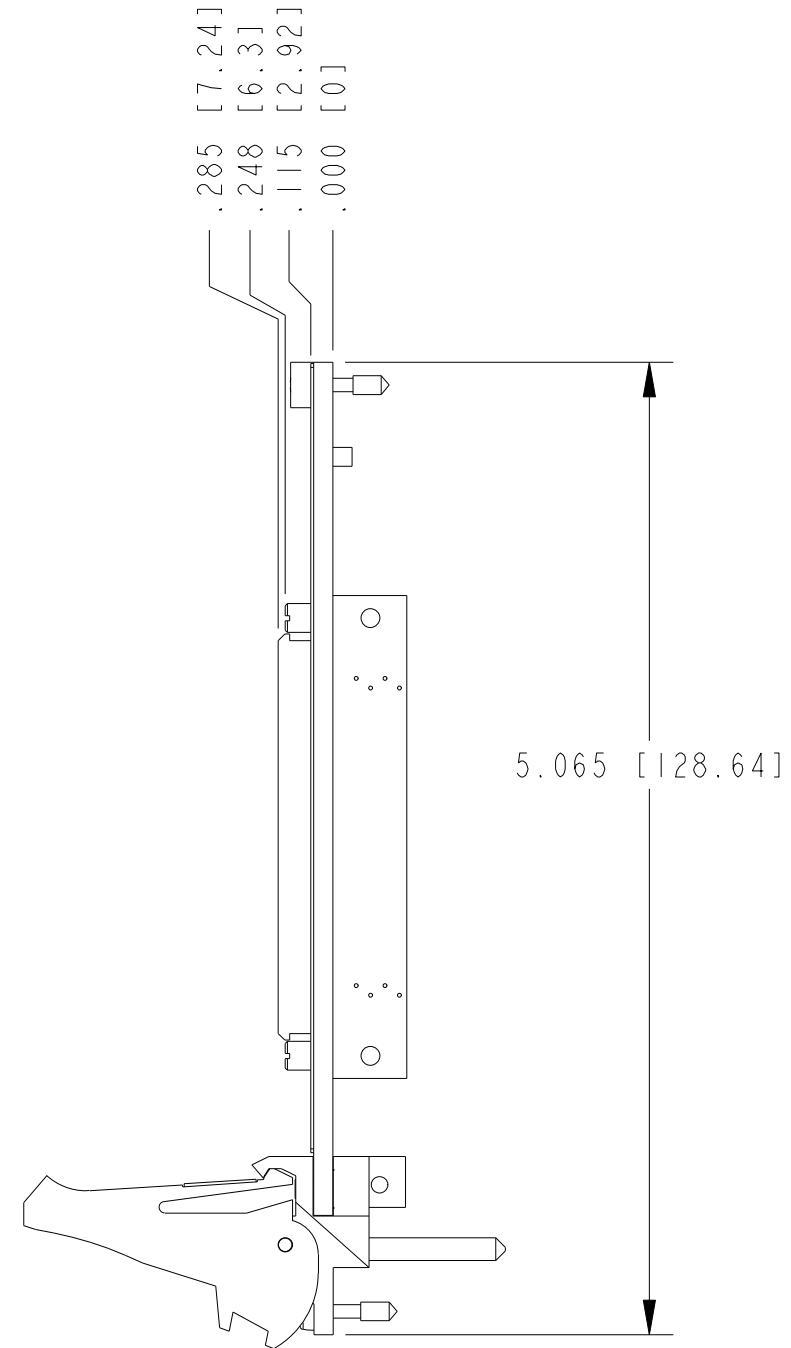
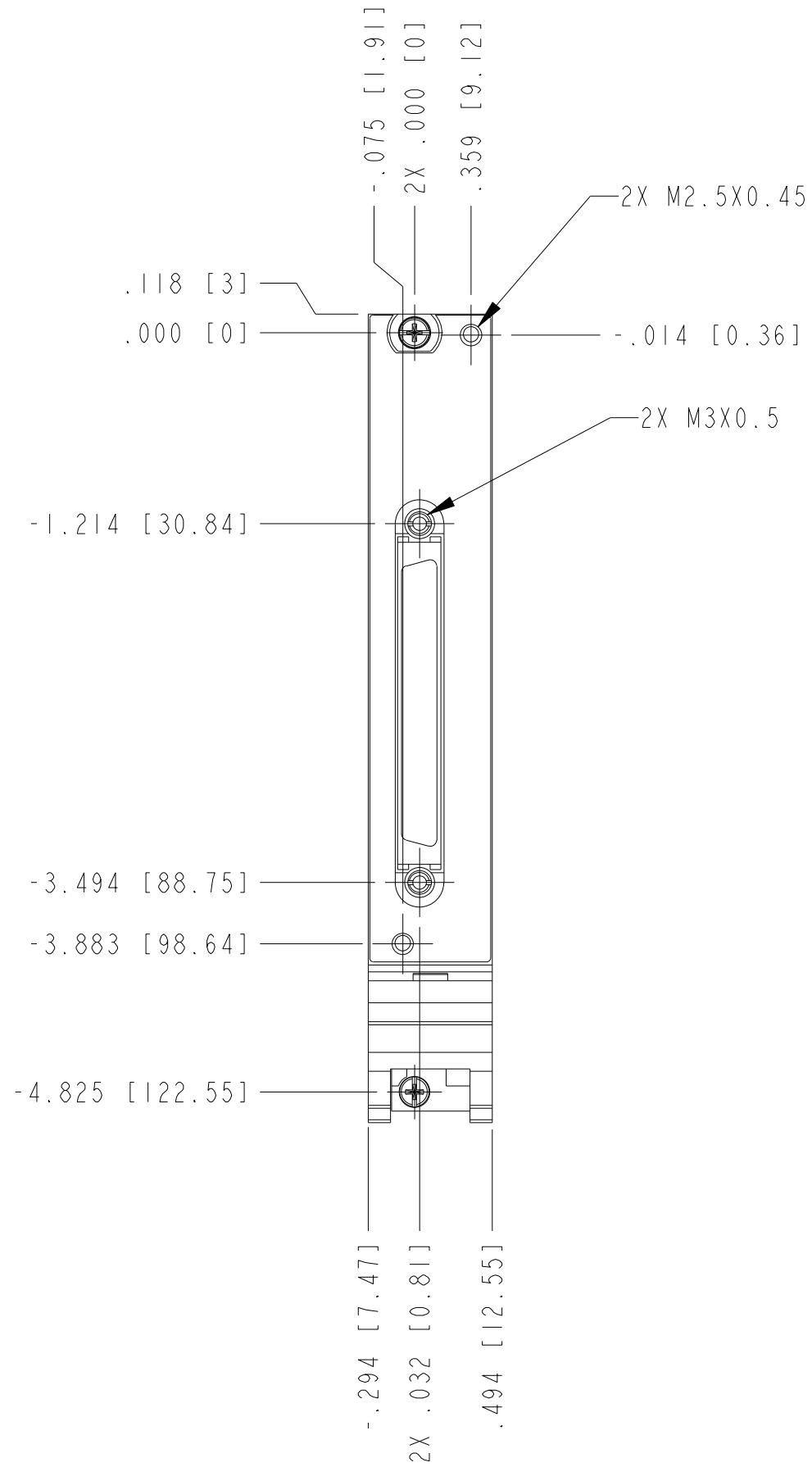

CUSTOMER DRAWING

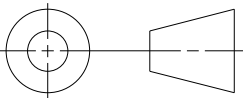
UNLESS OTHERWISE SPECIFIED DIMENSIONS ARE IN INCHES AND [MILLIMETERS].		 NATIONAL INSTRUMENTS® AUSTIN, TEXAS	
DO NOT SCALE DRAWING		TITLE PXI-2533	
THIRD ANGLE PROJECTION		SIZE CODE IDENT NO. MM/DD/YYYY B 7U296 9/8/09	
		SCALE: 1/1	SHEET   OF