

COMPREHENSIVE SERVICES

We offer competitive repair and calibration services, as well as easily accessible documentation and free downloadable resources.

SELL YOUR SURPLUS

We buy new, used, decommissioned, and surplus parts from every NI series. We work out the best solution to suit your individual needs.

 Sell For Cash  Get Credit  Receive a Trade-In Deal

OBSOLETE NI HARDWARE IN STOCK & READY TO SHIP

We stock **New**, **New Surplus**, **Refurbished**, and **Reconditioned** NI Hardware.



Bridging the gap between the manufacturer and your legacy test system.

 1-800-915-6216

 www.apexwaves.com

 sales@apexwaves.com

All trademarks, brands, and brand names are the property of their respective owners.

Request a Quote

 **CLICK HERE**

SCXI-1357

GETTING STARTED GUIDE

NI Switches

SCXI™ Switch Modules

This document explains how to install, configure, and set up a National Instruments SCXI switch module. Your NI SCXI switch module ships with the NI-SWITCH instrument driver, which you can use to program the device.

This document contains information about the NI-DAQmx driver software, which you can also use to program NI switch modules. Launch NI-DAQmx from the Start menu, or for Windows 8, from NI Launcher.



Note The protection provided by your NI switch product can be impaired if used in a manner not described in this document.

Related Information

Refer to the [NI Switches Help](#) for detailed information about features and programming options for your NI switch product.

Contents

Electromagnetic Compatibility Guidelines.....	2
Verifying the System Requirements.....	2
Verifying the Kit Contents.....	2
NI SCXI Required Items.....	2
Unpacking.....	3
Installing the Software.....	3
Installing the Hardware.....	4
Installation Procedure 1.....	6
Installation Procedure 2.....	7
Installation Procedure 3.....	12
Installation Procedure 4.....	13
Installation Procedure 5.....	14
Configuring the Hardware in MAX.....	15
Connecting Signals to Switch Terminal Blocks.....	16
Programming the NI Switch Product.....	17
NI-SWITCH Examples.....	17
Where to Go Next.....	19
Appendix A: PXI Express Compatibility.....	19
Worldwide Support and Services.....	20

Electromagnetic Compatibility Guidelines

This product was tested and complies with the regulatory requirements and limits for electromagnetic compatibility (EMC) stated in the product specifications. These requirements and limits are designed to provide reasonable protection against harmful interference when the product is operated in the intended operational electromagnetic environment.

This product is intended for use in industrial locations. However, harmful interference may occur in some installations, when the product is connected to a peripheral device or test object, or if the product is used in residential or commercial areas. To minimize interference with radio and television reception and prevent unacceptable performance degradation, install and use this product in strict accordance with the instructions in the product documentation.

Furthermore, any modifications to the product not expressly approved by National Instruments could void your authority to operate it under your local regulatory rules.



Caution To ensure the specified EMC performance, operate this product only with shielded cables and accessories.



Caution To ensure the specified EMC performance, the length of all I/O cables must be no longer than 3 m (10 ft).

Verifying the System Requirements

To use the NI-SWITCH instrument driver, your system must meet certain requirements.

For more information about minimum system requirements, recommended system, and supported application development environments (ADEs), refer to the product readme, which is available on the driver software DVD or online at ni.com/updates.

Verifying the Kit Contents

- SCXI switch module
- NI -SWITCH driver software DVD
- *NI Switches Getting Started Guide* for your NI SCXI switch module (this document)
- Specifications document for you NI SCXI switch module
- *Read Me First: Safety and Electromagnetic Compatibility*

NI SCXI Required Items

In addition to the items contained in the kit, you need the following items to install or operate your device.

- NI SCXI chassis or NI PXI/SCXI combination chassis
- Switch controller

If cabling directly to a switch controller, you also need the following items:

- Cable adapter
- Cable

Related Information

[Installing the Hardware](#) on page 4

Unpacking

Your NI switch product ships in an antistatic package to prevent electrostatic discharge from damaging device components. To prevent such damage when handling the device, ground yourself using a grounding strap or by holding a grounded object, such as your computer chassis, and complete the following steps:

1. Touch the antistatic package to a metal part of the computer chassis before removing the device from the package.



Caution Never touch the exposed pins of connectors.

2. Remove the device from the package and inspect the device for loose components or any other sign of damage.

Notify NI if the device appears damaged in any way. Do not install a damaged device into the chassis.

Installing the Software

You must install the NI-SWITCH driver software before installing the NI switch product.

NI switch modules are packaged with NI-SWITCH and NI-DAQmx. Each driver has its own API with a library of VIs and functions you can call from your ADE to program your NI switch product.

1. Optional: If you are developing an NI-SWITCH application, install an ADE, such as LabVIEW or LabWindows™/CVI™.
2. Install the latest service packs for your operating system.
3. Insert the NI-SWITCH DVD into the DVD drive.

The NI-SWITCH installer should open automatically. If the installation window does not appear, navigate to the DVD drive, double-click the drive, and double-click `autorun.exe`.

4. Follow the instructions in the installation prompts to install the NI-SWITCH driver software.
5. When the installer completes, select **Restart** in the dialog box that asks if you want to restart, shut down, or restart later and remove the driver software DVD.

Installing the Hardware

You must install the software before installing the hardware.

Before you install the hardware, refer to the guidelines in the *Maintain Forced-Air Cooling Note to Users* included with the module to ensure that the device can cool itself effectively.

This document is also available at ni.com/manuals.



Caution NI SCXI switch modules are sensitive instruments that should be handled carefully. To prevent damage to the device caused by ESD or contamination, handle the device using the edges or the metal bracket.



Caution Clean the hardware with a soft, nonmetallic brush. Make sure that the hardware is completely dry and free from contaminants before returning it to service.

To select and install a switch controller, complete the following steps:

1. Verify that your switch controller supports the switch module you want to install. Refer to the following table.

Table 1. NI Switch Controllers and Supported NI SCXI Switches

SCXI Rear Connector (10- or 50-pin)	NI Switch Module	NI Switch Controllers		
		NI 4021 or NI PXI/PCI-4065 or NI 407x	NI USB	NI E Series or M Series
	NI SCXI-1127	when used with NI SCXI-1357 kit, NI SCXI-1358 kit, or NI SCXI-1359 kit	when used with USB-1357 kit, USB-1358 kit, USB-1359 kit, or NI SCXI-1600	Indirect control ¹ when used with NI SCXI-1349 and either SH-68-68-EPM (NI E Series or mass-terminated NI USB M Series) or SHC68-68-EPM (NI PXI/PCI M Series)
	NI SCXI-1128			
	NI SCXI-1129			
	NI SCXI-1130			
	All other Modules			

¹ An NI E or M Series device can control these switches when cabled to any 50-pin rear connector NI SCXI switch module in the same chassis. Alternately, you can install an NI E or M Series device that is not PXI Express compatible in the rightmost PXI slot of an NI PXI-1010/1011/1050/1052 chassis. Refer to *Appendix A: PXI Express Compatibility* for more information about PXI Express compatible devices.

Table 1. NI Switch Controllers and Supported NI SCXI Switches (Continued)

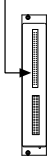
SCXI Rear Connector (10- or 50-pin)	NI Switch Module	NI Switch Controllers		
		NI 4021 or NI PXI/PCI-4065 or NI 407x	NI USB	NI E Series or M Series
	SCXI-1160/1161 ²	when used with SCXI-1362 kit	Indirect control ³ or when used with NI SCXI-1600	when used with NI SCXI-1349 and either SH68-68-EPM (NI E Series or mass-terminated NI USB M Series) or SHC68-68-EPM (NI M Series)
	SCXI-1163R			
	SCXI-1190			



Note Some switch controllers, like the NI USB-1357/1358/1359, can connect an NI SCXI switch module directly to a computer. Alternatively, a switch controller installed in the rightmost PXI slot of an NI PXI-1010/1011/1050/1052 chassis does not require any additional cables or adapters to connect to the switch module.



Note The NI 4060 device can only control the NI SCXI-1127/1128/1129/1160/1161/1163R/1190 switch modules configured using Traditional NI-DAQ (Legacy).

- Identify the adapter kit(s) required to cable the switch controller or the computer to the NI SCXI switch module.
- Determine the appropriate installation procedure for installing your NI switch module. Refer to the following table.

Table 2. Determining the NI SCXI Switch Installation Procedure

Chassis Type	NI Switch Controller Type	Installation Procedure
NI SCXI-1000 or NI SCXI-1001	PCI or PXI or mass-terminated NI USB M Series	2
	NI USB-135x	4
	NI SCXI-1600	5

² To use this module with the listed controllers, set jumpers W2, W3, and W4 on the NI switch module to MIO. Refer to the *NI SCXI-1160/1161 Jumpers Note to Users* or the *NI Switches Help* for more information.

³ An NI USB device can control these switches when cabled to a 10-pin rear connector NI SCXI switch module in the same chassis. NI USB switch controllers cannot be used with an NI PXI-1011 or an NI PXI-1052 chassis.

Table 2. Determining the NI SCXI Switch Installation Procedure (Continued)

Chassis Type	NI Switch Controller Type	Installation Procedure
NI PXI-1010 or NI PXI-1050	PXI ⁴ in rightmost PXI slot	3
	PXI not in rightmost PXI slot	2
	PXI Express compatible ⁵ in any slot	2
	NI USB-135x	4
	NI SCXI-1600	5
NI PXI-1011 or NI PXI-1052	PXI ⁶ in rightmost PXI slot	3
	NI SCXI-1600	5



Note The NI 4060 device can only control the NI SCXI-1127/1128/1129/1160/1161/1163R/1190 switch modules configured using Traditional NI-DAQ (Legacy).

Related Information

[Refer to the NI Switches Help for more information about NI switch controllers and adapter kits.](#)

Installation Procedure 1

Install an NI SCXI switch module in an existing system.

Refer to the following figure and complete the following steps to install an NI SCXI switch module in an existing system.

⁴ *PXI* refers to a PXI switch controller that is not PXI Express compatible.

⁵ PXI Express is a compatible switch controller.

⁶ *PXI* refers to a PXI switch controller that is not PXI Express compatible.

Figure 1. Installing an NI SCXI Switch Module in an Existing System

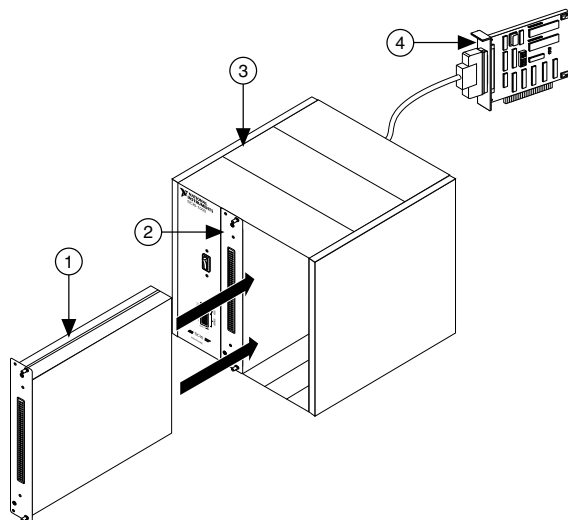

- | | |
|------------------------------|------------------------|
| 1. New NI SCXI Switch Module | 3. NI SCXI Chassis |
| 2. Existing NI SCXI Module | 4. Existing Controller |

1. Power off and unplug the chassis.
2. Remove the filler panel from an unused SCXI slot.
3. Touch any metal part of the chassis to discharge static electricity.
4. Insert the switch module into the SCXI slot.
5. Screw the switch front panel to the chassis front panel mounting rail.

Installation Procedure 2

Install an NI SCXI switch module in any of the following configurations:

- NI SCXI-1000/1001 chassis with an NI PCI or NI PXI switch controller
- NI PXI-1010/1050 chassis with a switch controller not in the rightmost PXI slot of the chassis
- NI PXI-1010/1050 chassis with an NI PXI Express compatible switch controller in any slot of the chassis

Refer to the following figure and complete the following steps to install an NI SCXI switch module.

Figure 2. Chassis Preparation

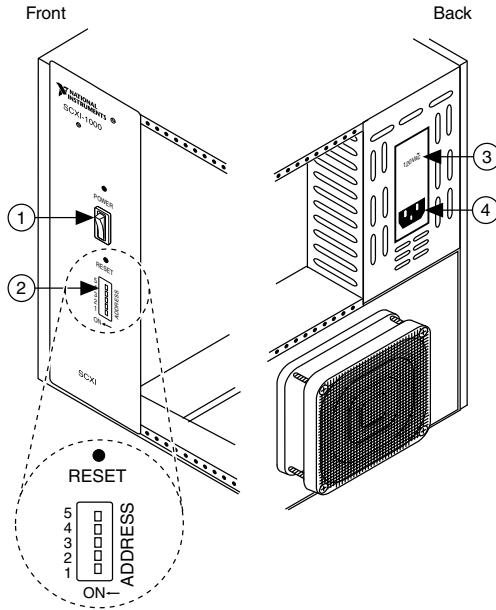

- | | |
|-----------------------------|---------------------------|
| 1. Chassis Power Switch | 3. Chassis Power Settings |
| 2. Chassis Address Switches | 4. Power Cord Connector |

1. Power off and unplug the chassis.
2. Install the switch controller, including any adapter kit(s), as described in the switch controller documentation.



Note Ensure the chassis is still powered off before continuing to install your switch module.

3. Set the chassis address switches to the OFF position. If you are using multiple SCXI chassis, ensure each chassis has a unique binary address.



Note Earlier chassis use jumpers inside the chassis front panel instead of chassis address switches. Earlier chassis also differ in fuses and AC power selection. Refer to the documentation specific to your chassis for more information.

4. Confirm the correct power settings of the chassis (100, 120, 220, or 240 VAC).
5. Remove the filler panel from an unused SCXI slot.
6. Touch any metal part of the chassis to discharge static electricity.
7. Insert the switch module into the SCXI slot.
8. Screw the switch front panel to the chassis front panel mounting rail.

After you install the module, determine the type of controller you want to use. For more information about cabling the module to a controller, refer to *NI E Series or M Series, 10-Pin Rear Connector*, or *50-Pin Rear Connector*.

Related Information

Refer to the Read Me First: NI-DAQmx and DAQ Device Installation Guide if you are installing an NI M Series device.

Refer to the NI Digital Multimeters Getting Started Guide if you are installing an NI 407x.

NI E Series or M Series

Refer to the following figure and complete the following steps to cable the switch controller to the switch module. Notice that an NI E Series or M Series device can directly cable only to an NI SCXI switch module with a 50-pin rear connector.

Figure 3. Cabling an NI E Series or M Series Device to an NI SCXI Switch Module

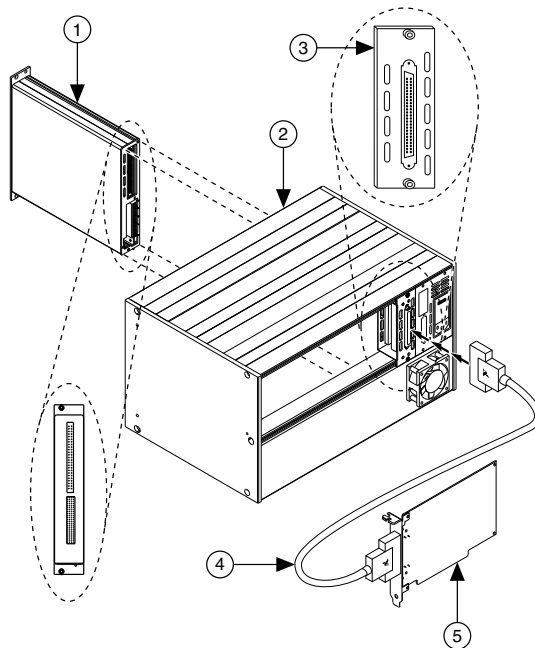

- | | |
|---|-----------------------------------|
| 1. NI SCXI Switch Module with a 50-Pin Rear Connector | 4. NI SH6868 Cable |
| 2. NI SCXI-1000/1001 or NI PXI-1010/1050 Chassis | 5. NI E Series or M Series Device |
| 3. NI SCXI-1349 Cable Adapter | |

1. Attach the NI SCXI-1349 cable adapter to the rear of the NI SCXI switch module.
2. Screw the cable adapter to the chassis mounting rail.
3. Connect one end of the NI SH6868 cable to the NI SCXI-1349 cable adapter and the other end to the NI M Series device.

4. Power on the chassis.

10-Pin Rear Connector

You must determine the number of pins on the rear connector of your NI SCXI switch module to choose the appropriate set of steps to cable the switch controller to the switch module.

Refer to the following figure and complete the following steps to cable the switch controller to an NI SCXI switch module with a 10-pin rear connector for the NI 4021/407x or NI PXI/PCI-4065.

Figure 4. Cabling an NI 4021/407x or an NI PXI/PCI-4065 to a 10-Pin Rear Connector Switch Module

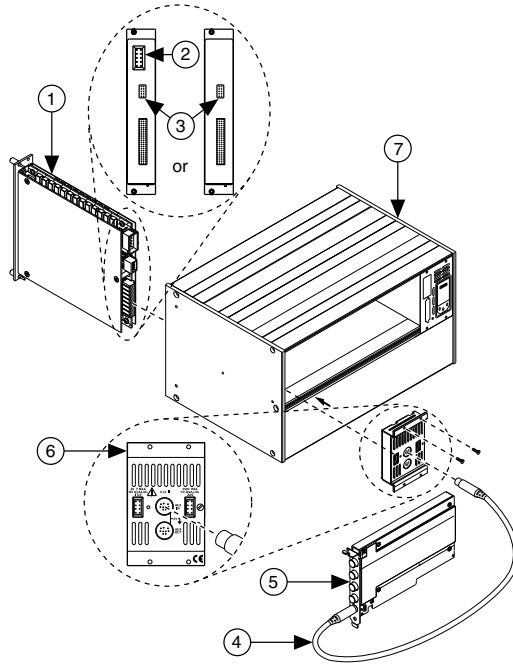

1. NI SCXI Switch Module with a 10-Pin Rear Connector
2. HVAB Connector
3. 10-Pin Rear Connector
4. SH9MD-AUX Cable
5. NI Switch Controller
6. NI SCXI-1359 Cable Adapter
7. NI SCXI-1000/1001 or NI PXI-1010/1050 Chassis

1. Attach the NI SCXI-1359, included with your kit, to the rear of the NI SCXI switch module. Ensure that the 10-pin rear connector of the switch module connects to the lower-right, 10-pin rear connector on the NI SCXI-1359.
2. Screw the backplane adapter to the chassis mounting rail.
3. Connect one end of the SH9MD-AUX cable to the AUX IN of the NI SCXI-1359 and the other end to the NI 407x.

4. Power on the chassis.

Related Information

Refer to the NI Switches Help for more information about the connectors on the NI SCXI-1359.

50-Pin Rear Connector

You must determine the number of pins on the rear connector of your NI SCXI switch module to choose the appropriate set of steps to cable the switch controller to the switch module.

Refer to the following figure and complete the following steps to cable the switch controller to your NI SCXI switch module with a 50-pin rear connector for the NI 4021/407x or NI PXI/PCI-4065.

Figure 5. Cabling an NI 4021/407X or an NI PXI/PCI-4065 to a 50-Pin Rear Connector Switch Module

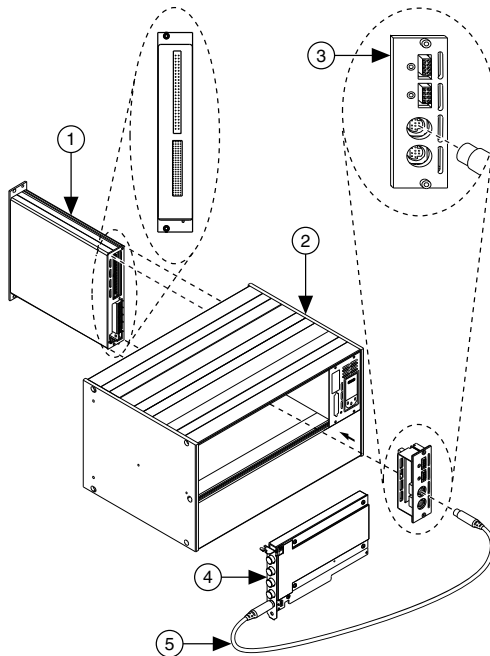

- | | |
|---|-------------------------|
| 1. NI SCXI Switch Module with a 50-Pin Rear Connector | 4. NI Switch Controller |
| 2. NI SCXI-1000/1001 or NI PXI-1010/1050 Chassis | 5. SH9MD-AUX Cable |
| 3. NI SCXI-1362 Cable Adapter | |

1. Attach the NI SCXI-1362 cable adapter to the rear of your NI SCXI switch module.
2. Screw the cable adapter to the chassis mounting rail.
3. Connect one end of the SH9MD-AUX cable to the NI SCXI-1362 cable adapter and the other end to the NI 407x.

4. Power on the chassis.

Installation Procedure 3

Install an NI PXI-1010/1011/1050/1052 chassis with a PXI switch controller in the rightmost PXI slot of the chassis.



Note No cables are required to connect the switch module to the switch controller.

Refer to the following figure and complete the following steps to install an NI SCXI switch module.

Figure 6. NI Switch Controller in the Rightmost PXI Slot

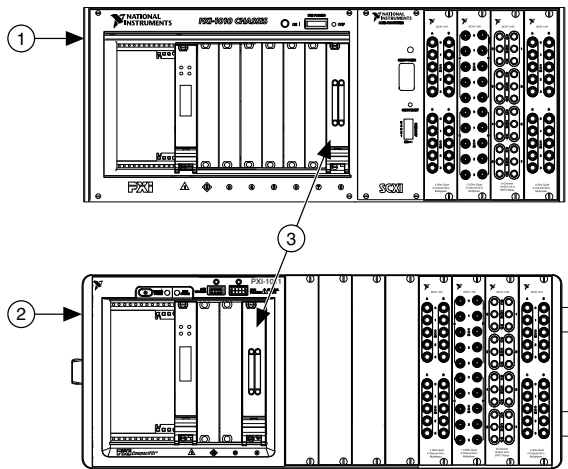

1. NI PXI-1010/1050 Chassis
2. NI PXI-1011/1052 Chassis
3. Controller

1. Power off and unplug the chassis.
2. Install the switch controller, including any adapter kit(s), as described in the switch controller documentation.
3. (NI PXI-1010 only) Set the chassis address switches to the OFF position as shown in the following figure.
4. Confirm the correct power settings of the chassis (100 VAC, 120 VAC, 220 VAC, or 240 VAC).



Note Refer to the documentation specific to your chassis for the correct voltage for your region.

5. Remove the filler panel from an unused SCXI slot.
6. Touch any metal part of the chassis to discharge static electricity.
7. Insert the switch module into the SCXI slot.

- Screw the switch front panel to the chassis front panel mounting rail.
- Power on the chassis.

Related Information

Refer to the Read Me First: NI-DAQmx and DAQ Device Installation Guide if you are installing an NI PXI/PCI M Series device.

Refer to the NI Digital Multimeters Getting Started Guide if you are installing an NI 407x.

Installation Procedure 4

Connect an NI USB switch controller/adapter directly to an NI SCXI switch module with a 10-pin rear connector.

Refer to the following figure and complete the following steps to install an NI SCXI switch module and cable it to an NI USB switch controller

Figure 7. Cabling an NI USB Switch Controller to a 10-Pin Rear Connector Switch Module

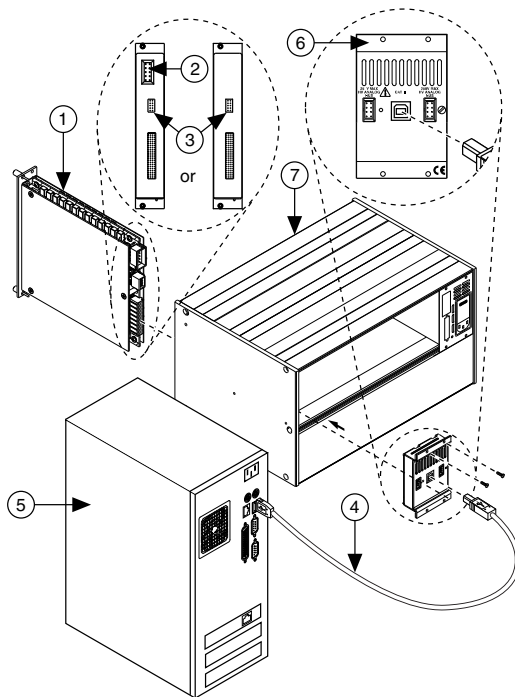

- | | |
|--------------------------|--|
| 1. NI SCXI Switch Module | 5. NI Switch Controller |
| 2. HVAB Connector | 6. NI 1359 Cable Adapter |
| 3. 10-Pin Rear Connector | 7. NI SCXI-1000/1001 or NI PXI-1010/1050 Chassis |
| 4. USB Cable | |

- Power off and unplug the chassis.

2. Set the chassis address switches to the OFF position.



Note Earlier chassis use jumpers inside the chassis front panel instead of chassis address switches. Earlier chassis also differ in fuses and AC power selection. Refer to the documentation specific to your chassis for more information.

3. Confirm the correct power settings of the chassis (100 VAC, 120 VAC, 220 VAC, or 240 VAC).



Note Refer to the documentation specific to your chassis for the correct voltage for your region.

4. Remove the filler panel in an unused SCXI slot.
5. Touch any metal part of the chassis to discharge static electricity.
6. Insert the switch module into the SCXI slot.
7. Screw the switch front panel to the chassis front panel mounting rail.
8. Attach the NI USB-1359, included with the kit, to the rear of the NI SCXI switch module. Ensure that the 10-pin rear connector of the switch module connects to the black lower-right 10-pin rear connector of the NI USB-1359.
9. Screw the backplane adapter to the chassis mounting rail.
10. Power on the chassis. You must power on the chassis before you connect the NI USB-1359 to the computer to auto-detect the NI USB-1359 and auto-create the chassis in MAX.



Note If you are using an NI PXI-1010/1050 the chassis appears in MAX as an NI SCXI-1000 chassis.

11. Connect one end of the USB cable to the NI USB-1359 and the other end to a USB hub or a USB port on a computer.

Related Information

[Refer to the NI Switches Help for more information about the connectors on the NI USB-1359.](#)
[Refer to the NI 1357/1358/1359 SCXI Controller/Adapter Kit Installation Guide for more information about USB switch control.](#)

Installation Procedure 5

Install a switch module in any SCXI chassis with an NI SCXI-1600 switch module controller installed in any slot in the chassis.

Refer to the following figure and complete the following steps to install an NI SCXI switch module.

Figure 8. Installing an NI SCXI Switch Module in an SCXI Chassis with an NI SCXI-1600 Controller

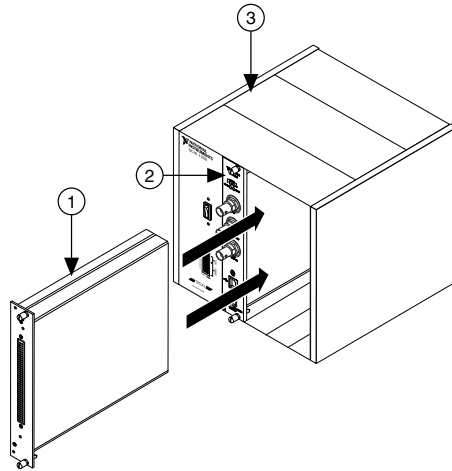

1. New NI SCXI Switch Module
2. NI SCXI-1600 Switch Module Controller
3. NI SCXI Chassis

1. Power off and unplug the chassis.
2. Install and configure the NI SCXI-1600 switch module controller.



Note Ensure the chassis is still powered off before continuing to install your switch module.

3. Remove the filler panel from an unused SCXI slot.
4. Touch any metal part of the chassis to discharge static electricity.
5. Insert the switch module into the SCXI slot.
6. Screw the switch front panel to the chassis front panel mounting rail.
7. Connect one end of the USB cable to the NI SCXI-1600 and the other end to a USB hub or a USB port on a computer.

Related Information

Refer to the [SCXI Quick Start Guide](#) for more information about installing and configuring the NI SCXI-1600.

Configuring the Hardware in MAX

Your SCXI switch and your switch controller determine your MAX configuration options. Refer to the following table to determine your MAX configuration options.

Table 3. MAX Configuration Options

NI Controller	NI SCXI-1127/1128/1129/ 1160/1161/1163R/ 1190/1191/1192 Switches	All Other NI SCXI Switches
NI 407x, NI 4065, M Series, NI 4021	NI-DAQmx/Traditional NI-DAQ (Legacy)	NI-DAQmx
NI 4060	Traditional NI-DAQ (Legacy)	-
NI USB	NI-DAQmx	



Note The NI 4060 device can only control NI SCXI-1127/1128/1129/1160/1161/1163R/1190 switch modules configured using Traditional NI-DAQ (Legacy). For software support information, refer to the preceding table.

1. Launch MAX by navigating to **Start»All Programs»National Instruments»NI MAX** or by clicking the NI MAX desktop icon.
2. Right-click **Devices and Interfaces**. Select **Create New**.
3. In the **Create New** window, go to **NI-DAQmx SCXI Chassis**. Select the SCXI chassis you want to add. Configure the following settings:
 - Select the switch controller (**NI USB-1359** or **NI 407x**) cabled to the communicating SCXI switch module from the **Chassis Communicator** drop-down listbox. If MAX detects only one communicating device, this device is selected as the chassis communicator by default and the listbox is dimmed.
 - (**NI SCXI kits only**) Select the module slot connected to the chassis communicator from the **Communicating SCXI Module Slot** drop-down list.
 - In the **Chassis Address** text box, enter the appropriate chassis address setting. The correct chassis address jumper settings are shown in the interactive DIP switch graphic in the configuration window. Make sure the software setting matches the actual chassis address setting on the SCXI chassis.
 - If you want NI-DAQ to automatically detect the SCXI modules in the chassis, check **Auto-Detect All Modules**.
4. Click **Save** when you are finished.
5. Right-click the SCXI chassis you just added. Select **Configure**.
6. In the **SCXI Chassis Configuration** window, click the **Modules** tab. Select the module you want to add from the **Modules** drop-down listbox.
7. Click **Details** to configure the module settings.

Connecting Signals to Switch Terminal Blocks

Refer to the documentation for your terminal block to install the terminal block and connect signals to the NI switch product.

Programming the NI Switch Product

You can acquire data interactively using the NI-SWITCH Soft Front Panel (SFP), or you can control the device programmatically using the NI-SWITCH instrument driver. You can then use NI-SWITCH to program the device in the application development environment (ADE) of your choice.

Table 4. NI Switch Product Programming Options

Application Programming Interface (API)	Location	Description
NI-SWITCH SFP	Available from the Start menu or NI Launcher in Windows 8.	Provides a graphical interface for controlling and viewing the state of your NI switch product.
NI-SWITCH Instrument Driver	LabVIEW or LabWindows/CVI— Available on the LabVIEW Functions palette at Measurement I/O»NI-SWITCH .	Features a set of operations and attributes that exercise all the functionality of the NI switch product, including configuration, control, and other device-specific functions.
	C or LabWindows/CVI— Available at Program Files \IVI Foundation\IVI \Drivers\niSWITCH.	
	Installed examples for Visual C/C++ are in the <i>NI-SWITCH Readme</i> .	Refer to the <i>Creating an Application with Microsoft Visual C/C++</i> topic in the <i>NI Switches Help</i> for information about developing an NI-SWITCH application.
NI-DAQmx Instrument Driver	Available from the Start menu or NI Launcher in Windows 8. To locate examples, go to ni.com/info and enter the Info Code <code>daqmxexp</code> . For additional examples, refer to zone.ni.com .	You can operate NI switch products with the NI-DAQmx API. NI-DAQmx is useful when using hardware scanning with multiple NI switch products. The NI-DAQmx API supports all NI switch products and is not IVI compliant.

NI-SWITCH Examples

Examples demonstrate the functionality of the device and serve as programming models and building blocks for your own applications. The NI Example Finder is a utility available for some software applications that organizes examples into categories and allows you to easily

browse and search installed examples. You can see descriptions and compatible hardware models for each example or see all the examples compatible with one particular hardware model.

Table 5. Locating NI-SWITCH Examples

Software Application	How to Locate Examples
LabVIEW or LabWindows/CVI	Locate examples with the NI Example Finder. Within LabVIEW or LabWindows/CVI, select Help»Find Examples and navigate to Hardware Input and Output»Modular Instruments .
ANSI C or Microsoft Visual C/C++	Locate examples in the <NIDocDir>\NI-SWITCH\examples directory, where <NIDocDir> is one of the following directories: <ul style="list-style-type: none"> • Windows XP—Documents and Settings\All Users\Documents\National Instruments • Windows 7/8/Vista—Users\Public\Documents\National Instruments

Where to Go Next

Refer to the following figure for information about other product tasks and associated resources for those tasks.

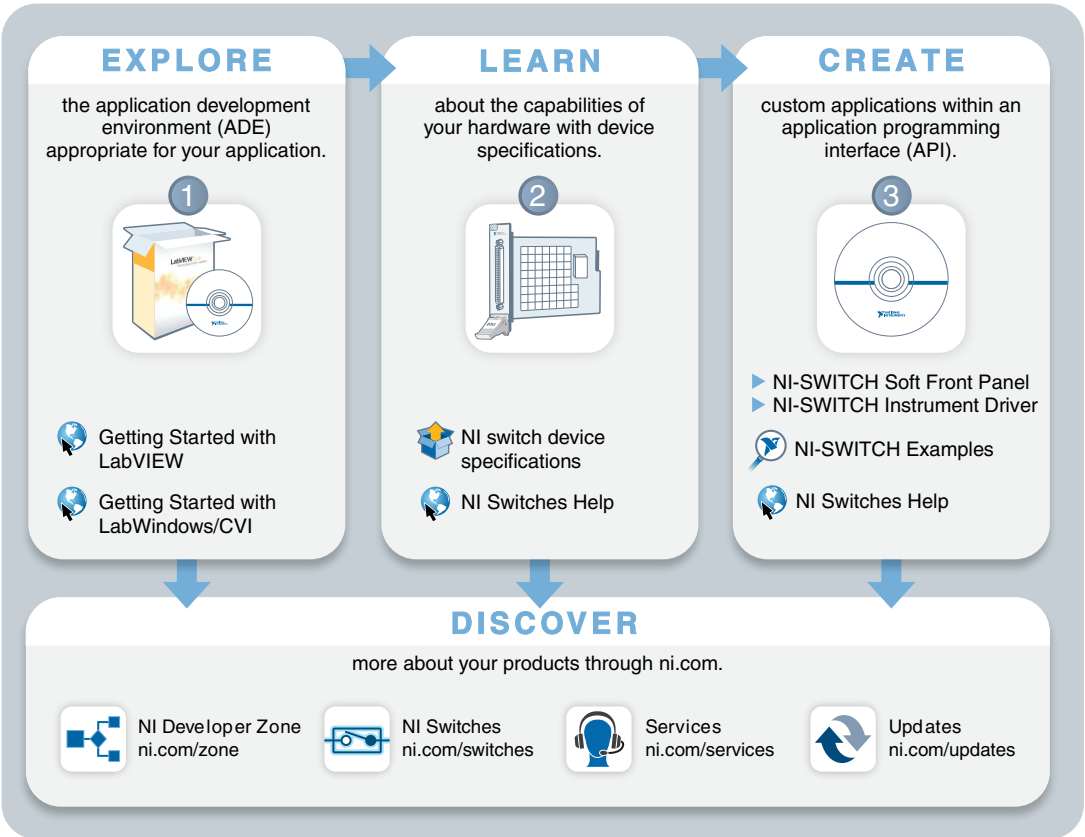

Located in the hardware kit



Located online at ni.com/manuals



Located using the NI Example Finder

Appendix A: PXI Express Compatibility

A modified PXI module is a hybrid slot compatible PXI module where the top rear connector is replaced with a small connector. Refer to the following figure to determine if your NI switch product is hybrid-slot compatible.

Figure 9. PXI Module and PXI Express Compatible Module

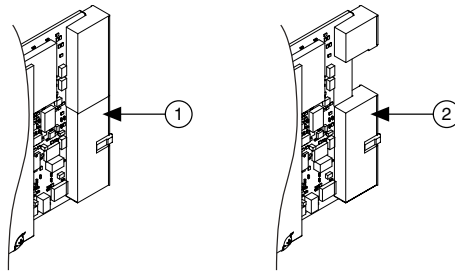

1. Standard PXI Switch Module
2. PXI Express Compatible Switch Module

A hybrid slot compatible PXI module can operate in the following slots:

- A Standard PXI slot or an NI PXI/PXI Express chassis
- A Hybrid slot compatible PXI module



Note Unlike hybrid slot compatible modules, PXI cards can only operate in standard PXI slots.

Hybrid slot compatible PXI modules preserve the following features:

Table 6. Hybrid Slot Compatibility PXI Module Features

Software compatibility	Hybrid slot compatibility requires no changes to existing applications and/or driver software.
Specifications	Hybrid slot compatibility does not alter module specifications.
PXI communication	Hybrid slot compatibility supports existing PXI timing and PXI triggering capabilities.

Refer to your NI PXI/PXI Express chassis documentation to determine which slots are PXI slots, PXI Express slots, or PXI Express Hybrid slots.

Related Information

Refer to the [PXI Systems Alliances](#) for the defined modifications to incorporate PCI Express signaling into PXI.

Worldwide Support and Services

The National Instruments website is your complete resource for technical support. At ni.com/support you have access to everything from troubleshooting and application development self-help resources to email and phone assistance from NI Application Engineers.

Visit ni.com/services for NI Factory Installation Services, repairs, extended warranty, and other services.

Visit ni.com/register to register your National Instruments product. Product registration facilitates technical support and ensures that you receive important information updates from NI.

A Declaration of Conformity (DoC) is our claim of compliance with the Council of the European Communities using the manufacturer's declaration of conformity. This system affords the user protection for electromagnetic compatibility (EMC) and product safety. You can obtain the DoC for your product by visiting ni.com/certification. If your product supports calibration, you can obtain the calibration certificate for your product at ni.com/calibration.

National Instruments corporate headquarters is located at 11500 North Mopac Expressway, Austin, Texas, 78759-3504. National Instruments also has offices located around the world. For telephone support in the United States, create your service request at ni.com/support or dial 512 795 8248. For telephone support outside the United States, visit the *Worldwide Offices* section of ni.com/niglobal to access the branch office websites, which provide up-to-date contact information, support phone numbers, email addresses, and current events.

Refer to the *NI Trademarks and Logo Guidelines* at ni.com/trademarks for information on National Instruments trademarks. Other product and company names mentioned herein are trademarks or trade names of their respective companies. For patents covering National Instruments products/technology, refer to the appropriate location: **Help»Patents** in your software, the `patents.txt` file on your media, or the *National Instruments Patent Notice* at ni.com/patents. You can find information about end-user license agreements (EULAs) and third-party legal notices in the readme file for your NI product. Refer to the *Export Compliance Information* at ni.com/legal/export-compliance for the National Instruments global trade compliance policy and how to obtain relevant HTS codes, ECCNs, and other import/export data.

© 2010—2013 National Instruments. All rights reserved.

375471B-01 Aug13