

COMPREHENSIVE SERVICES

We offer competitive repair and calibration services, as well as easily accessible documentation and free downloadable resources.

SELL YOUR SURPLUS

We buy new, used, decommissioned, and surplus parts from every NI series. We work out the best solution to suit your individual needs.

 Sell For Cash  Get Credit  Receive a Trade-In Deal

OBSOLETE NI HARDWARE IN STOCK & READY TO SHIP

We stock **New**, **New Surplus**, **Refurbished**, and **Reconditioned** NI Hardware.



Bridging the gap between the manufacturer and your legacy test system.

 1-800-915-6216

 www.apexwaves.com

 sales@apexwaves.com

All trademarks, brands, and brand names are the property of their respective owners.

Request a Quote

 **CLICK HERE**

PXIe-7820

GETTING STARTED GUIDE

NI PXIe-7820R

R Series for PXI Express Digital RIO with Kintex-7 160T FPGA

Français	Deutsch	日本語	한국어	简体中文
ni.com/manuals				

This document explains how to install and configure the NI PXIe-7820R.

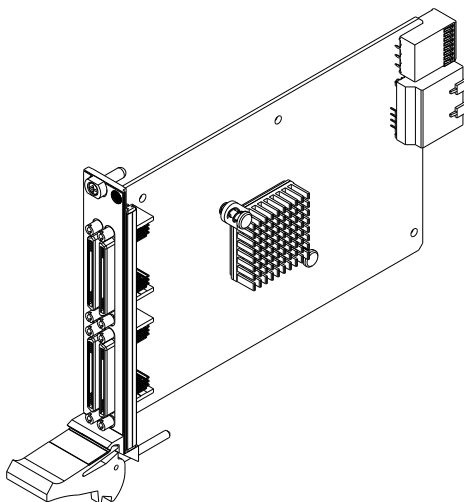

Safety Guidelines



Caution Do not operate the NI PXIe-7820R in a manner not specified in this user manual. Product misuse can result in a hazard. You can compromise the safety protection built into the product if the product is damaged in any way. If the product is damaged, return it to National Instruments for repair.

Electromagnetic Compatibility Guidelines

This product was tested and complies with the regulatory requirements and limits for electromagnetic compatibility (EMC) as stated in the product specifications. These

requirements and limits are designed to provide reasonable protection against harmful interference when the product is operated in its intended operational electromagnetic environment.

This product is intended for use in residential, commercial, and industrial locations. However, harmful interference may occur in some installations or when the product is connected to a peripheral device or a test object. To minimize interference with radio and television reception and prevent unacceptable performance degradation, install and use this product in strict accordance with the instructions in the product documentation.

Furthermore, any changes or modifications to the product not expressly approved by National Instruments could void your authority to operate it under your local regulatory rules.



Caution To ensure the specified EMC performance, operate this product only with shielded cables and accessories. Do not use unshielded cables or accessories unless they are installed in a shielded enclosure with properly designed and shielded input/output ports and connected to the product using a shielded cable. If unshielded cables or accessories are not properly installed and shielded, the EMC specifications for the product are no longer guaranteed.



Caution To ensure the specified EMC performance, install two (2) snap-on, ferrite beads (777297-01) per connected I/O cable in accordance with the product installation instructions.



Caution To ensure the specified EMC performance, the length of any cable connected to the input port(s) must be no longer than 3 m (10 ft).

Unpacking the Kit



Caution To prevent electrostatic discharge (ESD) from damaging the device, ground yourself using a grounding strap or by holding a grounded object, such as your computer chassis.

1. Touch the antistatic package to a metal part of the computer chassis.
2. Remove the device from the package and inspect the device for loose components or any other sign of damage.



Caution Never touch the exposed pins of connectors.



Note Do not install a device if it appears damaged in any way.

3. Unpack any other items and documentation from the kit.

Store the device in the antistatic package when the device is not in use.

Verifying the Kit Contents

Verify that the following components are in your kit.

Figure 1. Kit Contents for the NI PXIe-7820R

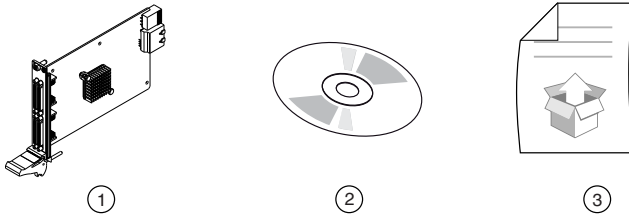

1. Hardware
2. NI-RIO Media
3. Getting Started Guide

Preparing the Environment

Ensure that the environment in which you are using the NI PXIe-7820R meets the following specifications.

Operating temperature.....0° C to 55° C
(IEC 60068-2-1, IEC 60068-2-2)

Operating humidity.....10% RH to 90% RH, noncondensing
(IEC 60068-2-56)

Pollution degree.....2

Maximum altitude.....2,000 m

Indoor use only.



Note Refer to the device datasheet on ni.com/manuals for complete specifications.

Installing Software on the Host Computer

Before using the NI PXIe-7820R, you must install the following application software and device drivers on the host computer.

1. LabVIEW 2014 SP1 or later
2. LabVIEW Real-Time Module 2014 SP1 or later¹
3. LabVIEW FPGA Module 2014 SP1 or later
4. NI-RIO Device Drivers February 2015 or later

¹ LabVIEW Real Time Module is only required if the R Series board is being used on a PXIe controller with a real-time operating system.

Installing the NI PXIe-7820R



Caution To prevent damage to the device caused by ESD or contamination, handle the device using the edges or the metal bracket.

1. Ensure the AC power source is connected to the chassis before installing the modules.

The AC power cord grounds the chassis and protects it from electrical damage while you install the modules.

2. Power off the chassis.
3. Inspect the slot pins on the chassis backplane for any bends or damage prior to installation. Do not install a module if the backplane is damaged.
4. Remove the black plastic connectors from all the captive screws on the module front panel.
5. Identify a supported slot in the chassis. The following figure shows the symbols that indicate the slot types.

Figure 2. Chassis Compatibility Symbols

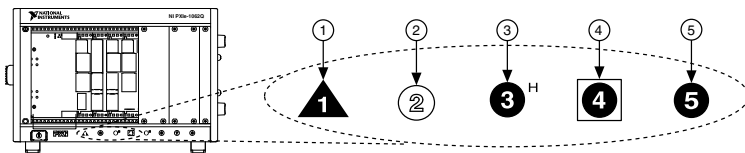

- | | |
|---------------------------------------|-----------------------------------|
| 1. PXI Express System Controller Slot | 4. PXI Express System Timing Slot |
| 2. PXI Peripheral Slot | 5. PXI Express Peripheral Slot |
| 3. PXI Express Hybrid Peripheral Slot | |

NI PXIe-7820R modules can be placed in PXI Express peripheral slots, PXI Express hybrid peripheral slots, or PXI Express system timing slots.

6. Touch any metal part of the chassis to discharge static electricity.
7. Ensure that the ejector handle is in the unlatched (downward) position.
8. Place the module edges into the module guides at the top and bottom of the chassis. Slide the device into the slot until it is fully inserted.

Figure 3. Module Installation

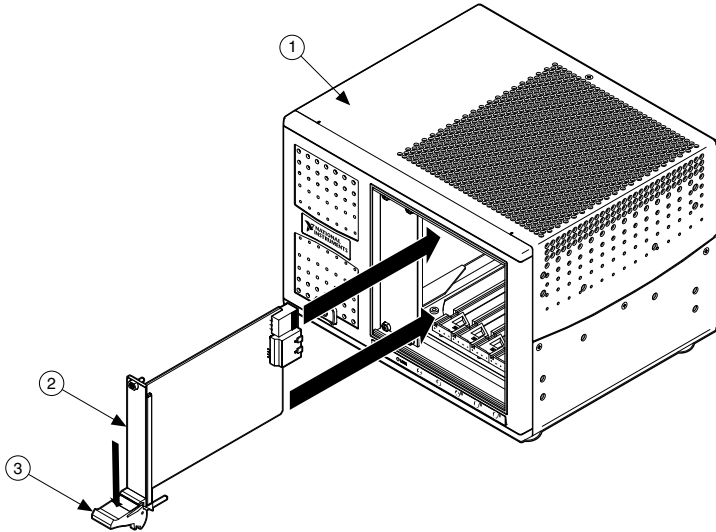

1. Chassis
2. Hardware
3. Ejector Handle in Down (Unlatched) Position

9. Latch the module in place by pulling up on the ejector handle.
10. Secure the device front panel to the chassis using the front-panel mounting screws.



Note Tightening the top and bottom mounting screws increases mechanical stability and also electrically connects the front panel to the chassis, which can improve the signal quality and electromagnetic performance.

11. Cover all empty slots using filler panels or slot blockers to maximize cooling air flow.
12. Power on the chassis.

Verifying Hardware Installation for Host Targets

You can verify that the system recognizes the NI PXIe-7820R by using Measurement & Automation Explorer (MAX).

1. Launch MAX by navigating to **Start»All Programs»National Instruments»MAX** or by clicking the MAX desktop icon.
2. Expand **Devices and Interfaces**.
3. Verify that the device appears under **Devices and Interfaces**.

If the device does not appear, press <F5> to refresh the view in MAX. If the device does not appear after refreshing the view, visit ni.com/support for troubleshooting information.

Verifying Hardware Installation for Remote Targets

You can verify that the system recognizes the NI PXIe-7820R by using Measurement & Automation Explorer (MAX).

1. Launch MAX on the host computer.
2. Expand **Remote Targets** in the configuration tree and locate your system.
3. Install LabVIEW Real-Time Module 2014 SP1 and NI RIO Device Drivers February 2015 or later on your **Remote Target**.
 - a) Refer to the *Installing Software on the Host Computer* section for information about installing software on the host.
 - b) Refer to the *PXI Express Controllers User Manual* at ni.com/manuals for information on installing software on the target.
4. Under **Remote Targets**, find and expand **Devices and Interfaces**.

If the device does not appear, press <F5> to refresh the view in MAX. If the device does not appear after refreshing the view, visit ni.com/support for troubleshooting information.

Connecting the NI PXIe-7820R

NI recommends using the following cables and accessories with the NI PXIe-7820R:

- EMI suppression ferrites (777297-01)
- Shielded 68-Pin Connector Block for R Series DIO & HSDIO Products (782914-01)
- Shielded R Series High Speed Digital Cable, 1m (156166-01)
- Shielded R Series High Speed Digital Cable, 2m (156166-02)



Note NI is not liable for connections that exceed any of the maximum ratings of input or output signals on the NI PXIe-7820R and on the computer chassis. Refer to the *NI PXIe-7820R Specifications*, available at ni.com/manuals for the maximum input and output ratings for each signal.

Table 1. NI PXIe-7820R Pinout

Pinout			Signal	Description
			DIO <0...31>	Digital I/O data through channels 0 through 31.
			GND	Ground reference for signals.
			External Clock	External clock input source that can be used for source synchronous acquisitions. The provided clock source must be stable and glitch-free.
GND	68	34	GND	
External Clock x*	67	33	GND	
GND	66	32	GND	
DIO0	65	31	DIO1	
GND	64	30	GND	
DIO2	63	29	DIO3	
GND	62	28	GND	
DIO4	61	27	DIO5	
GND	60	26	GND	
DIO6	59	25	DIO7	
GND	58	24	GND	
DIO8	57	23	DIO9	
GND	56	22	GND	
DIO10	55	21	DIO11	
GND	54	20	GND	
DIO12	53	19	DIO13	
GND	52	18	GND	
DIO14	51	17	DIO15	
GND	50	16	GND	
DIO16	49	15	DIO17	
GND	48	14	GND	
DIO18	47	13	DIO19	
GND	46	12	GND	
DIO20	45	11	DIO21	
GND	44	10	GND	
DIO22	43	9	DIO23	
GND	42	8	GND	
DIO24	41	7	DIO25	
GND	40	6	GND	
DIO26	39	5	DIO27	
GND	38	4	GND	
DIO28	37	3	DIO29	
GND	36	2	GND	
DIO30	35	1	DIO31	

* x is the connector number.
External Clock x is an input only.

The NI PXIe-7820R is protected from overvoltage and overcurrent conditions. Refer to the *NI PXIe-7820R Specifications*, available at ni.com/manuals, for more information on overvoltage and overcurrent conditions.

Digital I/O

The NI PXIe-7820R provides connections for 128 digital input/output (DIO) channels. Connectors 0 through 3 each contain 32 high-speed DIO channels that can run up to 80 MHz signal frequencies. Each connector has selectable logic levels that you can configure as 1.2 V, 1.5 V, 1.8 V, 2.5 V, or 3.3 V. You can configure each channel as input or output.

Figure 4. Connecting to the DIO Channels

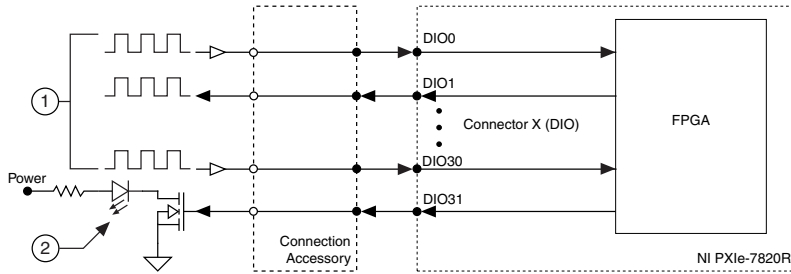

1. High-speed signal frequencies up to 80 MHz with logic levels configured as 1.2 V, 1.5 V, 1.8 V, 2.5 V, or 3.3 V
2. LED

The DIO channels connect to the FPGA through protection circuitry, which has overvoltage and undervoltage protection as well as overcurrent protection. Refer to the *NI PXIe-7820R Specifications* for more information about the maximum voltage and current.

When the system powers on, the DIO channels are set as input low with pull-down resistors. To set another power-on state, you can configure the NI PXIe-7820R to load a VI when the system powers on. The VI can then set the DIO lines to any power-on state.

All the DIO channels on Connectors 0 through 3 are routed with a 50 Ω characteristic trace impedance. Route all external circuitry with a similar impedance to ensure best signal quality. NI recommends performing signal integrity measurements to test the affect of signal routing with the cable and connection accessory for your application.

Installing Noise Suppression Ferrites



Caution To ensure the specified EMC performance, operate this product only with shielded cables and accessories. Do not use unshielded cables or accessories unless they are installed in a shielded enclosure with properly designed and shielded input/output ports and connected to the product using a shielded cable. If unshielded

cables or accessories are not properly installed and shielded, the EMC specifications for the product are no longer guaranteed.



Caution To ensure the specified EMC performance, install two (2) snap-on, ferrite beads (777297-01) per connected I/O cable in accordance with the product installation instructions.



Caution To ensure the specified EMC performance, the length of any cable connected to the input port(s) must be no longer than 3 m (10 ft).

For each connected I/O cable, install two (2) snap-on, ferrite beads (777297-01), one on each end of the cable, as close to the connector as practical.

Two (2) snap-on, ferrite beads (777297-01) are included in each of the following recommended cable kits:

- Shielded R Series High Speed Digital Cable, 1m (156166-01)
- Shielded R Series High Speed Digital Cable, 2m (156166-02)

For user-supplied cables, the ferrite beads can be ordered directly from NI by visiting ni.com/info and entering RDIO2FERRITE.

Figure 5. Ferrite Installation

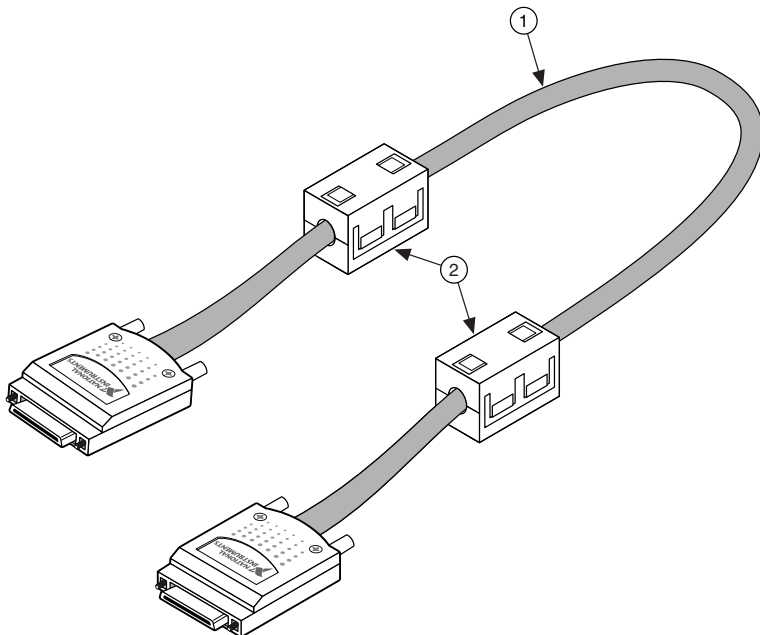

1. I/O cable
2. Ferrites

Where to Go Next

Refer to the following figure for information about other product tasks and associated resources for those tasks.

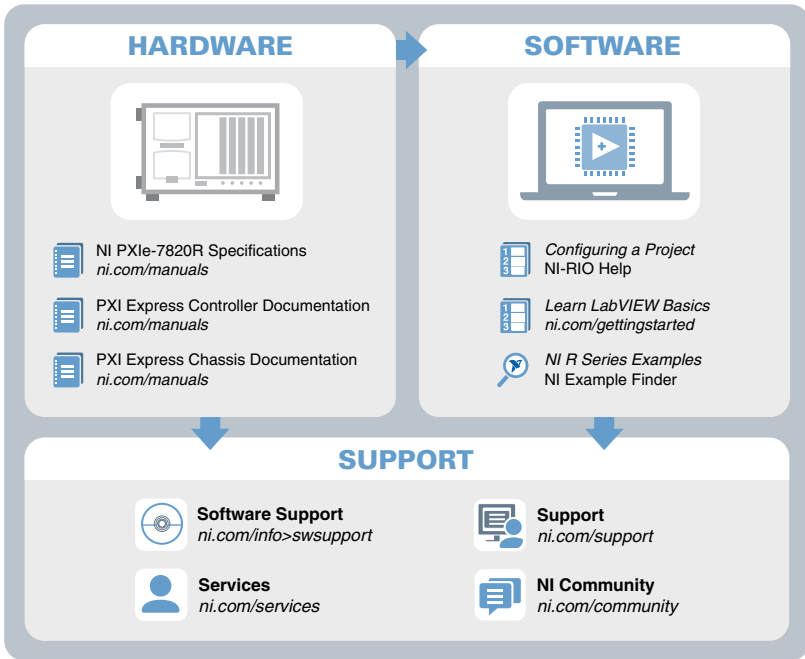

Where to Go for Support

The National Instruments website is your complete resource for technical support. At ni.com/support you have access to everything from troubleshooting and application development self-help resources to email and phone assistance from NI Application Engineers.

National Instruments corporate headquarters is located at 11500 North Mopac Expressway, Austin, Texas, 78759-3504. National Instruments also has offices located around the world to help address your support needs. For telephone support in the United States, create your service request at ni.com/support and follow the calling instructions or dial 512 795 8248. For telephone support outside the United States, visit the Worldwide Offices section of ni.com/global to access the branch office websites, which provide up-to-date contact information, support phone numbers, email addresses, and current events.

Refer to the *NI Trademarks and Logo Guidelines* at ni.com/trademarks for information on National Instruments trademarks. Other product and company names mentioned herein are trademarks or trade names of their respective companies. For patents covering National Instruments products/technology, refer to the appropriate location: **Help»Patents** in your software, the `patents.txt` file on your media, or the *National Instruments Patent Notice* at ni.com/patents. You can find information about end-user license agreements (EULAs) and third-party legal notices in the readme file for your NI product. Refer to the *Export Compliance Information* at ni.com/legal/export-compliance for the National Instruments global trade compliance policy and how to obtain relevant HTS codes, ECCNs, and other import/export data. NI MAKES NO EXPRESS OR IMPLIED WARRANTIES AS TO THE ACCURACY OF THE INFORMATION CONTAINED HEREIN AND SHALL NOT BE LIABLE FOR ANY ERRORS. U.S. Government Customers: The data contained in this manual was developed at private expense and is subject to the applicable limited rights and restricted data rights as set forth in FAR 52.227-14, DFAR 252.227-7014, and DFAR 252.227-7015.

© 2015 National Instruments. All rights reserved.

376820A-01 Feb15