

## COMPREHENSIVE SERVICES

We offer competitive repair and calibration services, as well as easily accessible documentation and free downloadable resources.

## SELL YOUR SURPLUS

We buy new, used, decommissioned, and surplus parts from every NI series. We work out the best solution to suit your individual needs.

 Sell For Cash  Get Credit  Receive a Trade-In Deal

## OBSOLETE NI HARDWARE IN STOCK & READY TO SHIP

We stock **New**, **New Surplus**, **Refurbished**, and **Reconditioned** NI Hardware.



*Bridging the gap between the manufacturer and your legacy test system.*

 1-800-915-6216

 [www.apexwaves.com](http://www.apexwaves.com)

 [sales@apexwaves.com](mailto:sales@apexwaves.com)

*All trademarks, brands, and brand names are the property of their respective owners.*

**Request a Quote**

 **CLICK HERE**

**AT-MIO-16F-5**

**Computer-Based  
Instruments**

# **Getting Started with Your PCI/PXI-6810 Serial Data Analyzer**

*High-Speed Serial Digital Transmission Devices for  
PCI and PXI Bus Computers*

January 1998 Edition  
Part Number 321754A-01

**Internet Support**

E-mail: [support@natinst.com](mailto:support@natinst.com)

FTP Site: <ftp.natinst.com>

Web Address: <http://www.natinst.com>

**Bulletin Board Support**

BBS United States: 512 794 5422

BBS United Kingdom: 01635 551422

BBS France: 01 48 65 15 59

**Fax-on-Demand Support**

512 418 1111

**Telephone Support (USA)**

Tel: 512 795 8248

Fax: 512 794 5678

**International Offices**

Australia 03 9879 5166, Austria 0662 45 79 90 0, Belgium 02 757 00 20, Brazil 011 288 3336,  
Canada (Ontario) 905 785 0085, Canada (Québec) 514 694 8521, Denmark 45 76 26 00,  
Finland 09 725 725 11, France 01 48 14 24 24, Germany 089 741 31 30, Hong Kong 2645 3186,  
Israel 03 6120092, Italy 02 413091, Japan 03 5472 2970, Korea 02 596 7456, Mexico 5 520 2635,  
Netherlands 0348 433466, Norway 32 84 84 00, Singapore 2265886, Spain 91 640 0085, Sweden 08 730 49 70,  
Switzerland 056 200 51 51, Taiwan 02 377 1200, United Kingdom 01635 523545

**National Instruments Corporate Headquarters**

6504 Bridge Point Parkway Austin, Texas 78730-5039 USA Tel: 512 794 0100

# Important Information

---

## Warranty

The PCI-6810 and PXI-6810 devices are warranted against defects in materials and workmanship for a period of one year from the date of shipment, as evidenced by receipts or other documentation. National Instruments will, at its option, repair or replace equipment that proves to be defective during the warranty period. This warranty includes parts and labor.

The media on which you receive National Instruments software are warranted not to fail to execute programming instructions, due to defects in materials and workmanship, for a period of 90 days from date of shipment, as evidenced by receipts or other documentation. National Instruments will, at its option, repair or replace software media that do not execute programming instructions if National Instruments receives notice of such defects during the warranty period. National Instruments does not warrant that the operation of the software shall be uninterrupted or error free.

A Return Material Authorization (RMA) number must be obtained from the factory and clearly marked on the outside of the package before any equipment will be accepted for warranty work. National Instruments will pay the shipping costs of returning to the owner parts which are covered by warranty.

National Instruments believes that the information in this manual is accurate. The document has been carefully reviewed for technical accuracy. In the event that technical or typographical errors exist, National Instruments reserves the right to make changes to subsequent editions of this document without prior notice to holders of this edition. The reader should consult National Instruments if errors are suspected. In no event shall National Instruments be liable for any damages arising out of or related to this document or the information contained in it.

EXCEPT AS SPECIFIED HEREIN, NATIONAL INSTRUMENTS MAKES NO WARRANTIES, EXPRESS OR IMPLIED, AND SPECIFICALLY DISCLAIMS ANY WARRANTY OF MERCHANTABILITY OR FITNESS FOR A PARTICULAR PURPOSE. CUSTOMER'S RIGHT TO RECOVER DAMAGES CAUSED BY FAULT OR NEGLIGENCE ON THE PART OF NATIONAL INSTRUMENTS SHALL BE LIMITED TO THE AMOUNT THEREFORE PAID BY THE CUSTOMER. NATIONAL INSTRUMENTS WILL NOT BE LIABLE FOR DAMAGES RESULTING FROM LOSS OF DATA, PROFITS, USE OF PRODUCTS, OR INCIDENTAL OR CONSEQUENTIAL DAMAGES, EVEN IF ADVISED OF THE POSSIBILITY THEREOF. This limitation of the liability of National Instruments will apply regardless of the form of action, whether in contract or tort, including negligence. Any action against National Instruments must be brought within one year after the cause of action accrues. National Instruments shall not be liable for any delay in performance due to causes beyond its reasonable control. The warranty provided herein does not cover damages, defects, malfunctions, or service failures caused by owner's failure to follow the National Instruments installation, operation, or maintenance instructions; owner's modification of the product; owner's abuse, misuse, or negligent acts; and power failure or surges, fire, flood, accident, actions of third parties, or other events outside reasonable control.

## Copyright

Under the copyright laws, this publication may not be reproduced or transmitted in any form, electronic or mechanical, including photocopying, recording, storing in an information retrieval system, or translating, in whole or in part, without the prior written consent of National Instruments Corporation.

## Trademarks

ComponentWorks™, CVI™, LabVIEW™, MITE™, NI-DAQ™, PXI™, and RTSI™ are trademarks of National Instruments Corporation.

Product and company names listed are trademarks or trade names of their respective companies.

## WARNING REGARDING MEDICAL AND CLINICAL USE OF NATIONAL INSTRUMENTS PRODUCTS

National Instruments products are not designed with components and testing intended to ensure a level of reliability suitable for use in treatment and diagnosis of humans. Applications of National Instruments products involving medical or clinical treatment can create a potential for accidental injury caused by product failure, or by errors on the part of the user or application designer. Any use or application of National Instruments products for or involving medical or clinical treatment must be performed by properly trained and qualified medical personnel, and all traditional medical safeguards, equipment, and procedures that are appropriate in the particular situation to prevent serious injury or death should always continue to be used when National Instruments products are being used. National Instruments products are NOT intended to be a substitute for any form of established process, procedure, or equipment used to monitor or safeguard human health and safety in medical or clinical treatment.

# FCC/DOC Radio Frequency Interference Class A Compliance

---

This equipment generates and uses radio frequency energy and, if not installed and used in strict accordance with the instructions in this manual, may cause interference to radio and television reception. Classification requirements are the same for the Federal Communications Commission (FCC) and the Canadian Department of Communications (DOC). This equipment has been tested and found to comply with the following two regulatory agencies:

## Federal Communications Commission

This equipment has been tested and found to comply with the limits for a Class A digital device, pursuant to part 15 of the FCC Rules. These limits are designed to provide reasonable protection against harmful interference when the equipment is operated in a commercial environment. This equipment generates, uses, and can radiate radio frequency energy and, if not installed and used in accordance with the instruction manual, may cause harmful interference to radio communications. Operation of this equipment in a residential area is likely to cause harmful interference in which case the user will be required to correct the interference at his own expense.

**Notices to User:** *Changes or modifications not expressly approved by National Instruments could void the user's authority to operate the equipment under the FCC Rules.*

*This device complies with the FCC rules only if used with shielded interface cables of suitable quality and construction. National Instruments used such cables to test this device and provides them for sale to the user. The use of inferior or nonshielded interface cables could void the user's authority to operate the equipment under the FCC rules.*

If necessary, consult National Instruments or an experienced radio/television technician for additional suggestions. The following booklet prepared by the FCC may also be helpful: *Interference to Home Electronic Entertainment Equipment Handbook*. This booklet is available from the U.S. Government Printing Office, Washington, DC 20402.

## Canadian Department of Communications

This Class A digital apparatus meets all requirements of the Canadian Interference-Causing Equipment Regulations.

Cet appareil numérique de la classe A respecte toutes les exigences du Règlement sur le matériel brouilleur du Canada.

---

## About This Manual

Organization of This Manual .....	ix
Conventions Used in This Manual.....	x
National Instruments Documentation .....	xi
Related Documentation.....	xi
Customer Communication .....	xii

## Chapter 1

### Introduction

About the PCI/PXI-6810 .....	1-1
Hardware Description.....	1-1
Software Description .....	1-3
Instrument Driver.....	1-3
Utilities and Applications.....	1-3
Electronic Documentation.....	1-3
Using PXI with CompactPCI.....	1-4
What You Need to Get Started .....	1-5
Software Programming Choices .....	1-6
National Instruments Application Software .....	1-6
Driver Software .....	1-6
Optional Equipment.....	1-8
Unpacking .....	1-8

## Chapter 2

### Configuration and Installation

Configuring Your 6810 Device .....	2-1
Alternate Low-Voltage Power Switch.....	2-1
Software Installation .....	2-2
Installing the Software Development Environment .....	2-2
Installing the Run-Time-Only Environment .....	2-3
Hardware Installation.....	2-3

Using the 6810 Soft Front Panel to Configure Your Device.....	2-6
Selecting a Configuration.....	2-7
Testing Your Configuration .....	2-7
Help .....	2-7
What to Do Next.....	2-8

## **Chapter 3**

### **Hardware Overview**

Functional Overview .....	3-1
Functional Unit Descriptions .....	3-2
MITE ASIC .....	3-2
DAQ DIO ASIC .....	3-2
Numerically Controlled Oscillator (NCO) .....	3-2
Serial Data Processor .....	3-3
RS-232 Transceivers.....	3-3
RS-485 Transceivers.....	3-3
Adjustable Voltage Transceivers .....	3-3
Static Digital I/O.....	3-3

## **Chapter 4**

### **Signal Connections**

I/O Connector .....	4-1
I/O Connector Signal Connection Descriptions.....	4-3
Using External Power with the DIO Signals.....	4-4

## **Appendix A**

### **Specifications**

## **Appendix B**

### **Customer Communication**

## **Glossary**

## **Index**

## Figures

Figure 1-1.	The Relationship between the Programming Environment and the Instrument Driver.....	1-7
Figure 2-1.	PCI/PXI-6810 Configurable Switch.....	2-1
Figure 2-2.	PCI/PXI-6810 Switch Settings.....	2-2
Figure 2-3.	Soft Front Panel.....	2-6
Figure 3-1.	6810 Device Block Diagram .....	3-2
Figure 4-1.	I/O Connector Pin Assignments .....	4-2

## Tables

Table 1-1.	PXI-6810 J2 Pin Assignment .....	1-5
Table 4-1.	I/O Connector Signals .....	4-3



---

This manual describes the features, functions, and operation of the PCI-6810 and PXI-6810 devices.

The 6810 device serial data analyzer (SDA) generates and acquires serial data streams for many different test applications. The 6810 device can transmit and receive serial data up to 10 Mb/s on PCI and PXI bus computers, and can communicate to different standard and proprietary serial communication interfaces.

## Organization of This Manual

---

The *Getting Started with Your PCI/PXI-6810 Serial Data Analyzer* manual is organized as follows:

- Chapter 1, *Introduction*, describes the 6810 device; lists what you need to get started; describes software programming choices, optional equipment, and custom cables; and explains how to unpack and set up your 6810 device.
- Chapter 2, *Configuration and Installation*, explains how to configure and install the 6810 hardware and software, and how to use the 6810 soft front panel.
- Chapter 3, *Hardware Overview*, presents an overview of the hardware functions on your 6810 device and explains the operation of each functional unit.
- Chapter 4, *Signal Connections*, describes signal connections for the 6810 device.
- Appendix A, *Specifications*, lists the 6810 device specifications.
- Appendix B, *Customer Communication*, contains forms you can use to request help from National Instruments or to comment on our products and manuals.

- The *Glossary* contains an alphabetical list and description of terms used in this manual, including abbreviations, acronyms, metric prefixes, mnemonics, and symbols.
- The *Index* contains an alphabetical list of key terms and topics in this manual, including the page where you can find each one.

## Conventions Used in This Manual

---

The following conventions are used in this manual:

< >

Angle brackets containing numbers separated by an ellipses represent a range of values associated with a bit or signal name (for example, ACH<0..7>).

»

The » symbol leads you through nested menu items and dialog box options to a final action. For Example, the sequence **File»Page Setup»Options» Substitute Fonts** directs you to pull down the **File** menu, select the **Page Setup** item, select **Options**, and finally select the **Substitute Fonts** options from the last dialog box.

◆

The ◆ symbol indicates that the text following it applies only to a specific product, a specific operating system, or a specific software version.



This icon to the left of bold italicized text denotes a note, which alerts you to important information.



This icon to the left of bold italicized text denotes a caution, which advises you of precautions to take to avoid injury, data loss, or a system crash.



This icon to the left of bold italicized text denotes a warning, which advises you of precautions to take to avoid being electrically shocked.

**bold**

Bold text denotes menus, menu items, or dialog box buttons or options.

*italic*

Italic text denotes emphasis, a cross reference, or an introduction to a key concept. This font also denotes text for which you supply the appropriate word or value, such as in Windows 3.x.

***bold italic***

Bold italic text denotes a note, caution, or warning.

monospace

Text in this font denotes text or characters that are to be literally input from the keyboard, sections of code, programming examples, and syntax examples. This font is also used for the proper names of disk drives, paths, directories, programs, subprograms, subroutines, device

names, functions, variables, filenames and extensions, and for statements and comments taken from programs.

6810 device

6810 device refers to both the PCI-6810 and the PXI-6810 devices, unless otherwise noted.

SDA

SDA refers to the term *Serial Data Analyzer*.

## National Instruments Documentation

---

*Getting Started with Your PCI/PXI-6810 Serial Data Analyzer* is one piece of the documentation set for your system. You could have any of several types of manuals, depending on the hardware and software in your system. Use the different types of manuals you have as follows:

- Software documentation—You may have both application software and 6810 software documentation. National Instruments application software includes LabVIEW and LabWindows/CVI. After you set up your hardware system, use either the application software documentation, or the 6810 documentation to help you write your application. It may be helpful to look through the software documentation before you configure your hardware.
- Accessory installation guides or manuals—If you are using accessory products, read the terminal block and cable assembly installation guides or accessory board user manuals. They explain how to physically connect the relevant pieces of the system. Consult these guides when you are making your connections.

## Related Documentation

---

The following documents contain information that you may find helpful as you read this manual:

- Your computer's technical reference manual
- Setup and test document
- *Serial Data Analyzer Software Reference Manual*
- National Instruments Application Note 105, *Connector Options for the 6810 Serial Data Analyzer*
- National Instruments *PXI Specification*, rev. 1.0
- *PCI Specification*, ver. 2.1
- *PICMG CompactPCI 2.0 R2.1*

- LabVIEW documentation set
- LabWindows/CVI documentation set
- NI-DAQ documentation set
- PXI chassis and documentation (PXI bus systems only)
- Your computer (PCI bus systems only)

## Customer Communication

---

National Instruments wants to receive your comments on our products and manuals. We are interested in the applications you develop with our products, and we want to help if you have problems with them. To make it easy for you to contact us, this manual contains comment and configuration forms for you to complete. These forms are in Appendix B, *Customer Communication*, at the end of this manual.

# Introduction

---

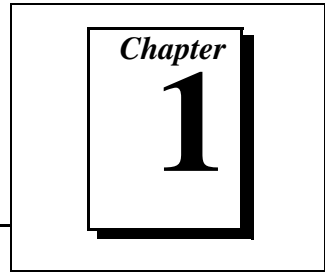

This chapter describes the 6810 device; lists what you need to get started; describes software programming choices, optional equipment, and custom cables; and explains how to unpack and set up your 6810 device.

## About the PCI/PXI-6810

---

### Hardware Description

The 6810 device is a general-purpose serial data analyzer (SDA) product for generating and acquiring serial data streams up to 10 Mb/s. It has two configurable channels to receive or transmit serial data, and you can combine the channels to provide a single transceiver channel. The 6810 device addresses the requirements of device functional testing in a laboratory, manufacturing, or repair center environment. Common applications include subsystem testing in cellular phones, wireless base stations, and CD-ROM drives, and essentially any application that involves arbitrary serial patterns.

Each serial channel incorporates sophisticated logic that generates a trigger in response to events. These triggers can direct the channel to transfer data to or from the host computer's memory, route to the Real-Time System Integration (RTSI) bus, or generate an external signal to trigger standalone instruments such as oscilloscopes or spectrum analyzers. Channels can trigger on such events as arbitrary pattern matches up to 64 bits long, rising and falling data edges, trigger stimulus from a RTSI bus, software triggers, or an external source.

The 6810 clock circuitry provides any bit frequency between 10 Hz and 10 MHz. The clock circuitry uses a numerically controlled oscillator with integral phase control to ensure stability and accuracy. The programmable clock produces a baud rate clock for serial transmission. The 6810 also accepts an external clock source up to 10 MHz for synchronous serial communication. To support asynchronous serial bit streams, the 6810 includes digital phase-lock

circuitry to synchronize the internal clock to an incoming asynchronous bit stream up to 2 Mb/s.

Each of the two serial channels in the 6810 is connected to a set of transceiver modules that accepts many common signal levels and that can be programmed for custom signal levels, if necessary. You can use the instrument driver to select all signal levels. The transceivers available to each 6810 serial channel are listed below:

- RS-485 differential transceivers
- RS-232 transceivers
- Programmable transceivers that adjust to any voltage range within  $\pm 10$  V to a resolution of 40 mV, including such common signal levels as 5 V TTL, 3.3 V, and ECL

The 6810 device also includes eight digital I/O signals for general-purpose input and output. You can use those I/O signals to control test signals on a device. These digital I/O signals normally operate with 5 V TTL characteristics, but they can also operate with an alternate power supply, for special low-voltage applications.

National Instruments provides many cabling options for the 6810 device to integrate it with your existing test systems. To assist you with building manufacturing test systems, National Instruments provides an application note that explains all the cable and connector options for the 6810 device, Application Note 105, *Connector Options for the 6810 Serial Data Analyzer*. Please contact the office nearest you, or call National Instruments for more information on obtaining this document.

## Software Description

You control the 6810 device with software consisting of four components. These components help you quickly build applications and learn the features of the instrument driver and hardware:

- SDA instrument driver software
- Configuration utility and soft front panel
- Example applications
- Online documentation

## Instrument Driver

With the instrument driver programming interface you have the flexibility to generate, acquire, and analyze arbitrary serial patterns of virtually any length, up to the limits of system memory. The instrument driver programming interface is object-oriented with simple functions and attributes. You can use it in the following application environments:

- LabVIEW
- LabWindows/CVI
- ComponentWorks
- Microsoft Visual C/C++
- Borland C/C++

## Utilities and Applications

Several example applications are provided with the instrument driver for common data patterns and metrics for generating and analyzing data. There is also a configuration utility for setting up your 6810 device. See the *Using the 6810 Soft Front Panel to Configure Your Device* section in Chapter 2, *Configuration and Installation*, for more information.

## Electronic Documentation

This manual, as well as the *Serial Data Analyzer Software Reference Manual*, are in Portable Document Format (PDF) on the same media as the software, and are installed automatically with the software. You can use this format to search electronically using links and jumps, or you can print it out if you prefer paper documentation. You will also find a `ReadMe.txt` file online, with important release information.

## Using PXI with CompactPCI

---

- ◆ **PXI-6810 only**  
Compatibility between PXI-compatible products and standard CompactPCI products is an important feature of the *PXI Specification*, revision 1.0. If you use a PXI-compatible plug-in device in a standard CompactPCI chassis, you will be unable to use PXI-specific functions, but you can still use the basic plug-in device functions. For example, the PXI trigger bus on your PXI-6810 device is available in a PXI chassis but not in a CompactPCI chassis.

The CompactPCI specification permits vendors to develop sub-buses that coexist with the basic PCI interface on the CompactPCI bus. Compatible operation is not guaranteed either between CompactPCI devices with different sub-buses or between CompactPCI devices with sub-buses and PXI. The standard implementation for CompactPCI does not include these sub-buses. Your PXI-6810 device will work in any standard CompactPCI chassis adhering to the *PICMG CompactPCI 2.0 R2.1* document.

PXI-specific features, the RTSI bus trigger, RTSI Clock, and Serial Communication are all implemented on the J2 connector of the CompactPCI bus. Table 1-1 lists the J2 pins used by your PXI-6810, which is compatible with any CompactPCI chassis with a sub-bus that does not drive these lines. Even if the sub-bus can drive these lines, the PXI-6810 is still compatible as long as those pins on the sub-bus are disabled by default and are never enabled.



**Caution:** *Damage to your equipment can occur if these lines are driven by the sub-bus.*



Table 1-1. PXI-6810 J2 Pin Assignment

PXI-6810 Signal	PXI Pin Name	CompactPCI J2 Pin Number
RTSI Trigger <0..5>	PXI Trigger <0..5>	B16, A16, A17, A18, B18, C18
RTSI Trigger 6	PXI Star	D17
RTSI Clock	PXI Trigger (7)	E16
Reserved	LBR (6, 7, 8, 9, 10, 11, 12)	E15, A3, C3, D3, E3, A2, B2

## What You Need to Get Started

---

To set up and use your 6810 device, you will need the following:

- PCI-6810 or PXI-6810 device
- Getting Started with Your PCI/PXI-6810 Serial Data Analyzer manual*
- 6810 Instrument Driver for Windows 95/NT
- Optional software packages and documentation:
  - LabVIEW
  - LabWindows/CVI
  - ComponentWorks
  - Microsoft Visual C/C++
- Your PCI computer running Windows 95 or Windows NT, ver. 4.0 or later, or your PXI chassis
- Serial Data Analyzer Software Reference Manual*

# Software Programming Choices

---

You have several options to choose from when programming your National Instruments SDA hardware. You can use National Instruments application software such as LabVIEW, LabWindows/CVI, ComponentWorks, with the National Instruments SDA instrument driver software. You can also use other third-party ADEs such as Borland C/C++ and Microsoft Visual C/C++ to interface the SDA software to standard Windows DLLs.

## National Instruments Application Software

LabVIEW features interactive graphics, a state-of-the-art user interface, and a powerful graphical programming language. The LabVIEW SDA VI Library, a series of virtual instruments (VIs) for using LabVIEW with National Instruments SDA hardware, is included with your software kit.

LabWindows/CVI features interactive graphics, a state-of-the-art user interface, and uses the ANSI standard C programming language. The LabWindows/CVI SDA Library, a series of functions for using LabWindows/CVI with National Instruments SDA hardware, is included with your software kit.

You can also use ComponentWorks, a state-of-the-art user interface and I/O component, compatible with many third-party ADEs.

## Driver Software

The Serial Data Analyzer instrument driver software is included at no charge with the 6810. The SDA driver software has an extensive library of functions that you can call from your application programming environment. These functions include transmitting and receiving serial data streams. The SDA instrument driver software performs all functions required for acquiring and saving serial data for analysis.

The SDA instrument driver software has functions for maximum flexibility and performance. Examples of high-level functions include those that acquire serial data analysis in single-shot or continuous mode to a file. An example of a low-level function is one that configures a serial data analysis sequence, since it requires advanced understanding of the 6810 device and serial data analysis.

The SDA instrument driver software also internally resolves many of the complex issues between the computer and the 6810 device, such as programming interrupts and DMA controllers. The SDA instrument driver software is the interface path between LabVIEW, LabWindows/CVI, or a conventional programming environment and the 6810 device.

Any platform that supports the SDA instrument driver integrates with NI-DAQ and a variety of National Instruments DAQ devices, so you can integrate your 6810 device and 6810 instrument driver development can integrate with National Instruments DAQ products.

Whether you are using conventional programming languages or National Instrument software, your application uses the driver software/API, as illustrated in Figure 1-1.

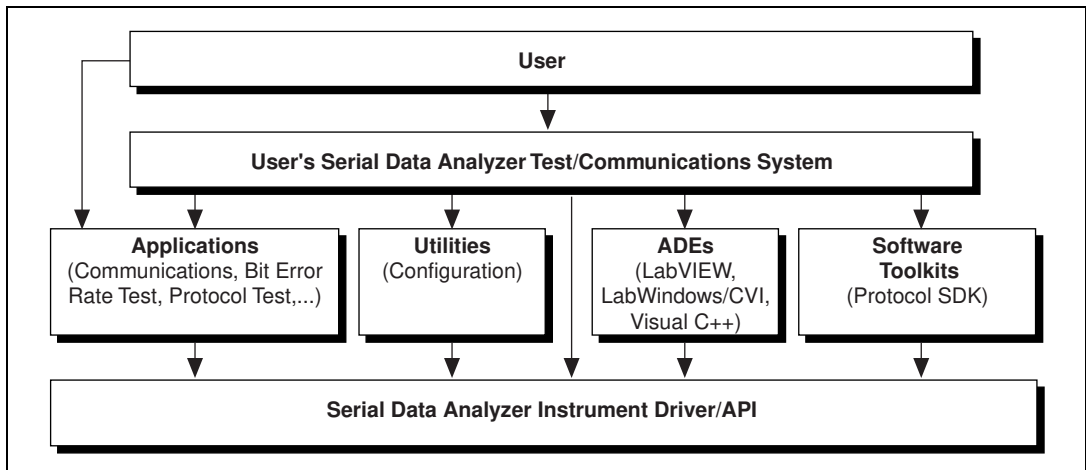

**Figure 1-1.** The Relationship between the Programming Environment and the Instrument Driver

## Optional Equipment

---

National Instruments offers a variety of products for use with your 6810 device, including cables, connector blocks, and other accessories, as follows:

- Cables and cable assemblies
- Software toolkits for different applications
- Breakout box for lab environments

For more information about optional equipment available from National Instruments, refer to your National Instruments catalogue or call the office nearest you. For specific application information, refer to the National Instruments Application Note 105, *Connector Options for the 6810 Serial Data Analyzer*.

## Unpacking

---

Your 6810 device is shipped in an antistatic package to prevent electrostatic damage to the device. Electrostatic discharge can damage several components on the device. To avoid such damage in handling the device, take the following precautions:

- Ground yourself via a grounding strap or by holding a grounded object.
- Touch the antistatic package to a metal part of your computer chassis before removing the device from the package.
- Remove the device from the package and inspect the device for loose components or any other signs of damage. Notify National Instruments if the device appears damaged in any way. Do *not* install a damaged device in your computer.

*Never* touch the exposed pins of connectors.

# Configuration and Installation

Chapter

2

This chapter explains how to configure and install the 6810 hardware and software, and how to use the 6810 soft front panel.

## Configuring Your 6810 Device

For most applications, the 6810 hardware is factory-configured for proper operation. You control and set up the 6810 features through the soft front panel.

### Alternate Low-Voltage Power Switch

By default, the hardware supplies its own internal 5 V power to these transceivers. The only user-selectable option on the 6810 hardware is a switch that supplies power to the eight general-purpose DIO signals from an external power source. See Figures 2-1 and 2-2 for the switch location and proper settings.

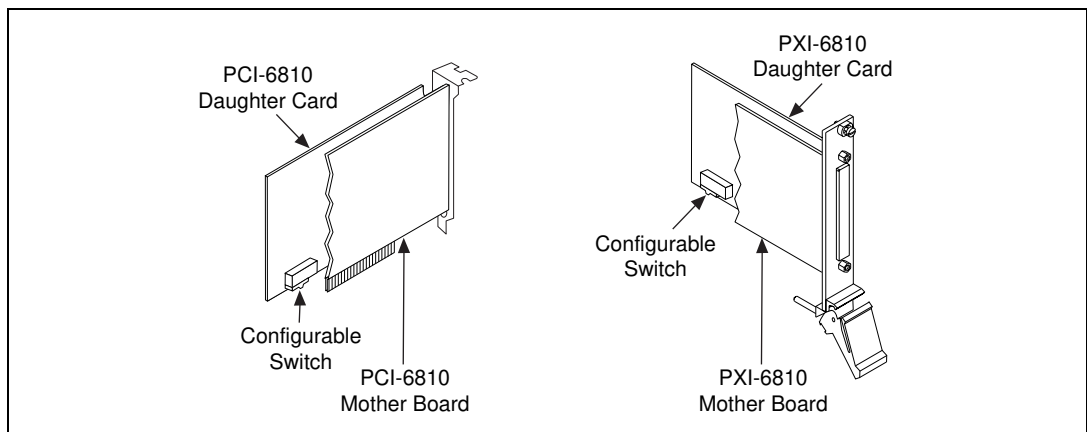
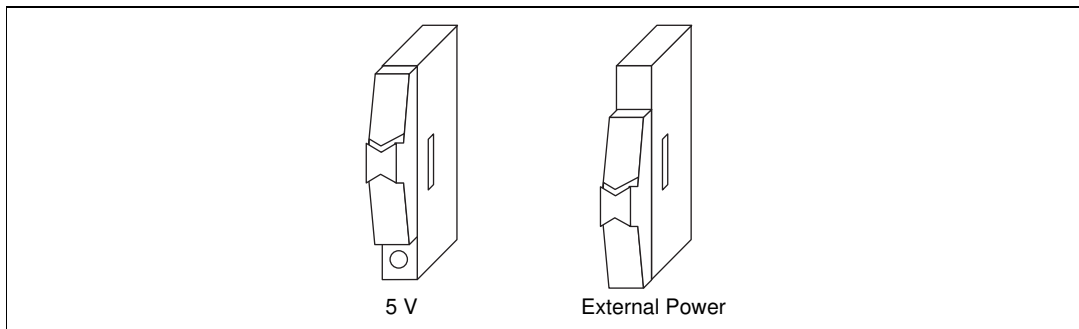

Figure 2-1. PCI/PXI-6810 Configurable Switch



**Figure 2-2.** PCI/PXI-6810 Switch Settings

See Chapter 4, *Signal Connections*, for more information on using the external power source.

## Software Installation

---



**Note:** *Install the 6810 driver software before installing your 6810 hardware.*

There are two different types of software environments for the 6810 device. They are each described in the following sections. Follow the option relevant to your work.

### Installing the Software Development Environment

Install your application development environment before installing the 6810 software. Then install your 6810 software by following these instructions.

1. Place the 6810 CD in your computer CD-ROM drive.
2. Open the CD-ROM window and click on **Setup**.
3. Follow the instructions on your screen, and select the **Software Development Environment** option.

## Installing the Run-Time-Only Environment

If you plan to use an existing application that uses the 6810 instrument driver, install your 6810 software by following these instructions.

1. Place the 6810 CD in your computer CD-ROM drive.
2. Open the CD-ROM window and click on **Setup**.
3. Follow the instructions on your screen, and select the **Run-Time Environment** option.

You have completed the software installation and are ready to install your hardware.

## Hardware Installation

---

### ◆ PCI-6810

You can install the PCI-6810 in any available PCI expansion slot in your PC. To achieve the best noise performance, leave as much room as possible between the PCI-6810 and other devices.

The following are general instructions for installing the PCI-6810. Consult your computer user manual or technical reference manual for specific instructions and warnings.

1. Plug in but do not turn on your computer before installing the PCI-6810 device. The power cord grounds the computer and protects it from electrical damage while you are installing the module.



**Warning:** *To protect both yourself and the computer from electrical hazards, your computer should remain off until you finish installing the PCI-6810 device.*

2. Remove the top cover or access port to the PCI bus.
3. Select any available PCI expansion slot.
4. Locate the metal bracket that covers the cut-out in the back panel of the computer for the slot you have selected. Remove and save the bracket-retaining screw and the bracket cover.
5. Touch the metal part of the power supply case inside the computer to discharge any static electricity that might be on your clothes or body.

6. Line up the PCI-6810 with the 68-pin connector near the cut-out on the back panel. Slowly push down on the top of the PCI-6810 until its card-edge connector is resting on the expansion slot receptacle. Using slow, evenly distributed pressure, press the PCI-6810 straight down until it seats in the expansion slot.
7. Reinstall the bracket-retaining screw to secure the PCI-6810 to the back panel rail.
8. Replace the computer cover.
9. Turn on your PC and the PCI-6810.



**Note:**

*If Windows 95/NT cannot identify your hardware, this probably means you installed the hardware before the software. If this is the case, install the software and reboot. This will allow Windows to recognize your hardware. If the problem persists, uninstall the software and hardware and reinstall in the correct order.*

10. Run the software soft front panel in the NI Serial Data Analyzer program group to verify it is working properly.

Your PCI-6810 device is installed. You are ready to configure your 6810 software. See the *Using the 6810 Soft Front Panel to Configure Your Device* section for software configuration instructions.

◆ **PXI-6810**

You can install the PXI-6810 in any available 5 V slot in your PXI or CompactPCI chassis. To achieve the best noise performance, leave as much room as possible between the 6810 and other devices.



**Note:**

*The PXI-6810 has connections to several reserved lines on the CompactPCI J2 connector. Before installing a PXI-6810 in a CompactPCI system that uses J2 connector lines for purposes other than PXI, see [Using PXI with CompactPCI in Chapter 1, Introduction](#), of this manual.*



1. Turn off your PXI or CompactPCI chassis.
2. Choose an unused PXI or CompactPCI 5 V peripheral slot. For maximum performance, install the PXI-6810 in a slot that supports bus arbitration or bus-master cards. The PXI-6810 contains onboard bus-master DMA logic that can operate only in such a slot. Do not choose a slot that does not support bus masters. PXI-compliant chassis must have bus arbitration for all slots.
3. Remove the filler panel for the peripheral slot you have chosen.
4. Touch a metal part on your chassis to discharge any static electricity that might be on your clothes or body.
5. Insert the PXI-6810 in the selected 5 V slot. Use the injector/ejector handle to fully inject the device into place.
6. Screw the front panel of the PXI-6810 to the front panel mounting rails of the PXI or CompactPCI chassis.
7. Visually verify the installation.
8. Plug in and turn on the PXI controller and your PXI-6810.

**Note:**

***If Windows 95/NT cannot identify your hardware, this probably means you installed the hardware before the software. If this is the case, install the software and reboot. This will allow Windows to recognize your hardware. If the problem persists, uninstall the software and hardware and reinstall in the correct order.***

9. Run the software soft front panel in the NI Serial Data Analyzer program group to verify it is working properly.

The PXI-6810 is installed. You are ready to configure your 6810 software. See the *Using the 6810 Soft Front Panel to Configure Your Device* section for software configuration instructions.

## Using the 6810 Soft Front Panel to Configure Your Device

To software-configure your 6810 device, follow these instructions:

1. Start the soft front panel application:
  - a. Go to **Start»Programs**.
  - b. From the **Programs** menu, choose **NI Serial Data Analyzer»Soft Front Panel**.
  - c. Choose the **Instrument** tab, as shown in Figure 2-3.
2. Select or test your configuration as described in the following sections.

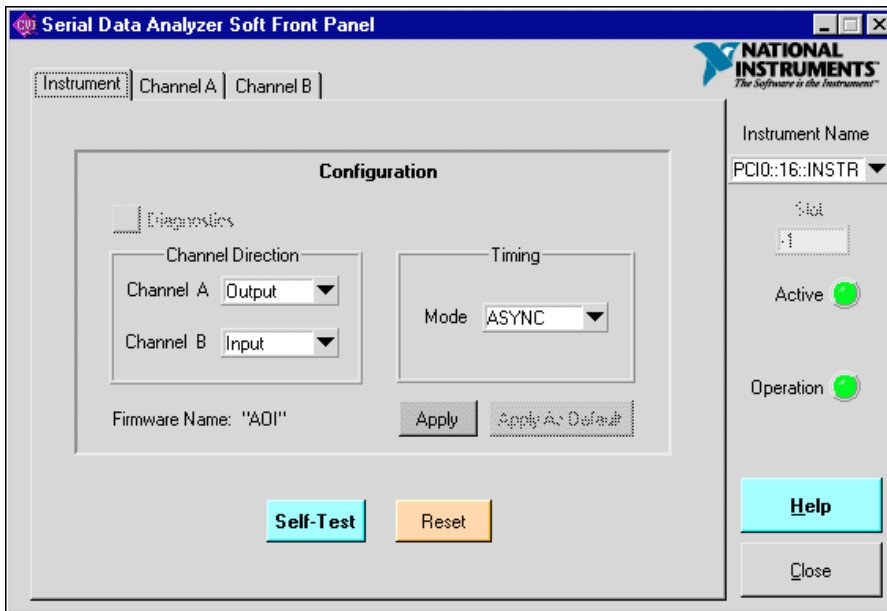

Figure 2-3. Soft Front Panel

## Selecting a Configuration

The current device is shown in the **Instrument Name** field. To configure a different device, select the appropriate option from the list shown in this field.

You can configure the programmable channel direction as either input or output. You can also set the timing mode as either synchronous or asynchronous. The defaults are Output for channel A and Input for channel B, as well as ASYNC timing mode. As you update your choices, the configuration program name is updated in the lower left corner of the screen next to the Firmware Name label.

To actually enable your new configuration, click on the **Apply** button. If you want your configuration to become the default configuration click on the **Apply as Default** button. When you have applied a new configuration, all the existing applications using the instrument driver will need to re-establish a connection (session) to the instrument. To do this, reinitialize all other instrument sessions. The channel panels in the soft front panel will be re-initialized, but the control contents will be preserved.

## Testing Your Configuration

From the **Instrument** tab of the soft front panel you can execute a self-test by clicking on the **Self-Test** button. This makes the instrument sequence into a series of tests to verify correct operation. It is equivalent to executing the function `niSda_self_test()`, as documented in the *Serial Data Analyzer Software Reference Manual*.

To reset your configuration, go to the **Instrument** tab and click on the **Reset** button. This executes the `niSda_reset()` function, as described in the *Serial Data Analyzer Software Reference Manual*. As in the case of the **Apply** configuration button, you must reopen all other instrument sessions to re-establish a connection (session) to the instrument..

## Help

To receive helpful information about the software operation and the software in general, press the **Help** button and follow the instructions there.

## What to Do Next

---

You have now installed your 6810 device and run the software to make sure it is working properly. The 6810 software includes information to help you quickly learn and use this product:

- Online documentation—The software reference manual as well as this getting started manual are available in PDF format for simple online viewing, or you can print all or parts of them, if you prefer.
- Example applications—The software distribution media includes several applications and their source code to show you how to use the 6810 for several common testing applications. These examples are commented for ease of use.

# Hardware Overview

---

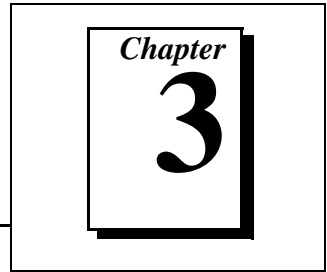

This chapter presents an overview of the hardware functions on your 6810 device and explains the operation of each functional unit.

## Functional Overview

---

The 6810 device uses reconfigurable technology that allows the instrument driver and soft front panel to alter the logical structure of the hardware. When the 6810 device powers on, all 6810 output is disabled except for the RS-232 transceivers, as required of RS-232 devices. Further, the onboard clock circuitry is disabled. After you either run the soft front panel or invoke an NI-SDA configuration function call from within your application, all the 6810 device hardware will operate as you specify.

Figure 3-1 shows the basic architecture of the 6810 device. The 6810 interfaces to the PCI bus with the National Instruments MITE ASIC. The MITE ASIC incorporates DMA controllers that enable the MITE to operate as a PCI bus master. The MITE can then move data rapidly and efficiently to and from system memory. This efficiency precludes the need for large data buffers on the device, but the 6810 does have some onboard buffering to accommodate PCI bus latencies.

Another ASIC on the 6810, the DAQ DIO, formats data into two 16-bit parallel data streams that then pass to the serial channels for conversion to or from serial transmission.

A key feature of the hardware is the independence of each serial channel. Each serial channel has its own dedicated serial hardware, transceivers, 16-bit data path in the DAQ DIO, and DMA controller in the MITE.

The block diagram in Figure 3-1 illustrates the key functional components of the 6810 device.

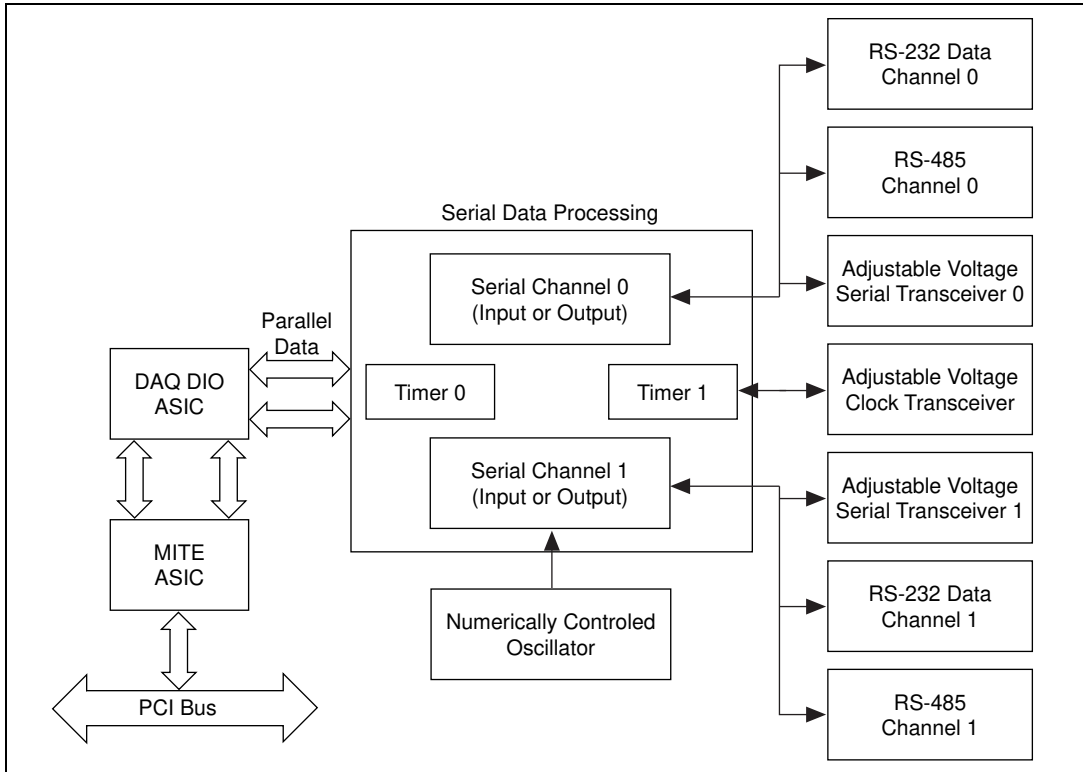

Figure 3-1. 6810 Device Block Diagram

## Functional Unit Descriptions

### MITE ASIC

The MITE ASIC serves as an interface to the PCI bus. It provides DMA controllers to transfer data to and from system memory.

### DAQ DIO ASIC

The DAQ DIO ASIC buffers and formats parallel data. It has two independent data paths, one dedicated to each serial channel.

### Numerically Controlled Oscillator (NCO)

Using the instrument driver, you can set the NCO to a frequency that divides down well to the bit rate for your application. The instrument driver will set up the NCO in response to your bit rate requirements.

## Serial Data Processor

The serial data processor is a reconfigurable FPGA that contains most of the 6810 hardware features. The processor is initially empty after system power-on. When you run the SDA soft front panel or use another SDA-based application, the 6810 instrument driver downloads the appropriate firmware into the serial processor. The processor supports two channels where a channel can be either input or output. A channel converts data between serial and parallel formats and incorporates trigger logic to control the serial channel.

## RS-232 Transceivers

Each channel has dedicated RS-232 transceivers. The Read Data (RD) signal is sensed when the associated channel is configured for input. The Transmit Data (TD) signal is driven when you configure the associated channel for output.

## RS-485 Transceivers

Each channel has a dedicated RS-485 transceiver. Each transceiver either transmits or receives data depending on the configuration of the associated serial channel.

## Adjustable Voltage Transceivers

These are also called general-purpose transceivers. These transceivers can either transmit or receive data, modulated at any voltage within  $\pm 10$  V to a resolution of 40 mV. Two transceivers are dedicated to the serial channels. A third transceiver is dedicated to an external clock. Depending on how you set up the clock source in the soft front panel, the clock transceiver either transmits the internal clock for use in external hardware, or receives a clock input from an external source.

## Static Digital I/O

The 6810 device has eight digital I/O signals for static input and output. You can use the signals to control external hardware or set up a device under test. The transceivers operate at either 5 V or low-voltage signal levels.

# Signal Connections

---

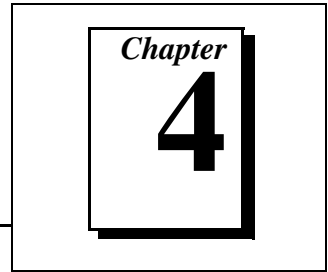

This chapter describes signal connections for the 6810 device.

## I/O Connector

---

The 6810 device has a single 68-pin connector. The pin configuration for the connector is shown in Figure 4-1.



EXT_PWR	34	68	GND
GND	33	67	Reserved
RX_TX1-	32	66	Reserved
RX_TX1+	31	65	GND
GND	30	64	Reserved
RX_TX_0-	29	63	Reserved
RX_TX_0+	28	62	GND
GND	27	61	Reserved
DIO(7)	26	60	Reserved
DIO(6)	25	59	GND
GND	24	58	Reserved
DIO(5)	23	57	Reserved
DIO(4)	22	56	Reserved
DIO(3)	21	55	GND
GND	20	54	Reserved
Reserved	19	53	Reserved
GND	18	52	Reserved
DIO(2)	17	51	Reserved
DIO(1)	16	50	GND
DIO(0)	15	49	GND
GND	14	48	Reserved
RTS1	13	47	Reserved
CTS1	12	46	GND
GND	11	45	Trig Out
RD1	10	44	Trig In
TD1	9	43	Reserved
RTS0	8	42	GND
CTS0	7	41	GND
RD0	6	40	DOE_CH0
TD0	5	39	GND
GPC	4	38	DOE_CH1
GPCH 1	3	37	GND
GPCH 0	2	36	GND
+5 V	1	35	Reserved

**Figure 4-1.** I/O Connector Pin Assignments



**Note:** *Do not connect anything to the reserved signals.*

## I/O Connector Signal Connection Descriptions

Table 4-1 describes each signal connection on the 68-pin connector.

**Table 4-1.** I/O Connector Signals

Pin	Signal Name	Description
19, 35, 43, 47–48, 51, 54, 56, 57–58, 60–61, 63–64, 66–67	Reserved	Reserved—Pins labeled as reserved are intended for future functionality from National Instruments. Do not connect anything to these signals.
34	EXT_PWR	External Power—Provides power to the GPIO transceivers for low-voltage test applications. Refer to the 6810 specifications for appropriate voltage levels.
11, 14, 18, 20, 24, 27, 30, 33, 36–37, 39, 41–42, 46, 49–50, 55, 59, 62, 65, 68	GND	Ground—These pins are connected to the ground signal.
28, 29	RX_TX_<0+..0->	An RS-485 Differential Pair—A single channel on the 6810 device can either transmit or receive data on a differential pair.
31, 32	RX_TX_<1+..1->	An RS-485 Differential Pair—A single channel on the 6810 device can either transmit or receive data on a differential pair.
15–17, 21–23, 25–26	DIO<0..7>	Digital I/O—These eight signals provide static digital input and output. The signals operate at 5 V TTL levels by default, but can support low-voltage operation by drawing power from the EXT_PWR signal.
8, 13	RTS<0..1>	Request to Send—An RS-232 handshaking signal driven by the 6810 device. The 6810 will assert this signal, per the RS-232 specification, whenever it is ready to receive serial data.
7, 12	CTS<0..1>	Clear to Send—An RS-232 handshaking signal received from a remote device. The 6810 device will generate serial data acquisition whenever handshaking is enabled and CTS is asserted, per the RS-232 specifications.
5, 9	TD<0..1>	Transmit Data—The 6810 transmits RS-232 serial data on these signals.
6, 10	RD<0..1>	Receive Data—The 6810 receives RS-232 serial data on these signals.
44, 45	Trig In, Trig Out	5 V TTL Trigger input and 5 V TTL Trigger output

**Table 4-1.** I/O Connector Signals (Continued)

Pin	Signal Name	Description
4	GPC	General-Purpose Clock—The 6810 either transmits or receives a clock signal depending on software configuration. The signal levels for the clock are the same as the general-purpose channel signals.
2–3	GPCH<0..1>	General-Purpose Serial Channel—Generates or receives serial data signals between $\pm 10$ V depending on whether the appropriate channel on the 6810 is configured for output or input.
38, 40	DOE_CH<0..1>	Drive Output Enable—This 5 V TTL active low signal asserts whenever the 6810 activates the signal drive circuitry data on the corresponding GPCH<1..0> signal. It provides the system integrator a means to control any external hardware that may be connected to the GPCH signals.
1	+5 V	+5 Volts—Power provided by the 6810 device.

## Using External Power with the DIO Signals

The 6810 device normally supplies 5 V power to its eight DIO signals. However, there may be cases where it is useful to operate these signals at other voltages. You can use the EXT power pin to supply a voltage between 2.0 V and 3.6 V to the DIO transceivers, and thereby change their output high and output low voltages. This feature is especially useful in testing portable equipment, such as devices that typically operate at low voltages. To use this feature, change the switch on the 6810. Figures 2-1 and 2-2 in Chapter 2, *Configuration and Installation*, depict the location of this switch on each 6810 device, and the correct position of the switch for the onboard 5 V supply or the external power source.

# Specifications

---

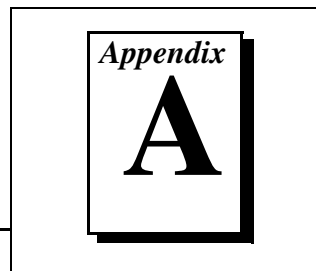

This appendix lists the 6810 device specifications. These specifications are typical at 25° C, unless otherwise stated.

## PCI-6810 and PXI-6810 Devices

### General Purpose Transceivers

#### Transmitter

Max synchronous bit rate .....10 Mb/s  
(Data must be synchronized to internal clock or external clock source)

Max asynchronous bit rate .....2 Mb/s

Signal range (typ) .....-10 to +10 V,  
±40 mV

Signal range (min) .....-9.5 to +9.5 V,  
±40 mV

Output impedance .....80 Ω

External clock-to-out (synchronous) ...40 ns

#### Receiver

Max synchronous bit rate .....10 Mb/s

Max asynchronous bit rate .....2 Mb/s

Setup/hold (synchronous) .....30 ns/5 ns

Programmable threshold range.....-9.5 to +9.5 V, ±100 mV

Absolute max input voltage .....+12 V

Input impedance .....>10 MΩ

Absolute min input voltage ..... -12 V

## RS-232 Interface

Signals supported ..... Read Data, Transmit Data, CTS, RTS (optional)

Handshake support ..... CTS/RTS (optional)

Max baud rate ..... 120 Kb/s

Output voltage range ..... -8 V (low)  
+8 V (high)

## RS-485 Transmitter

Interface signals ..... One differential pair per channel

Max baud rate ..... 10 Mb/s

Differential driver high voltage ..... 5 V (no load)  
2 V min (100  $\Omega$  load)  
1.5 V min (50  $\Omega$  load)

Differential input threshold ..... -0.2 min  
0.2 max

Receiver input hysteresis ..... 100 mV

## Digital I/O Interface

Number of transceivers ..... 8

Operating voltage ..... Switch-selectable between onboard 5 V and external power pin

## External Power Supply Requirements

Operating voltage ..... 2.7 to 3.6 V

## Operating Characteristics with External Power

Output high voltage .....	$V_{cc} - 0.2 \text{ V}$
Output low voltage .....	0.2 V ( $2.7 \text{ V} < V_{cc} < 3.6 \text{ V}$ ) 0.4 V ( $V_{cc} = 2.7, V_{cc} = 3.6 \text{ V}$ )
Output current.....	$\pm 12 \text{ mA}$

## Operating Characteristics at 5 V

Output high voltage .....	4.8 V min
Output low voltage .....	0.2 V max
Output current.....	$\pm 12 \text{ mA}$

## Serial Channel Triggering

Trigger inputs .....	Arbitrary pattern match (64 bit on input channel, 16 bit on output channel); data edge detection; RTSI trigger; External trigger signal; Trigger from another channel
Trigger combination .....	Any logical combination of two trigger inputs
Trigger output.....	External trigger signal; Acquire or transmit data; RTSI trigger; Trigger another serial channel
Post trigger timer .....	16-bit countdown timer that can clear a trigger condition. Timer can be reset in response to additional trigger inputs, or can ignore additional inputs until counter reaches zero.

## Interface

Initiator (master) capability .....	Supported
Target (slave) capability .....	Supported
PCI bus signal levels .....	5 V only

## Power Requirements

5 V .....	4.0 A
+12 V .....	100 mA
-12 V .....	50 mA

## Physical

PCI physical dimensions .....	10.7 by 17.5 cm (4.2 by 6.9 in.)
PXI physical dimensions .....	10.0 by 16.0 cm (3.9 by 6.3 in.)

## Environment

Operating temperature .....	0 to 50° C
Storage temperature .....	-20 to 70° C
Operating relative humidity .....	10 to 90% noncondensing
Storage relative humidity .....	5 to 95% noncondensing
Emissions .....	EN 55011:1991 Group 1 Class A at 10 m FCC Class A at 10 m

# Customer Communication

---

Appendix

**B**

For your convenience, this appendix contains forms to help you gather the information necessary to help us solve your technical problems and a form you can use to comment on the product documentation. When you contact us, we need the information on the Technical Support Form and the configuration form, if your manual contains one, about your system configuration to answer your questions as quickly as possible.

National Instruments has technical assistance through electronic, fax, and telephone systems to quickly provide the information you need. Our electronic services include a bulletin board service, an FTP site, a fax-on-demand system, and e-mail support. If you have a hardware or software problem, first try the electronic support systems. If the information available on these systems does not answer your questions, we offer fax and telephone support through our technical support centers, which are staffed by applications engineers.

## Electronic Services

### Bulletin Board Support

National Instruments has BBS and FTP sites dedicated for 24-hour support with a collection of files and documents to answer most common customer questions. From these sites, you can also download the latest instrument drivers, updates, and example programs. For recorded instructions on how to use the bulletin board and FTP services and for BBS automated information, call 512 795 6990. You can access these services at:

United States: 512 794 5422

Up to 14,400 baud, 8 data bits, 1 stop bit, no parity

United Kingdom: 01635 551422

Up to 9,600 baud, 8 data bits, 1 stop bit, no parity

France: 01 48 65 15 59

Up to 9,600 baud, 8 data bits, 1 stop bit, no parity

### FTP Support

To access our FTP site, log on to our Internet host, `ftp.natinst.com`, as anonymous and use your Internet address, such as `joesmith@anywhere.com`, as your password. The support files and documents are located in the `/support` directories.



## Fax-on-Demand Support

Fax-on-Demand is a 24-hour information retrieval system containing a library of documents on a wide range of technical information. You can access Fax-on-Demand from a touch-tone telephone at 512 418 1111.

## E-Mail Support (Currently USA Only)

You can submit technical support questions to the applications engineering team through e-mail at the Internet address listed below. Remember to include your name, address, and phone number so we can contact you with solutions and suggestions.

[support@natinst.com](mailto:support@natinst.com)

## Telephone and Fax Support

National Instruments has branch offices all over the world. Use the list below to find the technical support number for your country. If there is no National Instruments office in your country, contact the source from which you purchased your software to obtain support.

<b>Country</b>	<b>Telephone</b>	<b>Fax</b>
Australia	03 9879 5166	03 9879 6277
Austria	0662 45 79 90 0	0662 45 79 90 19
Belgium	02 757 00 20	02 757 03 11
Brazil	011 288 3336	011 288 8528
Canada (Ontario)	905 785 0085	905 785 0086
Canada (Quebec)	514 694 8521	514 694 4399
Denmark	45 76 26 00	45 76 26 02
Finland	09 725 725 11	09 725 725 55
France	01 48 14 24 24	01 48 14 24 14
Germany	089 741 31 30	089 714 60 35
Hong Kong	2645 3186	2686 8505
Israel	03 6120092	03 6120095
Italy	02 413091	02 41309215
Japan	03 5472 2970	03 5472 2977
Korea	02 596 7456	02 596 7455
Mexico	5 520 2635	5 520 3282
Netherlands	0348 433466	0348 430673
Norway	32 84 84 00	32 84 86 00
Singapore	2265886	2265887
Spain	91 640 0085	91 640 0533
Sweden	08 730 49 70	08 730 43 70
Switzerland	056 200 51 51	056 200 51 55
Taiwan	02 377 1200	02 737 4644
United Kingdom	01635 523545	01635 523154
United States	512 795 8248	512 794 5678

# Technical Support Form

Photocopy this form and update it each time you make changes to your software or hardware, and use the completed copy of this form as a reference for your current configuration. Completing this form accurately before contacting National Instruments for technical support helps our applications engineers answer your questions more efficiently.

If you are using any National Instruments hardware or software products related to this problem, include the configuration forms from their user manuals. Include additional pages if necessary.

Name \_\_\_\_\_

Company \_\_\_\_\_

Address \_\_\_\_\_

\_\_\_\_\_

Fax ( \_\_\_\_ ) \_\_\_\_\_ Phone ( \_\_\_\_ ) \_\_\_\_\_

Computer brand \_\_\_\_\_ Model \_\_\_\_\_ Processor \_\_\_\_\_

Operating system (include version number) \_\_\_\_\_

Clock speed \_\_\_\_\_ MHz RAM \_\_\_\_\_ MB Display adapter \_\_\_\_\_

Mouse \_\_\_yes \_\_\_no Other adapters installed \_\_\_\_\_

Hard disk capacity \_\_\_\_\_ MB Brand \_\_\_\_\_

Instruments used \_\_\_\_\_

\_\_\_\_\_

National Instruments hardware product model \_\_\_\_\_ Revision \_\_\_\_\_

Configuration \_\_\_\_\_

National Instruments software product \_\_\_\_\_ Version \_\_\_\_\_

Configuration \_\_\_\_\_

The problem is: \_\_\_\_\_

\_\_\_\_\_

\_\_\_\_\_

\_\_\_\_\_

\_\_\_\_\_

List any error messages: \_\_\_\_\_

\_\_\_\_\_

\_\_\_\_\_

The following steps reproduce the problem: \_\_\_\_\_

\_\_\_\_\_

\_\_\_\_\_

\_\_\_\_\_

\_\_\_\_\_

# PCI/PXI-6810 Hardware and Software Configuration Form

Record the settings and revisions of your hardware and software on the line to the right of each item. Complete a new copy of this form each time you revise your software or hardware configuration, and use this form as a reference for your current configuration. Completing this form accurately before contacting National Instruments for technical support helps our applications engineers answer your questions more efficiently.

## National Instruments Products

Hardware \_\_\_\_\_

National Instruments driver software version \_\_\_\_\_

Other devices in system \_\_\_\_\_

Other device software and version \_\_\_\_\_

## Other Products

Computer make and model \_\_\_\_\_

Microprocessor \_\_\_\_\_

Clock frequency or speed \_\_\_\_\_

PCI chipset \_\_\_\_\_

Type of video board installed \_\_\_\_\_

Operating system version \_\_\_\_\_

Operating system mode \_\_\_\_\_

Programming language \_\_\_\_\_

Programming language version \_\_\_\_\_

Other boards in system \_\_\_\_\_

Base I/O address of other boards \_\_\_\_\_

DMA channels of other boards \_\_\_\_\_

Interrupt level of other boards \_\_\_\_\_

# Documentation Comment Form

National Instruments encourages you to comment on the documentation supplied with our products. This information helps us provide quality products to meet your needs.

**Title:** *Getting Started with Your PCI/PXI-6810 Serial Data Analyzer*

**Edition Date:** January 1998

**Part Number:** 321754A-01

Please comment on the completeness, clarity, and organization of the manual.

---

---

---

---

---

---

---

---

If you find errors in the manual, please record the page numbers and describe the errors.

---

---

---

---

---

---

---

---

Thank you for your help.

Name \_\_\_\_\_

Title \_\_\_\_\_

Company \_\_\_\_\_

Address \_\_\_\_\_

\_\_\_\_\_

Phone (\_\_\_\_) \_\_\_\_\_ Fax (\_\_\_\_) \_\_\_\_\_

**Mail to:** Technical Publications  
National Instruments Corporation  
6504 Bridge Point Parkway  
Austin, TX 78730-5039

**Fax to:** Technical Publications  
National Instruments Corporation  
(512) 794-5678

<b>Prefix</b>	<b>Meaning</b>	<b>Value</b>
p-	pico-	$10^{-12}$
n-	nano-	$10^{-9}$
$\mu$ -	micro-	$10^{-6}$
m-	milli-	$10^{-3}$
k-	kilo-	$10^3$
M-	mega-	$10^6$
G-	giga-	$10^9$

## Numbers/Symbols

%	percent
+	positive of, or plus
-	negative of, or minus
/	per
°	degree
$\Omega$	ohm

## A

A	amperes
AC	alternating current
AC coupled	allowing the transmission of AC signals while blocking DC signals
A/D	analog-to-digital
ADC	analog-to-digital converter—an electronic device, often an integrated circuit, that converts an analog voltage to a digital number
address	character code that identifies a specific location (or series of locations) in memory
ADE	application development environment—examples of ADE are LabVIEW, LabWindows/CVI, Visual Basic, and Visual C++
amplification	a type of signal conditioning that improves accuracy in the resulting digitized signal and reduces noise
ANSI	American National Standards Institute
API	application programming interface
ASIC	Application-Specific Integrated Circuit—a proprietary semiconductor component designed and manufactured to perform a set of specific functions for a specific customer
asynchronous	(1) hardware—a property of an event that occurs at an arbitrary time, without synchronization to a reference clock (2) software—a property of a function that begins an operation and returns prior to the completion or termination of the operation
attenuate	to decrease the amplitude of a signal
attenuation ratio	the factor by which a signal's amplitude is decreased

**B**

b	bit—one binary digit, either 0 or 1
B	byte—eight related bits of data, an eight-bit binary number. Also used to denote the amount of memory required to store one byte of data.
bandwidth	the range of frequencies present in a signal, or the range of frequencies to which a measuring device can respond
base address	a memory address that serves as the starting address for programmable registers. All other addresses are located by adding to the base address.
baud rate	serial communications data transmission rate expressed in bits per second (b/s)
BCD	binary-coded decimal
binary	a number system with a base of 2
BIOS	basic input/output system—BIOS functions are the fundamental level of any PC or compatible computer. BIOS functions embody the basic operations needed for successful use of the computer's hardware resources.
bipolar	a signal range that includes both positive and negative values (for example, -5 to +5 V)
BNC	a type of coaxial signal connector
buffer	temporary storage for acquired or generated data (software)
burst-mode	a high-speed data transfer in which the address of the data is sent followed by back-to-back data words while a physical signal is asserted
bus	the group of conductors that interconnect individual circuitry in a computer. Typically, a bus is the expansion vehicle to which I/O or other devices are connected. Examples of PC buses are the AT bus, NuBus, Micro Channel, and EISA bus.
bus master	a type of a plug-in board or controller with the ability to read and write devices on the computer bus

## C

C	Celsius
cache	high-speed processor memory that buffers commonly used instructions or data to increase processing throughput
channel	pin or wire lead to which you apply or from which you read the analog or digital signal. Analog signals can be single-ended or differential. For digital signals, you group channels to form ports. Ports usually consist of either four or eight digital channels.
channel clock	the clock controlling the time interval between individual channel sampling within a scan. Boards with simultaneous sampling do not have this clock.
circuit trigger	a condition for starting or stopping clocks
clock	hardware component that controls timing for reading from or writing to groups
CMOS	complementary metal-oxide semiconductor
conversion device	device that transforms a signal from one form to another. For example, analog-to-digital converters (ADCs) for analog input, digital-to-analog converters (DACs) for analog output, digital input or output ports, and counter/timers are conversion devices.
conversion time	the time required, in an analog input or output system, from the moment a channel is interrogated (such as with a read instruction) to the moment that accurate data is available
counter/timer	a circuit that counts external pulses or clock pulses (timing)
coupling	the manner in which a signal is connected from one location to another
CPU	central processing unit
crosstalk	an unwanted signal on one channel due to an input on a different channel
current drive capability	the amount of current a digital or analog output channel is capable of sourcing or sinking while still operating within voltage range specifications



current sinking	the ability of an instrument to dissipate current for analog or digital output signals
current sourcing	the ability of an instrument to supply current for analog or digital output signals

## D

D/A	digital-to-analog
DAC	digital-to-analog converter—an electronic device, often an integrated circuit, that converts a digital number into a corresponding analog voltage or current
DAQ	data acquisition—(1) collecting and measuring electrical signals from sensors, transducers, and test probes or fixtures and inputting them to a computer for processing; (2) collecting and measuring the same kinds of electrical signals with A/D and/or DIO boards plugged into a computer, and possibly generating control signals with D/A and/or DIO boards in the same computer
dB	decibel—the unit for expressing a logarithmic measure of the ratio of two signal levels: $\text{dB} = 20\log_{10} V_1/V_2$ , for signals in volts
DC	direct current
DC coupled	allowing the transmission of both AC and DC signals
device	a plug-in instrument card or pad that can contain multiple channels and conversion devices. Plug-in boards and PCMCIA cards, which connects to your computer parallel port, are examples of devices.
digital trigger	a TTL level signal having two discrete levels—a high and a low level
DIN	Deutsche Industrie Norme
DIO	digital input/output
DMA	direct memory access—a method by which data can be transferred to/from computer memory from/to a device or memory on the bus while the processor does something else. DMA is the fastest method of transferring data to/from computer memory.
down counter	performing frequency division on an internal signal

DRAM	dynamic RAM
drivers	software that controls a specific hardware device such as a plug-in instrument or a GPIB interface board
dual-access memory	memory that can be sequentially accessed by more than one controller or processor but not simultaneously accessed. Also known as shared memory.
dual-ported memory	memory that can be simultaneously accessed by more than one controller or processor

## **E**

ECL	emitter-coupled logic
EEPROM	electrically erasable programmable read-only memory—ROM that can be erased with an electrical signal and reprogrammed
electrostatically coupled	propagating a signal by means of a varying electric field
EMC	electromechanical compliance
EPROM	erasable programmable read-only memory—ROM that can be erased (usually by ultraviolet light exposure) and reprogrammed
event	the condition or state of an analog or digital signal
external trigger	a voltage pulse from an external source that triggers an event such as an A/D conversion

## **F**

false triggering	triggering that occurs at an unintended time
fetch-and-deposit	a data transfer in which the data bytes are transferred from the source to the controller, and then from the controller to the target

FIFO	first-in first-out memory buffer—the first data stored is the first data sent to the acceptor. FIFOs are often used on DAQ devices to temporarily store incoming or outgoing data until that data can be retrieved or output. For example, an analog input FIFO stores the results of A/D conversions until the data can be retrieved into system memory, a process that requires the servicing of interrupts and often the programming of the DMA controller. This process can take several milliseconds in some cases. During this time, data accumulates in the FIFO for future retrieval. With a larger FIFO, longer latencies can be tolerated. In the case of analog output, a FIFO permits faster update rates, because the waveform data can be stored on the FIFO ahead of time. This again reduces the effect of latencies associated with getting the data from system memory to the DAQ device.
filtering	a type of signal conditioning that allows you to filter unwanted signals from the signal you are trying to measure
flyby	a type of high-performance data transfer in which the data bytes pass directly from the source to the target without being transferred to the controller
FPGA	Field Programmable Gate Array
ft	feet
<b>G</b>	
gain	the factor by which a signal is amplified, sometimes expressed in decibels
GPIB	General Purpose Interface bus, synonymous with HP-IB. The standard bus used for controlling electronic instruments with a computer. Also called IEEE 488 bus because it is defined by ANSI/IEEE Standards 488-1978, 488.1-1987, and 488.2-1987.
<b>H</b>	
h	hour
handle	pointer to a pointer to a block of memory; handles reference arrays and strings. An array of strings is a handle to a block of memory containing handles to strings.

handler	a device driver that is installed as part of the operating system of the computer
handshaked digital I/O	a type of digital acquisition/generation where a device or module accepts or transfers data after a digital pulse has been received. Also called latched digital I/O.
hardware	the physical components of a computer system, such as the circuit boards, plug-in boards, chassis, enclosures, peripherals, cables, and so on
hardware triggering	a form of triggering where you set the start time of an acquisition and gather data at a known position in time relative to a trigger signal
hex	hexadecimal
Hz	hertz—the number of scans read or updates written per second
<b>I</b>	
IC	integrated circuit
ID	identification
IDE	integrated development environment
IEEE	Institute of Electrical and Electronics Engineers
IEEE 488	the shortened notation for ANSI/IEEE Standards 488-1978, 488.1-1987, and 488.2-1987. See also GPIB.
immediate digital I/O	a type of digital acquisition/generation where LabVIEW updates the digital lines or port states immediately or returns the digital value of an input line. Also called nonlatched digital I/O.
in.	inches
Industrial Device Networks	standardized digital communications networks used in industrial automation applications; they often replace vendor-proprietary networks so that devices from different vendors can communicate in control systems
input bias current	the current that flows into the inputs of a circuit

input impedance	the measured resistance and capacitance between the input terminals of a circuit
input offset current	the difference in the input bias currents of the two inputs of an instrumentation amplifier
instrument driver	a set of high-level software functions that controls a specific plug-in, DAQ, PXI, GPIB, VXI, or RS-232 programmable instrument. Instrument drivers are available in several forms, ranging from a function callable language to a virtual instrument (VI) in LabVIEW.
instrumentation amplifier	a circuit whose output voltage with respect to ground is proportional to the difference between the voltages at its two inputs
interrupt	a computer signal indicating that the CPU should suspend its current task to service a designated activity
interrupt level	the relative priority at which a device can interrupt
I/O	input/output—the transfer of data to/from a computer system involving communications channels, operator interface devices, and/or data acquisition and control interfaces
IRQ	interrupt request
<b>K</b>	
k	kilo—the standard metric prefix for 1,000, or $10^3$ , used with units of measure such as volts, hertz, and meters
K	kilo—the prefix for 1,024, or $2^{10}$ , used with B in quantifying data or computer memory
<b>L</b>	
latched digital I/O	a type of digital acquisition/generation where a device or module accepts or transfers data after a digital pulse has been received. Also called handshaked digital I/O.
LED	light-emitting diode

library a file containing compiled object modules, each comprised of one of more functions, that can be linked to other object modules that make use of these functions. NISDA.LIB is a library that contains instrument driver functions. The NI-DAQ function set is broken down into object modules so that only the object modules that are relevant to your application are linked in, while those object modules that are not relevant are not linked.

LSB least significant bit

## M

m meters

M (1) Mega, the standard metric prefix for 1 million or  $10^6$ , when used with units of measure such as volts and hertz; (2) mega, the prefix for 1,048,576, or  $2^{20}$ , when used with B to quantify data or computer memory

MB megabytes of memory

MBLT eight-byte block transfers in which both the Address bus and the Data bus are used to transfer data

Mbytes/s a unit for data transfer that means 1 million or  $10^6$  bytes/s

memory buffer *See* buffer.

MIPS million instructions per second—the unit for expressing the speed of processor machine code instructions

MITE MXI Interfaces To Everything—a custom ASIC designed by National Instruments that implements the PCI bus interface. The MITE supports bus mastering for high speed data transfers over the PCI bus.

MS million samples

MSB most significant bit

MTBF mean time between failure

**N**

NCO	Numerically-Controlled Oscillator
NISDA	NI instrument driver for SDA cards
NIST	National Institute of Standards and Technology
nodes	execution elements of a block diagram consisting of functions, structures, and subVIs
noise	an undesirable electrical signal—Noise comes from external sources such as the AC power line, motors, generators, transformers, fluorescent lights, soldering irons, CRT displays, computers, electrical storms, welders, radio transmitters, and internal sources such as semiconductors, resistors, and capacitors. Noise corrupts signals you are trying to send or receive.
nonlatched digital I/O	a type of digital acquisition/generation where LabVIEW updates the digital lines or port states immediately or returns the digital value of an input line. Also called immediate digital I/O or non-handshaking.
nonreferenced signal sources	signal sources with voltage signals that are not connected to an absolute reference or system ground. Also called floating signal sources. Some common example of nonreferenced signal sources are batteries, transformers, or thermocouples.

**O**

onboard channels	channels provided by the plug-in DAQ board
onboard RAM	optional RAM usually installed into SIMM slots
operating system	base-level software that controls a computer, runs programs, interacts with users, and communicates with installed hardware or peripheral devices
optical coupler, optocoupler	a device designed to transfer electrical signals by utilizing light waves to provide coupling with electrical isolation between input and output. Sometimes called optoisolator or photocoupler.
optical isolation	the technique of using an optoelectric transmitter and receiver to transfer data without electrical continuity, to eliminate high-potential differences and transients

OUT	output pin—a counter output pin where the counter can generate various TTL pulse waveforms
output settling time	the amount of time required for the analog output voltage to reach its final value within specified limits
output slew rate	the maximum rate of change of analog output voltage from one level to another

## P

pattern generation	a type of handshaked (latched) digital I/O in which internal counters generate the handshaked signal, which in turn initiates a digital transfer. Because counters output digital pulses at a constant rate, this means you can generate and retrieve patterns at a constant rate because the handshaked signal is produced at a constant rate.
PC Card	a credit-card-sized expansion card that fits in a PCMCIA slot, often referred to as a PCMCIA card
PCI	Peripheral Component Interconnect—a high-performance expansion bus architecture originally developed by Intel to replace ISA and EISA. It is achieving widespread acceptance as a standard for PCs and work-stations; it offers a theoretical maximum transfer rate of 132 Mbytes/s.
PCI-MITE	is a custom ASIC designed by National Instruments that implements the PCI bus interface. The PCI-MITE supports bus mastering for high speed data transfers over the PCI bus. It is also used in PXI cards.
PCMCIA	an expansion bus architecture that has found widespread acceptance as a <i>de facto</i> standard in notebook-size computers. It originated as a specification for add-on memory cards written by the Personal Computer Memory Card International Association.
pipeline	a high-performance processor structure in which the completion of an instruction is broken into its elements so that several elements can be processed simultaneously from different instructions
Plug and Play devices	devices that do not require DIP switches or jumpers to configure resources on the devices—also called switchless devices



port	(1) a communications connection on a computer or a remote controller (2) a digital port, consisting of four or eight lines of digital input and/or output
posttriggering	the technique used on an instrument to acquire a programmed number of samples after trigger conditions are met
ppm	parts per million
pretriggering	the technique used on an instrument to keep a continuous buffer filled with data, so that when the trigger conditions are met, the sample includes the data leading up to the trigger condition
propagation	the transmission of a signal through a computer system
propagation delay	the amount of time required for a signal to pass through a circuit
protocol	the exact sequence of bits, characters, and control codes used to transfer data between computers and peripherals through a communications channel.
pts	points
pulse trains	multiple pulses
pulsed output	a form of counter signal generation by which a pulse is outputted when a counter reaches a certain value
PXI	Stands for PCI eXtensions for Instrumentation. PXI is an open specification that builds off the CompactPCI specification by adding instrumentation-specific features.

## R

RAM	random-access memory
RD	Read Data signal
real time	a property of an event or system in which data is processed as it is acquired instead of being accumulated and processed at a later time
resolution	the smallest signal increment that can be detected by a measurement system. Resolution can be expressed in bits, in proportions, or in a

	percentage of full scale. For example, a system has 12-bit resolution, one part in 4,096 resolution, and 0.0244% full scale.
retry	an acknowledge by a destination that signifies that the cycle did not complete and should be repeated
ribbon cable	a flat cable in which the conductors are side by side
rise time	the difference in time between the 10% and 90% points of a system's step response
rms	root mean square—the square root of the average value of the square of the instantaneous signal amplitude; a measure of signal amplitude
ROM	read-only memory
RTSI bus	real-time system integration bus—the National Instruments timing bus that connects instruments directly, by means of connectors on top of the boards, for precise synchronization of functions
<b>S</b>	
s	seconds
S	samples
sample counter	the clock that counts the output of the channel clock, in other words, the number of samples taken. On boards with simultaneous sampling, this counter counts the output of the scan clock and hence the number of scans.
scan	one or more analog or digital input samples. Typically, the number of input samples in a scan is equal to the number of channels in the input group. For example, one pulse from the scan clock produces one scan which acquires one new sample from every analog input channel in the group.
scan clock	the clock controlling the time interval between scans. On boards with interval scanning support (for example, the AT-MIO-16F-5), this clock gates the channel clock on and off. On boards with simultaneous sampling (for example, the EISA-A2000), this clock clocks the track-and-hold circuitry.

scan rate	the number of scans per second. For example, a scan rate of 10 Hz means sampling each channel 10 times per second.
SCXI	Signal Conditioning eXtensions for Instrumentation—the National Instruments product line for conditioning low-level signals within an external chassis near sensors so only high-level signals are sent to instruments in the noisy PC environment
SDA	Serial Data Analyzer
SDK	software development kit
settling time	the amount of time required for a voltage to reach its final value within specified limits
shared memory	<i>See</i> dual-access memory
signal conditioning	the manipulation of signals to prepare them for digitizing
signal divider	performing frequency division on an external signal
SIMM	single in-line memory module
SMB	a type of miniature coaxial signal connector
SNR	signal-to-noise ratio—the ratio of the overall rms signal level to the rms noise level, expressed in decibels
software trigger	a programmed event that triggers an event such as data acquisition
software triggering	a method of triggering in which you simulate an analog trigger using software. Also called conditional retrieval.
source impedance	a parameter of signal sources that reflects current-driving ability of voltage sources (lower is better) and the voltage-driving ability of current sources (higher is better)
SOURCE input pin	an counter input pin where the counter counts the signal transitions
S/s	samples per second—used to express the rate at which an instrument samples an analog signal
statically configured device	a device whose logical address cannot be set through software; that is, it is not dynamically configurable

switchless device	devices that do not require DIP switches or jumpers to configure resources on the devices—also called Plug and Play devices
synchronous	(1) hardware—a property of an event that is synchronized to a reference clock (2) software—a property of a function that begins an operation and returns only when the operation is complete
system RAM	RAM installed on a personal computer and used by the operating system, as contrasted with onboard RAM
system noise	a measure of the amount of noise seen by an analog circuit or an ADC when the analog inputs are grounded

## T

TC	terminal count—the highest value of a counter
TD	Transmit Data signal
throughput rate	the data, measured in bytes/s, for a given continuous operation, calculated to include software overhead. Throughput Rate = Transfer Rate/Software Overhead Factor.
top-level VI	VI at the top of the VI hierarchy. This term is used to distinguish the VI from its subVIs.
transducer	<i>See</i> sensor
transducer excitation	a type of signal conditioning that uses external voltages and currents to excite the circuitry of a signal conditioning system into measuring physical phenomena
transfer rate	the rate, measured in bytes/s, at which data is moved from source to destination after software initialization and set up operations; the maximum rate at which the hardware can operate
trigger	any event that causes or starts some form of data capture
TTL	transistor-transistor logic

**U**

UART	universal asynchronous receiver/transmitter—an integrated circuit that converts parallel data to serial data (and vice versa), commonly used as a computer bus to serial device interface for serial communication
UI	update interval
unipolar	a signal range that is always positive (for example, 0 to +10 V)
update	the output equivalent of a scan. One or more analog or digital output samples. Typically, the number of output samples in an update is equal to the number of channels in the output group. For example, one pulse from the update clock produces one update that sends one new sample to every analog output channel in the group.
update rate	the number of output updates per second

**V**

V	volts
$V_{DC}$	volts direct current
VDMAD	virtual DMA driver
VI	virtual instrument—(1) a combination of hardware and/or software elements, typically used with a PC, that has the functionality of a classic stand-alone instrument (2) a LabVIEW software module (VI), which consists of a front panel user interface and a block diagram program
$V_{IH}$	volts, input high
$V_{IL}$	volts, input low
$V_{in}$	volts in
VISA	virtual instrument software architecture—a new driver software architecture developed by National Instruments to unify instrumentation software GPIB, DAQ, and VXI. It has been accepted as a standard for VXI by the VXIplug&play Systems Alliance.
visual basic custom	a specific form of binary packaged object that can be created by

## *Glossary*

control (VBXs)                    different companies and integrated into applications written using Visual Basic

$V_{OH}$                                 volts, output high

$V_{OL}$                                 volts, output low

VPICD                                virtual programmable interrupt controller device

$V_{ref}$                                 reference voltage

## **W**

waveform                         multiple voltage readings taken at a specific sampling rate

wire                                 data path between nodes

word                                the standard number of bits that a processor or memory manipulates at one time. Microprocessors typically use 8, 16, or 32-bit words.

working voltage                 the highest voltage that should be applied to a product in normal use, normally well under the breakdown voltage for safety margin. See also Breakdown Voltage.

## Numbers

5 V, operating characteristics, A-4  
+5 V signal (table), 4-4

## A

adjustable voltage transceivers, 3-3  
alternate low-voltage power switch, 2-1 to 2-2  
application examples, 2-8

## B

bulletin board support, B-1

## C

cabling options, 1-2  
clock circuitry, 1-1 to 1-2  
clock specifications, A-1  
    external clock, A-1  
    internal clock, A-1  
CompactPCI  
    J2 pin assignments (table), 1-5  
    using with PXI, 1-4  
CompactPCI Specification, 1-4  
ComponentWorks software, 1-6  
configuration. *See also* installation.  
    alternate low-voltage power switch,  
        2-1 to 2-2  
    using 6810 Soft Front Panel, 2-6 to 2-7  
CTS<0..1> signal (table), 4-3  
customer communication, *xii*, B-1 to B-2

## D

DAQ DIO ASIC, 3-1, 3-2  
development environment, installing, 2-2  
digital I/O  
    overview, 1-2  
    static, 3-3  
digital I/O interface specifications, A-3 to A-4  
    external power supply requirements, A-3  
    operating characteristics at 5 V, A-4  
    operating characteristics with external  
        power, A-3  
DIO<0..7> signals (table), 4-3  
documentation  
    conventions used in manual, *x-xi*  
    electronic documentation, 1-3  
    example applications, 2-8  
    National Instruments documentation, *xi*  
    online documentation, 2-8  
    organization of manual, *ix-x*  
    related documentation, *xi-xii*  
DOE\_CH<0..1> signal (table), 4-4  
driver software, 1-6 to 1-7

## E

e-mail support, B-2  
electronic documentation, 1-3  
electronic support services, B-1 to B-2  
environment specifications, A-5  
equipment, optional, 1-8  
example applications, 2-8  
external clock specifications, A-1

external power  
  for digital I/O interface  
    operating characteristics, A-3  
    requirements, A-3  
  EXT pin for supplying, 4-4  
EXT\_PWR signal (table), 4-3

## F

fax and telephone support numbers, B-2  
Fax-on-Demand support, B-2  
FTP support, B-1

## G

general purpose transceivers  
  description, 3-3  
  specifications  
    receiver, A-2  
    transmitter, A-2  
GND signal (table), 4-3  
GPC signal (table), 4-4  
GPCH<0..1> signal (table), 4-4

## H

hardware  
  description, 1-1 to 1-2  
  functional overview, 3-1 to 3-3  
    adjustable voltage transceivers, 3-3  
    block diagram, 3-2  
    DAQ DIO ASIC, 3-2  
    MITE ASIC, 3-2  
    numerically controlled oscillator  
      (NCO), 3-2  
    RS-232 transceivers, 3-3  
    RS-485 transceivers, 3-3

  serial data processor, 3-3  
  static digital I/O, 3-3  
  installation, 2-3 to 2-5

## I

I/O connector  
  pin assignments (figure), 4-2  
  signal descriptions (table), 4-3 to 4-4  
installation. *See also* configuration.  
  hardware installation, 2-3 to 2-5  
    PCI-6810, 2-3 to 2-4  
    PXI-6810, 2-4 to 2-5  
  software installation, 2-2 to 2-3  
    development environment, 2-2  
    run-time-only environment, 2-3  
  unpacking PCI/PXI-6810, 1-8  
instrument driver. *See* Serial Data Analyzer  
  instrument driver.  
internal clock specifications, A-1

## J

J2 connector  
  damage to equipment by sub-bus driven  
    lines (caution), 1-4  
  pin assignments (table), 1-5

## L

LabVIEW and LabWindows/CVI  
  software, 1-6  
low-voltage power switch, alternate, 2-1 to 2-2

## M

manual. *See* documentation.  
MITE ASIC, 3-1, 3-2



**N**

numerically controlled oscillator (NCO), 3-2

**P****PCI/PXI-6810**

- hardware description, 1-1 to 1-2
- optional equipment, 1-8
- requirements for getting started, 1-5
- software description, 1-3
- software programming choices, 1-6 to 1-7
  - driver software, 1-6 to 1-7
  - National Instruments application software, 1-6
- unpacking, 1-8
- using with CompactPCI, 1-4 to 1-5
  - J2 pin assignments (table), 1-5

physical specifications, A-5

pin assignments

- I/O connector (figure), 4-2
- J2 connector (table), 1-5

power, external. *See* external power.

power requirement specifications, A-5

power switch, low-voltage, 2-1 to 2-2

- PCI/PXI-6810 configurable switch (figure), 2-1

- PCI/PXI-6810 switch settings (figure), 2-2

PXI Specification, 1-4

**R**

RD<0..1> signal (table), 4-3

receiver transceiver specifications, A-2

requirements for getting started, 1-5

RS-232 transceivers

- overview, 3-3
- specifications, A-2

RS-485 transceivers

- overview, 3-3
- specifications, A-3

RTS<0..1> signal (table), 4-3

run-time-only environment, installing, 2-3

RX\_TX\_<0+..0-> signal (table), 4-3

RX\_TX\_<1+..1-> signal (table), 4-3

**S**

serial channel triggering specifications, A-4

Serial Data Analyzer instrument driver

- compatibility with application software, 1-3
- software description, 1-6 to 1-7

serial data processor, 3-3

signal connections, 4-1 to 4-4

I/O connector

- pin assignments (figure), 4-2
- signal descriptions (table), 4-3 to 4-4
- using external power with DIO signals, 4-4

Soft Front Panel application, 2-6 to 2-7

getting help, 2-7

illustration, 2-6

selecting configuration, 2-7

starting, 2-6

testing configuration, 2-7

software description

- electronic documentation, 1-3
- instrument driver, 1-3
- utilities and applications, 1-3

software installation, 2-2 to 2-3

development environment, 2-2

run-time-only environment, 2-3

software programming choices, 1-6 to 1-7

driver software, 1-6 to 1-7

- National Instruments application software, 1-6

specifications

- clock, A-1
  - external clock, A-1
  - internal clock, A-1

- digital I/O interface, A-3 to A-4
  - external power supply requirements, A-3
  - operating characteristics at 5 V, A-4
  - operating characteristics with external power, A-3
- environment, A-5
- general purpose transceivers
  - receiver, A-2
  - transmitter, A-2
- interface
  - PCI devices, A-5
  - PXI devices, A-5
- physical, A-5
- power requirements, A-5
- RS-232 transceiver, A-2
- RS-485 transceiver, A-3
- serial channel triggering, A-4
- static digital I/O, 3-3
- switch, low-voltage, 2-1 to 2-2
  - PCI/PXI-6810 configurable switch (figure), 2-1
  - PCI/PXI-6810 switch settings (figure), 2-2

## T

- TD<0..1> signal (table), 4-3
- technical support, B-1 to B-2
- telephone and fax support numbers, B-2
- transceivers
  - adjustable voltage (general purpose) description, 3-3
  - specifications, A-2
  - overview, 1-2
  - RS-232, 3-3
  - RS-485, 3-3
- transmitter transceiver specifications, A-2
- triggering specifications, serial channel, A-4

## U

- unpacking PCI/PXI-6810, 1-8
- utilities and applications, 1-3