

COMPREHENSIVE SERVICES

We offer competitive repair and calibration services, as well as easily accessible documentation and free downloadable resources.

SELL YOUR SURPLUS

We buy new, used, decommissioned, and surplus parts from every NI series. We work out the best solution to suit your individual needs.

 Sell For Cash  Get Credit  Receive a Trade-In Deal

OBSOLETE NI HARDWARE IN STOCK & READY TO SHIP

We stock **New**, **New Surplus**, **Refurbished**, and **Reconditioned** NI Hardware.



Bridging the gap between the manufacturer and your legacy test system.

 1-800-915-6216

 www.apexwaves.com

 sales@apexwaves.com

All trademarks, brands, and brand names are the property of their respective owners.

Request a Quote

 **CLICK HERE**

CP500X

PRODUCT FLYER

Oscilloscopes

CONTENTS

[PXI Oscilloscope Portfolio Overview](#)

[Oscilloscope Probes](#)

[8-Bit PXI Oscilloscopes: Optimized for Cost or Speed](#)

[10-Bit and 12-Bit PXI Oscilloscopes: Optimized for Speed, Resolution, and Density](#)

[14-Bit PXI Oscilloscopes: Optimized for Resolution and Density](#)

[24-Bit PXI Oscilloscope: Flexible Resolution](#)

[Platform-Based Approach to Test and Measurement](#)

[PXI Instrumentation](#)

[Hardware Services](#)

PXI Oscilloscope Portfolio Overview

NI offers a wide range of oscilloscope options with variable bandwidths, sample rates, ADC resolutions, voltage ranges, and channel densities. Since all NI PXI Oscilloscopes use the same software driver, models can be mixed and matched to optimize performance and cost for your application's mixed needs.

8-Bit Scopes: Optimized for Cost or Speed



10-Bit and 12-Bit Scopes: Optimized for Speed, Resolution, and Density

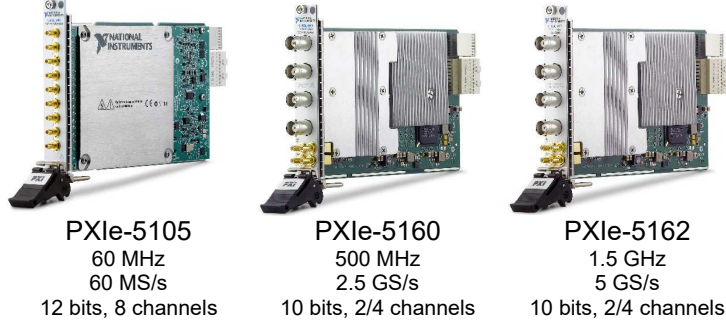

14-Bit Scopes: Optimized for Resolution and Density



24-Bit Scope: Flexible Resolution



* = Programmable FPGA

Oscilloscope Probes

An oscilloscope probe is a fundamental part of an analog measurement system. Without an appropriate probe, the best oscilloscope is useless. For that reason, it is essential to choose the right probe to connect the circuit under test to your oscilloscope. Passive probes have the most widespread use in application and are comprised of only passive circuit elements. Active probes are ideal in cases where extremely low capacitance is required for high-frequency measurements or a measurement needs isolation from a given ground reference. Current probes are ideal for applications that require looking at a current signal in relation to a voltage line. For more information regarding the fundamentals of oscilloscope probes, see this [white paper](#).

Table 1. NI offers several 400 and 500 MHz passive probes within its portfolio.



Single-Ended Passive Probes	SP500X	SP500C	CP500X	CP400X
Bandwidth (Hz)	500 MHz	500 MHz	500 MHz	400 MHz
Attenuation Ratio	10:1	100:1	10:1	10:1
Maximum Input Voltage (V)	±300 V	±300 V	±60 V	±60 V
Input Resistance	10 MΩ	100 MΩ	10 MΩ	10 MΩ
Input Capacitance	11 pF	4.6 pF	10 pF	13 pF
Capacitance Compensation Range	10-25 pF	10-25 pF	7-25 pF	10-40 pF
Rise Time	0.9 ns	0.9 ns	0.7 ns	0.9 ns
Oscilloscope Input Impedance	1 MΩ	1 MΩ	1 MΩ	1 MΩ
Connectors	BNC to Probe Tip	BNC to Probe Tip	BNC to BNC	BNC to BNC

Table 2. NI active probes range from 800 MHz to 2.5 GHz bandwidth.



Single-Ended and Differential Active Probes	SA1000X	SA1500X	SA2500X	NI 5191
Bandwidth	1000 MHz	1500 MHz	2500 MHz	800 MHz
Terminal Configuration	Single-Ended	Single-Ended	Single-Ended	Differential
Attenuation Ratio	10:1	10:1	10:1	10:1
Maximum Input Voltage	20 V	20 V	20 V	± 40 V (DC + Peak AC)
Common-Mode Input Voltage	±8 V	±8 V	±8 V	± 30 V (DC + Peak AC)
Differential Input Voltage	-	-	-	± 15 V (DC + Peak AC)
Input Resistance	1 MΩ	1 MΩ	1 MΩ	100 kΩ
Input Capacitance	0.9 pF	0.9 pF	0.9 pF	2 pF
Oscilloscope Input Impedance	50 Ω	50 Ω	50 Ω	50 Ω
Connector	BNC	BNC	BNC or SMA	BNC

Table 3. NI offers Hioki current probes that range from 5 A_{RMS} to 500 A measurements.



Current Probes ¹	CC0550X	CC05120X	CC3050X	CC30100X	CC15010X	CC5002X
Maximum Continuous Current	5 A _{RMS}	5 A _{RMS}	30 A _{RMS}	30 A _{RMS}	150 A	500 A
Output Voltage Rate (Volts per Amp)	1 V/A	1 V/A	0.1 V/A	0.1 V/A	0.01 V/A	0.01 V/A
Bandwidth (Hz)	50 MHz	120 MHz	50 MHz	100 MHz	10 MHz	2 MHz
Rise Time	7 ns	2.9 ns	7 ns	3.5 ns	35 ns	175 ns
Oscilloscope Input Impedance	1 MΩ	1 MΩ	1 MΩ	1 MΩ	1 MΩ	1 MΩ
Connector	BNC	BNC	BNC	BNC	BNC	BNC

¹ Require the use of the two-channel PS-OP01 power supply or PS-OP02 four-channel power supply



Figure 1. Hioki current probes require power supplies and also may need short cable adapters if using with SMA/SMB scopes or BNC scopes with closely adjacent channels.

PXI Oscilloscope + Probe Compatibility

Not all PXI Oscilloscopes can be used with all probes - a passive probe's 1 MΩ input capacitance range may not accommodate the 1 MΩ input capacitance of a certain oscilloscope, and current probes can only be used with oscilloscopes that have a 1 MΩ input. All of NI's oscilloscope probes have BNC connections, so PXI Oscilloscopes with SMA or SMB front panel connectors will require adapters, as noted in the table below.

Table 4. PXI Oscilloscopes range in their compatibility with passive, active, and current probes.

NI Oscilloscope	5105	5110	5111	5113	5114	5122	5124	5142	5145	5153	5164	5166	5168	5174	5177	5180	5181	5182	5 ³ 15	5 ³ 18	5922
Oscilloscope Connector	SMB	BNC	BNC	BNC	BNC	BNC	BNC	BNC	BNC	BNC	BNC	BNC	BNC	BNC	BNC	SMA	SMA	SMB	SMA / BNC	SMA / BNC	BNC
Single-Ended Passive Probes																					
SP500X	-	Y	Y	Y	-	-	-	-	Y	-	-	Y	Y	Y	Y	-	-	Y ¹	Y	Y	-
SP500C	-	Y	Y	Y	-	-	-	-	Y	-	-	Y	Y	Y	Y	-	-	Y ¹	Y	Y	-
CP500X	-	Y	Y	Y	-	-	-	-	Y	-	-	Y	Y	Y	Y	-	-	Y ¹	Y	Y	-
CP400X	-	Y	Y	Y	Y	Y	Y	Y	Y	-	-	Y	Y	Y	Y	-	-	Y ¹	Y	Y	-
Single-Ended and Differential Active Probes																					
SA1000X ⁴	Y ¹	Y	Y	Y	Y	Y	Y	Y	Y	Y	Y	Y	Y	Y	Y	Y ²	Y ²	Y ¹	Y	Y	Y
SA1500X ⁴	Y ¹	Y	Y	Y	Y	Y	Y	Y	Y	Y	Y	Y	Y	Y	Y	Y ²	Y ²	Y ¹	Y	Y	Y
SA2500X ⁴	Y ¹	Y	Y	Y	Y	Y	Y	Y	Y	Y	Y	Y	Y	Y	Y	Y ²	Y ²	Y ¹	Y	Y	Y
NI 5191	Y ¹	Y	Y	Y	Y	Y	Y	Y	Y	Y	Y	Y	Y	Y	Y	Y ²	Y ²	Y ¹	Y	Y	Y
Current Probes ⁴																					
CC0550X	Y ¹	Y	Y	Y	Y	Y	Y	Y	Y	-	-	Y	Y	Y	Y	-	-	Y ¹	Y	Y	Y
CC05120X	Y ¹	Y	Y	Y	Y	Y	Y	Y	Y	-	-	Y	Y	Y	Y	-	-	Y ¹	Y	Y	Y
CC3050X	Y ¹	Y	Y	Y	Y	Y	Y	Y	Y	-	-	Y	Y	Y	Y	-	-	Y ¹	Y	Y	Y
CC30100X	Y ¹	Y	Y	Y	Y	Y	Y	Y	Y	-	-	Y	Y	Y	Y	-	-	Y ¹	Y	Y	Y
CC15010X	Y ¹	Y	Y	Y	Y	Y	Y	Y	Y	-	-	Y	Y	Y	Y	-	-	Y ¹	Y	Y	Y
CC5002X	Y ¹	Y	Y	Y	Y	Y	Y	Y	Y	-	-	Y	Y	Y	Y	-	-	Y ¹	Y	Y	Y

¹ Requires SMB to BNC adapter

² Requires SMA to BNC adapter

³ PXIe-5185 and PXIe-5186: 50 Ω connector is SMA, 1 MΩ connector is BNC

⁴ The use of some active or current probes on adjacent BNC oscilloscope channels may require the use of short BNC to BNC adapter due to proximity.

8-Bit PXI Oscilloscopes

PXIe-5110, PXIe-5111, PXIe-5113, PXIe-5185, and PXI-5186



- **Software:** Includes InstrumentStudio™ support for interactive measurements, API support for LabVIEW and text-based languages, shipping examples, and detailed help files
- Two analog channels
- 100 MHz – 5 GHz analog bandwidth
- Edge, digital, immediate, and software standard triggers
- Additional window, hysteresis, glitch, runt, and width triggers on PXIe-5110, 5111 and 5113

Optimized for Cost or Speed

NI's 8-bit PXI Oscilloscopes range from the lowest cost 100 MHz PXIe-5110 model to the widest bandwidth 5 GHz PXIe-5186 model. They provide the measurement performance of traditional box oscilloscopes in a form factor better suited for automated test and high-channel-count applications. Programmable settings for coupling, input impedance, voltage range, and filtering offer flexibility for automated and partially automated applications. Combined with the high throughput and low latency of the PCI Express bus, they are better equipped than LAN and GPIB alternatives to sequence measurements quickly and keep test time to a minimum. The PXI backplane also allows you to easily synchronize PXI Oscilloscopes either with each other or additional instrument types for mixed-signal tests.

Table 5. NI's 8-bit oscilloscopes range from 100 MHz to 5 GHz options.

	PXIe-5110	PXIe-5111	PXIe-5113	PXIe-5185	PXIe-5186
50 Ω Bandwidth	100 MHz	350 MHz	500 MHz	3 GHz	5 GHz
1 MΩ Bandwidth	100 MHz	350 MHz	500 MHz	500 MHz	500 MHz
ADC Resolution	8-bit	8-bit	8-bit	8-bit	8-bit
Channels	2	2	2	2	2
Maximum Sample Rate	1 GS/s Divide by number of channels used	3 GS/s Divide by number of channels used	3 GS/s Divide by number of channels used	12.5 GS/s Divide by number of channels used	12.5 GS/s Divide by number of channels used
50 Ω Full Scale Input Voltage Range	0.04 to 10 V _{pk-pk}	0.04 to 10 V _{pk-pk}	0.04 to 10 V _{pk-pk}	0.11 to 1 V _{pk-pk}	0.11 to 1 V _{pk-pk}
50 Ω Maximum Voltage Offset (Depends on Input Range)	± 5 V	± 5 V	± 5 V	± 0.25 V	± 0.25 V
1 MΩ Full Scale Input Voltage Range	0.04 to 40 V _{pk-pk}	0.04 to 40 V _{pk-pk}	0.04 to 40 V _{pk-pk}	0.11 to 10 V _{pk-pk}	0.11 to 10 V _{pk-pk}
1 MΩ Maximum Voltage Offset (Depends on Input Range)	± 100 V	± 100 V	± 100 V	± 2.5 V	± 2.5 V
Input Channel Connector	BNC	BNC	BNC	SMA (50 Ω) BNC (1 MΩ)	SMA (50 Ω) BNC (1 MΩ)
Input Capacitance (Characteristic)	16 pF	15.4 pF	15.4 pF	10 pF	10pF
User-Programmable FPGA	N/A	N/A	N/A	N/A	N/A
Maximum External Calibration Cycle	2 Years	2 Years	2 Years	1 Year	1 Year

Detailed View of PXIe-5113 Oscilloscope

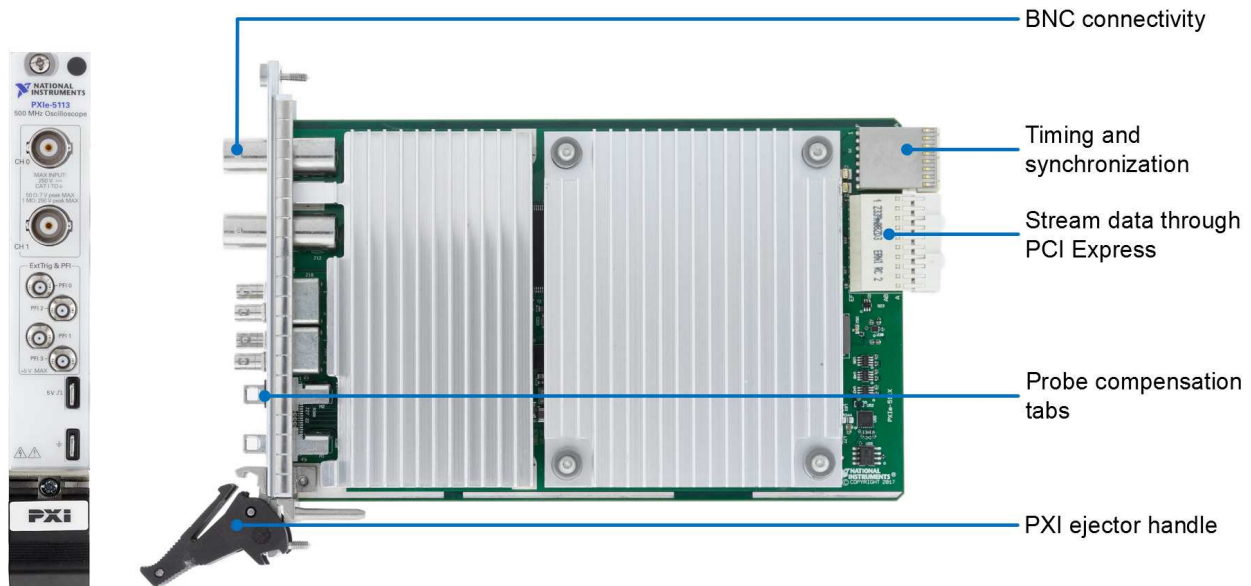

10-Bit and 12-Bit PXI Oscilloscopes

PXIe-5105, PXIe-5160, and PXIe-5162



- **Software:** Includes InstrumentStudio support for interactive measurements, API support for LabVIEW and text-based languages, shipping examples, and detailed help files
- Two, four, and eight analog channel options
- 60 MHz – 1.5 GHz analog bandwidth
- Edge, hysteresis, digital, immediate, and software standard triggers
- Additional window trigger on PXIe-5105

Optimized for Speed, Resolution, and Density

NI's 10-bit and 12-bit PXI Oscilloscopes optimize the opposing specifications of sample rate, ADC resolution, and channel density into high-performing, general-purpose products. They provide the measurement performance of traditional box oscilloscopes in a form factor better suited for automated test and high-channel-count applications. Programmable settings for coupling, input impedance, voltage range, and filtering offer flexibility for automated and partially automated applications. Combined with the high throughput and low latency of the PCI Express bus, they are better equipped than LAN and GPIB alternatives to sequence measurements quickly and keep test time to a minimum. The PXI backplane also allows you to easily synchronize PXI Oscilloscopes either with each other or additional instrument types for mixed-signal tests.

Table 6. NI's 10- and 12-bit oscilloscopes range from 60 MHz to 1.5 GHz options.

	PXIe-5105	PXIe-5160	PXIe-5162
50 Ω Bandwidth	60 MHz	500 MHz	1.5 GHz
1 M Ω Bandwidth	60 MHz	300 MHz	300 MHz
ADC Resolution	12-bit	10-bit	10-bit
Channels	8	2 or 4	2 or 4
Maximum Sample Rate	60 MS/s Independent sampling channels	2.5 GS/s (1-ch or 2-ch) 1.25 GS/s (4-ch)	5 GS/s Divide by number of channels used
50 Ω Full Scale Input Voltage Range	0.05 to 6 V _{pk-pk}	0.05 to 5 V _{pk-pk}	0.05 to 5 V _{pk-pk}
50 Ω Maximum Voltage Offset (Depends on Input Range)	N/A	± 1.5 V	± 1.5 V
1 M Ω Full Scale Input Voltage Range	0.05 to 30 V _{pk-pk}	0.05 to 50 V _{pk-pk}	0.05 to 50 V _{pk-pk}
1 M Ω Maximum Voltage Offset (Depends on Input Range)	N/A	± 30 V	± 30 V
Input Channel Connector	SMB	BNC	BNC
Input Capacitance (Characteristic)	29 pF	15 pF	15 pF
User-Programmable FPGA	N/A	N/A	N/A
Maximum External Calibration Cycle	2 Years	2 Years	2 Years

Detailed View of PXIe-5162 Oscilloscope



14-Bit PXI Oscilloscopes

PXIe-5122, PXIe-5163, PXIe-5164, PXIe-5170, PXIe-5171, and PXIe-5172



- **Software:** Includes InstrumentStudio support for interactive measurements, API support for LabVIEW and text-based languages, shipping examples, and detailed help files
- Two, four, and eight analog channel options
- 100 MHz – 400 MHz analog bandwidth
- Edge, window, hysteresis, digital, immediate, and software standard triggers
- Additional video trigger on PXIe-5122
- User-programmable Xilinx Kintex-7 FPGA on PXIe-5164, 5170, 5171, and 5172

Optimized for Resolution and Density

NI's 14-bit PXI Oscilloscopes are optimized for high ADC resolution and often, high channel density as well. They provide the measurement performance of traditional box oscilloscopes in a form factor better suited for automated test and high-channel-count applications. Programmable settings for coupling, input impedance, voltage range, and filtering offer flexibility for automated and partially automated applications. Combined with the high throughput and low latency of the PCI Express bus, they are better equipped than LAN and GPIB alternatives to sequence measurements quickly and keep test time to a minimum. The PXI backplane also allows you to easily synchronize PXI Oscilloscopes either with each other or additional instrument types for mixed-signal tests. Several 14-bit PXI Oscilloscopes also have a user-programmable Xilinx Kintex-7 FPGA for implementing custom triggers or intensive in-line processing.

Table 7. NI's 14-bit oscilloscopes range from 100 MHz to 400 MHz options.

	PXIe-5122	PXIe-5163	PXIe-5164	PXIe-5170	PXIe-5171	PXIe-5172
50 Ω Bandwidth	100 MHz	200 MHz	400 MHz	100 MHz	250 MHz	100 MHz
1 MΩ Bandwidth	100 MHz	200 MHz	300 MHz	N/A	N/A	100 MHz
ADC Resolution	14-bit	14-bit	14-bit	14-bit	14-bit	14-bit
Channels	2	2	2	4 or 8	8	8
Maximum Sample Rate	100 MS/s Independent sampling channels	1 GS/s Independent sampling channels	1 GS/s Independent sampling channels	250 MS/s Independent sampling channels	250 MS/s Independent sampling channels	250 MS/s Independent sampling channels
50 Ω Full Scale Input Voltage Range	0.2 to 10 V _{pk-pk}	0.25 to 5 V _{pk-pk}	0.25 to 5 V _{pk-pk}	0.2 to 5 V _{pk-pk}	0.2 to 5 V _{pk-pk}	0.2 to 10 V _{pk-pk}
50 Ω Maximum Voltage Offset (Depends on Input Range)	± 2 V	N/A	N/A	N/A	N/A	± 2.5 V
1 MΩ Full Scale Input Voltage Range	0.2 to 20 V _{pk-pk}	0.25 to 100 V _{pk-pk}	0.25 to 100 V _{pk-pk}	N/A	N/A	0.2 to 80 V _{pk-pk}
1 MΩ Maximum Voltage Offset (Depends on Input Range)	± 5 V	± 248.75 V	± 248.75 V	N/A	N/A	± 20 V
Input Channel Connector	BNC	BNC	BNC	SMA	SMA	SMB
Input Capacitance (Characteristic)	29 pF	20.2 pF	20.2 pF	N/A	N/A	16 pF
User-Programmable FPGA	N/A	N/A	Xilinx Kintex-7 410T	Xilinx Kintex-7 325T	Xilinx Kintex-7 410T	Xilinx Kintex-7 325T or 410T
Maximum External Calibration Cycle	2 Years	2 Years	2 Years	2 Years	2 Years	2 Years

Detailed View of PXIe-5171 Oscilloscope

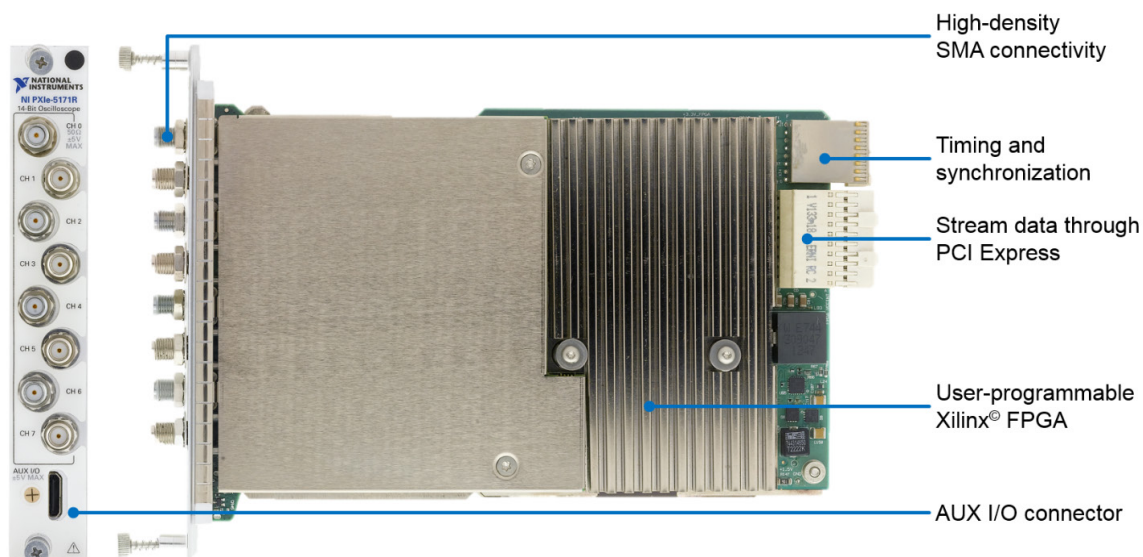

PXIe-517x Series Highlight – Key Features

High-Density, High-Performance, Simultaneously-Sampled Channels

To enable their compact, flexible, and powerful design, PXIe-517x oscilloscopes take advantage of multiple technological advances, including low-power, high-resolution ADCs that use JESD204B high-speed serial interface for data transfer and high-performance, low-power Xilinx Kintex-7 FPGAs.

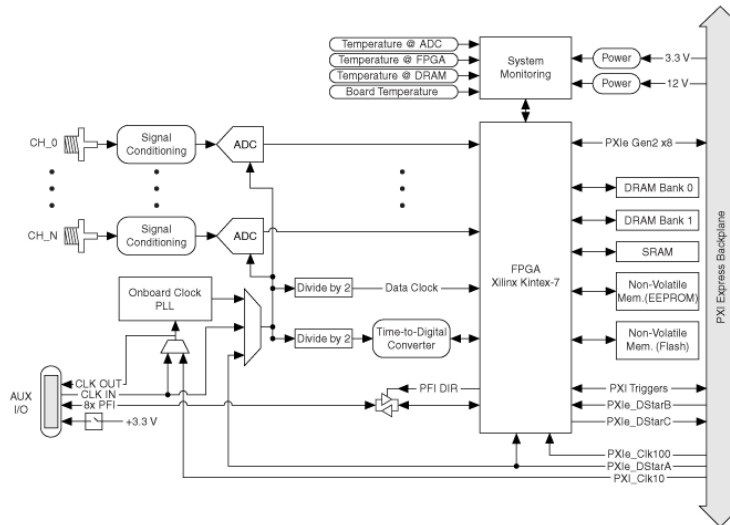

Figure 1. The PXIe-517x oscilloscopes are built around a 14-bit, Analog Devices ADC and a Xilinx Kintex-7 FPGA.

The First Oscilloscopes With LabVIEW-Programmable FPGAs

The first oscilloscopes to include FPGAs that could be targeted and reprogrammed with the LabVIEW FPGA Module were the PXIe-517x series. With this leap forward in instrumentation technology, you can define the operation of your oscilloscopes to meet your needs now and in the future as your devices and experiments change. PXIe-517x oscilloscopes give you excellent channel density, accuracy, and measurement flexibility along with a user-programmable FPGA for implementing custom triggers or in-line processing. Futureproof your test equipment and improve your test yield with the PXIe-517x reconfigurable oscilloscopes.

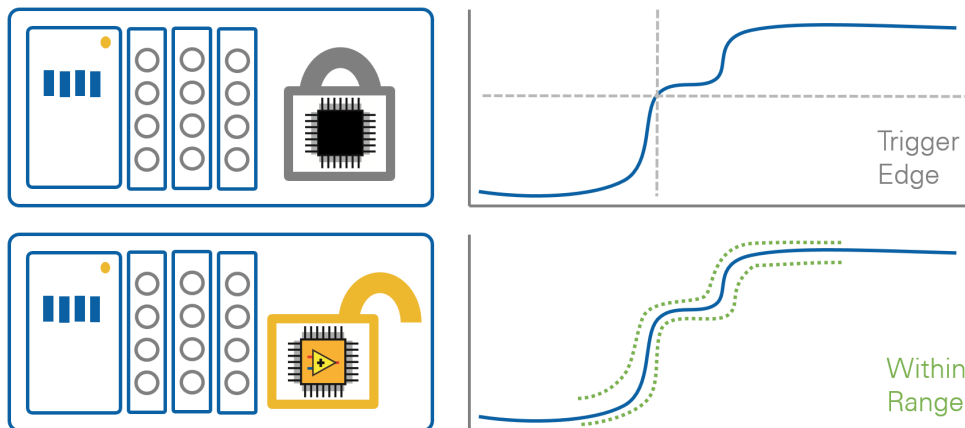

Figure 2. A user-programmable FPGA allows you to customize the firmware of an oscilloscope to achieve the results required.

PXIe-5164 Highlight – Portfolio Leader

Wide Dynamic Range ADC and Front End

The PXIe-5164 departs from the usual oscilloscope circuit arrangement to achieve a low noise floor and high measurement accuracy. Figure 2 shows the difference in the block diagrams of typical oscilloscopes, in which the 50 Ω mode is accomplished by simply connecting a 50 Ω resistor in parallel with the front panel input, and the approach taken in the PXIe-5164 oscilloscope, in which a dedicated 50 Ω path bypasses the 1 MΩ section and connects directly to the low-impedance amplifier section. Using one amplifier rather than several eliminates the noise and distortion contributions of the multiple stages.

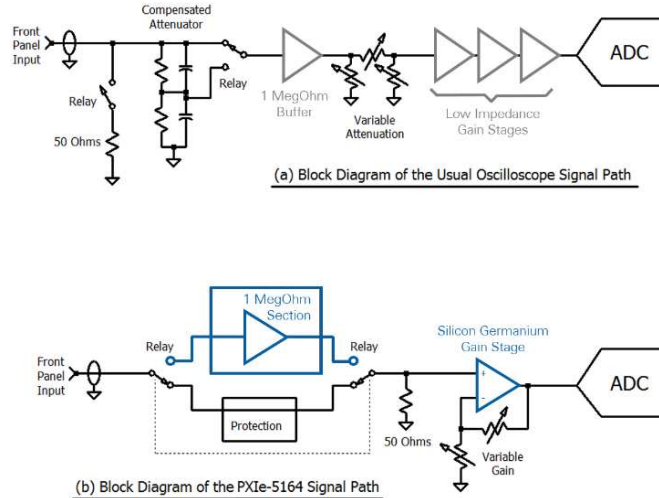

Figure 4. The PXIe-5164 oscilloscope has a signal path (b) optimized for measurement accuracy by bypassing the 1 MΩ buffer on the 50 Ω path and having only a single gain stage, as opposed to a usual oscilloscope signal path (a) that is optimized for high impedance and voltage.

A time domain plot of a one-time-event communications signal riding on a digital pulse taken with a box scope and a PXIe-5164 oscilloscope clearly illustrates the superior dynamic range of the PXIe-5164 over a popular 8-bit box oscilloscope. The communications signal is nearly indiscernible in the data captured with the 8-bit box scope but easily recognizable and decodable in the data captured by the PXIe-5164 oscilloscope.

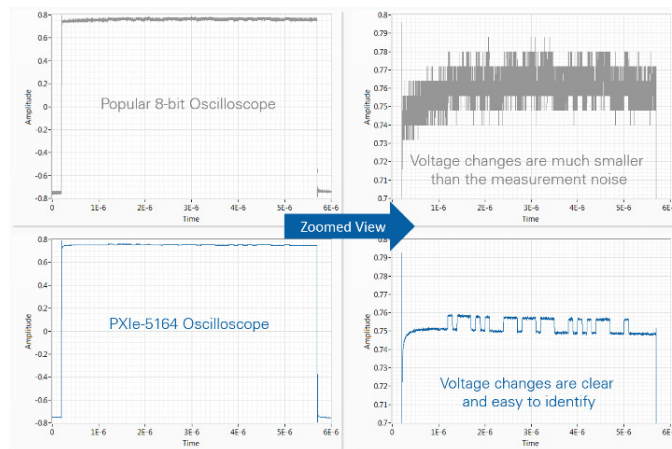

Figure 5. Compare the time domain plots of a popular 8-bit box oscilloscope with the PXIe-5164 oscilloscope with both sampling an identical one-time-event communications signal riding on a digital pulse. The communications signal is nearly indiscernible on the 8-bit box scope but easily recognized and decodable on the PXIe-5164.

The superior dynamic range of the PXIe-5164 is even more pronounced in the frequency domain. The noise floor of the PXIe-5164 oscilloscope is a significant 22 dB lower than that of the popular 8-bit oscilloscope. The PXIe-5164 oscilloscope also has the better harmonic distortion performance.

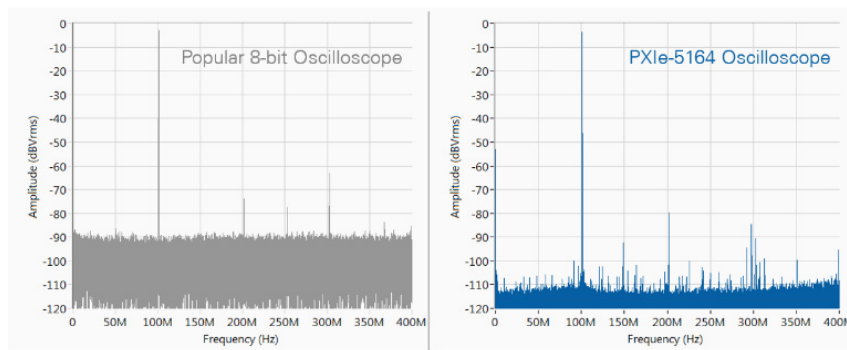

Figure 6. By comparing the spectral results of a popular 8-bit box oscilloscope with the PXIe-5164 oscilloscope, you can see the noise floor of the PXIe-5164 oscilloscope is a significant 22 dB lower.

DSP Stabilizes and Equalizes the Magnitude and Phase Responses

Digital filtering can offer a considerable improvement in range-to-range, channel-to-channel, and even unit-to-unit variability in the frequency and step response of an oscilloscope’s analog front end. The PXIe-5164 oscilloscope has a 16-tap finite impulse response (FIR) filter in the FPGA and in line with the ADC data stream to realize a very flat frequency response of ± 0.35 dB up to 330 MHz. Below is a typical PXIe-5164 oscilloscope response in which the deviation from 0 dB is less than 0.022 dB for all ranges and channels and a measured step response in which the symmetry in the waveform indicates the desired linear phase characteristic.

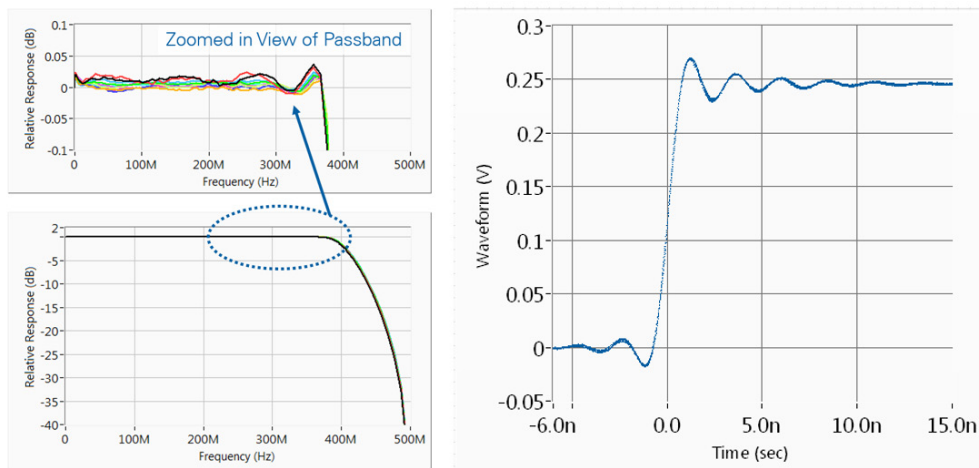

Figure 7. This graph shows the frequency and step response of a typical PXIe-5164 oscilloscope on the 50 Ohm path up to the full bandwidth. The response of all ranges and channels of one module are superimposed and the maximum deviation in the passband is 0.022.

24-Bit PXI Oscilloscope

PXI-5922



- **Software:** Includes InstrumentStudio support for interactive measurements, API support for LabVIEW and text-based languages, shipping examples, and detailed help files
- Up to -114 dBc SFDR and noise floor of -120 dBFS
- Two simultaneously sampled channels with 24-bit resolution up to 500 kS/s and 16-bit resolution up to 15 MS/s
- Integrated anti-alias protection for all sampling rates
- Edge, window, hysteresis, digital, immediate, and software standard triggers

Flexible Resolution

The PXI-5922 is one of the most sensitive analog signal measurement instruments on the market, with 24 bits of effective measurement resolution, up to -114 dBc SFDR, and a noise floor as low as -120 dBFS. In general, PXI Oscilloscopes provide the measurement performance of traditional box oscilloscopes in a form factor better suited for automated test and high-channel-count applications. Programmable settings for coupling, input impedance, voltage range, and filtering offer flexibility for automated and partially automated applications. Combined with the high throughput and low latency of the PCI Express bus, they are better equipped than LAN and GPIB alternatives to sequence measurements quickly and keep test time to a minimum. The PXI backplane also allows you to easily synchronize PXI Oscilloscopes either with each other or additional instrument types for mixed-signal tests.

Table 8. The PXI-5922 establishes a tradeoff between effective measurement resolution and available sample rates.

	PXI-5922												
50 Ω Bandwidth	6 MHz												
1 MΩ Bandwidth	6 MHz												
Resolution (bits) by Sample Rate	<table border="1"> <tr> <td>50 kS/s</td> <td>24-bit</td> </tr> <tr> <td>500 kS/s</td> <td>24-bit</td> </tr> <tr> <td>1 MS/s</td> <td>22-bit</td> </tr> <tr> <td>5 MS/s</td> <td>20-bit</td> </tr> <tr> <td>10 MS/s</td> <td>18-bit</td> </tr> <tr> <td>15 MS/s</td> <td>16-bit</td> </tr> </table>	50 kS/s	24-bit	500 kS/s	24-bit	1 MS/s	22-bit	5 MS/s	20-bit	10 MS/s	18-bit	15 MS/s	16-bit
50 kS/s	24-bit												
500 kS/s	24-bit												
1 MS/s	22-bit												
5 MS/s	20-bit												
10 MS/s	18-bit												
15 MS/s	16-bit												
Maximum Sample Rate (Independent Sampling Channels)	15 MS/s												
50 Ω Full Scale Input Voltage Range	2 to 10 V _{pk-pk}												
50 Ω Maximum Voltage Offset (Depends on Input Range)	N/A												
1 MΩ Full Scale Input Voltage Range	2 to 10 V _{pk-pk}												
1 MΩ Maximum Voltage Offset (Depends on Input Range)	N/A												
Input Channel Connector	BNC												
Input Capacitance (Characteristic)	60 pF												
User-Programmable FPGA	N/A												
Maximum External Calibration Cycle	2 Years												

Detailed View of PXI-5922 Oscilloscope

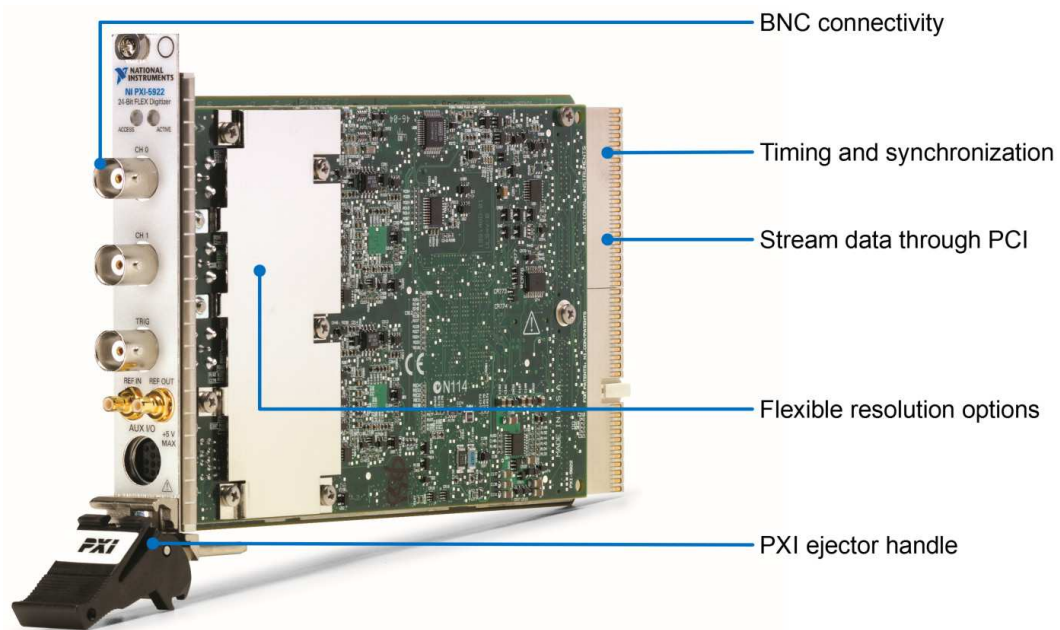

Flex II ADC: Flexible Resolution Technology Highlight

The PXI-5922 is a **flexible resolution** oscilloscope that can be used to acquire data at different sampling rates to achieve variable resolutions depending on the need of the application. For example, at sampling rates up to 500 kS/s the PXI-5922 delivers 24-bit resolution. This same module, without any changes, can trade resolution for sampling speed and sample at 15 MS/s with 16-bit resolution.

With its flexible resolution and high dynamic range, the PXI-5922 is the first universal instrument for dynamic measurements. Just as the digital multimeter (DMM) is used as a universal measurement device for DC measurements like voltage, current, and resistance, the PXI-5922 revolutionizes AC measurements, combining the measurement capabilities of many instruments into one. With unmatched performance over a range of sampling rates up to 15 MS/s, this oscilloscope combined with powerful LabVIEW software can be used to replace the measurement capabilities of many traditional instruments such as audio analyzers, spectrum analyzers, IF oscilloscopes, DC and rms voltmeters, and frequency counters.

Many applications including audio, communications, and ultrasound demand extremely high dynamic performance. While traditional instrumentation has made incremental performance improvements, it has not been able to keep pace with the resolution and dynamic range requirements. On the other hand, the PXI-5922 introduces an unprecedented expansion in dynamic range and resolution.

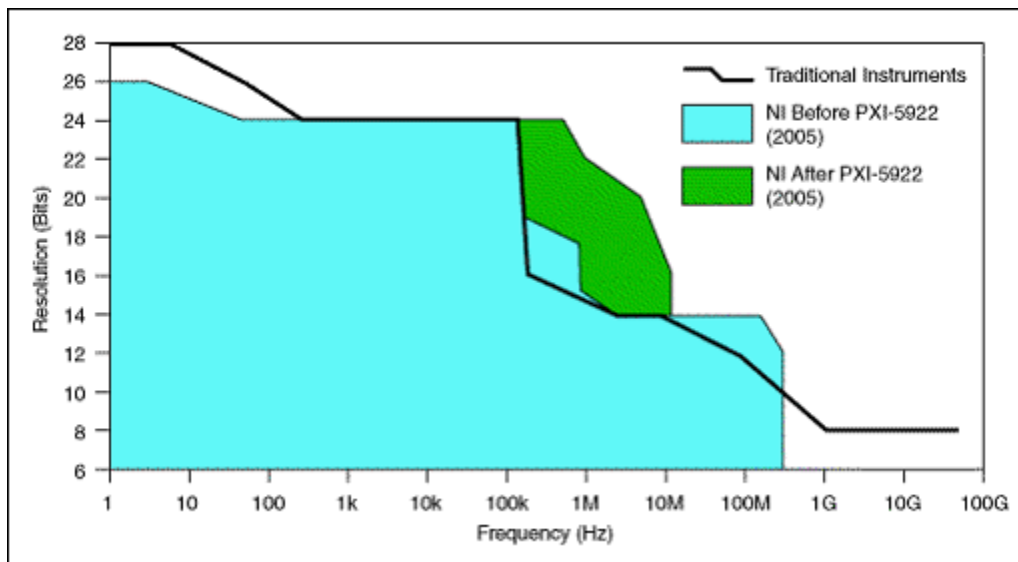

Figure 8. This graph plots the frequency (speed at which the signal is digitized) versus the resolution (accuracy with which the signal is acquired) of traditional instrumentation versus NI data acquisition and modular instrumentation devices.

Features Common to All PXI Oscilloscopes

In general, PXI Oscilloscopes provide the measurement performance of traditional box oscilloscopes in a form factor better suited for automated test and high-channel-count applications. Various advantages include integration with other instrument types, synchronization for high-channel-count systems, superior data throughput and lower bus latency, deep onboard memory, and debug monitoring and control support in InstrumentStudio software.

Synchronization and Integration

NI oscilloscopes use the inherent timing and synchronization capabilities of the PXI platform to communicate with switches and other instruments within the PXI chassis. Using the timing features of the PXI chassis and additional timing software, you can achieve synchronization of <10 ps between channels of multiple oscilloscopes. NI oscilloscopes can also “handshake” with NI waveform generators by sending and receiving hardware-timed triggers over the PXI backplane, scanning through a list of frequencies in a scan list stored in memory onboard the waveform generator. This method of scanning removes the software overhead associated with traditional scan lists and can create a deterministic scan list for faster test execution with more repeatable timing.

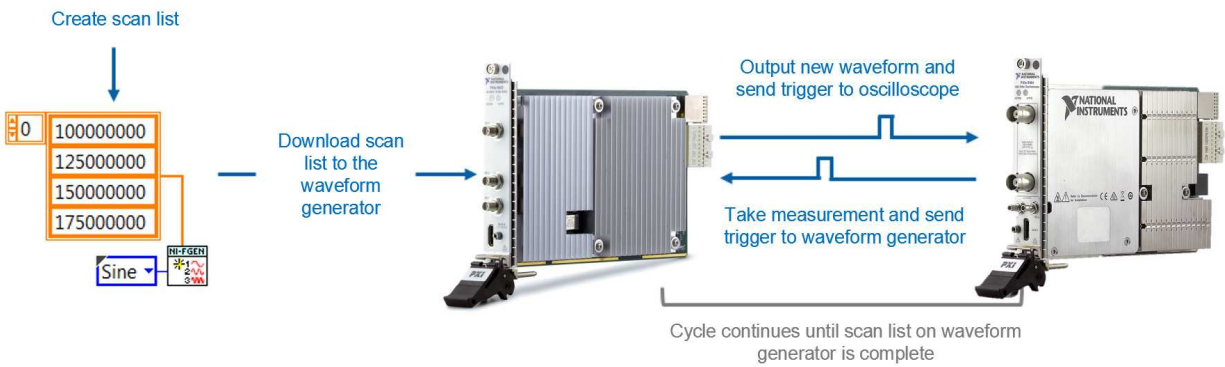

Self-Calibration and Two-Year Guaranteed Specifications

NI oscilloscopes offer self-calibration, which is a unique feature that corrects for all DC gain and offset drifts within the instrument using a precision, high-stability internal voltage. Using the self-calibration feature makes NI oscilloscopes highly accurate and stable at any operating temperature—well outside the traditional 18 °C to 28 °C range.

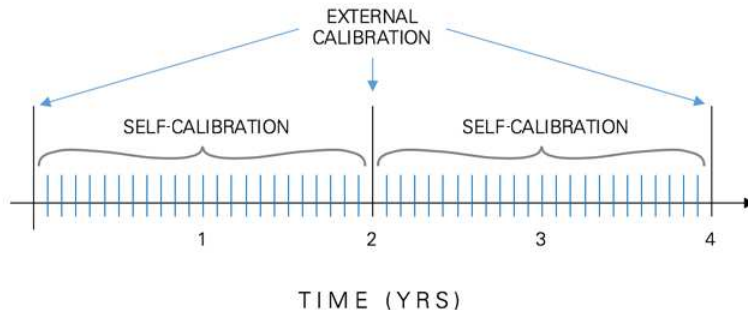

Performing self-calibration takes only a few minutes to complete and requires no external calibrator, minimizing the maintenance burden of deployed systems. Most NI oscilloscopes have up to a two-year external calibration cycle thanks to the self-calibration precision circuitry that minimizes the maintenance burden of deployed systems. Note that the PXIe-5185 and 5186 specifically maintain a one-year calibration interval. Visit ni.com to learn more about [NI's calibration services](#).

InstrumentStudio Software for Interactive Measurements

InstrumentStudio helps you to unify your display, export instrument configurations to code, and monitor and debug your automated test system. You can view data on unified displays with large, high-resolution monitors, and then capture multi-instrument screenshots and measurement results. Save project-level configurations for easier test repeatability with specific devices under test, or export instrument configurations to programming environments to simplify your code and guarantee measurement correlation. You can also use InstrumentStudio in parallel with your code to monitor and debug running test applications. InstrumentStudio is free software included with NI-SCOPE, NI-FGEN, NI-DMM, and NI-DCPower driver downloads 18.1 and later.

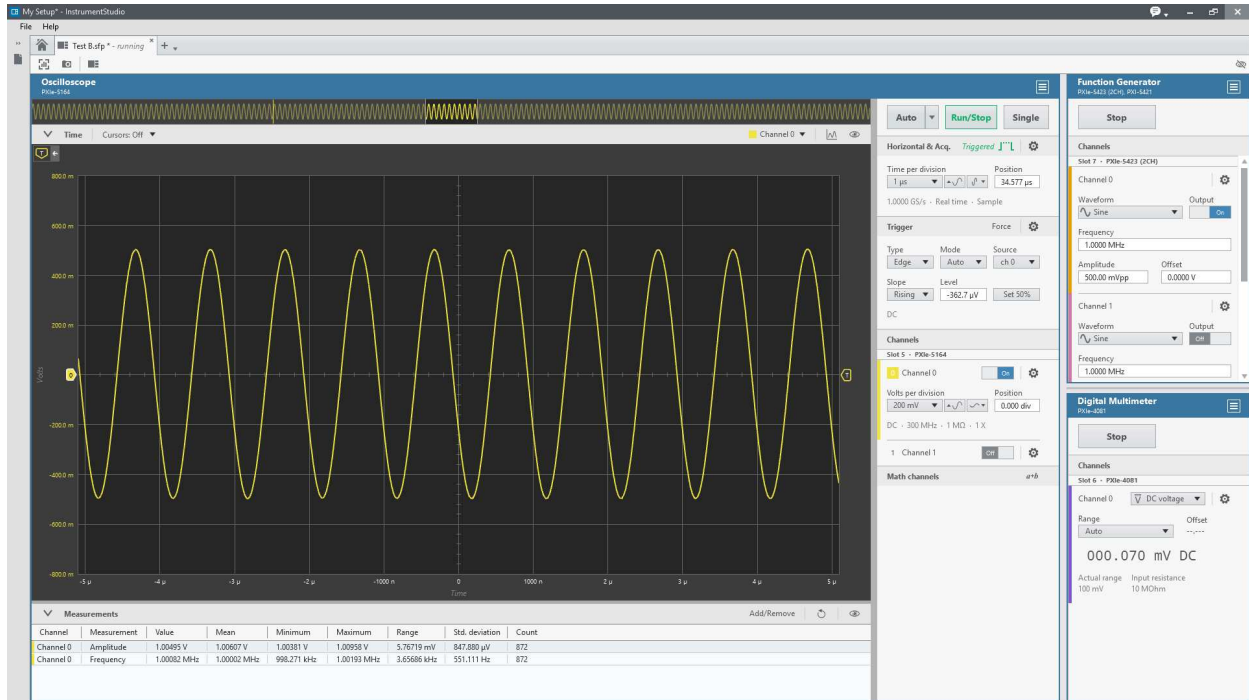

NI-SCOPE Application Programming Interface (API)

In addition to the InstrumentStudio soft front panel, the NI-SCOPE driver includes a best-in-class API that works with a variety of development options such as LabVIEW, C, C#, Python, and others. To ensure long-term interoperability of oscilloscopes, the NI-SCOPE driver API is the same API used for all past and current NI oscilloscopes. The driver also provides access to help files, documentation, and dozens of ready-to-run shipping examples you can use as a starting point for your application.

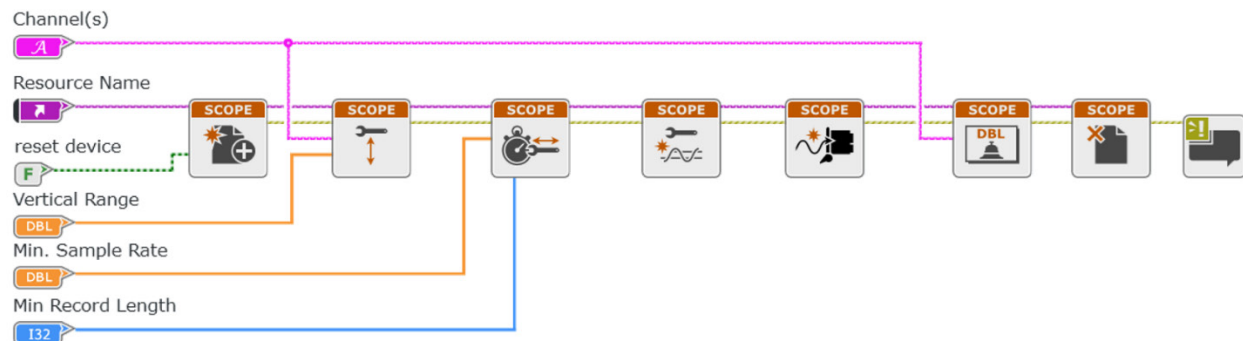

Platform-Based Approach to Test and Measurement



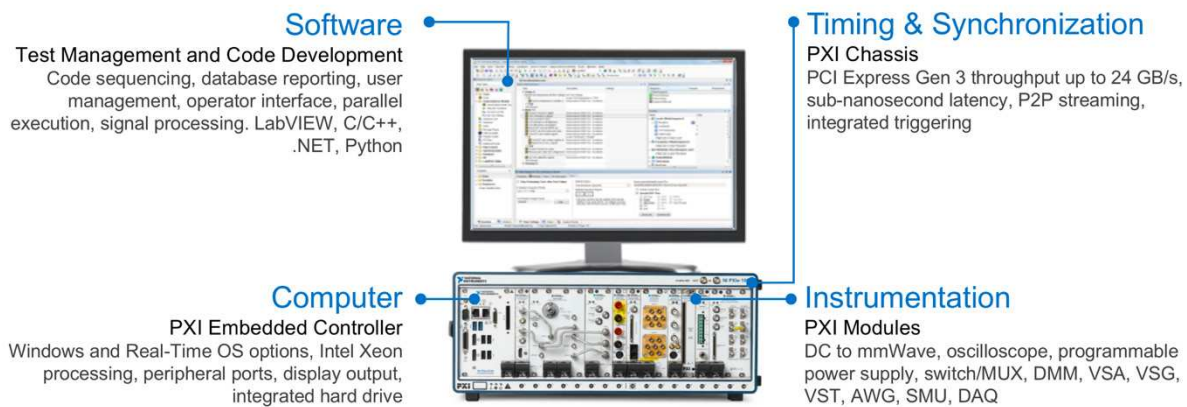

What Is PXI?

Powered by software, PXI is a rugged PC-based platform for measurement and automation systems. PXI combines PCI electrical-bus features with the modular, Eurocard packaging of CompactPCI and then adds specialized synchronization buses and key software features. PXI is both a high-performance and low-cost deployment platform for applications such as manufacturing test, military and aerospace, machine monitoring, automotive, and industrial test. Developed in 1997 and launched in 1998, PXI is an open industry standard governed by the PXI Systems Alliance (PXISA), a group of more than 70 companies chartered to promote the PXI standard, ensure interoperability, and maintain the PXI specification.



Integrating the Latest Commercial Technology

By leveraging the latest commercial technology for our products, we can continually deliver high-performance and high-quality products to our users at a competitive price. The latest PCI Express Gen 3 switches deliver higher data throughput, the latest Intel multicore processors facilitate faster and more efficient parallel (multisite) testing, the latest FPGAs from Xilinx help to push signal processing algorithms to the edge to accelerate measurements, and the latest data converters from TI and ADI continually increase the measurement range and performance of our instrumentation.

<p>HIGHER DATA THROUGHPUT</p>  <p>PCI Express Gen 3</p>	<p>PARALLEL TEST EXECUTION</p>  <p>Multicore Processors</p>	<p>MEASUREMENT ACCELERATION</p>  <p>FPGAs</p>	<p>INCREASED MEASUREMENT RANGE</p>  <p>Data Converters</p>
--	--	---	---

PXI Instrumentation

NI offers more than 600 different PXI modules ranging from DC to mmWave. Because PXI is an open industry standard, nearly 1,500 products are available from more than 70 different instrument vendors. With standard processing and control functions designated to a controller, PXI instruments need to contain only the actual instrumentation circuitry, which provides effective performance in a small footprint. Combined with a chassis and controller, PXI systems feature high-throughput data movement using PCI Express bus interfaces and sub-nanosecond synchronization with integrated timing and triggering.



Oscilloscopes

Sample at speeds up to 12.5 GS/s with 5 GHz of analog bandwidth, featuring numerous triggering modes and deep onboard memory



Digital Multimeters

Perform voltage (up to 1000 V), current (up to 3A), resistance, inductance, capacitance, and frequency/period measurements, as well as diode tests



Digital Instruments

Perform characterization and production test of semiconductor devices with timing sets and per channel pin parametric measurement unit (PPMU)



Waveform Generators

Generate standard functions including sine, square, triangle, and ramp as well as user-defined, arbitrary waveforms



Frequency Counters

Perform counter timer tasks such as event counting and encoder position, period, pulse, and frequency measurements



Source Measure Units

Combine high-precision source and measure capability with high channel density, deterministic hardware sequencing, and SourceAdapt transient optimization



Power Supplies & Loads

Supply programmable DC power, with some modules including isolated channels, output disconnect functionality, and remote sense



FlexRIO Custom Instruments & Processing

Provide high-performance I/O and powerful FPGAs for applications that require more than standard instruments can offer



Switches (Matrix & MUX)

Feature a variety of relay types and row/column configurations to simplify wiring in automated test systems



Vector Signal Transceivers

Combine a vector signal generator and vector signal analyzer with FPGA-based, real-time signal processing and control



GPIB, Serial, & Ethernet

Integrate non-PXI instruments into a PXI system through various instrument control interfaces



Data Acquisition Modules

Provide a mix of analog I/O, digital I/O, counter/timer, and trigger functionality for measuring electrical or physical phenomena

Hardware Services

All NI hardware includes a one-year warranty for basic repair coverage, and calibration in adherence to NI specifications prior to shipment. PXI systems also include basic assembly and a functional test. NI offers additional entitlements to improve uptime and lower maintenance costs with service programs for hardware. Learn more at ni.com/services/hardware.

	Standard	Premium	Description
Program Duration	1, 3, or 5 years	1, 3, or 5 years	Length of service program
Extended Repair Coverage	•	•	NI restores your device's functionality and includes firmware updates and factory calibration.
System Configuration, Assembly, and Test ¹	•	•	NI technicians assemble, install software in, and test your system per your custom configuration prior to shipment.
Advanced Replacement ²		•	NI stocks replacement hardware that can be shipped immediately if a repair is needed.
System Return Material Authorization (RMA) ¹		•	NI accepts the delivery of fully assembled systems when performing repair services.
Calibration Plan (Optional)	Standard	Expedited ³	NI performs the requested level of calibration at the specified calibration interval for the duration of the service program.

¹This option is only available for PXI, CompactRIO, and CompactDAQ systems.

²This option is not available for all products in all countries. Contact your local NI sales engineer to confirm availability.

³Expedited calibration only includes traceable levels.

PremiumPlus Service Program

NI can customize the offerings listed above, or offer additional entitlements such as on-site calibration, custom sparing, and life-cycle services through a PremiumPlus Service Program. Contact your NI sales representative to learn more.

Technical Support

Every NI system includes a 30-day trial for phone and e-mail support from NI engineers, which can be extended through a [Software Service Program \(SSP\)](#) membership. NI has more than 400 support engineers available around the globe to provide local support in more than 30 languages. Additionally, take advantage of NI's award winning [online resources](#) and [communities](#).

©2019 National Instruments. All rights reserved. LabVIEW, National Instruments, NI, NI TestStand, and ni.com are trademarks of National Instruments. Other product and company names listed are trademarks or trade names of their respective companies. The contents of this Site could contain technical inaccuracies, typographical errors or out-of-date information. Information may be updated or changed at any time, without notice. Visit ni.com/manuals for the latest information.

10 December 2019