

COMPREHENSIVE SERVICES

We offer competitive repair and calibration services, as well as easily accessible documentation and free downloadable resources.

SELL YOUR SURPLUS

We buy new, used, decommissioned, and surplus parts from every NI series. We work out the best solution to suit your individual needs.

 Sell For Cash  Get Credit  Receive a Trade-In Deal

OBSOLETE NI HARDWARE IN STOCK & READY TO SHIP

We stock **New**, **New Surplus**, **Refurbished**, and **Reconditioned** NI Hardware.



Bridging the gap between the manufacturer and your legacy test system.

 1-800-915-6216

 www.apexwaves.com

 sales@apexwaves.com

All trademarks, brands, and brand names are the property of their respective owners.

Request a Quote

 **CLICK HERE**

FP-TB-1

FP-TC-120 AND cFP-TC-120

8-Channel Thermocouple Input Modules

These operating instructions describe how to install and use the National Instruments FP-TC-120 and cFP-TC-120 thermocouple input modules (referred to inclusively as the [c]FP-TC-120). For details on configuring and accessing the [c]FP-TC-120 over a network, refer to the user manual for the FieldPoint network module you are using.

Features

The [c]FP-TC-120 is a FieldPoint thermocouple input module with the following features:

- Eight thermocouple or millivolt inputs
- Built-in linearization and cold-junction compensation for eight thermocouple types: J, K, R, S, T, N, E, and B
- Four voltage ranges: ± 25 , ± 50 , ± 100 , and -20 to 80 mV
- Open-thermocouple detection and indicator LEDs
- 16-bit resolution
- Differential inputs
- Filtering against 50 and 60 Hz noise
- $2,300 V_{\text{rms}}$ transient overvoltage protection between the inter-module communication bus and the I/O channels
- $250 V_{\text{rms}}$ isolation voltage rating
- -40 to 70 °C operation
- Hot plug-and-play

FieldPoint™, National Instruments™, NI™, and ni.com™ are trademarks of National Instruments Corporation. Product and company names mentioned herein are trademarks or trade names of their respective companies. For patents covering National Instruments products, refer to the appropriate location: **Help»Patents** in your software, the `patents.txt` file on your CD, or `ni.com/patents`.

Installing the FP-TC-120

The FP-TC-120 mounts on a FieldPoint terminal base (FP-TB-*x*). Hot plug-and-play enables you to install the FP-TC-120 onto a powered terminal base without disturbing the operation of other modules or terminal bases. The FP-TC-120 receives operating power from the terminal base.

To install the FP-TC-120, refer to Figure 1 and follow these steps:

1. Slide the terminal base key to either position X (for any module) or position 1 (for the FP-TC-120).
2. Align the FP-TC-120 alignment slots with the guide rails on the terminal base.
3. Press firmly to seat the FP-TC-120 on the terminal base. The latch on the terminal base locks the FP-TC-120 into place when it is firmly seated.

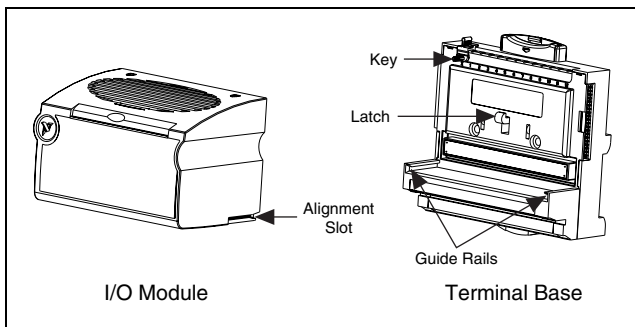

Figure 1. Installing the FP-TC-120

Installing the cFP-TC-120

The cFP-TC-120 mounts on a FieldPoint backplane (cFP-BP-*x*). Hot plug-and-play enables you to install the cFP-TC-120 onto a powered backplane without disturbing the operation of other modules or connector blocks. The cFP-TC-120 receives operating power from the backplane.

To install the cFP-TC-120, refer to Figure 2 and follow these steps:

1. Align the captive screws on the cFP-TC-120 with the holes on the backplane. The alignment keys on the cFP-TC-120 prevent backward insertion.

2. Press firmly to seat the cFP-TC-120 on the backplane.
3. Using a number 2 Phillips screwdriver with a shank of at least 64 mm (2.5 in.) length, tighten the captive screws to 1.1 N · m (10 lb · in.) of torque. The nylon coating on the screws prevents them from loosening.

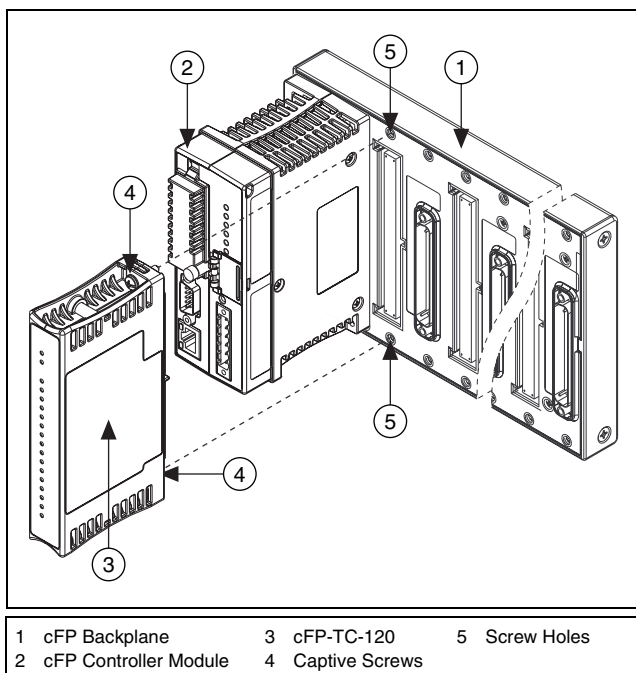

Figure 2. Installing the cFP-TC-120

Wiring the [c]FP-TC-120

The FP-TB-*x* terminal bases have connections for each of the eight differential input channels on the FP-TC-120 and a common (COM) terminal for connecting a shield to each channel. The cFP-CB-*x* connector blocks provide the same connections for the cFP-TC-120.

Table 1 lists the terminal assignments for the signals associated with each channel. The terminal assignments are the same for the FP-TB-*x* terminal bases and the cFP-CB-*x* connector blocks.

Table 1. Terminal Assignments

Channel	Terminal Numbers		
	IN(+)	IN(-)	COM
0	1	2	18
1	3	4	20
2	5	6	22
3	7	8	24
4	9	10	26
5	11	12	28
6	13	14	30
7	15	16	32



Note On the FP-TB-3 terminal base and the cFP-CB-3 connector block, use the C terminals for COM connections.

The COM terminals of all the channels are internally connected and are connected to the terminals labeled C on the terminal base. You do not need to connect a power source to the V or C terminals of the terminal base or connector block. The C and COM terminals are internally connected to the isolated ground reference of the module and to any shield connections you make, so connecting a power supply to one of these terminals may create a ground loop and cause measurements to be misreferenced. Connecting the C and COM terminals of the [c]FP-TC-120 to the V, C, or COM terminals of another FieldPoint module defeats the isolation barriers between the two modules.

Taking Measurements with the [c]FP-TC-120

The [c]FP-TC-120 has eight differential input channels. All eight channels share a common ground reference that is isolated from other modules in the FieldPoint system. Each of the input channels has a bias resistor to this isolated ground reference on the negative terminal, IN(-), and a pull-up resistor on the positive terminal, IN(+), to detect open thermocouples. Each channel has a COM terminal that connects to the isolated ground reference. Each channel is filtered, then sampled by a 16-bit analog-to-digital

converter (ADC). Figure 3 shows the input circuitry on one channel.

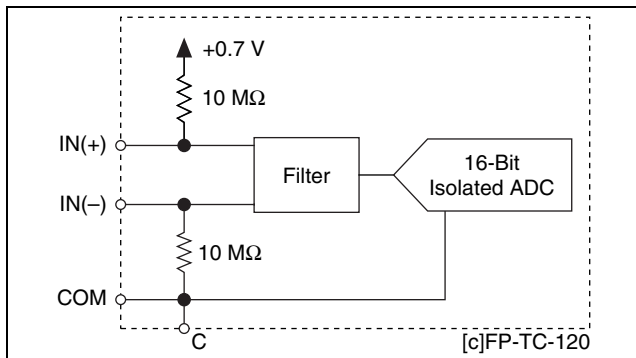

Figure 3. [c]FP-TC-120 Analog Input Circuitry on One Channel

Connecting Voltage Input Signals

Connect the positive lead of a millivolt signal to the IN(+) terminal and the negative lead to the IN(-) terminal. If you are using shielded wiring, connect one end of the shield to the COM terminal. Figure 4 shows a millivolt source connected to one channel of the [c]FP-TC-120.

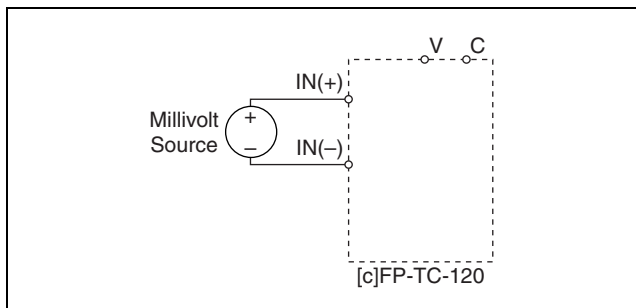

Figure 4. Connecting a Millivolt Source to the [c]FP-TC-120

The input ranges for the voltage inputs are ± 25 , ± 50 , ± 100 , and -20 to 80 mV. An input signal outside the selected input range causes the [c]FP-TC-120 to report an **Out of range** error for the affected channel. The [c]FP-TC-120 ignores any configuration of thermocouple type when you select one of these ranges.

Connecting Thermocouple Input Signals

Connect the positive lead of a thermocouple to the IN(+) terminal and the negative lead to the IN(-) terminal. If you are using shielded wiring, connect one end of the shield to the COM terminal. Thermocouple wires are color coded. The color code depends on the thermocouple type and the country of manufacture. If you are unsure which of the thermocouple leads is the positive and which is the negative, check the thermocouple documentation or the thermocouple wire spool. The [c]FP-TC-120 supports thermocouple types J, K, R, S, T, N, E, and B. Figure 5 shows a shielded thermocouple connected to one channel of the [c]FP-TC-120.

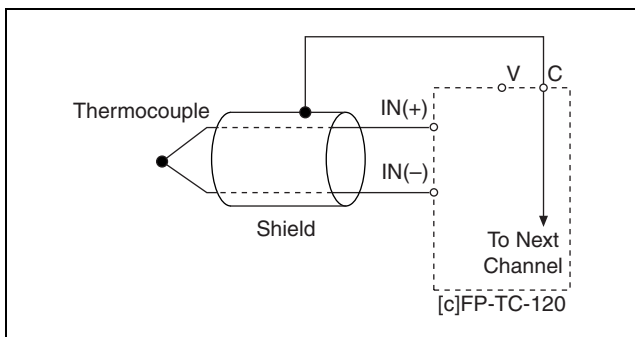

Figure 5. Connecting a Shielded Thermocouple to the [c]FP-TC-120

The [c]FP-TC-120 linearizes the thermocouple voltage and returns a reading in units of temperature. The available ranges are 0 to 2,048 K, -270 to 1,770 °C, and -454 to 3,218 °F. Temperatures outside these ranges result in an **Out of range** error for the affected channels.



Note You must configure each channel of the [c]FP-TC-120 for the type of thermocouple connected to it.

The algorithms in the [c]FP-TC-120 linearize measurements according to the National Institute of Standards and Technology NIST-175 standard for thermocouple characteristics, based on the ITS-90 International Temperature Scale. These linearization algorithms are typically accurate to within ± 0.05 °C (0.03 °F) of the NIST standard over the entire range of temperatures defined by the NIST for the supported thermocouple types.

Detecting Open Thermocouples

The [c]FP-TC-120 can detect open thermocouples. When you select a temperature range for a channel, open-thermocouple detection for that channel is enabled. When the [c]FP-TC-120 detects an open thermocouple, it reports an **Open thermocouple** error for that channel and lights the corresponding red LED.

Open-thermocouple detection works in part by using the resistors shown in Figure 3. This circuit produces a 35 nA input current at IN(-), a 35 nA output current at IN(+), and an input impedance of 20 M Ω . The open-thermocouple detection circuitry normally results in negligible errors when used with thermocouples. Other voltage sources with higher source impedance can introduce more significant errors. The following gain and offset errors result from this circuit:

- Offset error: 0.035 μ V per ohm of source resistance
- Gain error: 0.05 ppm (parts per million) per ohm of source resistance

Thus, a voltage source with a source impedance of 1 k Ω has an additional offset error of 35 μ V and an additional gain error of 50 ppm.

Cold-Junction Compensation

Connecting thermocouple leads to the terminal base or connector block creates new thermocouple junctions between the thermocouple wires and the terminals. These *cold junctions* affect the measured readings of the thermocouple. The [c]FP-TC-120 automatically enables cold-junction compensation when you select a temperature range but not when you select a voltage range. The [c]FP-TC-120 reads the temperature of the terminals from temperature-measuring elements built into all FieldPoint terminal bases and connector blocks. The module uses this temperature data to compensate for cold junctions and reports it as **CJ Temperature** in software. If the FP-TC-120 senses a temperature of less than -50 $^{\circ}$ C or more than 85 $^{\circ}$ C, the FP-TC-120 reports **Out of range** for the cold-junction temperature and for all of the channel temperatures.

For optimal cold-junction compensation, NI recommends that you use the FP-TB-3 isothermal terminal base with the FP-TC-120 and the cFP-CB-3 isothermal connector block with the cFP-TC-120.

Alternative Cold-Junction Compensation with the cFP-TC-120

If you are using an external terminal block or a cable backshell to connect to the cFP-TC-120, you can compensate for cold junctions by connecting a thermistor between pins 36 and 37. You must use a thermistor with a resistance of 5 k Ω at 25 °C. Refer to the [Specifications](#) section for information about the accuracy of the thermistor in the cFP-CB-x connector block.

Software Cold-Junction Compensation with the [c]FP-TC-120

The default setting is for the [c]FP-TC-120 to enable cold-junction compensation for all temperature measurements. To disable this feature and use a software algorithm instead, set the **CJC Source** attribute of the CJ Temperature channel to either 0 or 25 °C. Selecting one of these settings causes the [c]FP-TC-120 to assume a cold-junction temperature of either 0 or 25 °C for all temperature readings. Regardless of the setting of the CJC Source attribute, CJ Temperature continues to reflect the actual measured temperature of the terminal base or connector block. This method of software cold-junction compensation is sufficient for applications in which temperatures are fairly stable and uniform across the system.

Determining Measurement Accuracy and Minimizing Errors

It is difficult to define temperature measurement errors in simple terms because thermocouples are very nonlinear. The errors depend in part on the thermocouple type, the cold-junction temperature, the temperature being measured, and the accuracy of the thermocouple. Also, it is important to distinguish between *absolute accuracy* and *resolution*. Absolute accuracy (referred to in this document as *accuracy*) is a measure of how far off a measurement of the [c]FP-TC-120 is from the correct value. Absolute accuracy includes all gain and offset errors, differential and integral nonlinearity, quantization errors, noise errors, errors in linearization algorithms, and errors in measurement of the cold-junction temperature. Resolution refers to the smallest measurable change in a value.

The following charts show the typical and maximum errors for the different thermocouple types, both with the [c]FP-TC-120 at room temperature (15 to 35 °C) and over the full temperature range (-40 to 70 °C). These charts allow for a 0.2 °C temperature gradient across the terminal base or connector block and do not include the accuracy of the thermocouple itself.

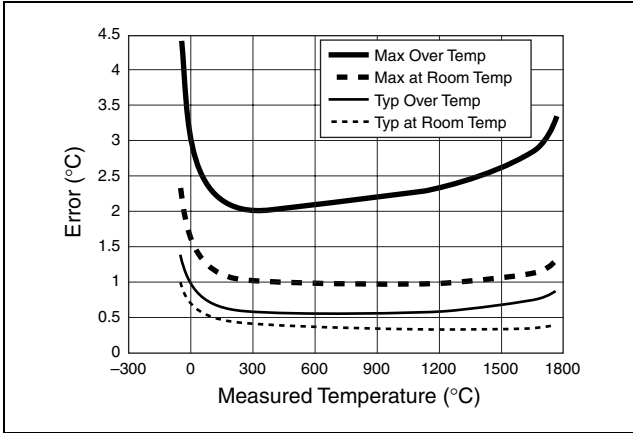

Figure 6. Type R and S Errors

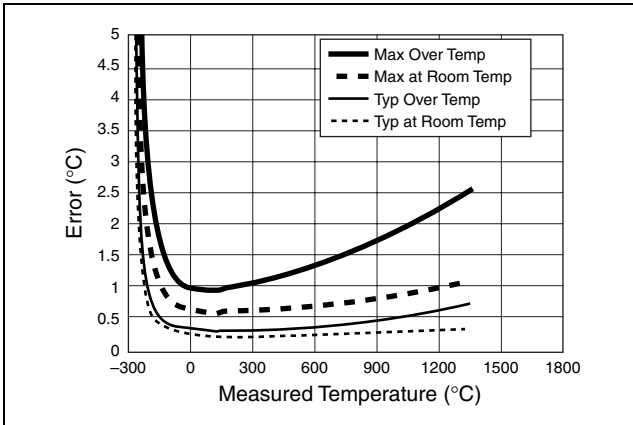

Figure 7. Type J, K, N, T, and E Errors

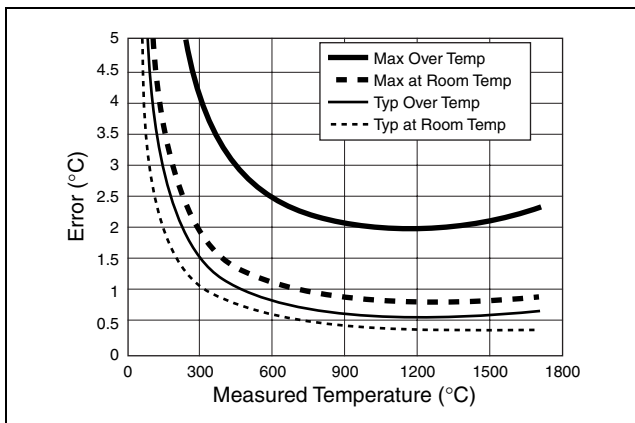

Figure 8. Type B Errors

Cold-Junction Temperature Measurement Accuracy

Heat dissipated by adjacent modules (or other nearby heat sources) can cause errors in thermocouple measurements by heating up the terminals so that they are at a different temperature than the sensor used to measure the cold junction. The thermal gradient generated across the terminals can cause the terminals of different channels to be at different temperatures, so the resulting measurement creates errors not only in absolute accuracy but also in the relative accuracy between channels. The accuracy specifications for the FP-TC-120 include the errors caused by a 0.2 °C (0.36 °F) gradient. The actual gradient you can expect to encounter depends on the terminal base or connector block you use and the details of your installation. The following sections provide guidelines for estimating and minimizing thermal gradients when using the FP-TB-*x* terminal bases. If you are using the cFP-CB-*x* connector block, refer to the *cFP-CB-*x* Compact FieldPoint Connector Blocks Operating Instructions*.

Estimating Thermal Gradients across the FP-TB-3 Isothermal Terminal Base

The FP-TB-3 is designed with *isothermal* construction to keep the terminals at the same temperature. NI recommends that you use the FP-TB-3 to ensure the best accuracy of thermocouple measurements. Adjacent FieldPoint modules (either network

modules or I/O modules) create a thermal gradient across the terminals of the FP-TB-3, which you can estimate by dividing the larger of the amounts of heat dissipated by each of the adjacent modules by 20 W/°C (11 W/°F). For example, if the FP-TB-3 is between an analog input module dissipating 0.35 W and a discrete output module dissipating 3 W, the estimated thermal gradient is $3 \text{ W} \div 20 \text{ W/}^\circ\text{C} = 0.15 \text{ }^\circ\text{C}$.

Estimating Thermal Gradients across the FP-TB-1 and FP-TB-2 Terminal Bases

The lack of isothermal construction in the FP-TB-1 and FP-TB-2 terminal bases makes them more susceptible to errors caused by thermal gradients. These terminal bases are recommended for use with thermocouple measurements only where these errors are acceptable or where precautions can be taken to minimize them. (Refer to the next section, *Minimizing Thermal Gradients when Using the [c]FP-TC-120*.) Adjacent FieldPoint modules (either network modules or I/O modules) create a thermal gradient across the terminals of the FP-TB-1, which you can estimate by dividing the larger of the amounts of heat dissipated by each of the adjacent modules by 1 W/°C (0.6 W/°F). For example, if the FP-TB-1/2 is between an analog input module dissipating 0.35 W and a discrete output module dissipating 3 W, the thermal gradient would be $3 \text{ W} \div 1 \text{ W/}^\circ\text{C} = 3 \text{ }^\circ\text{C}$. The typical thermal gradient created by the FP-TC-120 mounted on an FP-TB-1 (neglecting any adjacent modules) is about 0.2 °C.

Minimizing Thermal Gradients when Using the [c]FP-TC-120

The most common source of thermal gradients, particularly for the FP-TB-1 and FP-TB-2, is the heat generated by adjacent modules. For example, placing an FP-TB-1 next to an FP-1000 network module can create more than a 1 °C thermal gradient. You can avoid such a high thermal gradient by mounting a lower-power module or the FieldPoint Bus Extender Cable (part number 185576-15) between the FP-TC-120 and any higher-power modules in the system. This precaution is generally not necessary if you use the FP-TB-3.

Hot or cold air draft can be another source of thermal gradients. However, circulating air around nearby components may help them dissipate heat and reduce thermal gradients on the terminal base.

Thermocouple wire can also be a significant source of thermal gradients. Even the FP-TB-3 and cFP-CB-3 can be susceptible to these errors. Heat or cold may be directly conducted to the terminal junction by the thermocouple wire. If the thermocouple wires, or objects they are in contact with, such as wiring ducts, near the terminal base are at a different temperature than the terminals, the wires transfer heat to or from the terminals and cause thermal errors. To minimize these errors, follow these guidelines:

- Use small-gauge thermocouple wire. Smaller wire transfers less heat.
- Run thermocouple wiring together near the terminal base to keep the wires at the same temperature.
- Avoid running thermocouple wires near hot or cold objects.
- If you connect any extension wires to thermocouple wires, use wires made of the same conductive material.

Status Indicators

Figure 9 shows the [c]FP-TC-120 status indicators.

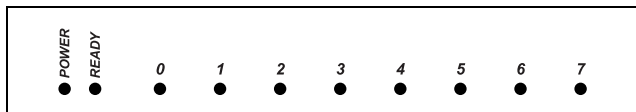

Figure 9. Status Indicators

The [c]FP-TC-120 has two green status LEDs, **POWER** and **READY**. After you insert the [c]FP-TC-120 into a terminal base or backplane and apply power to the connected network module, the green **POWER** indicator lights and the [c]FP-TC-120 informs the network module of its presence. When the network module recognizes the [c]FP-TC-120, it sends initial configuration information to the [c]FP-TC-120. After receiving this initial information, the green **READY** indicator lights and the [c]FP-TC-120 is in normal operating mode.

In addition to the green **POWER** and **READY** indicators, the [c]FP-TC-120 has eight red open-thermocouple LEDs labeled **0** to **7**. When a channel that has been configured for temperature measurements detects an open thermocouple, the red LED for that channel lights.

Upgrading the FieldPoint Firmware

You may need to upgrade the FieldPoint firmware when you add new I/O modules to the FieldPoint system. For information on determining which firmware you need and how to upgrade the firmware, go to ni.com/info and enter `fpmatrix`.

Isolation and Safety Guidelines



Caution Read the following information before attempting to connect the [c]FP-TC-120 to any circuits that may contain hazardous voltages.

This section describes the isolation of the [c]FP-TC-120 and its compliance with international safety standards. The field wiring connections are isolated from the backplane and the inter-module communication bus. The isolation is provided by the module, which has optical and galvanic isolation barriers designed and tested to protect against transient fault voltages of up to $2,300 V_{\text{rms}}$. The [c]FP-TC-120 provides *double insulation* (compliant with IEC 61010-1) for working voltages of $250 V_{\text{rms}}$ ¹. Safety standards (such as those published by UL and IEC) require the use of double insulation between hazardous voltages and any human-accessible parts or circuits.

Never try to use any isolation product between human-accessible parts (such as DIN rails or monitoring stations) and circuits that can be at hazardous potentials under normal conditions, unless the product is specifically designed for such an application, as is the [c]FP-TC-120.

Even though the [c]FP-TC-120 is designed to handle applications with hazardous potentials, follow these guidelines to ensure a safe total system:

- The [c]FP-TC-120 has a safety isolation barrier between the I/O channels and the inter-module communication bus. There is no isolation between channels unless otherwise noted. If any of the channels on a module are wired at a hazardous potential, make sure that all other devices or circuits connected to that module are properly insulated from human contact.

¹ *Working voltage* is defined as the signal voltage plus the common-mode voltage. *Common-mode voltage* is the voltage of the module with respect to ground.

- Do *not* share the external supply voltages (the V and C terminals) with other devices (including other FieldPoint devices), unless those devices are isolated from human contact.
- For Compact FieldPoint, you *must* connect the protective earth (PE) ground terminal on the cFP-BP-*x* backplane to the system safety ground. The backplane PE ground terminal has the following symbol stamped beside it: \oplus . Connect the backplane PE ground terminal to the system safety ground using 14 AWG (1.6 mm) wire with a ring lug. Use the 5/16 in. panhead screw shipped with the backplane to secure the ring lug to the backplane PE ground terminal.
- As with any hazardous voltage wiring, make sure that all wiring and connections meet applicable electrical codes and commonsense practices. Mount terminal bases and backplanes in an area, position, or cabinet that prevents accidental or unauthorized access to wiring that carries hazardous voltages.
- The isolation of the [c]FP-TC-120 is certified as double-insulated for working voltages of 250 V_{rms}. Do *not* use the [c]FP-TC-120 as the only isolating barrier between human contact and working voltages of more than 250 V_{rms}.
- Operate the [c]FP-TC-120 only at or below pollution degree 2. Pollution degree 2 means that only nonconductive pollution occurs in most cases. Occasionally, however, a temporary conductivity caused by condensation must be expected.
- Do *not* operate FieldPoint products in an explosive atmosphere or where there may be flammable gases or fumes. If you need to operate FieldPoint products in such an environment, the FieldPoint products *must* be in a suitably rated enclosure.
- Operate the [c]FP-TC-120 at or below Installation Category II. Installation Category II is for measurements performed on circuits directly connected to the low-voltage installation. This category refers to local-level distribution, such as that provided by a standard wall outlet.

Specifications

The following specifications are typical for the range -40 to 70 °C unless otherwise noted. Gain errors are given as a percentage of input signal value.

Input Characteristics

Number of channels 8

ADC resolution 16 bits

Type of ADC Delta-sigma

Voltage measurement ranges (software-selectable per channel)

Input Range	Offset Error 15 to 35 °C	Offset Error -40, 70 °C
± 25 mV	3 μ V typ, 5 μ V max	4.5 μ V typ, 13 μ V max
± 50 mV	3.5 μ V typ, 6 μ V max	5 μ V typ, 13 μ V max
± 100 mV	4 μ V typ, 7 μ V max	5.5 μ V typ, 15 μ V max
-20 to 80 mV	3.5 μ V typ, 8 μ V max	5 μ V typ, 13 μ V max

Temperature measurement ranges

Thermocouple Type	Valid Range
J	-210 to $1,200$ °C
K	-270 to $1,372$ °C
R	-50 to $1,768$ °C
S	-50 to $1,768$ °C
T	-270 to 400 °C
N	-270 to $1,300$ °C
E	-270 to $1,000$ °C
B	40 to $1,770$ °C

Cold-junction accuracy 0.15 °C typ, 0.3 °C max

There is typically an additional 0.2 °C difference between the temperature of the cold-junction sensor and that of the actual terminals.

Update rate Each channel is updated every 1.13 s

Input bandwidth.....	3 Hz
Noise rejection (at 50/60 Hz)	
Normal mode.....	85 dB
Common-mode referenced to COM.....	110 dB
Common-mode referenced to earth.....	>160 dB
Overvoltage protection	± 40 V
Input impedance.....	20 M Ω
Input current	35 nA typ, 140 nA max
Input noise	± 1 LSB peak-to-peak
Gain error	
25 °C.....	0.01% typ, 0.03% max
-40 to 70 °C	0.046% typ, 0.12% max

Physical

Indicators	Two green LEDs for POWER and READY ; eight red LEDs for open thermocouple detected
------------------	---

Weight

FP-TC-120.....	140 g (4.8 oz.)
cFP-TC-120.....	130 g (3.7 oz.)

Power Requirements

Power from network module	350 mW
---------------------------------	--------

Isolation Voltage

Isolation voltage rating	250 V _{rms} , Installation Category II
Channel-to-channel isolation.....	No isolation between channels
Transient overvoltage.....	2,300 V _{rms}

Environmental

FieldPoint modules are intended for indoor use only. For outdoor use, they *must* be mounted inside a sealed enclosure.

Operating temperature	-40 to 70 °C
Storage temperature	-55 to 85 °C

Humidity	10 to 90% RH, noncondensing
Maximum altitude.....	2,000 m
Pollution degree	2

Shock and Vibration

Operating shock (IEC 68-2-27)

cFP-TC-120	50 g, 3 ms half sine, 3 shocks; 30 g, 11 ms half sine, 3 shocks
------------------	---

Operating vibration, random (IEC 60068-2-34)

FP-TC-120.....	10–500 Hz, 2.2 g _{rms}
cFP-TC-120.....	10–500 Hz, 5 g _{rms}

Operating vibration, sinusoidal (IEC 60068-2-6)

[c]FP-TC-120	10–500 Hz, 5 g
--------------------	----------------

Safety

The [c]FP-TC-120 meets the requirements of the following standards for safety and electrical equipment for measurement, control, and laboratory use:

- EN 61010-1, IEC 61010-1
- UL 3121-1
- CAN/CSA c22.2 no. 1010.1

Electromagnetic Compatibility

CE, C-Tick and FCC Part 15 (Class A) Compliant

Electrical emissions	EN 55011 Class A at 10 m FCC Part 15A above 1 GHz
----------------------------	--

Electrical immunity	Evaluated to EN 61326: 1997/A1: 1998, Table 1
---------------------------	--



Note For full EMC compliance, you must operate this device with shielded cabling. See the Declaration of Conformity (DoC) for this product for any additional regulatory compliance information. To obtain the DoC for this product, click **Declaration of Conformity** at ni.com/hardref.nsf/.

Mechanical Dimensions

Figure 10 shows the mechanical dimensions of the FP-TC-120 installed on a terminal base. Dimensions are given in millimeters [inches]. If you are using the cFP-TC-120, refer to the Compact FieldPoint controller user manual for the dimensions and cabling clearance requirements of the Compact FieldPoint system.

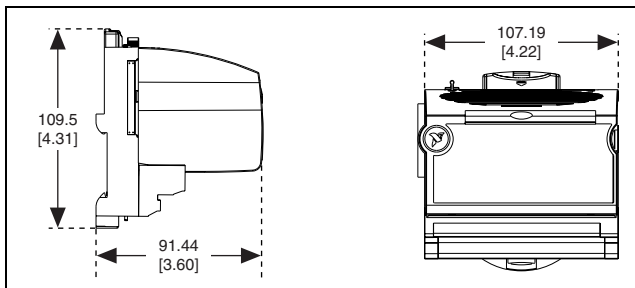

Figure 10. FP-TC-120 Mechanical Dimensions

Where to Go for Support

For more information about setting up your FieldPoint system, refer to these National Instruments documents:

- FieldPoint network module user manual
- Other FieldPoint I/O module operating instructions
- FieldPoint terminal base operating instructions

Go to ni.com/support for the most current manuals, examples, and troubleshooting information.

For telephone support in the United States, create your service request at ni.com/ask and follow the calling instructions or dial 512 795 8248. For telephone support outside the United States, contact your local branch office:

Australia 03 9879 5166, Austria 0662 45 79 90 0,
Belgium 02 757 00 20, Brazil 55 11 3262 3599,
Canada (Calgary) 403 274 9391, Canada (Montreal) 514 288 5722,
Canada (Ottawa) 613 233 5949, Canada (Québec) 514 694 8521,
Canada (Toronto) 905 785 0085, China 86 21 6555 7838,
Czech Republic 02 2423 5774, Denmark 45 76 26 00,
Finland 09 725 725 11, France 01 48 14 24 24,
Germany 089 741 31 30, Greece 01 42 96 427,
Hong Kong 2645 3186, India 91 80 4190000,
Israel 03 6393737, Italy 02 413091, Japan 03 5472 2970,

Korea 02 3451 3400, Malaysia 603 9596711,
Mexico 001 800 010 0793, Netherlands 0348 433466,
New Zealand 09 914 0488, Norway 32 27 73 00,
Poland 22 3390 150, Portugal 210 311 210, Russia 095 238 7139,
Singapore 65 6 226 5886, Slovenia 3 425 4200, South
Africa 11 805 8197, Spain 91 640 0085, Sweden 08 587 895 00,
Switzerland 056 200 51 51, Taiwan 02 2528 7227,
United Kingdom 01635 523545