

COMPREHENSIVE SERVICES

We offer competitive repair and calibration services, as well as easily accessible documentation and free downloadable resources.

SELL YOUR SURPLUS

We buy new, used, decommissioned, and surplus parts from every NI series. We work out the best solution to suit your individual needs.

 Sell For Cash  Get Credit  Receive a Trade-In Deal

OBSOLETE NI HARDWARE IN STOCK & READY TO SHIP

We stock **New**, **New Surplus**, **Refurbished**, and **Reconditioned** NI Hardware.



Bridging the gap between the manufacturer and your legacy test system.

 1-800-915-6216

 www.apexwaves.com

 sales@apexwaves.com

All trademarks, brands, and brand names are the property of their respective owners.

Request a Quote

 **CLICK HERE**

FP-TB-2

FP-TB-1/2/3

FieldPoint Terminal Bases

These operating instructions describe the installation, features, and characteristics of the FP-TB-1, FP-TB-2, and FP-TB-3.

Features

The FP-TB-1, FP-TB-2, and FP-TB-3 are FieldPoint terminal bases with the following features:

- Works with all FieldPoint I/O modules (the FP-TB-3 is designed specifically to work with thermocouple I/O modules)
- V and C terminals provide external supply voltages common to all channels
- DIN-rail mounting or panel mounting
- 32 terminals available for field connections (FP-TB-3 has 16)
- Available with screw terminals (FP-TB-1 and FP-TB-3) or spring terminals (FP-TB-2)
- Isothermal construction (FP-TB-3) minimizes temperature gradients when using thermocouples
- -40 to 70 °C operation

The FP-TB-1, FP-TB-2, and FP-TB-3 terminal bases provide the intra-system communication link between FieldPoint I/O modules and network modules, provide a means for wiring field connections, and provide the mounting mechanism. You can choose your terminal base depending on the type of field wiring terminal you prefer: screw terminal or spring terminal.

FieldPoint™, National Instruments™, NI™, and ni.com™ are trademarks of National Instruments Corporation. Product and company names mentioned herein are trademarks or trade names of their respective companies. For patents covering National Instruments products, refer to the appropriate location: **Help»Patents** in your software, the `patents.txt` file on your CD, or `ni.com/patents`.

Mounting the FP-TB-1/2/3 on a DIN Rail



Caution To avoid damaging the network module and terminal base, make sure that power is not applied to the network module while you are installing or removing a terminal base.

FieldPoint terminal bases have simple rail clips for reliable mounting on a standard 35 mm DIN rail. Follow these steps to mount the terminal base on a DIN rail.

1. Write down the serial number, located on the back of the terminal base, before you mount it on the DIN rail.
2. Use a flathead screwdriver to open the DIN rail clip to the unlocked position, as shown in Figure 1.

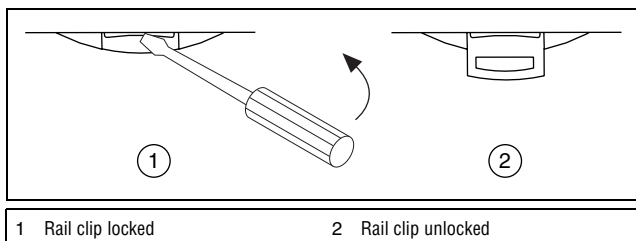

Figure 1. Unlocking the Rail Clip

3. Attach the lip on the rear of the terminal base onto the top of a 35 mm DIN rail and press it down onto the DIN rail, as shown in Figure 2.

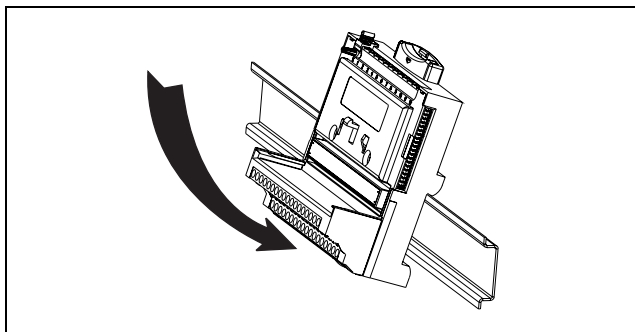

Figure 2. Attaching the Terminal Base to a DIN Rail

- Slide the terminal base along the DIN rail until its local bus connector mates with the connector of the terminal base or network module adjacent to it.
- After the terminal base is in position, lock it to the DIN rail by pushing the rail clip to the locked position.
- To add more terminal bases, install them on the rail and connect their local bus connectors together.
- Place the protective cover onto the local bus connector of the last terminal base on the bank, as shown in Figure 3. Add rail locks by sliding them on and tightening the screws.

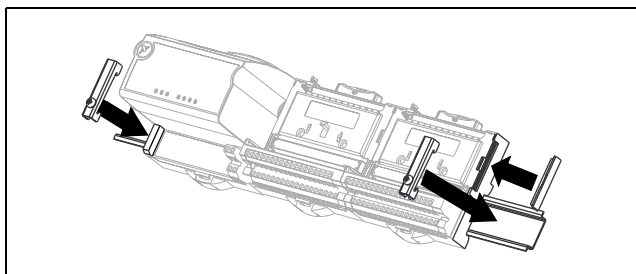

Figure 3. Adding Rail Locks and Protective Cover

Mounting the FP-TB-1/2/3 to a Panel



Caution To avoid damaging the network module and terminal base, make sure that power is not applied to the network module while you are installing or removing a terminal base.

Follow these steps to mount the terminal base on a wall or panel.

- Use Figure 4 to locate where to drill the mounting holes on the panel. Dimensions are given in millimeters [inches].

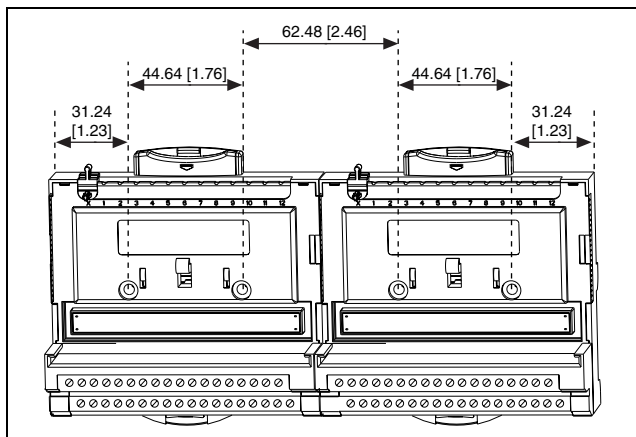

Figure 4. Locating the Mounting Holes

2. When you have located and drilled the mounting holes, mount the terminal base as shown in Figure 5.

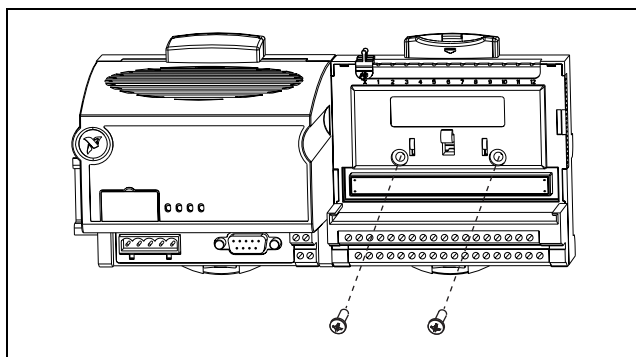

Figure 5. Mounting the Terminal Base

3. Place the protective cover over the local bus connector of the last terminal base in the bank.

Mounting I/O Modules on the Terminal Base

Refer to Figure 6 and follow these steps to install an I/O module on the terminal base.

1. Slide the terminal base key to the appropriate position for the I/O module. The position marked *X* is a universal position that works for all modules.
2. Align the alignment slots on the I/O module with the guide rails on the terminal base.

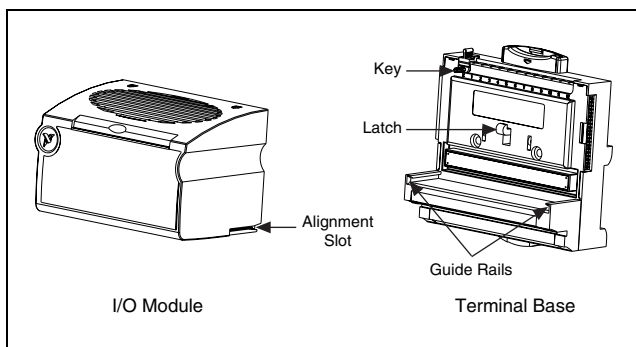

Figure 6. Mounting the I/O Module on the Terminal Base

3. Press firmly to seat the I/O module on the terminal base. When the module is firmly seated, the terminal base latch locks it into place and the ejector button on the top of the terminal base pops up.
4. To remove an I/O module, press the ejector button on top of the terminal base and pull off the module.

Field Wiring

The FP-TB-1 and FP-TB-2 provide four dedicated terminals and 32 numbered terminals defined by the I/O module. The terminals are designed for 16–26 AWG copper conductor wire with 7 mm (0.28 in.) of insulation stripped from the end as shown in Figure 7. Use only copper wire unless you are working with a sensing device, such as a thermocouple, that requires a different kind of wire.

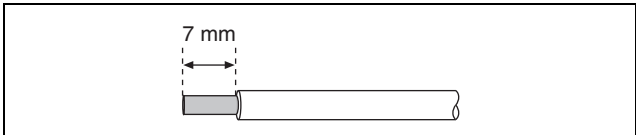

Figure 7. Conductor Wire with the Correct Strip Length

The four dedicated terminals are two V and two C terminals, one of each at both ends of the terminal base. The two V terminals are internally connected by the terminal base, as are the two C terminals. Generally, these terminals are intended to connect external power supplies to field devices. FieldPoint I/O modules get their power from the network module through the backplane, and in most cases require no external power for proper operation. Refer to the appropriate I/O module operating instructions for details on the use of these terminals and the other 32 terminals. The FP-TB-3 provides two dedicated C terminals and 16 numbered terminals defined by the I/O module. Although the FP-TB-3 is designed specifically to work with thermocouple modules, I/O modules that do not require external power and that only use terminals 1 to 16 can be used with the FP-TB-3.



Caution Before you connect wires to the terminal base, make sure that power is not applied to it.

Connecting Wires to the FP-TB-1 or FP-TB-3

Follow these steps to connect wires to the FP-TB-1 or FP-TB-3.

1. Loosen the terminal screw you want to wire.
2. Insert the wire in the terminal.
3. Tighten the screw terminal to 0.5–0.6 N · m (4.4–5.3 lb · in.) of torque.

Connecting Wires to the FP-TB-2

Follow these steps to connect wires to the FP-TB-2.

1. Insert a screwdriver into the slot directly below the terminal number and push the screwdriver downward into the slot. You may need to push hard. This forces the spring-loaded terminal to open.
2. Insert the wire in the terminal.
3. Withdraw the screwdriver, allowing the spring terminal to clamp securely onto the wire.

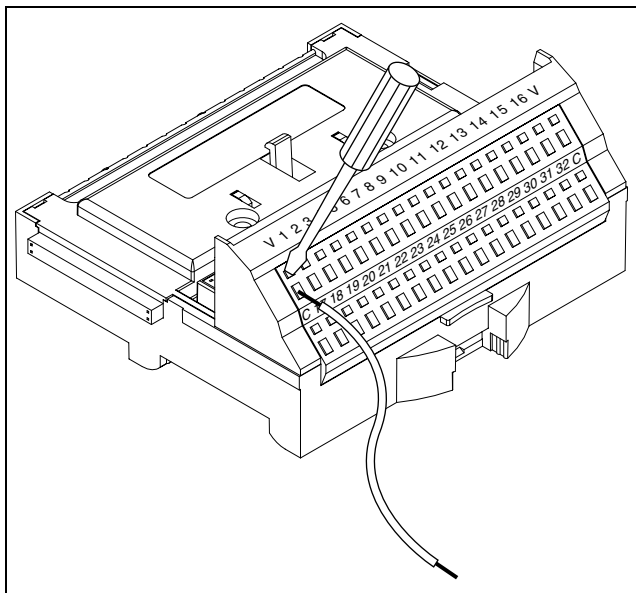

Figure 8. Connecting Wires to the Spring Terminals of the FP-TB-2

Powering the FieldPoint System

Consider the following points when connecting power to the FieldPoint system.

- The total current flowing through the V and C terminals must be limited to 10 A. If you have a single external supply for the field devices of more than one module, wire the supply to the V and C terminals as shown in Figure 9.

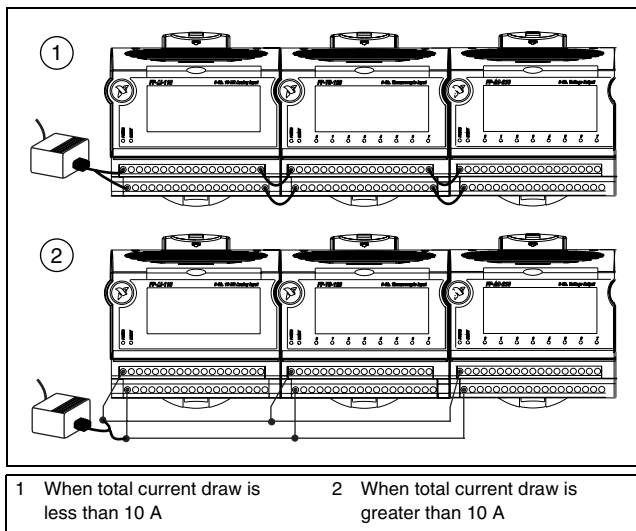

Figure 9. Connecting Power for Current Draws Below and Above 10 A



Caution Cascading power from neighboring bases or network modules defeats isolation between cascaded modules.

- When total current draw is less than 3 A, you can use a single terminal for the return path. If the total current draw is greater than 3 A, you should use separate C terminals, as shown in Figure 10.

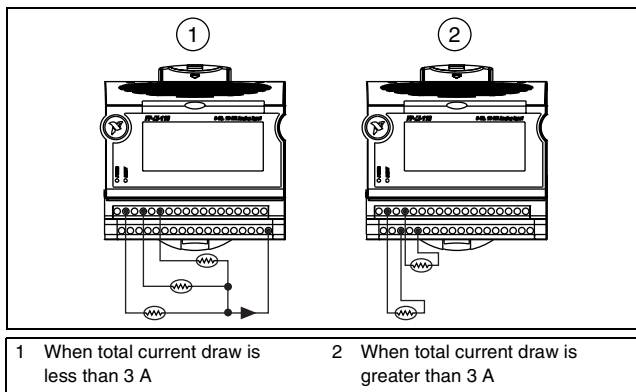

Figure 10. Connecting Power for Current Draws Below and Above 3 A

- You need to wire power to the terminal bases only if you want to use the terminal bases to route power to field devices or if the I/O module requires it. FieldPoint I/O modules get their power from the network module through the backplane and, in most cases, require no external power for proper operation. Refer to your I/O module operating instructions for details. In Figure 11, shades of gray indicate differing voltage potentials.

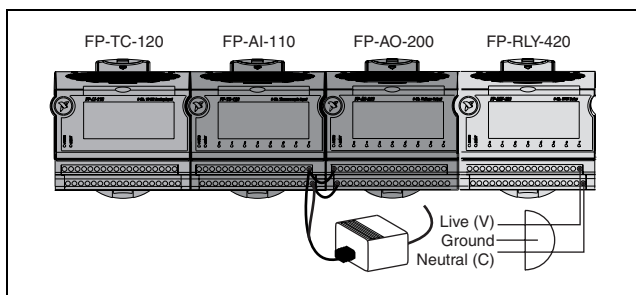

Figure 11. Different Voltage Potentials



Caution Cascading power from neighboring bases or network modules defeats isolation between cascaded modules.

- You may want to use separate power supplies for I/O modules both to prevent power dips caused by field devices from disrupting the operation of the network module and to maintain

the isolation barrier between the I/O modules and the network module. Figure 12 shows an example configuration with both separate power supplies and cascading power.

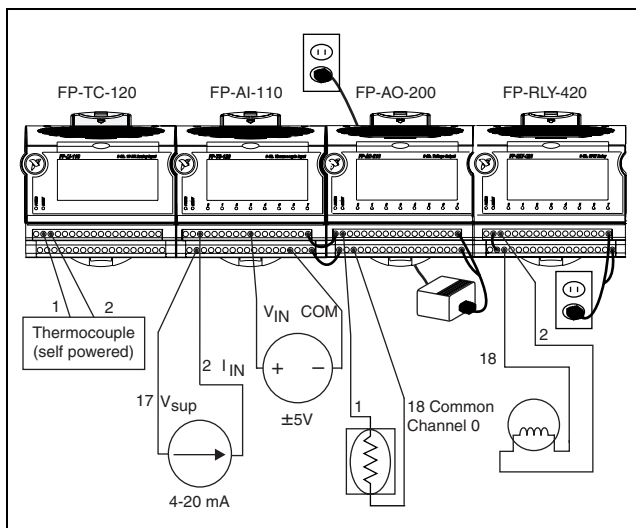

Figure 12. Example Power Supply Configuration for a FieldPoint Bank



Caution Cascading power from neighboring bases or network modules defeats isolation between cascaded modules.

Thermocouple Wiring

The FP-TC-120 thermocouple input module has the ability to measure the temperature of the terminals on any of the FieldPoint terminal bases. This measurement is called the *cold junction temperature* and indicates the temperature of the junctions between your thermocouple wire and the screw terminals. This measurement is used internally by the FP-TC-120 to correct for the thermoelectric voltages that are generated at these junctions.

Heat dissipated by adjacent modules (or other nearby heat sources) can cause errors in thermocouple measurements by heating up the terminals so that they are at a different temperature than the sensor used to measure the cold junction. The thermal gradient generated across the terminals can cause the terminals of different channels

to be at different temperatures, and so the resulting measurement creates not only errors in absolute accuracy but also in the relative accuracy between channels. The accuracy specifications for the FP-TC-120 include the errors caused by a 0.2 °C (0.36 °F) gradient. The actual gradient you can expect to encounter depends on the terminal base you use and the details of your installation. The following sections provide guidelines for estimating and minimizing thermal gradients.

Estimating Thermal Gradients with the FP-TB-3 Isothermal Terminal Base

The FP-TB-3 is designed with *isothermal* construction to keep the terminals at the same temperature. It is the terminal base recommended for the best accuracy of thermocouple measurements. Adjacent FieldPoint modules (either network modules or I/O modules) create a thermal gradient across the terminals of the FP-TB-3, which you can estimate by dividing the larger of the amounts of heat dissipated by each of the adjacent modules by 20 W/°C (11 W/°F). For example, if the FP-TB-3 is between an analog input module dissipating 0.35 W and a discrete output module dissipating 3 W, the thermal gradient would be $3 \text{ W} \div 20 \text{ W/}^\circ\text{C} = 0.15 \text{ }^\circ\text{C}$.

Estimating Thermal Gradients with the FP-TB-1 or FP-TB-2 Terminal Bases

The lack of isothermal construction in the FP-TB-1 and FP-TB-2 terminal bases makes them more susceptible to errors caused by thermal gradients. These terminal bases are recommended for use with thermocouple measurements only if such errors are acceptable or if they can be minimized, as described in the *Minimizing Thermal Gradients* section. Adjacent FieldPoint modules (either network modules or I/O modules) create a thermal gradient across the terminals of the FP-TB-1, which you can estimate by dividing the larger of the amounts of heat dissipated by each of the adjacent modules by 1 W/°C (0.6 W/°F). For example, if the FP-TB-1/2 is between an analog input module dissipating 0.35 W and a discrete output module dissipating 3 W, the thermal gradient would be $3 \text{ W} \div 1 \text{ W/}^\circ\text{C} = 3 \text{ }^\circ\text{C}$. The typical thermal gradient created by the FP-TC-120 mounted on an FP-TB-1 (neglecting any adjacent modules) is about 0.2 °C.

Minimizing Thermal Gradients

The most common source of thermal gradients, particularly for the FP-TB-1 and FP-TB-2, is the heat generated by adjacent modules. For example, placing an FP-TB-1 next to an FP-1000 network module can create more than a 1 °C thermal gradient. Mounted thermocouple modules can be separated from the higher-power modules by the lowest-power modules in your system or by the FieldPoint Bus Extender Cable (part number 185576-15). This precaution is generally not necessary with the FP-TB-3.

Hot or cold air draft can be another source of thermal gradients. It is usually best to avoid having air blowing directly on the terminals, although circulating air around other nearby components may help them dissipate their heat and cause them to be less of a source of thermal gradients on the terminal base.

Thermocouple wire also has the potential to be a significant source of thermal gradients. Even the FP-TB-3 can be susceptible to these errors. Heat or cold may be directly conducted to the terminal junction by the thermocouple wire. If the thermocouple wires, or objects they are in contact with, such as wiring ducts, near the terminal base are at a different temperature than the terminals, the wires transfer heat to or from the terminals and cause thermal errors. To minimize these errors, follow these guidelines:

- Use small-gauge thermocouple wire. Smaller wires transfer less heat.
- Run thermocouple wires together near the terminal base to keep them at the same temperature.
- Avoid running thermocouple wires near hot or cold objects.

Specifications

The following specifications are typical for a range of -40 to 70 °C, unless otherwise noted.

Installation

Terminal wiring 16–26 AWG copper
conductor wire with 7 mm
(0.28 in.) of insulation
stripped from the end¹

¹ Use only copper conductor wire unless you are working with a sensing device, such as a thermocouple, that requires a different kind of wire.

Torque for screw terminals 0.5–0.6 N · m
(4.4–5.3 lb · in.)

Physical

Weight

FP-TB-1 210 g (7.4 oz)
FP-TB-2 160 g (5.7 oz)
FP-TB-3 240 g (8.5 oz)

Maximum Working Voltage

Maximum working voltage refers to the signal voltage plus the common-mode voltage.

Channel-to-earth 250 V, Installation
Category II¹

Channel-to-channel See I/O module operating
instructions



Caution Improper wiring may defeat isolation barrier.

Environmental

FieldPoint modules are intended for indoor use only.

Operating temperature –40 to 70 °C

Storage temperature –55 to 85 °C

Humidity 10 to 90% RH,
noncondensing

Maximum altitude 2,000 m

Pollution degree 2

Safety

The FP-TB-1/2/3 meets the requirements of the following standards for safety and electrical equipment for measurement, control, and laboratory use:

- EN 61010-1:1993/A2:1995, IEC 61010-1:1990/A2:1995
- UL 3121:1998
- CAN/CSA c22.2 no. 1010.1:1992/A2:1997

¹ May vary by I/O module. See I/O module operating instructions.

Electromagnetic Compatibility

CE, C-Tick and FCC Part 15 (Class A) Compliant

Electrical emissions EN 55011 Class A at 10 m
FCC Part 15A above 1 GHz

Electrical immunity Evaluated to EN 61326:
1997/A1: 1998, Table 1



Note For full EMC compliance, you must operate this device with shielded cabling. See the Declaration of Conformity (DoC) for this product for any additional regulatory compliance information. To obtain the DoC for this product, click **Declaration of Conformity** at ni.com/hardref.nsf/.

Mechanical Dimensions

Figure 13 show the mechanical dimensions of the FP-TB-1/2/3 with an I/O module installed. Dimensions are given in millimeters [inches].

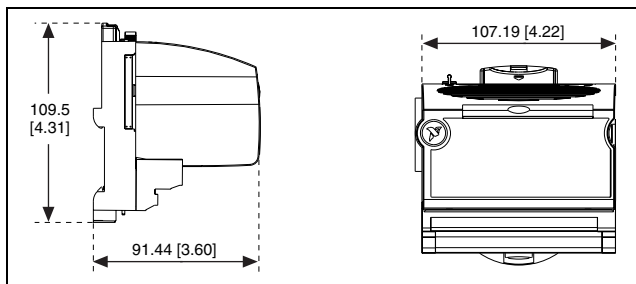

Figure 13. Mechanical Dimensions

Where to Go for Support

For more information about setting up your FieldPoint system, refer to these National Instruments documents:

- Your FieldPoint network module user manual
- Your other FieldPoint I/O module operating instructions
- Your FieldPoint terminal base operating instructions

Go to ni.com/support for the most current manuals, examples, and troubleshooting information.

For telephone support in the United States, create your service request at ni.com/ask and follow the calling instructions or dial 512 795 8248. For telephone support outside the United States, contact your local branch office:

Australia 03 9879 5166, Austria 0662 45 79 90 0, Belgium 02 757 00 20,
Brazil 011 3262 3599, Canada (Calgary) 403 274 9391,
Canada (Montreal) 514 288 5722, Canada (Ottawa) 613 233 5949,
Canada (Québec) 514 694 8521, Canada (Toronto) 905 785 0085,
China (Shanghai) 021 6555 7838, China (ShenZhen) 0755 3904939,
Czech Republic 02 2423 5774, Denmark 45 76 26 00,
Finland 09 725 725 11, France 01 48 14 24 24, Germany 089 741 31 30,
Greece 30 1 42 96 427, Hong Kong 2645 3186, India 91 80 4190000,
Israel 03 6393737, Italy 02 413091, Japan 03 5472 2970,
Korea 02 3451 3400, Malaysia 603 9596711, Mexico 001 800 010 0793,
Netherlands 0348 433466, New Zealand 09 914 0488,
Norway 32 27 73 00, Poland 0 22 3390 150, Portugal 351 210 311 210,
Russia 095 238 7139, Singapore 6 2265886, Slovenia 386 3 425 4200,
South Africa 11 805 8197, Spain 91 640 0085, Sweden 08 587 895 00,
Switzerland 056 200 51 51, Taiwan 02 2528 7227,
United Kingdom 01635 523545