GPIB-140B

User Manual

2023-11-21



Contents

GPIB-140B User Manual.....	3
Basic Information.....	3
Unpacking.....	4
Hardware Symbol Definitions.....	5
Hardware Overview.....	5
Hardware Connections.....	11
Hardware Configuration.....	14
Theory of Operation.....	19
Product Certifications and Declarations.....	35
NI Services.....	36

GPIB-140B User Manual

This document provides installation, configuration, and reference information for the GPIB-140B fiber optic GPIB extender.

© 2021 National Instruments Corporation. All rights reserved. Refer to the <National Instruments>_Legal Information directory for information about NI copyright, patents, trademarks, warranties, product warnings, and export compliance.

Basic Information

This section provides general information about the GPIB-140B.

Conventions

GPIB-140B	Refers to a GPIB extender that extends the GPIB to a maximum distance of 1 km.
GPIB extender	Refers to the bus extender.
IEEE 488 and IEEE 488.2	Refers to the ANSI/IEEE Standard 488.1-1987 and the ANSI/IEEE Standard 488.2-1992, respectively, which define the GPIB.

Kit Contents

- A GPIB-140B bus extender
- 12 V DC power supply

This power adapter can be used with an input AC voltage between 100 V AC and 240 V AC. Verify that the voltage you will be using is in the input range of this power adapter.



Note If using a different adapter than what ships with the GPIB-140B, ensure that the adapter provides 9 V DC to 15 V DC and has appropriate safety certification marks for country of use.

Optional Equipment

The following table lists some cables available for the GPIB-140B. For a complete list of GPIB accessories and ordering information, refer to the pricing section of the **Fiber-Optic Cable** and **GPIB Cable** product pages at ni.com.



Note The GPIB-140B is designed for use with multi-mode fiber-optic cable. Do not use with single-mode cable.

Table 1. GPIB-140B Optional Cables

Cable/Accessory	Part Number	
GPIB T7 fiber-optic cable - extends up to 1 km (10 m to 1000 m lengths)	182805-010/020/030/050/100/200/500/01K	
Type X2 double-shielded cable with shielded plug/receptacles	0.5 m: 763061-005	3 m: 763061-003
	1 m: 763061-01	4 m: 763061-04
	2 m: 763061-02	



Note To meet FCC emission limits for this device, use only with shielded cables and accessories. If you operate this equipment with a non-shielded cable, it may interfere with radio and television reception.

Related Documentation

The following documents contain information that you may find helpful as you read this manual:

- GPIB 140B Specifications
- GPIB-140B Safety, Environmental, and Regulatory Information
- ANSI/IEEE Standard 488.1-1987, **IEEE Standard Digital Interface for Programmable Instrumentation**
- ANSI/IEEE Standard 488.2-1992, **IEEE Standard Codes, Formats, Protocols, and Common Commands**

Unpacking

The GPIB-140B ships in an antistatic package to prevent electrostatic discharge (ESD). ESD can damage several components on the device.

To avoid ESD damage in handling the device, take the following precautions:



- Ground yourself with a grounding strap or by touching a grounded object.
- Touch the antistatic package to a metal part of your computer chassis before removing the device from the package.

Remove the device from the package and inspect it for loose components or any other signs of damage. Notify NI if the device appears damaged in any way. Do not install a damaged device.

Store the device in the antistatic package when the device is not in use.

Hardware Symbol Definitions

The following symbols are marked on the GPIB-140B.

	Caution Take precautions to avoid injury. Refer to the GPIB-140B Safety, Environmental, and Regulatory Information for safety guidelines.
	At the end of the product life cycle, all NI products must be disposed of according to local laws and regulations. For more information about how to recycle NI products in your region, visit ni.com/environment/weee .
	NI 符合中国电子信息产品中限制使用某些有害物质指令(RoHS)。关于 NI 中国 RoHS 合规性信息，请登录 ni.com/environment/rohs_china 。(For information about China RoHS compliance, go to ni.com/environment/rohs_china .)

Hardware Overview

This section describes the GPIB-140B fiber optic GPIB extender.

GPIB-140B Description



Note The GPIB-140B bus extender can communicate with either a GPIB-140B or a GPIB-140A bus extender. The GPIB-140B cannot communicate with a GPIB-140, a GPIB-140/2 or a GPIB-140A/2 bus extender since it uses a different protocol to communicate across the fiber-optic cable.

The GPIB-140B is a high-speed bus extender that you can use in pairs with multi-mode fiber-optic cable to connect two separate GPIB systems in a functionally transparent manner.

The two bus systems are physically separate, as shown in the following figure.

Figure 1. Typical Extension System (Physical Configuration)

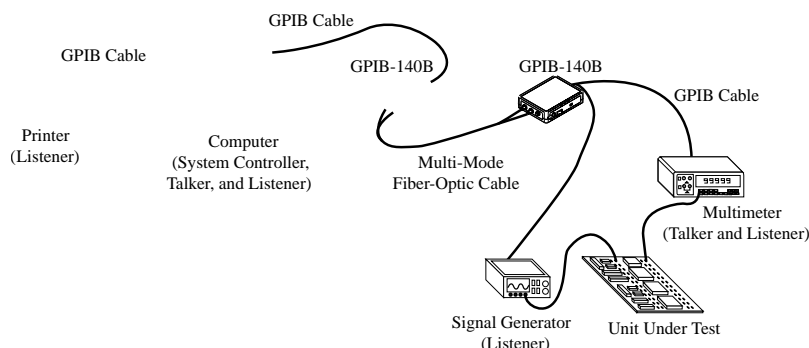

The devices logically appear to be located on the same bus, as shown in the following figure.

Figure 2. Typical Extension System (Logical Configuration)

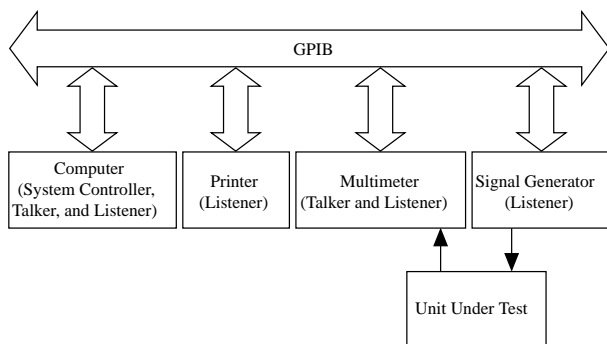

The bus extender complies with the specifications of the ANSI/IEEE Standard 488.1-1987 and the ANSI/IEEE Standard 488.2-1992, including the Find Listeners

protocol. With the GPIB extenders, you can overcome the following two configuration restrictions imposed by IEEE 488:

- A cable length limit of 20 m total per contiguous bus or 2 m per each device on the bus, whichever is smaller.
- An electrical loading limit of 15 devices per contiguous bus.

Each GPIB-140B system extends the GPIB to a maximum distance of 1 km, and extends the loading limit to 28 devices (including the GPIB extenders), without sacrificing speed or performance. You can connect these point-to-point extension systems in series for longer distances or in star patterns for additional loading. Using the HS488 protocol, the maximum data transfer rate over the extension is greater than 2.8 MBytes/s. The GPIB extenders use a buffered transfer technique with a serial extension bus, which maximizes performance and minimizes the cabling cost. Furthermore, the extender does not affect the transfer rate between devices on the same side of the extension. The GPIB extender can also check for errors to make sure that the data transmitted successfully over the fiber-optic link. Because the GPIB-140B is a functionally transparent extender, the GPIB communications and control programs that work with an unextended system also work with an extended system. However, the Parallel Poll Response Modes section describes one exception to this transparency in conducting parallel polls.

GPIB-140B Dimensions

The following dimensional drawings apply to the GPIB-140B. To find detailed dimensional drawings and 3D models visit ni.com/dimensions and search for the device number.

Figure 3. GPIB-140B Top and Bottom Dimensions

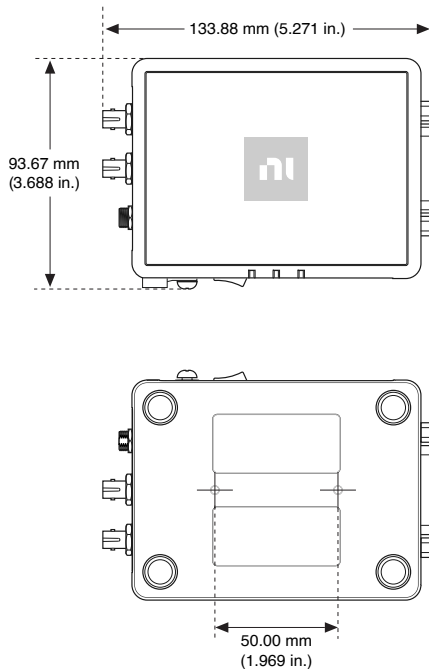
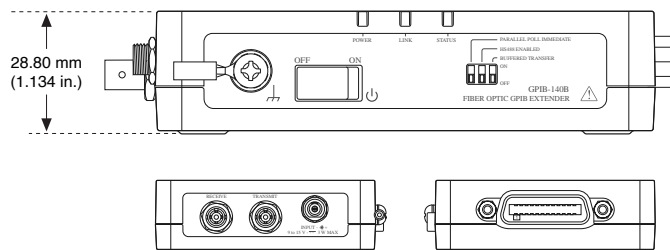

Figure 4. GPIB-140B Side Dimensions



Grounding the GPIB-140B

You must connect the GPIB-140B grounding terminal to the grounding electrode system of the facility.



Note For more information about ground connections, visit ni.com/r/emcground.

What to Use

- Standard ring lug

- Wire, 1.3 mm (16 AWG) or larger
- Screwdriver, Phillips #2

What to Do

Complete the following steps to ground the GPIB-140B.

Figure 5. Installing the Ground Wire

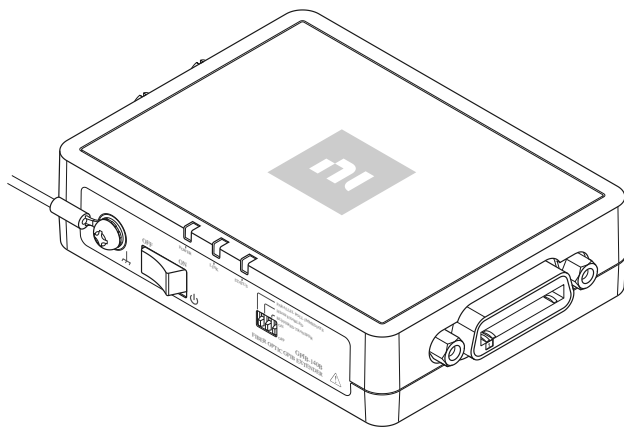

1. Attach the ring lug to the wire.
2. Remove the grounding screw from the grounding terminal on the side panel of the product.
3. Fasten the ring lug to the grounding terminal.
4. Tighten the grounding screw to 1.3 N · m (11.5 in-lb) of torque.
5. Attach the other end of the wire to the chassis safety ground using a method that is appropriate for your application.

LED Indicators

Table 2. LED State/Device Status

LED	Color	Behavior	Description
POWER	Green	Solid	GPIB-140B is powered on.
	Red	Solid	GPIB-140B is powered on, but the input

LED	Color	Behavior	Description
			supply voltage is either out of the operating range or the overcurrent protection is active.
	—	Off	The supply voltage is connected in reverse polarity (when the device is powered on), or the device is powered off.
LINK	Green	Solid	Both GPIB extenders are powered on and the fiber-optic transmission cable is properly connected between them. The GPIB-140B bus extenders are ready to use.
	—	Off	The fiber-optic cable is defective or disconnected, or the remote GPIB-140B is turned off.
STATUS	Green	Flashing, 10 Hz	Activity is present on the GPIB bus.
	Red	Solid	The fiber-optic cable is either defective or disconnected, or the GPIB-140B is turned off.
	Red	Flashing, 10 Hz	The GPIB-140B is receiving corrupted data, and starts re-transmission. The red LED turns off after 50 ms and flashes green when

LED	Color	Behavior	Description
			the extender receives retransmitted data bytes without error.
	—	Off	There is no activity on the GPIB bus.

DIP Switches

The 3-bit DIP switch sets the operation mode of the GPIB extender. The default switch setting is for unbuffered transfer mode, latched parallel poll response (PPR), and HS488 disabled mode, as shown here.

Figure 6. Default DIP Switch Setting

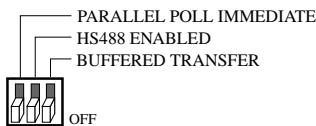

Verify that the DIP switches on your GPIB extender are in these default positions. If you need to change these settings, refer to [Hardware Configuration](#) for instructions about how to set the operation mode for your application.

Hardware Connections

This section explains how to connect the GPIB-140B to the fiber-optic cables and power supply, and how to run a self test to verify operation.

Connecting the Cables



Note The GPIB-140B is designed for use with multi-mode fiber-optic cable. Do not use with single-mode cable.

Complete the following steps to connect a multi-mode fiber-optic cable to both GPIB extenders.

1. Make sure that each GPIB-140B extender is powered off.
2. Connect the two connectors on each end of the fiber-optic cable to your GPIB extenders, as follows:

- a. As shown in the following figure, align the connector marked **T** (transmit) with the connector labeled **TRANSMIT** on the side of the GPIB extender. Align the connector marked **R** (receive) with the connector labeled **RECEIVE** on the side of the GPIB extender.

Figure 7. Connecting the Fiber-Optic Cable to Both GPIB Extenders

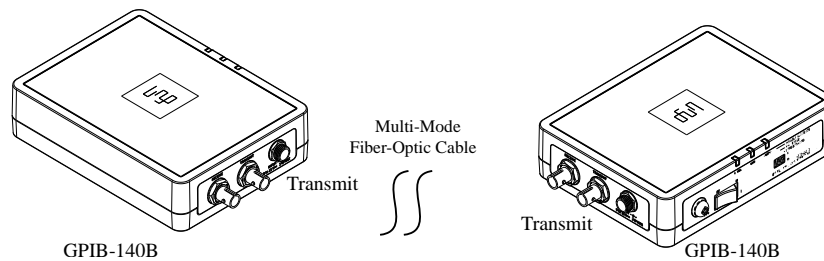

- b. Remove the caps on the connectors.
 - c. Align the notch on each cable connector to the slot of the fiber-optic connector on the GPIB extender.
 - d. Firmly push in the cable connector and rotate the sleeve clockwise until it locks on to the side notch of the fiber-optic connector on the GPIB extender.
3. Connect the end of the extender with the GPIB connector to your GPIB system. Make sure to follow all IEEE 488 cabling restrictions. For typical restrictions, refer to [Configuration Requirements](#).

Connecting the External Power Supply

Complete the following steps to connect the external power supply.

1. Plug the utility power cord of your 12 V DC power supply into a 100 V AC to 240 V AC electrical outlet.
2. Plug the other end of the power cord into the power supply.
3. Connect the 12 V DC output of the power supply into the DC power connector on the GPIB-140B by rotating the sleeve by hand until it is firmly screwed in place.
4. Power on the GPIB-140B extender; the **POWER** LED lights green. If the LED does not light green make sure that the supply voltage is in the acceptable range.

The **LINK** LED lights green when multiple GPIB extenders are properly connected and turned on.



Note Refer to [LED Indicators](#) for detailed information about the behavior of each LED.

Verifying the Connection

Each GPIB extender has a self test that determines whether the GPIB extender receivers, transmitters, and packet transmission and reception circuitry are working properly.

Complete the following steps to run the self-test.

1. Power off the GPIB extender.
2. Disconnect the fiber-optic cable from the GPIB extender.
3. Power on the GPIB extender.
The **POWER** LED lights green, indicating that power is supplied to the extender. The **LINK** LED remains off, and the **STATUS** LED lights red.
4. Connect the connector marked **T** (transmit) on one end of the fiber-optic cable to the connector marked **TRANSMIT** on the side of the GPIB extender.
5. Connect the connector marked **R** (receive) on the opposite end of the fiber-optic cable to the connector marked **RECEIVE** on the side of the GPIB extender.

Figure 8. GPIB Extender Self-Test Configuration

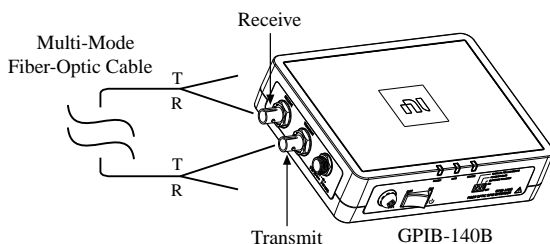

The **LINK** LED lights green, indicating that a properly working cable is connected. The **STATUS** LED remains off during the self-test.

If the **LINK** LED is off and the **STATUS** LED is either solid or flashing red, there may be an issue with the fiber-optic transmission cable. Complete the following steps to troubleshoot:

1. Verify that the fiber-optic cable is properly connected to the GPIB extender as described in steps 4 and 5 above. If the problem persists, continue to the next step.
2. Repeat steps 4 and 5 using the unconnected ends of the fiber-optic cable. If switching the fiber-optic cable connectors solves the problem, you need to replace your fiber-optic cable. Refer to the **Fiber-Optic Cable** product page at ni.com for cable information.
If switching the fiber-optic cable connectors does not solve the problem, continue to the next step.
3. Repeat steps 4 and 5 using a different fiber-optic cable. If the problem persists, you might need to replace your GPIB extender. For more information, contact NI for support.



Note Refer to [LED Indicators](#) for detailed information about the behavior of each LED.

Hardware Configuration

Hardware Configuration

This section describes how to configure the operation modes supported by the GPIB-140B.

Data Transfer Modes

The GPIB extender has two data transfer modes—unbuffered mode and buffered mode. The data transfer mode determines how data is transmitted across the extension.

Selecting a Data Transfer Mode

Refer to the following descriptions when selecting a data transfer mode.

Unbuffered Mode

In unbuffered mode, each data byte is transmitted using the GPIB double-interlocked handshaking protocol. For long data streams, transfers are slower than transfers using buffered mode. However, the GPIB extension is transparent in unbuffered mode.

Buffered Mode

In buffered mode, the GPIB extenders use FIFO (first-in-first-out) buffers to buffer data between the remote and local units. For long data streams, the data throughput is much higher than with unbuffered mode.

However, a few applications may not operate properly in buffered mode. For example, a GPIB device on the local side of the extension is addressed to talk, another device on the remote side is addressed to listen. When the Talker sources data bytes, the GPIB extenders accept the data bytes and store them in a FIFO buffer. At the same time, the GPIB extenders read data from the FIFO buffer and source data bytes to the Listener. If the FIFO buffer contains data, the number of bytes sourced by the Talker differs from the number of bytes accepted by the Listener.

GPIB command bytes are not stored in the FIFO buffers; they are transmitted using the GPIB double-interlocked handshaking protocol.

Setting the Data Transfer Mode

The two GPIB extenders in your extension system must use the same data transfer mode.

To use buffered mode, set the **BUFFERED TRANSFER** DIP switch to the ON position, as shown in the following figure. To use unbuffered mode, set this switch to the OFF position.

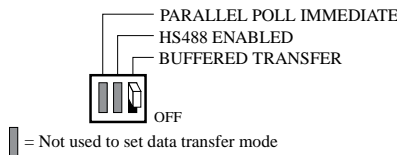
Figure 9. DIP Switch Setting for Buffered Mode

HS488 Mode

The GPIB extender can handle data transfers using the HS488 protocol. HS488 transfers data between two or more devices using a noninterlocked handshaking protocol. You can use HS488 to transfer data at rates higher than rates possible using the IEEE 488 protocol. For more information about HS488, refer to [Introduction to HS488](#).

Selecting an HS488 Mode

Refer to the following descriptions when selecting the HS488 mode.

HS488 Disabled

If you disable HS488, the GPIB extender sources and accepts data using a three-wire handshaking protocol, even if both the Talker and Listener can transfer data using the HS488 protocol.

HS488 Enabled

After the Talker indicates that it wants to issue HS488 transfers, HS488 is enabled and the GPIB extender accepts data using the HS488 protocol. Also, when talking, the GPIB extender always tries to use the HS488 mode. In HS488 mode, FIFO buffers buffer data during HS488 transfers, even if the data transfer mode is set to unbuffered. When you use the HS488 protocol with the GPIB extender, you should set the GPIB cable length to 5 m for both the local and the remote system. To do so, use your IEEE 488.2 software configuration utility.

Setting the HS488 Mode

The two GPIB extenders in your extension system do not need to use the same HS488 mode, however, the system uses the maximum data transfer rate when both sides in your extension system use HS488.

To enable HS488, set the **HS488 ENABLED** DIP switch to the ON position, as shown in the following figure. To disable HS488, set this switch to the OFF position.

Figure 10. DIP Switch Setting for Enabled HS488

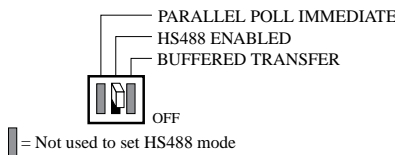

Parallel Poll Response Modes

According to IEEE 488, devices must respond to a parallel poll within 200 ns after the Controller-In-Charge (CIC) asserts the Identify (IDY) message—Attention (ATN) and End or Identify (EOI). The CIC waits at least 2 μ s before reading the Parallel Poll Response (PPR). In many cases, a remote device on an extended system cannot respond to parallel polls this quickly because of cable propagation delays. To solve this problem, use one of the following two solutions in your application:

- If possible, specify in your application that the CIC must allow enough time to receive the response. For more information, refer to [Immediate PPR Mode](#). If you are using NI-488.2 software, you can use the NI-488.2 Configuration utility to set the amount of time that the CIC waits.
- Execute two consecutive parallel polls and use the second response. For more information, refer to [Latched PPR Mode](#).

PPR Mode Considerations

When selecting a PPR mode, consider the type of Controller present in your GPIB system and the length of cable between the GPIB-140B extenders. However, if your application does not use parallel polls, you do not need to select a PPR mode.

Some Hewlett Packard GPIB Controllers remain in a parallel poll state with IDY asserted if they are not performing another function. A change in the response interrupts the application. In some Controllers, the IDY signal is toggled on and off,

and you can change the duration of the signal to accommodate delayed responses over extenders. If you are using these types of Controllers, you should set the GPIB extender to immediate PPR mode.

Most other Controllers pulse the IDY signal for approximately 2 μ s and expect a response within that time. If you are using this type of Controller and if the cable between the extenders is longer than 60 m, you should set the GPIB extender to latched PPR mode. For shorter cable distances, use immediate PPR mode.

The two GPIB extenders in your extension system do not need to use the same PPR mode. Select the PPR mode of the local GPIB extender based on the Controllers on the local GPIB system. Likewise, select the PPR mode of the remote GPIB extender based on the Controllers on the remote GPIB system. If no Controllers are physically connected to one of the GPIB extenders, the PPR mode of that GPIB extender has no effect on your system.

Selecting a PPR Mode

Refer to the following descriptions when selecting the PPR mode.

Immediate PPR Mode

In immediate PPR mode, the GPIB extenders do not use the internal PPR data register. When a Controller on the local system asserts IDY, the local extender sends the IDY message to the remote bus and the response is returned as fast as propagation delays permit. Your application must allow enough time to receive the response.

Latched PPR Mode

In latched PPR mode, the GPIB extenders use an internal PPR data register. When a Controller on the local system asserts IDY, the local extender sends the contents of the PPR data register to the local data lines. At the same time, a parallel poll message is sent to the remote bus. When the local system unasserts IDY, the PPR from the remote system is loaded into the internal PPR data register. Consequently,

the register always contains the response of the previous complete poll. To obtain the response of both local and remote systems, your application should execute two consecutive parallel polls and use the second response.

The software driver library of most Controllers contains an easy-to-use parallel poll function. For example, if the function is called `ibrpp` and your application is written in BASIC, the sequence to execute a poll in latched PPR mode might be similar to the following sequence:

```
CALL ibrpp (brd0%, ppr%)
CALL ibrpp (brd0%, ppr%)
IF ppr > 0 GOTO 300
```

Setting the PPR Mode

To enable immediate PPR mode, set the **PARALLEL POLL IMMEDIATE** DIP switch to the ON position, as shown in the following figure. To enable latched PPR mode, set this switch to the OFF position.

Figure 11. DIP Switch Setting for Immediate PPR Mode

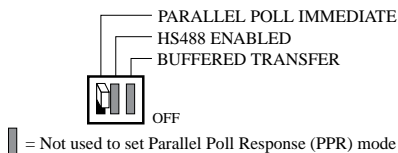

Theory of Operation

This section describes how the GPIB extender circuitry operates.

This section assumes that you are familiar with GPIB. If you are a first-time user or if you would like to review the basics about GPIB, refer to [GPIB Basics](#).

The following figure shows the five layers of a GPIB extender. To form a complete link, you can connect each layer to the corresponding layer of another extender at the remote side.

Figure 12. GPIB Extender Block Diagram

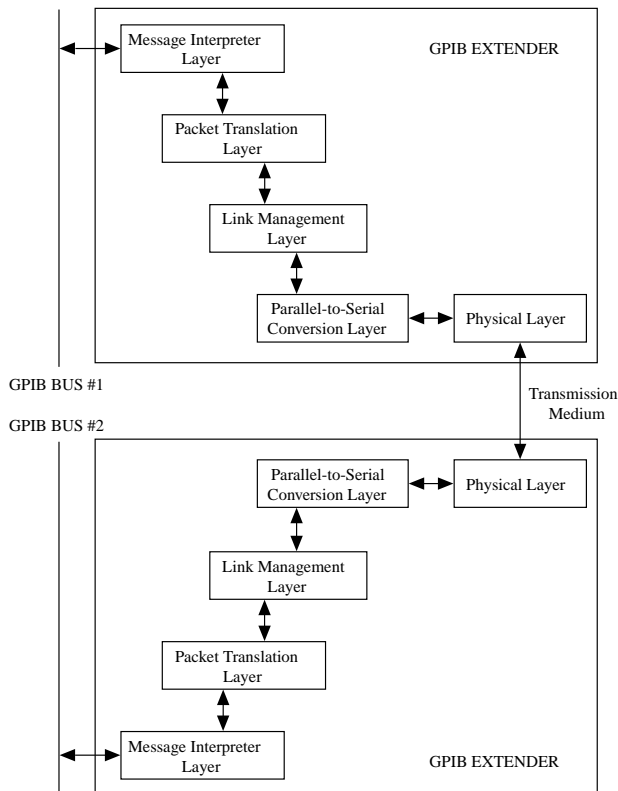

Message Interpreter Layer

The Message Interpreter Layer handles the handshake between the GPIB extender and other devices on the GPIB. At the same time, the layer monitors the activities that occur on the GPIB, translates them into equivalent local and remote GPIB messages, and sends these messages to the Packet Translation Layer.

Packet Translation Layer

The Packet Translation Layer converts the messages that it receives to packets and sends them to the Link Management Layer. It can also receive packets from the Link Management Layer and convert them back to local or remote GPIB messages.

Link Management Layer

The Link Management Layer receives packets from the Packet Translation Layer. It sends the packets to the Parallel-to-Serial Conversion Layer and it stores them in a

local buffer. If a transmission error occurs, the Link Management Layer can re-send the packets from this local buffer. The Link Management Layer also receives packets from the Parallel-to-Serial Conversion Layer and checks the packets for transmission errors. If the Link Management Layer does not detect an error, it sends the packets to the Packet Translation Layer. However, if it detects a transmission error, then it re-transmits the packets.

Parallel-to-Serial Conversion Layer

The Parallel-to-Serial Conversion Layer accepts packets from the Link Management Layer, converts them into serial data, and sends the data to the Physical Layer. It also extracts serial bits from the Physical Layer, reconstructs them back into packets, and sends them to the Link Management Layer.

Physical Layer

The Physical Layer transmits and receives serial data over the fiber-optic link.

GPIB Basics

This section describes the basic concepts of GPIB, including its physical and electrical characteristics, and configuration requirements.

The ANSI/IEEE Standard 488.1-1987, also known as General Purpose Interface Bus (GPIB), describes a standard interface for communication between instruments and controllers from various vendors. It contains information about electrical, mechanical, and functional specifications. GPIB is a digital, 8-bit parallel communications interface with data transfer rates of 1 Mbyte/s and higher, using a three-wire handshake. The bus supports one System Controller, usually a computer, and up to 14 additional instruments. The ANSI/IEEE Standard 488.2-1992 extends IEEE 488.1 by defining a bus communication protocol, a common set of data codes and formats, and a generic set of common device commands.

Types of Messages

Interconnected GPIB devices communicate by passing messages through the interface system, including device-dependent messages and interface messages.

- Device-dependent messages, also called **data** or **data messages**, contain device-specific information, such as programming instructions, measurement results, machine status, and data files.
- Interface messages, also called **commands** or **command messages**, manage the bus itself. Interface messages initialize the bus, address and unaddress devices, and set device modes for remote or local programming. The term **command** as used here does not refer to device instructions, which are also called commands. Those device-specific instructions are data messages.

Talkers, Listeners, and Controllers

GPIB devices can be Talkers, Listeners, or Controllers. A Talker sends out data messages. Listeners receive data messages. The Controller, usually a computer, manages the flow of information on the bus. It defines the communication links and sends GPIB commands to devices.

Some devices are capable of playing more than one role. A digital voltmeter, for example, can be a Talker and a Listener. If your system has a NI GPIB interface and software installed, it can function as a Talker, Listener, and Controller.

The GPIB is like a typical computer bus, except that the typical computer has circuit cards interconnected via a backplane bus, whereas the GPIB has standalone devices interconnected via a cable bus.

The role of the GPIB Controller is similar to the role of the CPU of a computer, but a better analogy is to the switching center of a city telephone system. The switching center (Controller) monitors the communications network (GPIB). When the center (Controller) notices that a party (device) wants to make a call (send a data message), it connects the caller (Talker) to the receiver (Listener).

The Controller addresses a Talker and a Listener before the Talker can send its message to the Listener. After the message is transmitted, the Controller may unaddress both devices.

Some bus configurations do not require a Controller. For example, one device may always be a Talker (called a Talk-only device) and there may be one or more Listen-only devices.

A Controller is necessary when the active or addressed Talker or Listener must be changed. The Controller function is usually handled by a computer.

With the GPIB interface board and its software your personal computer plays all three roles.

- Controller—to manage the GPIB
- Talker—to send data
- Listener—to receive data

Controller-In-Charge and System Controller

You can have multiple Controllers on the GPIB, but only one Controller at a time can be the active Controller, or Controller-In-Charge (CIC). The CIC can be either active or inactive (standby). Control can pass from the current CIC to an idle Controller, but only the System Controller, usually a GPIB interface, can make itself the CIC.

GPIB Signals and Lines

Devices on the bus communicate by sending messages. Signals and lines transfer these messages across the GPIB interface, which consists of 16 signal lines and 8 ground return (shield drain) lines. The 16 signal lines are discussed in the following sections.

Data Lines

Eight data lines, DIO1 through DIO8, carry both data and command messages.

Handshake Lines

Three hardware handshake lines asynchronously control the transfer of message bytes between devices. This process is a three-wire interlocked handshake, and it guarantees that devices send and receive message bytes on the data lines without transmission error. The following table summarizes the GPIB handshake lines.

Table 4. GPIB Handshake Lines

Line	Description
NRFD (not ready for data)	Listening device is ready/not ready to receive a message byte. Also used by the Talker to signal high-speed GPIB transfers.
NDAC (not data accepted)	Listening device has/has not accepted a message byte.
DAV (data valid)	Talking device indicates signals on data lines are stable (valid) data.

Interface Management Lines

Five hardware lines manage the flow of information across the bus. The following table summarizes the GPIB interface management lines.

Table 4. GPIB Interface Management Lines

Line	Description
ATN (attention)	Controller drives ATN true when it sends commands and false when it sends data messages.
IFC (interface clear)	System Controller drives the IFC line to initialize the bus and make itself CIC.
REN (remote enable)	System Controller drives the REN line to place devices in remote or local program mode.
SRQ (service request)	Any device can drive the SRQ line to asynchronously request service from the Controller.
EOI (end or identify)	Talker uses the EOI line to mark the end of a data message. Controller uses the EOI line when it conducts a parallel poll.

Physical and Electrical Characteristics

Devices are usually connected with a cable assembly consisting of a shielded 24-conductor cable with both a plug and receptacle connector at each end, as shown in the following figure.

Figure 13. GPIB Connector and Signal Assignments

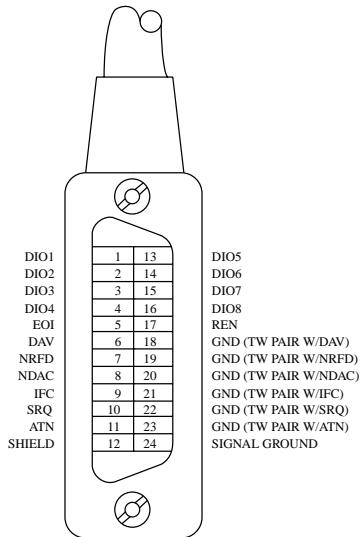

With this design, you can link devices in a linear configuration, a star configuration, or a combination of the two configurations. The following figure shows both linear and star configurations.

Figure 14. Linear and Star System Configuration

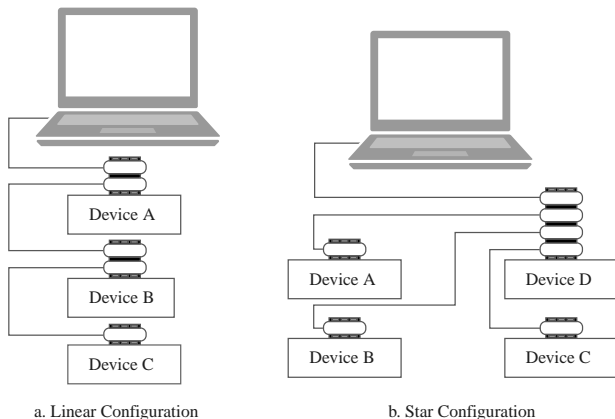

The standard connector is the Amphenol or Cinch Series 57 **Microribbon** or **Amp Champ** type. For special interconnection applications, you use an adapter cable using a non-standard cable and/or connector.

The GPIB uses negative logic with standard TTL (transistor-transistor logic) level. For example, when DAV is true, it is a TTL low level (≤ 0.8 V), and when DAV is false, it is a TTL high level (≥ 2.0 V).

Configuration Requirements

To achieve the high data transfer rate that the GPIB was designed for, you must limit the number of devices on the bus and the physical distance between devices. The following restrictions are typical:

- A maximum separation of 4 m between any two devices and an average separation of 2 m over the entire bus.
- A maximum total cable length of 20 m.
- A maximum of 15 devices connected to each bus, with at least two-thirds powered on.

For high-speed operation, the following restrictions apply:

- All devices in the system must be powered on.
- Cable lengths must be as short as possible with up to a maximum of 15 m of cable for each system.
- There must be at least one equivalent device load per meter of cable.

If you want to exceed these limitations, you can use a bus expander to increase the number of device loads. You can order bus expanders from NI.

Introduction to HS488

This section describes HS488 and the sequence of events in high-speed data transfers.

NI has designed a high-speed data transfer protocol for IEEE 488 called HS488. This protocol increases performance for GPIB reads and writes up to 8 MBytes/s, depending on your system.

If HS488 is enabled, the TNT4882C hardware implements high-speed transfers automatically when communicating with HS488 instruments. If you attempt to enable HS488 on a GPIB interface that does not have the TNT4882C hardware, the ECAP error code is returned.

Objectives

The following sections describe the objectives of HS488.

Faster Transfer Rates

HS488 enables transfer rates that are substantially faster than the IEEE 488 standard. In small systems, the raw transfer rate can be up to 8 MBytes/s. The faster raw transfer rates improve system throughput in systems where devices send long blocks of data. The physical limitations of the cabling system, however, limit the transfer rate.

Compatibility with IEEE 488 Devices

HS488 is a superset of the IEEE 488 standard; thus, you can mix IEEE 488.1, IEEE 488.2, and HS488 devices in the same system.

When connected to an HS488 device, the Controller does not need to be capable of HS488 non-interlocked transfers. While ATN is asserted, the Controller sources multiline messages to HS488 devices just as it sources multiline messages to any IEEE 488 devices.

Automatic HS488 Detection

Addressed HS488 devices can detect whether other addressed devices are capable of HS488 transfers without the interaction of the Controller.

Compatibility with the IEEE 488.2 Standard

The HS488 protocol requires no changes to the IEEE 488.2 standard. Also, HS488 devices do not need to be compliant with IEEE 488.2.

Same Cabling Restrictions as IEEE 488.1

Systems that meet the IEEE 488.1 requirements for high-speed operation also meet the HS488 requirements. HS488 cabling requirements are also the same as the requirements in the IEEE 488.1 standard.

However, using HS488 does not reduce software overhead. Also, system throughput increases depend on data block size.

IEEE 488.1 Requirements for High-Speed Operation (T_1 Delay ≥ 350 ns)

The IEEE 488.1 standard requires that devices used in high-speed operation must use three-state, 48 mA drivers on most signals. Each device must add no more than 50 pF capacitance on each signal, and all devices must be powered on.

The total cable length in a system must be no more than 15 m, or 1 m times the number of devices in the system.

HS488 System Requirements

An HS488 system must meet the IEEE 488.1 requirements and it must implement the following three new interface functions:

- Talking devices must use the **Source Handshake Extended (SHE)** interface function, which is an extension of the IEEE 488.1 SH function.
- Listening devices must use the **Acceptor Handshake Extended (AHE)** interface function, which is an extension of the IEEE 488.1 AH function. Accepting devices must have a buffer of at least 3 bytes to store received data.
- HS488 devices must implement the **Configuration (CF)** interface function. At system power on, the Controller uses previously undefined multiline messages to configure HS488 devices. The CF function enables devices to interpret these multiline messages.

Sequence of Events in Data Transfers

The following figure shows a typical IEEE 488.1 data transfer.

Figure 15. IEEE 488.1 Transfers

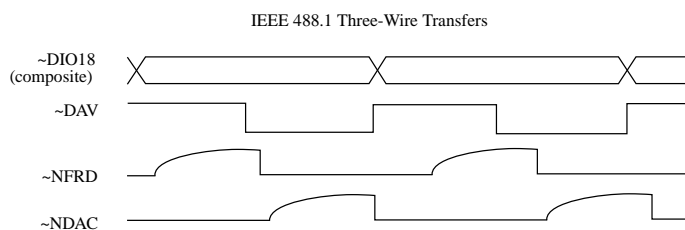

The following figure shows an HS488 data transfer. The HS488 protocol modifies the IEEE 488.1 SH and AH functions. At the beginning of each data transfer, the HS488 SHE and AHE functions determine whether all active Talkers and Listeners are capable of HS488 transfers. If the addressed devices are HS488-capable, they use the HS488 noninterlocked handshake protocol for that data transfer. If any

addressed device is not HS488-capable, the transfer continues using the standard three-wire handshake.

Figure 16. HS488 Transfers

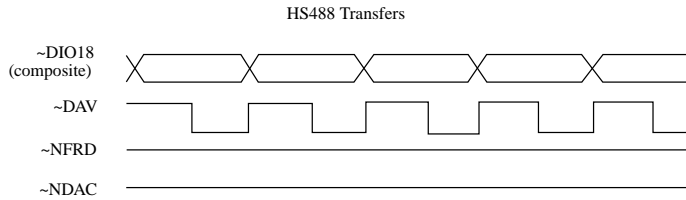

Case 1: Talker and Listener are HS488 Capable

The following figure and procedure describe a typical sequence of events in an HS488 data transfer in which both the Talker and Listener are HS488-capable.

Figure 17. HS488-Capable Talker and Listener

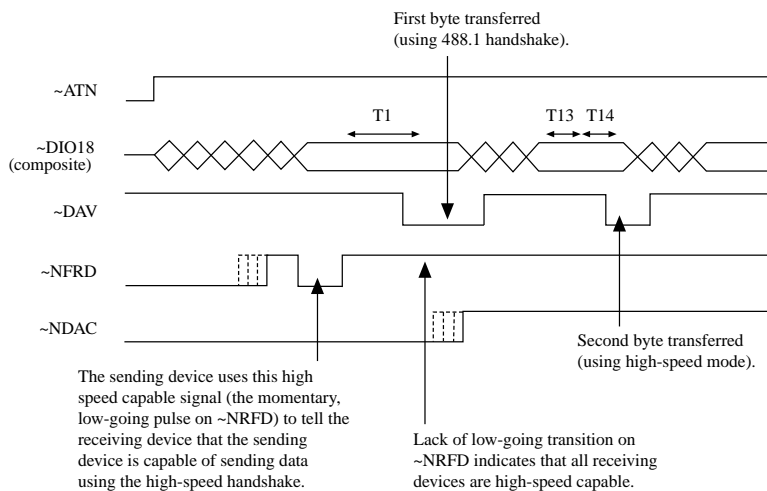

1. The Controller addresses devices and becomes Standby Controller by unasserting ATN.
2. The Listener asserts NDAC and NFRD.
3. The Listener unasserts NFRD as it becomes ready to accept a byte.
4. After allowing time for the Listener to detect NFRD unasserted, the Talker indicates that it is HS488-capable by sending the HSC message. To send the HSC message true, the Talker asserts the NFRD signal.

5. After allowing time for the Listener to respond to the HSC message, the Talker sends the HSC message false. To send the HSC message false, the Talker unasserts the NRFD signal.
6. When the Talker has a byte ready to send, it drives the data on the DIO signal lines, allows some settling time, and asserts DAV.
7. The Listener unasserts NDAC. HS488-capable Listeners do not assert NRFD as IEEE 488.1 devices would, so the Talker determines that the addressed Listener is HS488-capable.
8. The Talker unasserts DAV and drives the next data byte on the GPIB.
9. After allowing some settling time, the Talker asserts DAV.
10. The Listener latches the byte in response to the assertion (falling) edge of DAV.
11. After allowing some hold time, the Talker unasserts DAV and drives the next data byte on the DIO signal lines.

Steps 9-11 are repeated for each data byte.

Case 2: Talker Is HS488-Capable, But Listener Is Not HS488-Capable

The following figure and procedure describe a typical sequence of events in an HS488 data transfer in which the Talker is HS488-capable, but the Listener is not.

Figure 18. HS488-Capable Talker

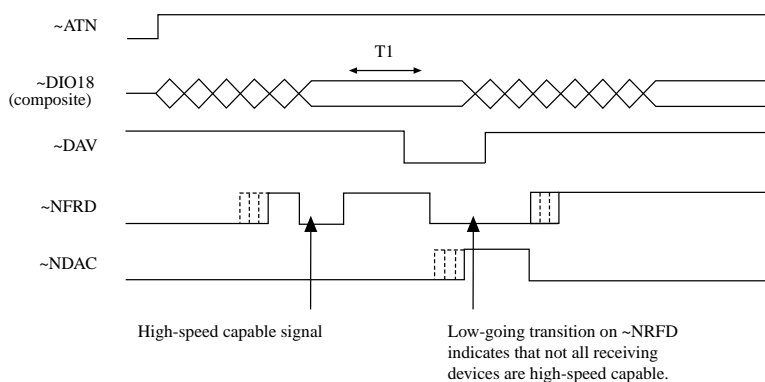

Steps 1–6 in the sequence are identical to steps 1–6 in the previous procedure [Case 1: Talker and Listener are HS488 Capable](#). The Listener ignores the HSC message from the Talker.

Then, the IEEE 488.1 Listener enters ACDS and asserts NRFD. As a result, the Talker determines that the addressed Listener is not HS488-capable. The Talker sources bytes using the IEEE 488.1 protocol.

Case 3: Talker Is Not HS488-Capable, But Listener Is HS488-Capable

The Talker does **not** send an HSC message to the Listener, but sources bytes using the IEEE 488.1 protocol.

The addressed Listener (HS488 or IEEE 488.1) accepts bytes using the IEEE 488.1 standard three-wire handshake, as shown in the following figure.

Figure 19. Listener Is HS488-Capable

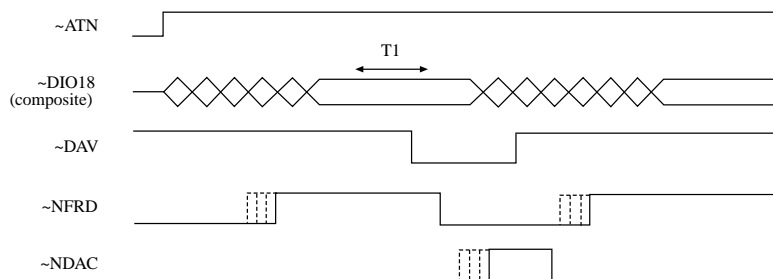

System Configuration

The HS488 AHE and SHE interface functions depend on several time delays. Some of these delays are a function of the total system cable length.

The Controller must communicate this system configuration data to HS488 devices after the system powers on. The Controller configures HS488 devices by sourcing the following two multiline messages while ATN is true:

- **Configuration Enable (CFE)**—The Controller sends the CFE message by driving a bit pattern (1E hex) that the IEEE 488.1 standard does not define on the DIO signal lines. The CFE message enables HS488 devices to interpret the SCG message that follows.
- **Secondary Command Group (SCG)**—This message contains the configuration data. The Secondary Command has the bit pattern 6n hex, where n is the meters of cable in the system. The SCG includes CFG1-CFG15 in the [Multiline Interface Messages](#) section.

Multiline Interface Messages

This section lists the multiline interface messages and describes the mnemonics and messages that correspond to the interface functions.

The multiline interface messages are commands defined by the IEEE 488 standard. The messages are sent and received with ATN asserted. The interface functions include initializing the bus, addressing and unaddressing devices, and setting device modes for local or remote programming. For more information about these messages, refer to the ANSI/IEEE Standard 488.1-1987, IEEE Standard Digital Interface for Programmable Instrumentation.

Table 5. Multiline Interface Messages

Hex	Dec	ASCII	Message		Hex	Dec	ASCII	Message
00	0	NUL	—		20	32	SP	MLA0
01	1	SOH	GTL		21	33	!	MLA1
02	2	STX	—		22	34	"	MLA2
03	3	ETX	—		23	35	#	MLA3
04	4	EOT	SDC		24	36	\$	MLA4
05	5	ENQ	PPC		25	37	%	MLA5
06	6	ACK	—		26	38	&	MLA6
07	7	BEL	—		27	39	'	MLA7
08	8	BS	GET		28	40	(MLA8
09	9	HT	TCT		29	41)	MLA9
0A	10	LF	—		2A	42	*	MLA10
0B	11	VT	—		2B	43	+	MLA11
0C	12	FF	—		2C	44	,	MLA12
0D	13	CR	—		2D	45	-	MLA13
0E	14	SO	—		2E	46	.	MLA14
0F	15	SI	—		2F	47	/	MLA15
10	16	DLE	—		30	48	0	MLA16
11	17	DC1	LLO		31	49	1	MLA17
12	18	DC2	—		32	50	2	MLA18
13	19	DC3	—		33	51	3	MLA19
14	20	DC4	DCL		34	52	4	MLA20

Hex	Dec	ASCII	Message	Hex	Dec	ASCII	Message
15	21	NAK	PPU	35	53	5	MLA21
16	22	SYN	—	36	54	6	MLA22
17	23	ETB	—	37	55	7	MLA23
18	24	CAN	SPE	38	56	8	MLA24
19	25	EM	SPD	39	57	9	MLA25
1A	26	SUB	—	3A	58	:	MLA26
1B	27	ESC	—	3B	59	;	MLA27
1C	28	FS	—	3C	60	<	MLA28
1D	29	GS	—	3D	61	=	MLA29
1E	30	RS	—	3E	62	>	MLA30
1F	31	US	CFE	3F	63	?	UNL
40	64	@	MTA0	60	96	`	MSA0, PPE
41	65	A	MTA1	61	97	a	MSA1, PPE, CFG1
42	66	B	MTA2	62	98	b	MSA2, PPE, CFG2
43	67	C	MTA3	63	99	c	MSA3, PPE, CFG3
44	68	D	MTA4	64	100	d	MSA4, PPE, CFG4
45	69	E	MTA5	65	101	e	MSA5, PPE, CFG5
46	70	F	MTA6	66	102	f	MSA6, PPE, CFG6
47	71	G	MTA7	67	103	g	MSA7, PPE, CFG7

Hex	Dec	ASCII	Message		Hex	Dec	ASCII	Message
48	72	H	MTA8		68	104	h	MSA8, PPE, CFG8
49	73	I	MTA9		69	105	i	MSA9, PPE, CFG9
4A	74	J	MTA10		6A	106	j	MSA10, PPE, CFG10
4B	75	K	MTA11		6B	107	k	MSA11, PPE, CFG11
4C	76	L	MTA12		6C	108	l	MSA12, PPE, CFG12
4D	77	M	MTA13		6D	109	m	MSA13, PPE, CFG13
4E	78	N	MTA14		6E	110	n	MSA14, PPE, CFG14
4F	79	O	MTA15		6F	111	o	MSA15, PPE, CFG15
50	80	P	MTA16		70	112	p	MSA16, PPD
51	81	Q	MTA17		71	113	q	MSA17, PPD
52	82	R	MTA18		72	114	r	MSA18, PPD
53	83	S	MTA19		73	115	s	MSA19, PPD
54	84	T	MTA20		74	116	t	MSA20, PPD
55	85	U	MTA21		75	117	u	MSA21, PPD

Hex	Dec	ASCII	Message		Hex	Dec	ASCII	Message
56	86	V	MTA22		76	118	v	MSA22, PPD
57	87	W	MTA23		77	119	w	MSA23, PPD
58	88	X	MTA24		78	120	x	MSA24, PPD
59	89	Y	MTA25		79	121	y	MSA25, PPD
5A	90	Z	MTA26		7A	122	z	MSA26, PPD
5B	91	[MTA27		7B	123	{	MSA27, PPD
5C	92	\	MTA28		7C	124		MSA28, PPD
5D	93]	MTA29		7D	125	}	MSA29, PPD
5E	94	^	MTA30		7E	126	~	MSA30, PPD
5F	95	_	UNT		7F	127	DEL	—

Multiline Interface Message Definitions			
CFE *	Configuration Enable	PPD	Parallel Poll Disable
CFG *	Configure	PPE	Parallel Poll Enable
DCL	Device Clear	PPU	Parallel Poll Unconfigure
GET	Group Execute Trigger	SDC	Selected Device Clear
GTL	Go To Local	SPD	Serial Poll Disable
LLO	Local Lockout	SPE	Serial Poll Enable
MLA	My Listen Address	TCT	Take Control
MSA	My Secondary Address	UNL	Unlisten
MTA	My Talk Address	UNT	Untalk
PPC	Parallel Poll Configure		
* This multiline interface message is a proposed extension to the IEEE 488 specification to support the HS488 protocol.			

Product Certifications and Declarations

Refer to the product Declaration of Conformity (DoC) for additional regulatory compliance information. To obtain product certifications and the DoC for NI products, visit ni.com/product-certifications, search by model number, and click the appropriate link.

NI Services

Visit ni.com/support to find support resources including documentation, downloads, and troubleshooting and application development self-help such as tutorials and examples.

Visit ni.com/services to learn about NI service offerings such as calibration options, repair, and replacement.

Visit ni.com/register to register your NI product. Product registration facilitates technical support and ensures that you receive important information updates from NI.

NI corporate headquarters is located at 11500 N Mopac Expwy, Austin, TX, 78759-3504, USA.