

COMPREHENSIVE SERVICES

We offer competitive repair and calibration services, as well as easily accessible documentation and free downloadable resources.

SELL YOUR SURPLUS

We buy new, used, decommissioned, and surplus parts from every NI series. We work out the best solution to suit your individual needs.

 Sell For Cash  Get Credit  Receive a Trade-In Deal

OBSOLETE NI HARDWARE IN STOCK & READY TO SHIP

We stock **New**, **New Surplus**, **Refurbished**, and **Reconditioned** NI Hardware.



Bridging the gap between the manufacturer and your legacy test system.

 1-800-915-6216

 www.apexwaves.com

 sales@apexwaves.com

All trademarks, brands, and brand names are the property of their respective owners.

Request a Quote

 **CLICK HERE**

IC-3121

PRODUCT FLYER

Industrial Controllers

CONTENTS

[Industrial Controllers](#)

[Detailed View of Industrial Controllers](#)

[Key Features](#)

[Integrated Software](#)

[Vision Software](#)

[Hardware Services](#)

Industrial Controllers

IC-3120, IC-3121, IC-3171, IC-3172, and IC-3173



- Processor—Up to 2.2 GHz 5th Gen Intel Core i7 dual-core processor, 8 GB DDR3 RAM, 64 GB storage
- FPGA—Up to Kintex-7 160T for custom I/O timing, synchronization, control, and image processing
- Open connectivity so you can use the camera vendor of your choice
- Rugged, fanless design with up to 0 °C to 55 °C operating temperature
- Up to 4 GigE PoE, 2 USB 3.0, 4 USB 2.0, 2 DisplayPort, 1 RS232/RS485, and 1 network port
- OS—Windows Embedded Standard 7 and NI Linux Real-Time

The Perfect Combination of Ruggedness and Performance

NI Industrial Controllers are high-performance, fanless devices that offer the highest level of processing power and connectivity for automated image processing, data acquisition, and control applications in extreme environments. These controllers feature up to a 2.2 GHz Intel Core i7 dual-core processor, 8 GB DDR3 RAM, 64 GB storage in a rugged design with no moving parts, and an IP rating up to IP67. A Kintex-7 FPGA improves system performance by providing custom I/O timing, synchronization, control, and image co-processing.

NI Industrial Controllers give you the ideal connectivity for communication and synchronization to Time Sensitive Networking (TSN)-enabled CompactDAQ chassis, EtherCAT and Ethernet CompactRIO chassis, EtherCAT motion drives, GigE Vision and USB3 Vision cameras, and other automation equipment. In addition, this controller has onboard ISO, TTL, and differential digital I/O, so it can perform synchronization and control tasks without additional tethered I/O.

These controllers can run either Windows Embedded Standard 7 (WES7) or NI Linux Real-Time, so you can choose the familiarity of a Windows user interface or the reliability of a real-time OS. The NI Linux Real-Time OS gives you access to the Linux community's massive software ecosystem. The embedded user interface capability of NI Linux Real-Time enables the implementation of a local human machine interface to simplify your application development.

You can use LabVIEW system design software to create, debug, and deploy logic to NI Industrial Controllers through hundreds of prewritten libraries for analysis, control, logging, motion, and image processing. With these validated software libraries, you can reduce the time you spend piecing together software components from different vendors and troubleshooting compatibility issues.

Table 1. NI Industrial Controller Specifications

	IC-3120	IC-3121	IC-3171	IC-3172	IC-3173
Processor	1.9 GHz Quad-Core Intel Atom	1.9 GHz Quad-Core Intel Atom	1.9 GHz Dual-Core Intel Celeron	1.8 GHz Dual-Core Intel i5	2.2 GHz Dual-Core Intel i7
OS	WES 7 or NI Linux Real-Time	WES 7 or NI Linux Real-Time	WES 7 or NI Linux Real-Time	NI Linux Real-Time	WES 7 or NI Linux Real-Time
RAM Size	4 GB	4 GB	4 GB	8 GB	8 GB
Onboard Storage	Up to 32 GB	Up to 32 GB	Up to 32 GB	4 GB	Up to 64 GB
FPGA	Spartan-6 LX25	Spartan-6 LX25	Kintex-7 160T	Kintex-7 160T	Kintex-7 160T
Industrial I/O	8 ISO In, 8 ISO Out, 8 TTL, 2 DIFF QE	8 ISO In, 8 ISO Out, 8 TTL, 2 DIFF QE	8 ISO In, 8 ISO Out, 8 TTL, 2 DIFF QE	8 ISO In, 8 ISO Out, 8 TTL, 2 DIFF QE	8 ISO In, 8 ISO Out, 8 TTL, 2 DIFF QE
Camera Interface	GigE Vision	USB3 Vision	GigE Vision, USB3 Vision	GigE Vision, USB3 Vision	GigE Vision, USB3 Vision
GigE PoE Ports	2	--	4	4	4
USB 3.0 Ports	--	2	2	2	2
USB 2.0 Ports	1	1	4	4	Up to 4
IEEE 1588	Software Timed	Software Timed	Hardware Timed	Hardware Timed	Hardware Timed
Power	10.8 to 26.4 V DC	10.8 to 26.4 V DC	9 to 30 V DC	9 to 30 V DC	9 to 30 V DC
Temperature Range	0 °C to 55 °C	0 °C to 55 °C	0 °C to 55 °C	0 °C to 55 °C	0 °C to 55 °C (IP20) 0 °C to 45 °C (IP67)
Display	VGA	VGA	DisplayPort (x2)	DisplayPort (x2)	DisplayPort (x2)
IP Rating	IP40	IP40	IP20	IP20	IP20/IP67
Size	10.8 cm × 6.1 cm × 13.0 cm	10.8 cm × 6.1 cm × 13.0 cm	17.4 cm × 9.3 cm × 16.8 cm	17.4 cm × 9.3 cm × 16.8 cm	17.4 cm × 9.3 cm × 16.8 cm (IP20) 32.1 cm × 9.3 cm × 19.3 cm (IP67)

Detailed Views of Industrial Controllers

IC-3120

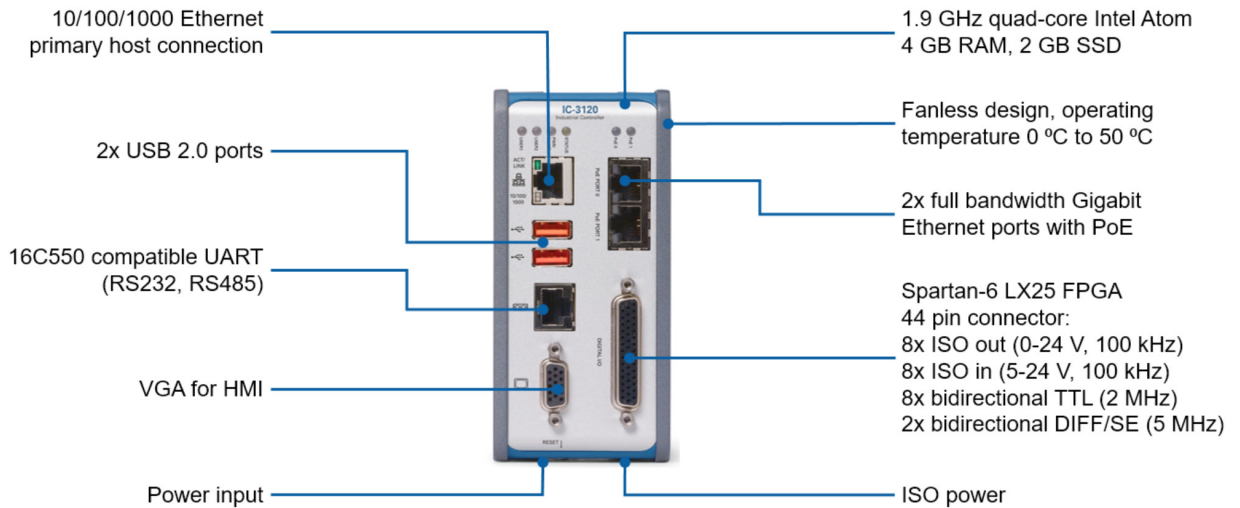

IC-3121

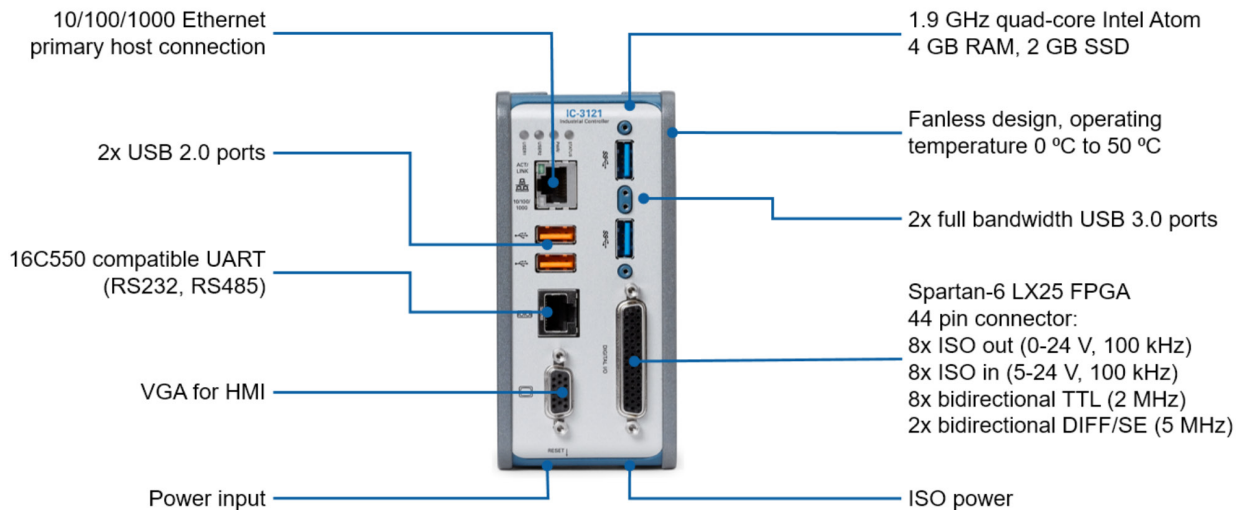

IC-3173

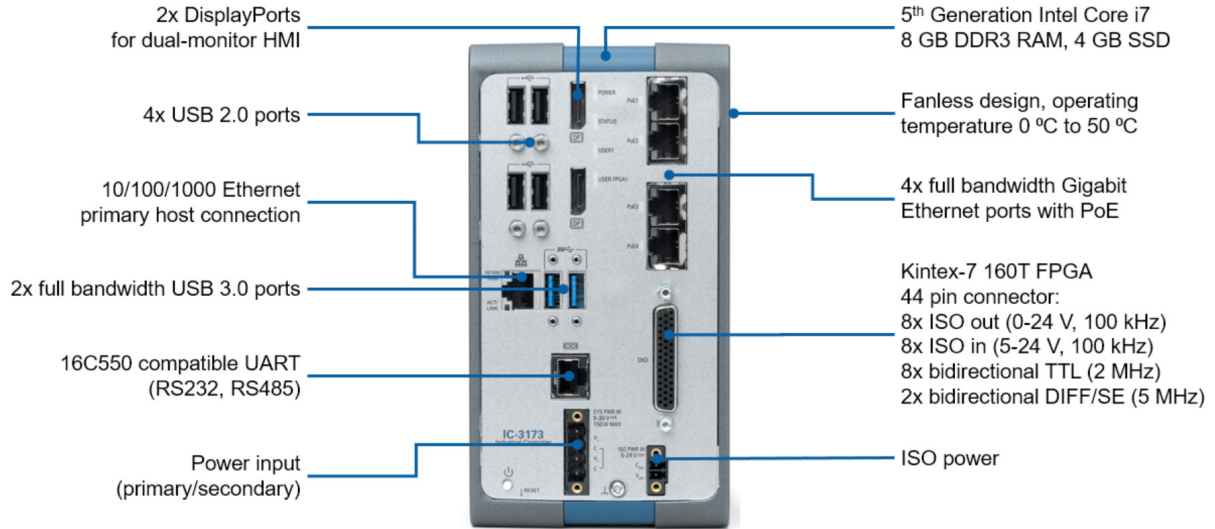

IC-3173 (IP67)

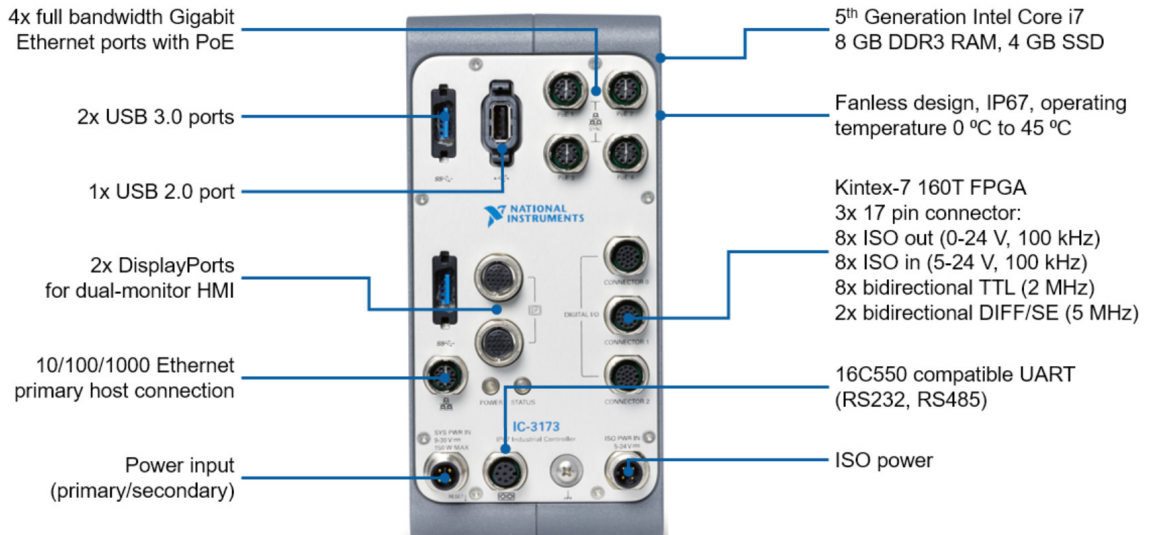

Key Features

Performance

NI has strong relationships with key technology providers like Intel and Xilinx. For example, NI is an associate member of the Intel Embedded Alliance, which offers access to the latest Intel product roadmaps and samples. These relationships allow the company to integrate the latest technology into their products shortly after they release, which provides a performance edge in the industry.

Unlike many industrial controllers on the market today, NI Industrial Controllers feature a heterogeneous processing architecture that contains two processing units: (1) a processor running Windows or a real-time OS for communication and signal processing and (2) an FPGA for use as a co-processor that implements high-speed control and custom timing and triggering directly in the hardware.

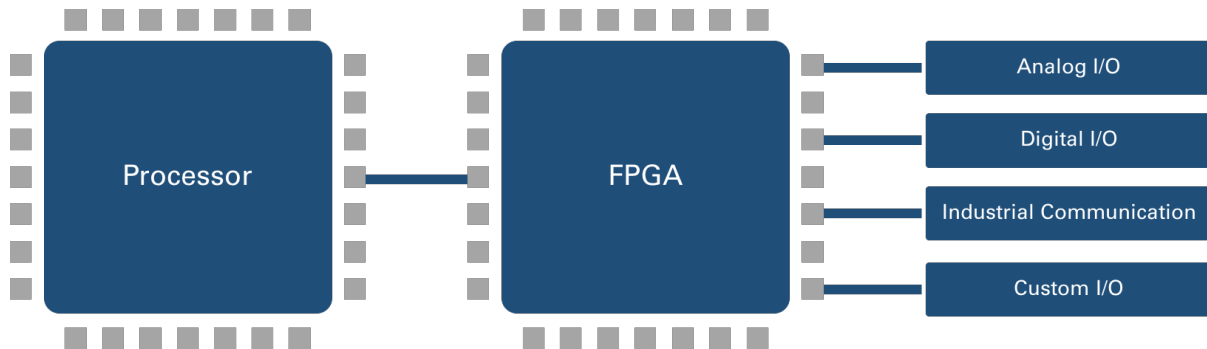

Figure 1. Use the heterogeneous architecture of the Industrial Controller to meet your processing needs.

Processor

NI Industrial Controllers contain up to a 2.2 GHz dual-core Intel Core i7 high-performance processor with lower power consumption in an industrial form factor.

FPGA

The onboard FPGA options include Xilinx Spartan-6 LX25 or Kintex-7 160T. Though you can use either FPGA for tasks such as high-speed control and custom timing and triggering, the Kintex-7 is the ideal choice for co-processing, especially for image processing applications.

Table 2. Xilinx FPGA Specifications

FPGA	Flip-Flops	6-Input LUTs	DSP48 Slices	Embedded Block RAM (kb)
Spartan-6 LX25	30,064	15,032	38	936
Kintex-7 160T	202,800	101,400	600	11,700

FPGA Co-Processing

In an FPGA co-processing architecture, the FPGA and CPU work together to share the processing load. This architecture is most commonly used with GigE Vision and USB3 Vision cameras because their acquisition logic is best implemented using a CPU. After acquiring the image using the CPU, you send the image to the FPGA via DMA so the FPGA can perform operations such as filtering or color plane extraction. Then you can send the image back to the CPU for more advanced operations such as optical character recognition (OCR) or pattern matching. In some cases, you can perform all the processing

steps on the FPGA, and only the processing results are sent back to the CPU. This allows the CPU to devote more resources to other operations such as motion control, network communication, and image display.

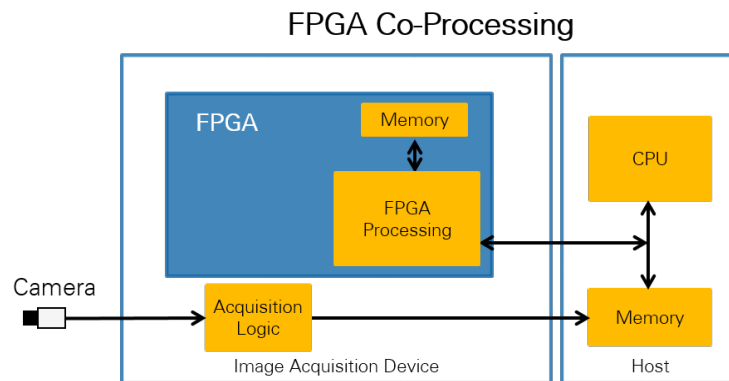

Figure 2. In FPGA co-processing, you acquire images using the CPU and then send them to the FPGA via DMA so the FPGA can perform operations.

Using the FPGA as a co-processor for machine vision applications can significantly decrease the processing time for a particular algorithm. Because FPGAs are massively parallel in nature, they can offer significant performance improvements, in some cases more than 10X, over CPUs for certain algorithms.

Optimized for Machine Vision

NI Industrial Controllers can be used in a wide variety of applications ranging from data acquisition to control. However, the connectivity options and the unique design make them especially useful in machine vision applications. These controllers support the GigE Vision and USB3 Vision standard, so you can choose the compliant camera of your choice.

GigE Vision

NI Industrial Controllers feature up to four PoE ports per controller, each with dedicated bandwidth. If you require more than four GigE Vision cameras, you can use a hub to connect additional cameras with shared bandwidth.

USB3 Vision

In addition to GigE Vision ports, NI Industrial Controllers feature up to two dedicated bandwidth USB 3.0 ports for connecting USB3 Vision cameras. Furthermore, NI is one of the few vendors that offer cable retention on USB 3.0 ports, which increases the reliability of the connection in industrial environments.

FPGA-Enabled I/O

NI Industrial Controllers give developers the ability to use the onboard FPGA for more powerful I/O. The controllers include a prebuilt FPGA personality called Vision RIO, which is a turnkey IP set that allows you to take advantage of FPGA-enabled I/O without ever having to program the FPGA. Vision RIO allows you to configure a queue of pulses, set line states, and enable hardware-timed IEEE 1588, so, without FPGA programming knowledge, you can achieve a reliable, hardware-timed method of synchronizing I/O with visually inspected parts. Using the Vision RIO API, you can configure several different scenarios, including triggered acquisition with multiple encoder- and proximity-controlled ejectors, and manage ejectors controlled with PLC-issued timestamps.

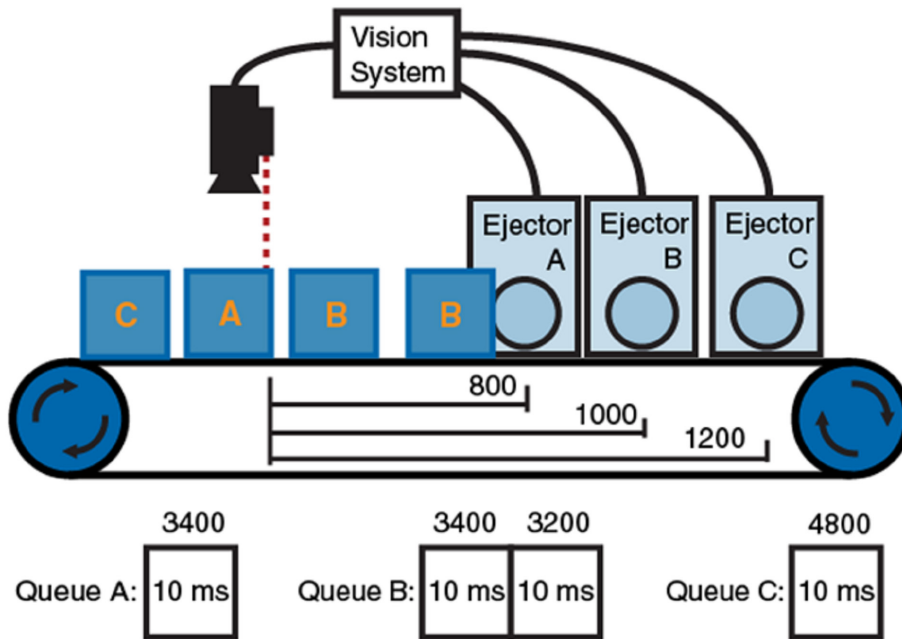

Figure 3. This triggered acquisition example features multiple encoder-controlled ejectors.

Beyond the Vision RIO API, you can also take advantage of the LabVIEW FPGA Module to develop custom, application-specific IP to meet your unique application needs.

Advanced Synchronization

NI Industrial Controllers offer advanced synchronization capabilities. With support for both hardware-timed IEEE 1588 Precision Time Protocol (PTP) and Time Sensitive Networking, Industrial Controllers are ideal for a wide range of industrial and machine vision applications.

Hardware-Timed IEEE 1588 PTP

IEEE 1588 is a synchronization protocol implemented over Ethernet networks. It allows for many nodes on a network to synchronize their clocks with a high level of accuracy. The protocol defines a “Best Master Clock” algorithm for which each master periodically messages to synchronize the slave nodes’ time with the master’s.

Synchronization accuracy depends on the jitter associated with the clock’s timestamp. When the timestamping is implemented in software, systems can achieve submillisecond synchronization. When the timestamping is implemented in hardware, specifically in NI’s IC-317x Industrial Controllers, systems can achieve submicrosecond synchronization.

12-hour Software 1588 and Hardware 1588 Offset Comparison

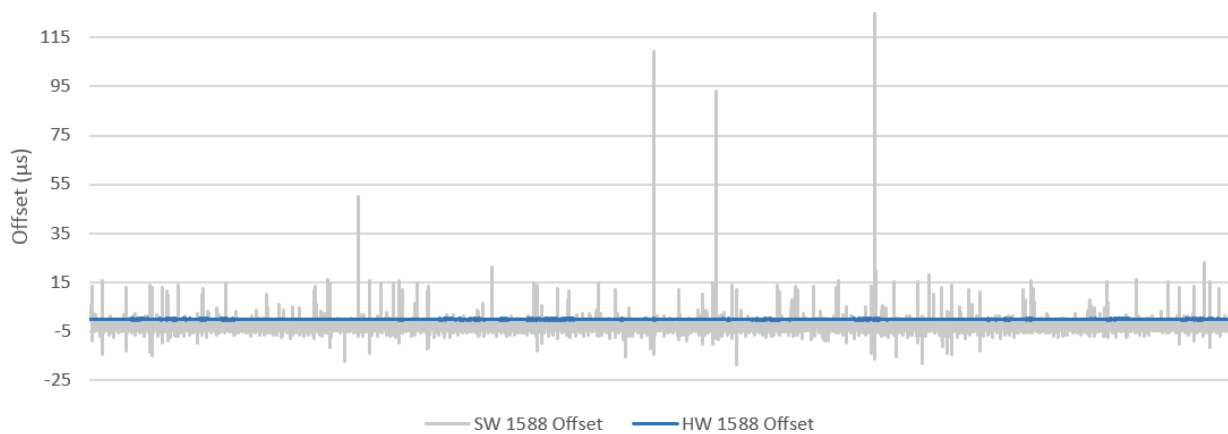

Figure 4. Software-timed synchronization versus hardware-timed synchronization using IEEE 1588 PTP

IC-317x Industrial Controllers take IEEE 1588 synchronization a step further by allowing the onboard user-programmable FPGA's timebase to be steered to the IEEE 1588 master clock (see Figure 5). With this architecture, you can synchronize custom I/O on the FPGA to the master clock. This is useful to synchronize system components that may not have IEEE 1588 support such as a PLC or USB3 Vision camera.

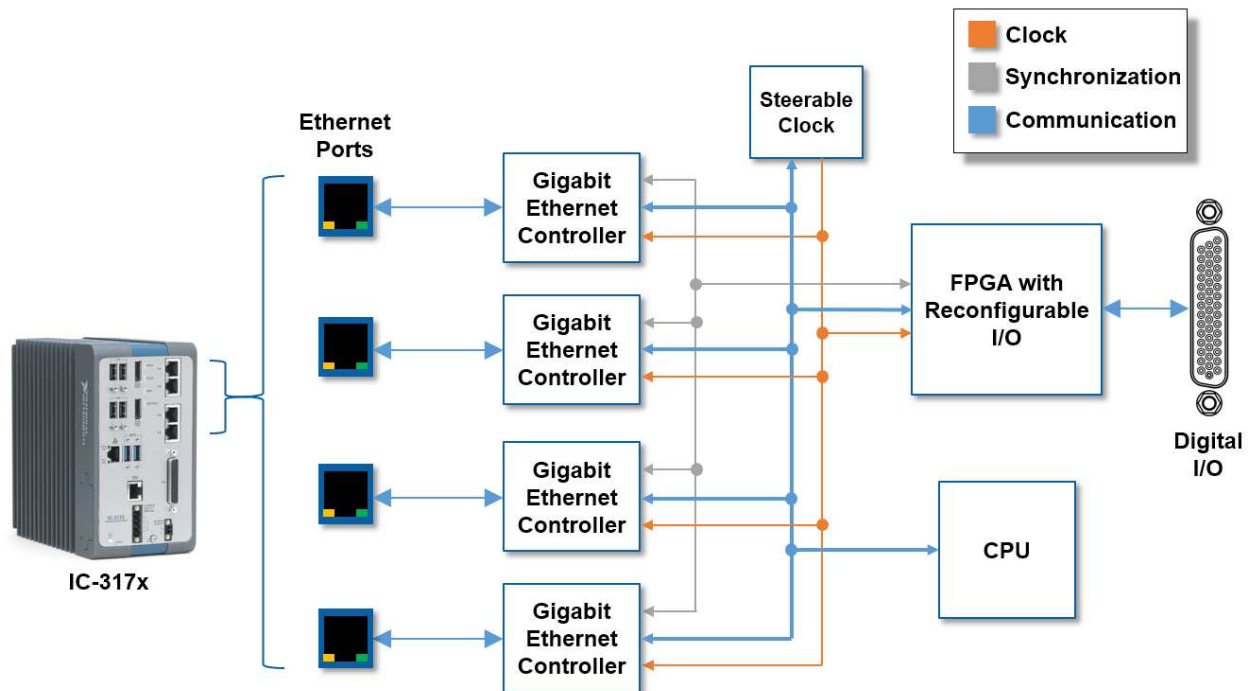

Figure 5. The FPGA is synchronized to the IEEE 1588 master clock in IC-317x Industrial Controllers.

Finally, IC-317x Industrial Controllers support IEEE 802.1AS and IEEE 1588; they can act as bridges between fully Time Sensitive Networks and more traditional IEEE 1588 networks. This ability to synchronize devices across multiple technologies provides maximum system flexibility.

Time Sensitive Networking

Time Sensitive Networking (TSN) is the evolution of standard Ethernet to include time-based synchronization, traffic scheduling, and system configuration. Traffic scheduling and system configuration enable deterministic communication over Ethernet by allowing you to schedule time-critical data across a network.

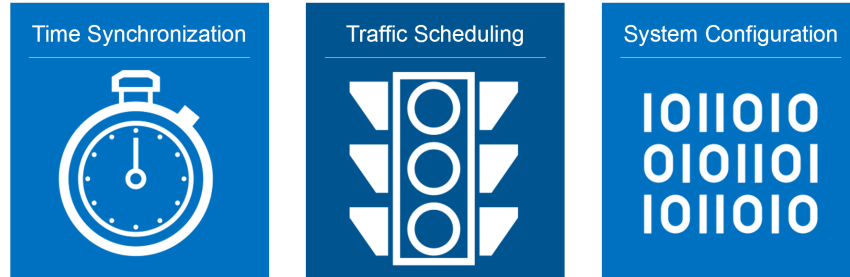

Figure 6. Three key IEEE 802.1 projects being added to standard Ethernet

TSN is a key enhancement for industrial applications such as process and machine control. They need low communication latency and minimal jitter to meet their closed-loop control requirements. With the ability to schedule traffic across an Ethernet network via system configuration software, you can reliably send both deterministic data and best effort data across a shared Ethernet cable. Time-based synchronization over Ethernet also minimizes the cabling traditionally found in physical systems test and monitoring applications, which leads to a cleaner and more cost-effective solution. Together with several other Industrial Internet Consortium (IIC) members, NI has been hard at work to bring TSN to life as the first fully open, standard, and interoperable way to fulfill these requirements.

Take advantage of TSN today with three TSN-enabled NI products: CompactRIO Controller with TSN, Ethernet CompactDAQ Chassis with TSN, and the Industrial Controller with TSN. Find these TSN-enabled products by looking for the Synchronization attribute in the online Shop.

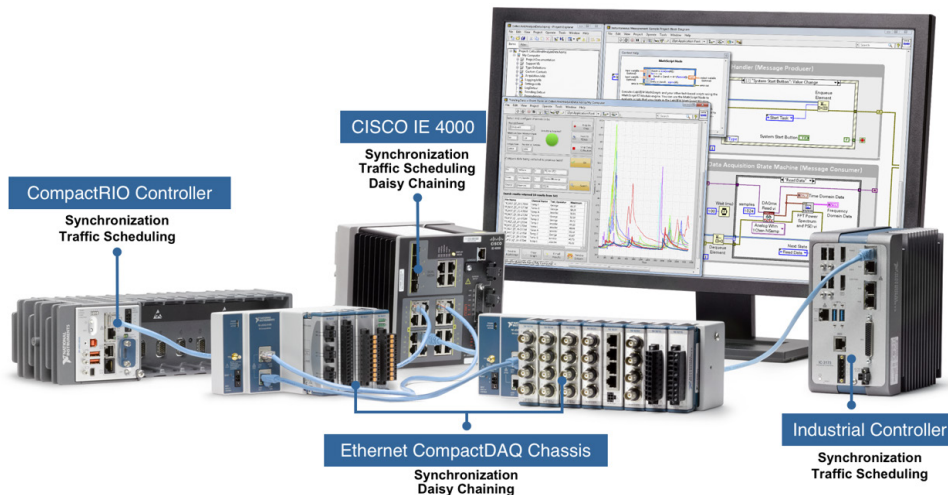

Figure 7. TSN-enabled NI products

Ruggedness

NI Industrial Controllers are designed, tested, and validated according to stringent design practices to ensure reliable operation in harsh industrial environments. These controllers can meet demanding requirements for performance, operating temperature, ingress protection, and vibration while delivering unrivaled control and data acquisition capabilities in a compact, rugged package. They feature an operating temperature range of up to 0 °C to 50 °C, 50 g shock and 5 g vibration ratings, ingress protection up to IP67, redundant power supply inputs, and a variety of international safety, HazLoc, and environmental certifications and ratings for operation in harsh industrial environments.

Integrated Software

You can define—and redefine—the functionality of your Industrial Controller with intuitive software and use a single toolchain for every phase of your design cycle, from modeling and simulation to prototyping and validation to deployment and beyond. NI software reduces risk, enhances productivity, and eliminates the need to create and maintain I/O drivers, operating systems, and other middleware.

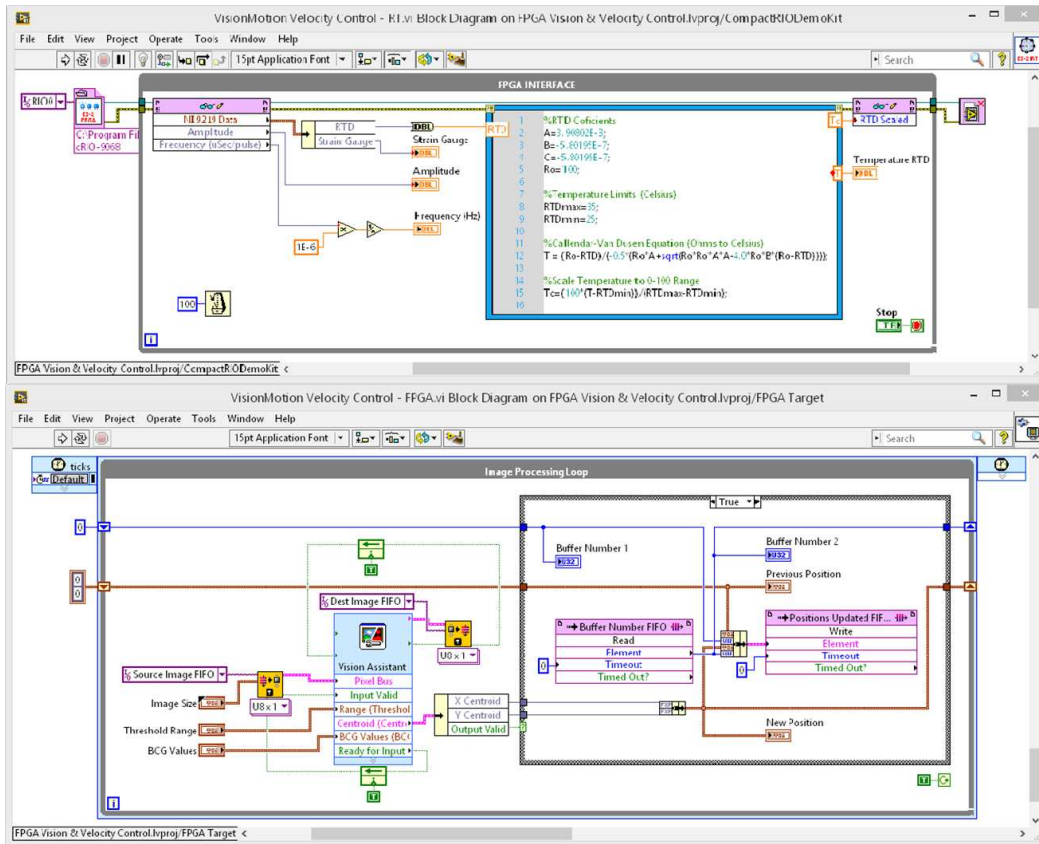

Figure 8. Intuitive and cohesive software programming environment

Reduced Development Time

Focus on solving problems, not low-level programming tasks, with built-in constructs to manage timing and memory in an intuitive programming environment.

Open Software Interoperability

Leverage other programming approaches alongside or within LabVIEW to reuse IP and take advantage of existing expertise.

Built-In Libraries

Use the over 950 LabVIEW built-in signal processing, analysis, control, and mathematics functions to develop embedded control and monitoring systems faster.

User-Programmable FPGA

Implement high-speed signal and image processing, custom timing and triggering, and control algorithms directly in hardware to maximize reliability and determinism.

Remote System Management

Transfer data between systems or remotely update hundreds of controllers at once with built-in system management utilities.

LabVIEW Tools Network

Extend the capabilities of your system with a vast ecosystem of certified, application-specific add-ons.

Leverage the Openness of NI Linux Real-Time: A Prebuilt, Validated RTOS

Development Tool Options

Program the real-time processor with LabVIEW, C/C++, or textual math and reuse code from past projects to save development time.

Linux Ecosystem

Access thousands of open-source applications, IP, and examples and collaborate with an active community of users and developers.

Security

Boost security and reliability with native support for Security-Enhanced Linux, which delivers mandatory access control through custom policy creation.

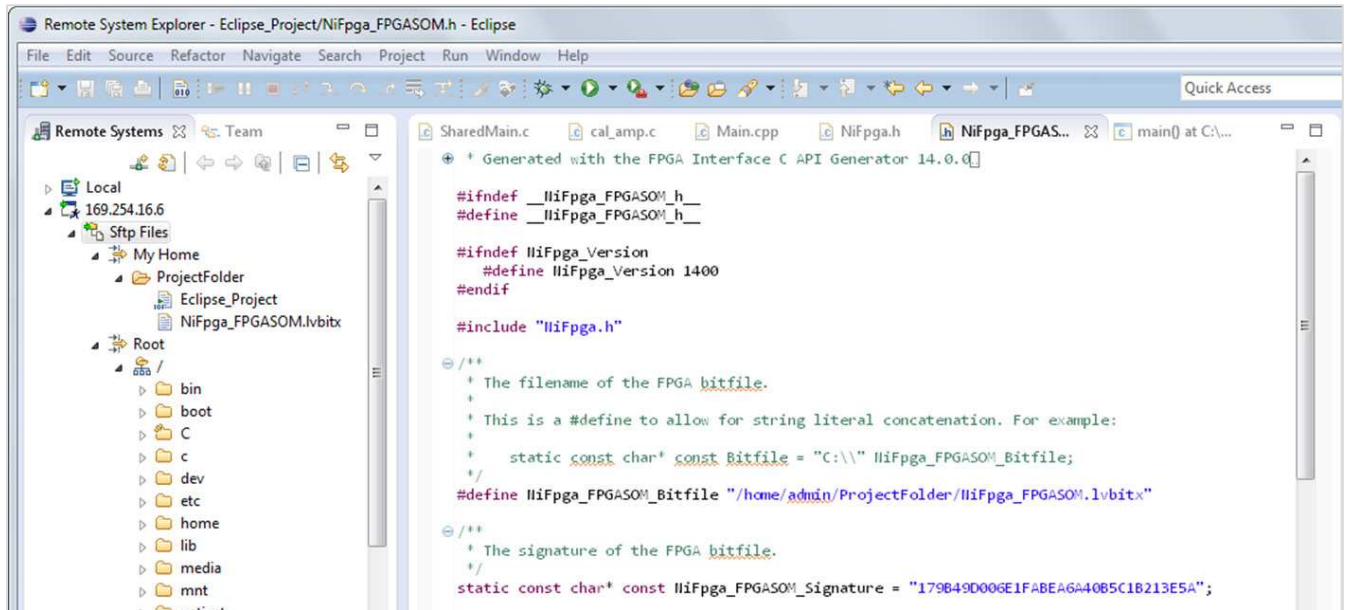

Figure 9. NI Linux Real-Time targets allow you to develop, deploy, and debug C/C++ code using Eclipse or your IDE of choice.

Customize Programmable Hardware With LabVIEW FPGA

Take advantage of the graphical LabVIEW environment to program the onboard FPGA and unlock the incredible power of these devices even without any knowledge of hardware description languages like VHDL or Verilog. The LabVIEW FPGA Module not only removes the requirement for HDL programming but also eliminates the need to think through timing constraints, I/O configuration, and place and route settings, which are notoriously complex tasks.

- Built-in language constructs to manage clocks/timing, memory, I/O, and data transfer (DMA)
- Cycle-accurate simulation and debugging capabilities
- Support for HDL code integration
- Cloud compile support to reduce compile times
- Access to free IP for complex mathematics, high-speed control, image processing, signal analysis, and more in the FPGA IPNet community

Vision Software

Vision Builder for Automated Inspection

Vision Builder for Automated Inspection (AI) is a stand-alone configurable software environment that you can use to easily build, benchmark, and deploy applications for pattern matching, character recognition, presence detection, part classification, and more. Vision Builder AI offers an interactive menu-driven development environment replaces the complexities of programming, making the development and maintenance process simple without sacrificing performance or range of functionality.

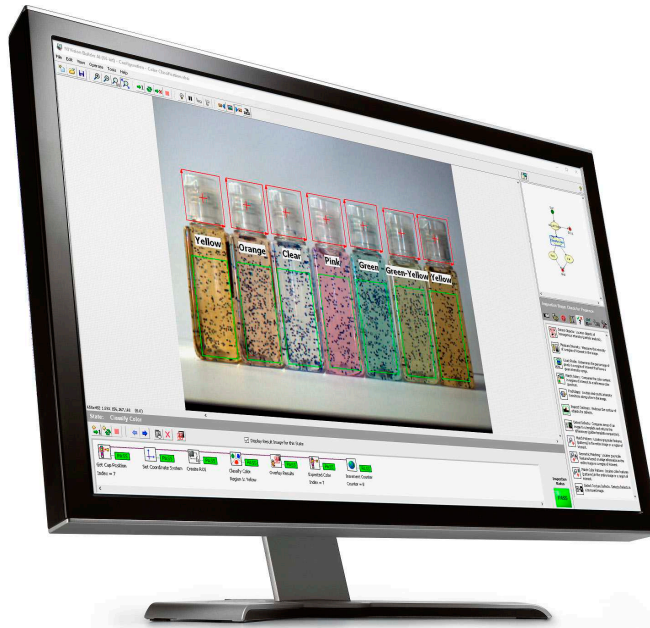

Figure 10. Simplify development with a sophisticated environment.

Vision Builder AI offers several different features, including:

Faster Development and Deployment – Vision Builder AI allows you to develop powerful machine vision applications. Using the menu-driven environment, you can focus on algorithm development instead of programming.

Advanced Decision Making – With the built-in State Diagram Editor, digital I/O, and industrial communications, you can deploy your Vision Builder AI application into the rest of your automated system.

Fully Tested Toolchain – The scalability of Vision Acquisition Software coupled with third-party camera support provides an open and fully tested infrastructure that saves time and money.

Saved Development Time – Use real data to develop your algorithms. Import or acquire test images directly into Vision Builder AI.

Customizable Algorithms – See the results of each function in your algorithm and tweak your algorithm each step of the way.

Built-In Productivity Tools – Develop algorithms faster with tools for template generation, OCR training, pattern matching, and more.

Vision Development Module

The Vision Development Module offers hundreds of image processing algorithms and acquisition functions that you can use across the entire NI vision hardware portfolio to meet any vision application need. For more advanced imaging applications, the Vision Development Module is the ideal software package. With its comprehensive function library, you can access hundreds of image processing algorithms and machine vision functions to enhance images, check for presence, locate features, identify objects, measure parts, and more. The Vision Development Module offers the most flexibility and low-level function control for developing vision application solutions.



Figure 11. Build highly customized applications with systems in mind.

The Vision Development Module offers several different features, including:

Build High-Performance Solutions – Use hundreds of functions to develop high-performance vision algorithms to run on CPUs and FPGAs.

Choose Your Programming Language – Program your application in LabVIEW, LabWindows™/CVI, and C/C++.

Design Complete Systems – Expand your application beyond just vision. Incorporate motion control, I/O, and HMI's in your design.

Massive Parallelism – FPGAs are parallel in nature, so they are ideally suited for vision applications. Parallelizing your algorithm decreases processing time, reduces latency, and increases overall throughput.

Infinite Customizability – FPGA-based image processing is implemented pixel by pixel, giving you the opportunity to customize your algorithm to meet your exact requirements.

No FPGA Experience Needed – You can develop high-performance FPGA-based vision algorithms the same way you do for a CPU-based design. You do not need to know traditional FPGA design tools.

Vision Assistant

One of the challenges of developing software for machine vision applications is that vision algorithm development is, by its very nature, an iterative process requires multiple iterations of testing, adjusting function parameters and retesting until the software satisfies the application requirements. This can be especially troublesome with using FPGAs for image processing as the traditional approach to FPGA development can slow down innovation due to the compilation times required between each design change of the algorithm. To address this challenge, the Vision Development Module also includes a tool called the Vision Assistant.

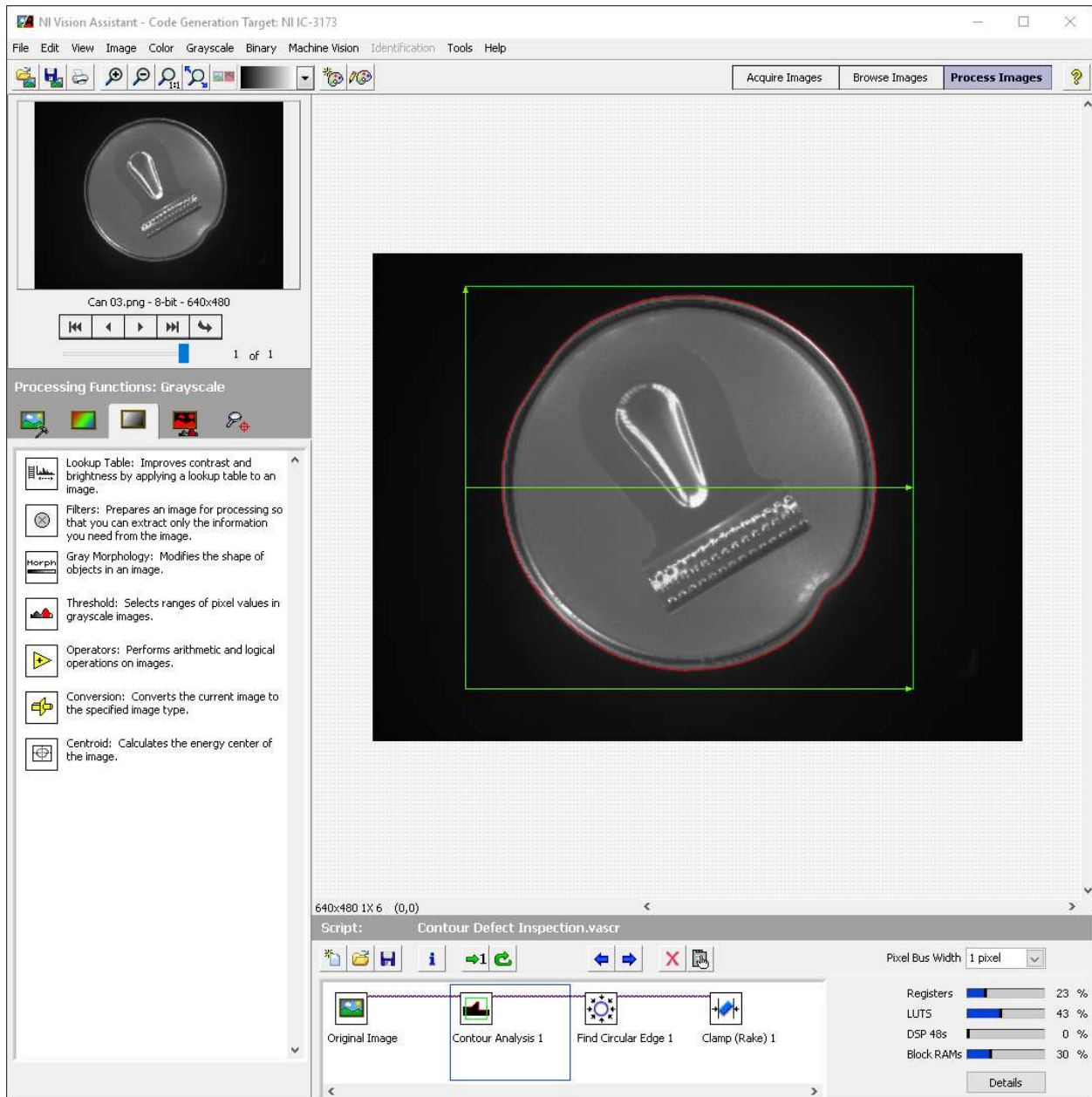

Figure 12. Developing an algorithm in a configuration-based tool for FPGA targets with integrated benchmarking cuts down on the time spent waiting for code to compile and accelerates development.

The NI Vision Assistant is an algorithm engineering tool that simplifies vision system design by helping designers develop algorithms for deployment on either the CPU or FPGA. The Vision Assistant provides a configuration based approach to building vision algorithms, like Vision Builder AI. Load or acquire sample images and see the results of each processing step as it is configured so that you rapidly prototype your machine vision algorithm. It also provides the necessary benchmarking tools to gauge the performance of the algorithm. Finally, the Vision Assistant can also be used to test the algorithm before compiling and running it on the target hardware while easily accessing throughput and resource utilization information.

Once users are satisfied with their algorithm, the Vision Assistant can be used to generate LabVIEW or C code ready for deployment on the hardware controller of their choice. Here users can easily modify the generated code to integrate it with other parts of your system.

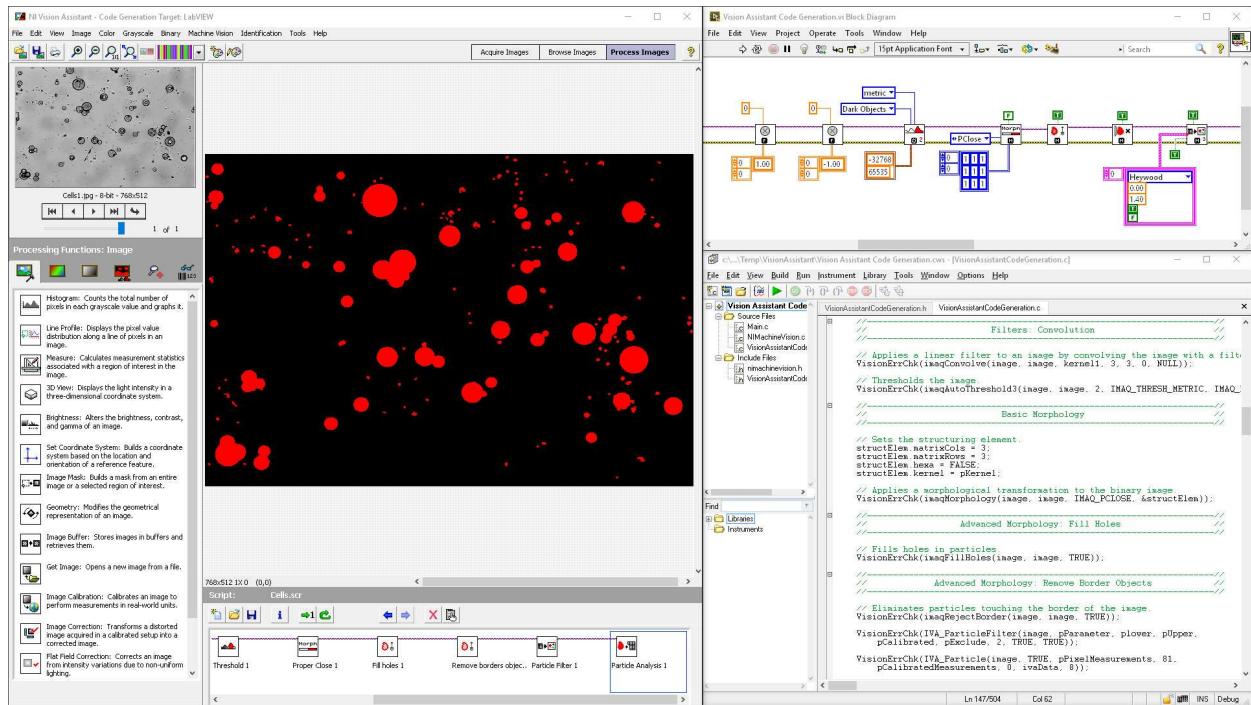

Figure 13. Use Vision Assistant to generate LabVIEW or C code.

Hardware Services

All NI hardware includes a one-year warranty for basic repair coverage, and calibration in adherence to NI specifications prior to shipment. PXI systems also include basic assembly and a functional test. NI offers additional entitlements to improve uptime and lower maintenance costs with service programs for hardware. Learn more at ni.com/services/hardware.

	Standard	Premium	Description
Program Duration	1, 3, or 5 years	1, 3, or 5 years	Length of service program
Extended Repair Coverage	•	•	NI restores your device's functionality and includes firmware updates and factory calibration.
System Configuration, Assembly, and Test ¹	•	•	NI technicians assemble, install software in, and test your system per your custom configuration prior to shipment.
Advanced Replacement ²		•	NI stocks replacement hardware that can be shipped immediately if a repair is needed.
System Return Material Authorization (RMA) ¹		•	NI accepts the delivery of fully assembled systems when performing repair services.
Calibration Plan (Optional)	Standard	Expedited ³	NI performs the requested level of calibration at the specified calibration interval for the duration of the service program.

¹This option is only available for PXI, CompactRIO, and CompactDAQ systems.

²This option is not available for all products in all countries. Contact your local NI sales engineer to confirm availability.

³Expedited calibration only includes traceable levels.

PremiumPlus Service Program

NI can customize the offerings listed above, or offer additional entitlements such as on-site calibration, custom sparring, and life-cycle services through a PremiumPlus Service Program. Contact your NI sales representative to learn more.

Technical Support

Every NI system includes a 30-day trial for phone and e-mail support from NI engineers, which can be extended through a [Software Service Program \(SSP\)](#) membership. NI has more than 400 support engineers available around the globe to provide local support in more than 30 languages. Additionally, take advantage of NI's award winning [online resources](#) and [communities](#).

©2017 National Instruments. All rights reserved. CompactRIO, CVI, LabVIEW, National Instruments, NI, ni.com, and NI CompactDAQ are trademarks of National Instruments. The mark LabWindows is used under a license from Microsoft Corporation. Windows is a registered trademark of Microsoft Corporation in the United States and other countries. Other product and company names listed are trademarks or trade names of their respective companies. The registered trademark Linux® is used pursuant to a sublicense from LMI, the exclusive licensee of Linus Torvalds, owner of the mark on a worldwide basis. National Instruments Alliance Partner is a business entity independent from National Instruments and has no agency, partnership, or joint-venture relationship with National Instruments.