

## COMPREHENSIVE SERVICES

We offer competitive repair and calibration services, as well as easily accessible documentation and free downloadable resources.

## SELL YOUR SURPLUS

We buy new, used, decommissioned, and surplus parts from every NI series. We work out the best solution to suit your individual needs.

 Sell For Cash    Get Credit    Receive a Trade-In Deal

## OBSOLETE NI HARDWARE IN STOCK & READY TO SHIP

We stock **New**, **New Surplus**, **Refurbished**, and **Reconditioned** NI Hardware.



*Bridging the gap between the manufacturer and your legacy test system.*

 1-800-915-6216

 [www.apexwaves.com](http://www.apexwaves.com)

 [sales@apexwaves.com](mailto:sales@apexwaves.com)

*All trademarks, brands, and brand names are the property of their respective owners.*

**Request a Quote**

 **CLICK HERE**

**NI-9144**

# GETTING STARTED

# NI SMD-7611/7612 Stepper Drives and NI 9512 C Series Modules



**Note** If you are a new user of LabVIEW or are unfamiliar with LabVIEW, refer to the *Getting Started with LabVIEW* manual for information about LabVIEW and LabVIEW terminology.

This document explains how to install and configure the NI SMD-7611/7612 stepper drives for use with the NI 9512 C Series drive interface module.

## Contents

---

What You Need to Get Started .....	2
Hardware .....	2
Software .....	3
Hardware Installation and Configuration .....	4
Step 1: Set Up the Real Time System.....	4
Step 2: Connect the NI 9512 to the 37-Pin Terminal Block.....	4
Step 3: Connect the 37-Pin Terminal Block to the +24 V Power Supply .....	5
Step 4: Connect the Drive Command Signals .....	6
Step 5: Connect the Drive Enable Signal .....	6
Step 6: (Optional) Connect the Drive Fault Signal.....	7
Step 7: (Optional) Connect the Encoder Signals .....	7
Step 8: Connect the NI PS-12/13 Power Supply to the NI SMD-7611/7612.....	8
Step 9: Connect the SMD-7611/7612 to the Motor.....	9
Step 10: Configure the NI SMD-7611/7612 DIP Switches.....	10
Step 11: Set the Motor Selection Switch .....	11
Step 12: Power on the Drive and Verify Connections.....	14
Software Installation and Configuration.....	14
Step 1: Install Software on and Configure the NI RT Controller.....	14
Step 2: Create a Project and add NI RT Controller .....	15
A. CompactRIO Controller.....	15
B. EtherCAT Master and NI 9144 EtherCAT Expansion Chassis .....	16
C. NI 9146/7/8/9 Ethernet RIO Expansion Chassis .....	17
Step 3: Add a SoftMotion Axis to the Project.....	17
Step 4: Configure the NI 9512 Axis .....	19
Step 5: Enable and Test the Drive Using LabVIEW .....	22
Where To Go From Here.....	23
Worldwide Support and Services .....	24

# What You Need to Get Started

---

You need the following items to get started.

## Hardware

- NI 9512 C Series stepper drive interface module
- NI Real-Time controller
  - CompactRIO controller and chassis that support the RIO Scan Interface.



**Tip** To determine if your controller and chassis support the RIO Scan Interface go to [ni.com/info](http://ni.com/info) and enter the Info Code `rdsoftwareversion`.

or

- NI 9146, 9147, 9148, or 9149 Ethernet RIO Expansion Chassis.

or

- NI 9144 distributed chassis and compatible RT controller.

- +24 V power supply (such as the NI PS-15) for the CompactRIO controller (NI part number 781093-01)
- Separate +24 V power supply for the NI 9512 (such as the NI PS-15)
- NI PS-12 or NI PS-13 power supply for the NI SMD-7611/7612
- NI SMD-7611/7612 stepper drive
- NI or third-party stepper motor



**Note** NI offers stepper motors matched to the NI SMD-7611/7612. Refer to [ni.com/motion](http://ni.com/motion) for motor options. National Instruments highly recommends using these motors for the best user experience.

- (Optional) ENC-7740 encoder for ST17 motors (NI part number 748991-01) or ENC-7741 encoder for ST23 motors (NI part number 748992-01)
- Encoder Cable to connect the encoder to the NI 951x terminal block (NI part number 783661-10)
- Ethernet connection and cable for the CompactRIO controller
- NI 951x Cable and Terminal Block bundle (NI part number 780553-01)

# Software

- LabVIEW 2010 (minimum).
- LabVIEW 2010 Real-Time Module (minimum).
- LabVIEW 2010 NI SoftMotion Module (minimum).
- NI-RIO 3.5.1 (minimum).

Figure 1 shows a simplified connection diagram.

**Figure 1. NI 9512 to NI SMD-7611/7612 Connections**

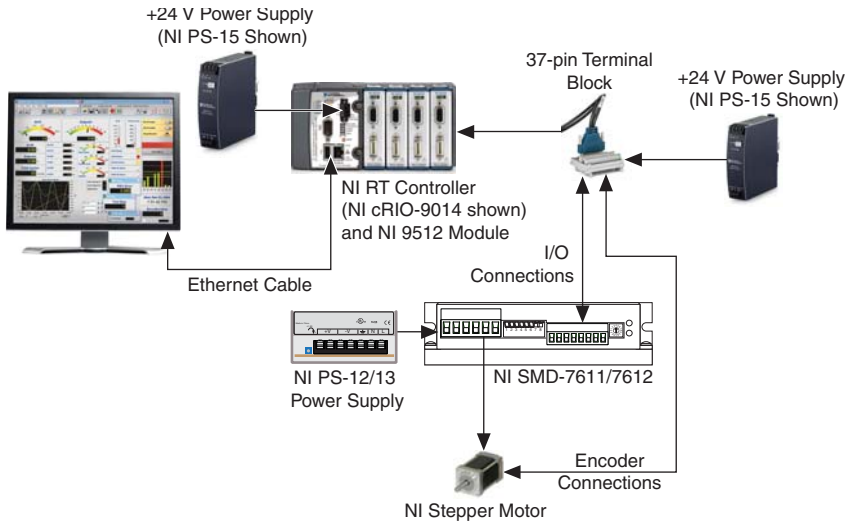

# Hardware Installation and Configuration

---

This section covers the hardware setup for the Real Time system, NI 9512 C Series module, and NI SMD-7611/7612 stepper drive.

## Step 1: Set Up the Real Time System

Complete the following steps to set up the Real Time system depending on your hardware.

1. Refer to the Getting Started guide included with the Real-Time controller to assemble it, connect it to power, discover it on the network, and install the software in NI MAX.
2. Install the NI 9512 module in an available slot that supports High Speed Interface (HSI) in your chassis.



**Note** Older model chassis, such as cRIO-902x, cRIO-907x, cRIO-908x, NI 9144, and NI 9148, have HSI support on slots 1 through 4. Refer to your chassis documentation for more information about HSI slot support.

## Step 2: Connect the NI 9512 to the 37-Pin Terminal Block

1. Connect the MDR and DSUB connectors on the NI 951x Y-cable to the MDR and DSUB connectors on the NI 9512 module.
2. Connect the 37-pin DSUB to the DSUB connector on the NI 951x terminal block.

Figure 2 shows the 37-pin terminal block pin assignments.

**Figure 2. NI 9512 37-Pin Terminal Block Pin Assignments**

Forward Limit					Digital Output 1 <sup>†</sup>
Home					Reverse Limit
COM					Reserved
Digital Input 0					V <sub>sup</sub>
COM					Reserved
Encoder 0 Index+					COM
Encoder 0 Index-					Encoder 0 Phase A+
COM					Encoder 0 Phase A-
+5V OUT					Encoder 0 Phase B+
Position Compare					Position Capture
Reserved					Encoder 0 Phase B-
Reserved					Reserved
Digital Output 0 <sup>†</sup>					Reserved
V <sub>sup</sub> <sup>†</sup>					COM <sup>†</sup>
Digital Input 1 <sup>†</sup>					Drive Enable <sup>†</sup>
Direction (CCW)+ <sup>†</sup>					Digital Input 3 <sup>†</sup>
COM <sup>†</sup>					Direction (CCW)- <sup>†</sup>
Step (CW)+ <sup>†</sup>					Digital Input 2 <sup>†</sup>
Shield					Step (CW)- <sup>†</sup>

<sup>†</sup> Indicates DSUB connector signals.

## Step 3: Connect the 37-Pin Terminal Block to the +24 V Power Supply



**Note** Do not plug in or turn on the power supply until after you complete [Step 12: Power on the Drive and Verify Connections](#).

1. Connect the V+ terminal from the 24 V power supply to one of the two V<sub>sup</sub> inputs on the 37-pin terminal block. The 37-pin terminal block provides a V<sub>sup</sub> input for the NI 9512 on pin 14 and pin 22.
2. Connect the V- terminal from the 24 V power supply to one of the COM terminals on the 37-pin terminal block. The 37-pin terminal block provides COM on pins 3, 5, 8, 17, 24, and 32.

## Step 4: Connect the Drive Command Signals

Complete the following steps to connect the Drive Command signals to the NI 9512 terminal block.

1. Connect the SMD-7611/7612 STEP+ and DIR+ terminals to the 37-pin terminal block +5V OUT terminal (pin 9).
2. Connect the SMD-7611/7612 STEP- terminal to the 37-pin terminal block Step (CW)+ terminal (pin 18).
3. Connect the SMD-7611/7612 DIR- terminal to the 37-pin terminal block Direction (CCW)+ terminal (pin 16).

Figure 3 shows the SMD-7611/7612 Drive Command and I/O Connector location and pinout.

**Figure 3.** SMD-7611/7612 Drive Command and I/O Connector

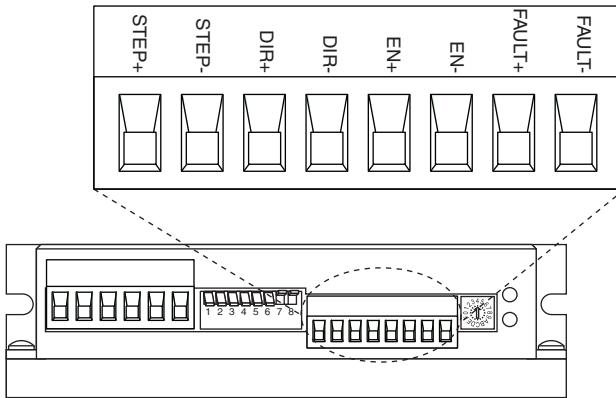

## Step 5: Connect the Drive Enable Signal

Complete the following steps to connect the Drive Enable signal, which controls the enable function of the drive:

1. Connect the EN- terminal to the 37-pin terminal block COM terminal (pin 5).
2. Connect the EN+ terminal to the 37-pin terminal block Drive Enable terminal (pin 33).

## Step 6: (Optional) Connect the Drive Fault Signal

Complete the following steps to map an NI 9512 digital input to the SMD-7611/7612 fault output signal to monitor the NI SMD-7611/7612 stepper drive for faults:

1. Connect the FAULT+ terminal to the 37-pin terminal block Vsup terminal (pin 22).
2. Connect the FAULT- terminal to the 37-pin terminal block DI 0 terminal (pin 4).

## Step 7: (Optional) Connect the Encoder Signals

If your motor includes an encoder, complete the following steps to connect the encoder to the NI 951x terminal block:

1. If an NI Encoder is being used, connect the appropriate end of the encoder cable (NI part number 783661-10) to the encoder.
2. Connect the encoder wires to the 37-pin terminal block as indicated in Table 1.
3. Insulate any unused wires.

**Table 1.** NI SMD-7611/7612 to 37-Pin Terminal Block Connections

Encoder Signal Name	Encoder Cable Wire Color	37-Pin Terminal Block Pin Number	37-Pin Terminal Block Signal Name
CH A	blue	25	Encoder 0 Phase A+
CH A-	blue/white	26	Encoder 0 Phase A-
CH B	yellow	27	Encoder 0 Phase B+
CH B-	yellow/white	29	Encoder 0 Phase B-
INDEX	orange	6	Encoder 0 Index+
INDEX-	orange/white	7	Encoder 0 Index-
GND	black	8	COM
+Vcc	red	9	+5V OUT



# Step 8: Connect the NI PS-12/13 Power Supply to the NI SMD-7611/7612



**Note** Do not plug in or turn on the power supply until after you complete [Step 12: Power on the Drive and Verify Connections](#).

Complete the following steps to connect the power supply to AC input power and to the NI SMD-7611/7612. Figure 4 shows the power supply terminals.

**Figure 4.** NI PS-12/13 Power Supply Terminals

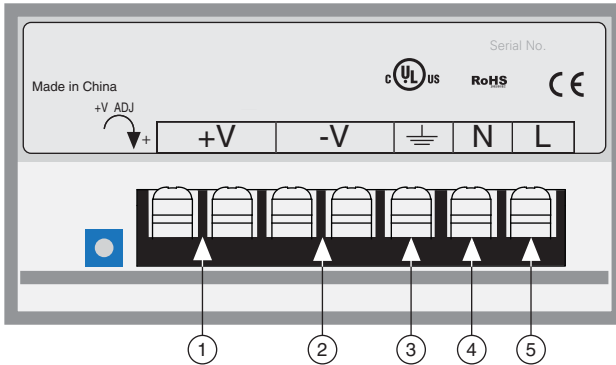

- |   |                    |
|---|--------------------|
| 1 +24 V (NI PS-12) or +48 V (NI PS-13) Output | 4 AC Input Neutral |
| 2 +24 V (NI PS-12) or +48 V (NI PS-13) Ground | 5 AC Input Line    |
| 3 AC Input Ground (Protective Earth)          |                    |

Figure 5 shows the SMD-7611/7612 Power and Motor Connector location and pinout.

**Figure 5.** SMD-7611/7612 Power and Motor Connector

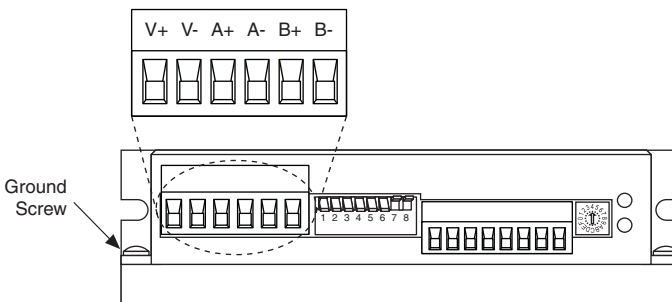

1. Connect an AC input cable to the line, neutral, and protective earth connectors.
2. Connect the SMD-7611/7612 V+ terminal to the power supply +V connector.
3. Connect the SMD-7611/7612 V- terminal to the power supply -V connector.

4. Connect the SMD-7611/7612 green ground screw to earth ground.
5. Connect the NI 9512 COM to the NI PS-12/13 -V terminal to ensure a common reference.



**Note** Refer to the *NI SMD-7611/7612 User Manual* for more information about connecting the power supply.

## Step 9: Connect the SMD-7611/7612 to the Motor

NI offers stepper motors matched to the SMD-7611/7612. The ST24-1, ST24-2, and ST24-3 are four lead motors. Connect them as shown in Figure 6.

**Figure 6. Four Lead Motor Connection**

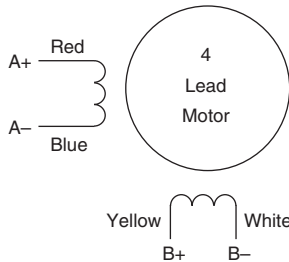

The ST17-1, ST17-2, ST17-3, ST17-4, ST23-1, ST23-4, ST23-6, ST23-8, ST34-4, ST34-8 are eight lead motors that are connected using a parallel configuration. Connect them as shown in Figure 7.

**Figure 7. Eight Lead Motor Parallel Connection**

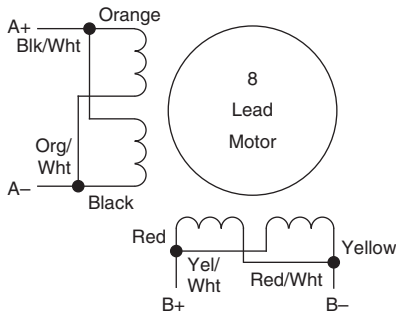

When using the SMD-7612, connect the ST34-1, ST34-2, and ST34-5 using a parallel configuration as shown in Figure 7.

When using the SMD-7611, connect the ST34-1, ST34-2, and ST34-5 using a series configuration as shown in Figure 8.

**Figure 8.** Eight Lead Motor Series Connection

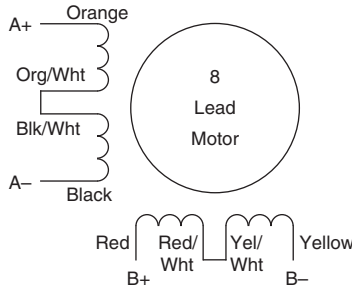

## Step 10: Configure the NI SMD-7611/7612 DIP Switches

The NI SMD-7611/7612 provides drive configuration DIP switches. Refer to the *NI SMD-7611/7612 User Manual* for more information about the DIP switch options. The following figure shows the DIP switch location and functions.





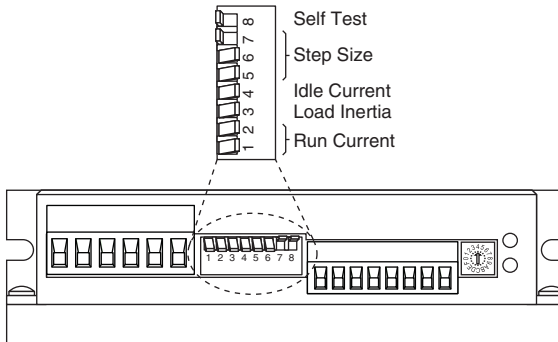

**Note** If you change the DIP switch settings you must power cycle the NI SMD-7611/7612 for the new settings to take effect.

**Figure 9.** NI SMD-7611/7612 DIP Switches

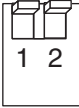
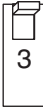

Refer to Table 2 for the DIP switch settings that this document uses.

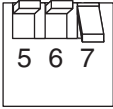
**Table 2. DIP Switch Settings**

Setting Name	Switch Position	Corresponding Value
Running Current		100%
Load Inertia		0 - 4X
Idle Current		50%
Steps/rev		2000
Self Test		Off

## Step 11: Set the Motor Selection Switch

National Instruments offers stepper motors matched to the NI SMD-7611/7612. National Instruments highly recommends using these motors for the best user experience. Figure 10 shows the Motor Selection Switch location.

**Figure 10. NI SMD-7611/7612 Motor Selection Switch**

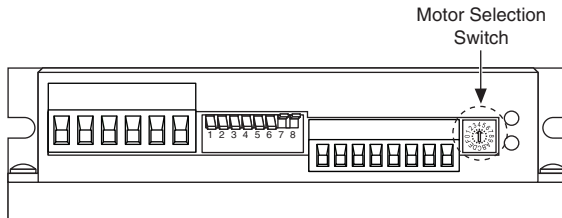

Tables 3 and 4 show the switch settings for compatible stepper motors for the SMD-7611 and SMD-7612, respectively. If you are using a motor not in the list, set the switch to a motor with a rotor inertia, holding torque, and current that are within 10% of your motor.

**Table 3.** NI SMD-7611 Motor Selection Switch Settings

Switch Setting	Motor	Wiring	Drive Current Amps, peak of sine	Holding Torque, (oz-in)	Rotor Inertia (g-cm <sup>2</sup> )
0	reserved for custom configurations				
1					
2	ST17-4	parallel	2.4	113	123
3	ST17-1	parallel	1.6	31.4	35
4	ST17-2	parallel	2	51	54
5	ST17-3	parallel	2	62.8	68
6	ST23-1	parallel	3.4	76.6	120
7	ST23-4	parallel	4.5	159.3	300
8	ST23-6	parallel	4.5	237.6	480
9	ST24-1	4 leads	3.36	123	280
A	ST24-2	4 leads	4.5	166	450
B	ST24-3	4 leads	4.5	332	900
C	ST34-2	series	4.5	585	1400
D	ST34-5	series	4.5	1113	2680
E	ST34-1	series	3.816	396	1100

**Table 4.** NI SMD-7612 Motor Selection Switch Settings

Switch Setting	Motor	Wiring	Drive Current Amps, peak of sine	Holding Torque, oz-in	Rotor Inertia g-cm <sup>2</sup>
0	reserved for custom configurations				
1					
2					
3	ST23-8	parallel	6	354	750
4	ST23-1	parallel	3.4	76.6	120
5	ST23-4	parallel	5	177	300
6	ST23-6	parallel	5	264	480
7	ST24-1	4 leads	3.36	123	280
8	ST24-2	4 leads	4.8	177	450
9	ST24-3	4 leads	4.8	354	900
A	ST34-2	parallel	8	507	1400
B	ST34-5	parallel	8	965	2680
C	ST34-8	parallel	8	1439	4000
D	ST34-1	parallel	7.56	396	1100
E	ST34-4	parallel	7.56	849	1850

# Step 12: Power on the Drive and Verify Connections

After all hardware connections have been made complete the following steps to confirm the hardware setup.

1. Turn on all power supplies.
2. Verify that the Drive Status LED on the NI SMD-7611/7612 flashes or is solid green. Figure 11 shows the location of the Drive Status LED.

**Figure 11.** Drive Status LED Location

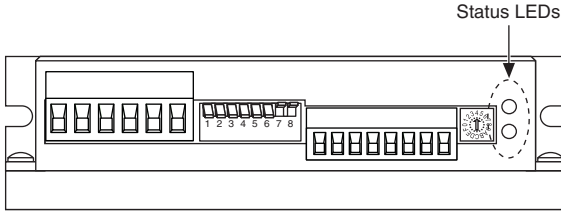

If the Drive Status LED does not flash or turn solid green, turn off all power, verify the connections, and try again. Refer to the [Worldwide Support and Services](#) section for additional tips.

## Software Installation and Configuration

This section covers installing and configuring software for the NI 9512 C Series module.



**Note** These instructions assume you have installed all required software from the [What You Need to Get Started](#) section on your development machine.

### Step 1: Install Software on and Configure the NI RT Controller

Complete the following steps to configure the controller and install software on it.

1. Launch Measurement & Automation Explorer (MAX) on the development computer by clicking the MAX icon on the desktop, or by selecting **Start»All Programs»National Instruments»NI MAX**.
2. Select the controller under **Remote Systems** in the **Configuration** pane. If you do not see the controller, you may need to disable the firewall on the development computer.
3. Verify that the **Serial Number** in the **Identification** section matches the serial number on the device.
4. Expand the controller item in the tree, right-click **Software**, and select **Add/Remove Software**.
5. Select a recommended software set that includes NI-RIO 3.5.1 (minimum) with NI Scan Engine Support.

6. Click **Next** and enable the following add-ons:
  - LabVIEW SoftMotion Module
  - NI Industrial Communications for EtherCAT if using the NI 9144.
7. Click **Next** to install the selected software on the controller. Click **Help** if you need information about installing recommended software sets.
8. Close MAX.

## Step 2: Create a Project and add NI RT Controller

Complete the following steps to create a LabVIEW project.

1. Launch LabVIEW by selecting **Start»All Programs»National Instruments»LabVIEW**.
2. Click the **Empty Project** link in the **Getting Started** window to display the **Project Explorer** window. You can also select **File»New Project** to display the **Project Explorer** window.
3. Select **Help** and make sure that **Show Context Help** is checked. You can refer to the context help throughout the tutorial for information about items on the block diagram.

Depending on the hardware configuration being used, continue to the following respective sections.

### A. CompactRIO Controller

If you are using a CompactRIO controller, complete the following steps to add the device to the project and detect the C Series modules.

1. Right-click the top-level project item in the **Project Explorer** window and select **New»Targets and Devices** from the shortcut menu to display the **Add Targets and Devices** dialog box.
2. Make sure that the **Existing target or device** radio button is selected.
3. Expand **Real-Time CompactRIO**.
4. Select the CompactRIO controller to add to the project and click **OK**.
5. If you have LabVIEW FPGA installed, the **Select Programming Mode** dialog box appears. Select **Scan Interface** to put the system into Scan Interface mode.



**Tip** Use the **CompactRIO Chassis Properties** dialog box to change the programming mode in an existing project. Right-click the CompactRIO chassis in the **Project Explorer** window and select **Properties** from the shortcut menu to display this dialog box.

6. Click **Discover** in the **Discover C Series Modules?** dialog box if it appears.
7. Click **Continue**.
8. Right-click the controller item in the **Project Explorer** window and select **Properties** from the shortcut menu to display the **RT Target Properties** dialog box. Select **Scan Engine** from the **Category** list to display the Scan Engine page.



9. Set the **Scan Period** to 5 ms or lower.
10. Click **OK** to close the **RT Target Properties** dialog box.

## B. EtherCAT Master and NI 9144 EtherCAT Expansion Chassis

If you are using the NI 9144 chassis, complete the following steps to add the EtherCAT master device and detect the C Series module.

1. Add the Master Real Time Controller to the project. Right click the top level project item in the **Project Explorer** window and select **New»Targets and Devices** from the shortcut menu to display the **Add Targets and Devices** dialog box.
2. Make sure that **Existing target or device** radio button is selected.
3. Expand the folder that corresponds to the device you are adding, such as Real Time Industrial Controller, Real Time PXI, and so on.
4. Select Real Time to add to the project and click **OK**.
5. In the LabVIEW **Project Explorer** window, right-click the master controller and select **New»Targets and Devices**.
6. In the **Add Targets and Devices** dialog window shown in Figure 12, select **Existing target or device** and expand the category EtherCAT Master Device to auto-discover the EtherCAT port on the master controller. An EtherCAT master device and modules can be added manually at any time.

**Figure 12.** Adding the EtherCAT Master

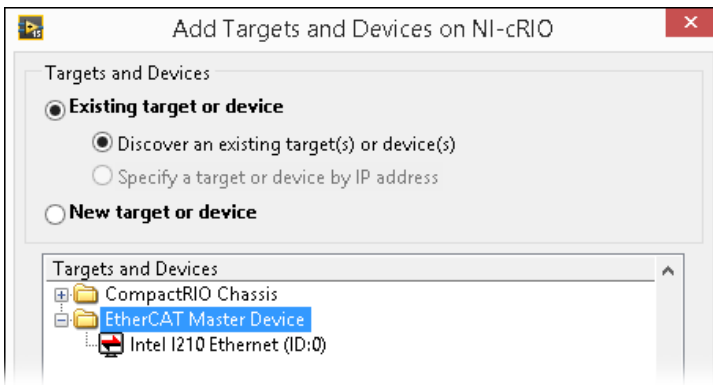

When all the slave devices are discovered, the LabVIEW **Project Explorer** window lists each slave device and any installed C Series modules.

## C. NI 9146/7/8/9 Ethernet RIO Expansion Chassis

Complete the following steps to add the device to the project and detect the C Series modules if the NI 9146/7/8/9 Ethernet RIO Expansion chassis is being used.

1. Right-click the top-level project item in the **Project Explorer** window and select **New» Targets and Devices** from the shortcut menu to display the **Add Targets and Devices** dialog box.
2. Make sure that the **Existing target or device** radio button is selected.
3. Expand **Ethernet RIO**.
4. Select the Ethernet RIO expansion chassis to add to the project and click **OK**.
5. If you have LabVIEW FPGA installed, the **Select Programming Mode** dialog box appears. Select **Scan Interface** to put the system into Scan Interface mode.



**Tip** Use the **Chassis Properties** dialog box to change the programming mode in an existing project. Right-click the chassis in the **Project Explorer** window and select **Properties** from the shortcut menu to display this dialog box.

6. Click **Discover** in the **Discover C Series Modules?** dialog box if it appears.
7. Click **Continue**.
8. Right-click the controller item in the **Project Explorer** window and select **Properties** from the shortcut menu to display the **Ethernet RIO Properties** dialog box. Select **Scan Engine** from the **Category** list to display the Scan Engine page.
9. Set the **Scan Period** to 5 ms or lower.
10. Click **OK** to close the **Ethernet RIO Properties** dialog box.

## Step 3: Add a SoftMotion Axis to the Project

Complete the following steps to create a LabVIEW project and add a SoftMotion Axis to it.

1. Right-click the controller item in the **Project Explorer** window and select **New» NI SoftMotion Axis** from the shortcut menu to open the **Axis Manager** dialog box, shown in Figure 7.
2. Click **Add New Axis** to create an NI SoftMotion axis associated with the NI 9512 module. Axes are automatically bound to an available module. You can double-click the axis name to rename the axis and give it a descriptive name.

**Figure 13.** Axis Manager Dialog Box

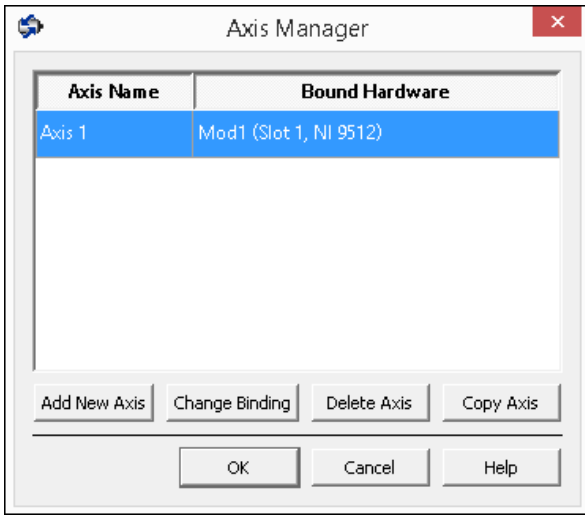

3. Click **OK** to close the **Axis Manager** dialog box. The new axis is added to the **Project Explorer** window.



**Note** You cannot associate more than one axis with the same C Series module.

When you have finished these steps your LabVIEW project should look similar to the image in Figure 14.

**Figure 14.** Project Explorer Window with Modules in Scan Interface Mode

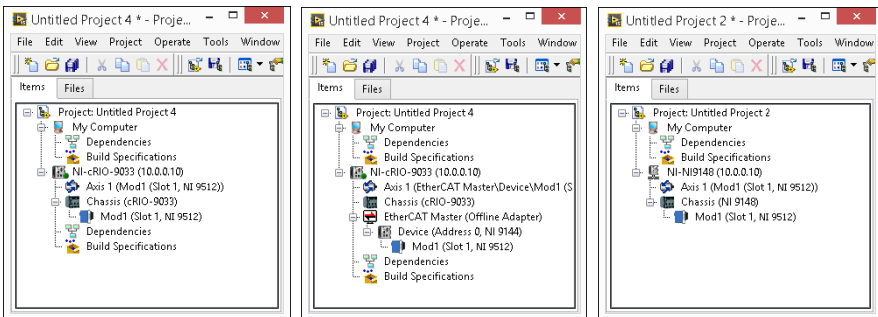

# Step 4: Configure the NI 9512 Axis

The **Axis Configuration** dialog box includes configuration options for stepper drive command signals, feedback devices, motion and digital I/O, trajectory, and axis setup. Figure 15 shows the parts of the **Axis Configuration** dialog box for the NI 9512 C Series module. Refer to the *NI SoftMotion Module* book of the *LabVIEW Help* for detailed information about each configuration option.

**Figure 15.** Axis Configuration Dialog Box

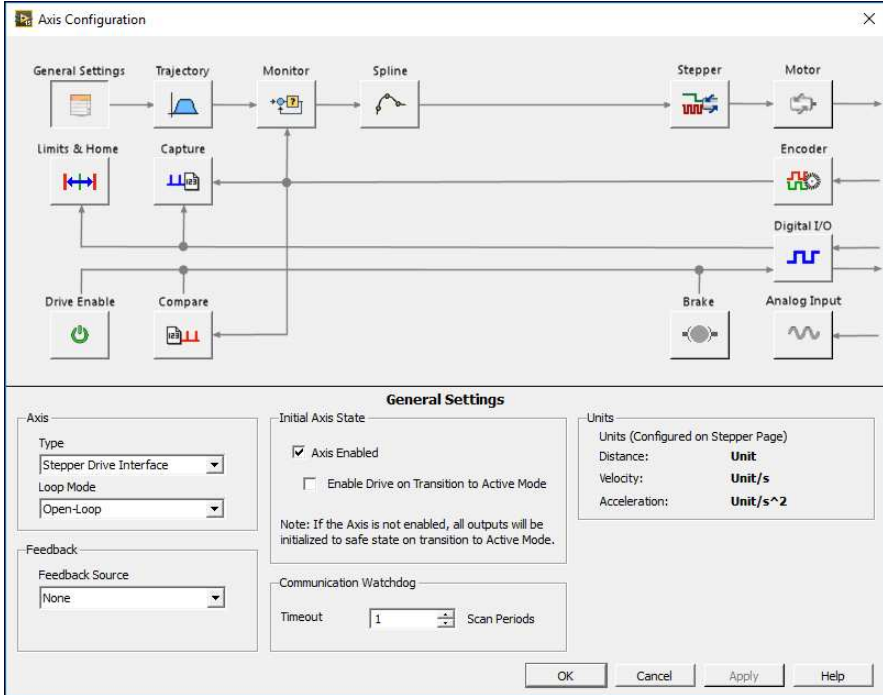

**Note** The **Axis Configuration** dialog box user interface may not match this image exactly depending on which version of the LabVIEW NI SoftMotion Module you are using.

Complete the following steps to configure the axis I/O settings for use with the NI SMD-7611/7612 stepper drive.

1. Right-click the axis in the **Project Explorer** window and select **Properties** from the shortcut menu to open the **Axis Configuration** dialog box.
2. Configure the following settings on the **General Settings** page (  ).
  - a. Confirm that **Loop Mode** is set to **Open-Loop**. Axes configured in open-loop mode produce step outputs but do not require feedback from the motor to verify position.
  - b. Set **Feedback Source** to **Encoder 0**, if you have connected an encoder, or **None** if you do not have an encoder connected.
  - c. Confirm that the **Axis Enabled** and **Enable Drive on Transition to Active Mode** checkboxes contain checkmarks. These selections configure the axes to automatically activate when the NI Scan Engine switches to Active mode.



**Note** Disable these options to prevent axes from automatically activating when the NI Scan Engine switches to Active mode.

3. If you have connected an encoder, click the Encoder button (  ) and configure the Units and Counts Per Unit.
  - a. In the **Active State** section set the **Line State** for **A**, **B**, and **Index** to **High**.
  - b. In the **Index Reference Criteria** section set the **Line State** for **A** and **B** to **Inactive**.
  - c. Select **rev** from the **Units** text box, or type **revolutions** if you prefer.
  - d. Set the **Counts per rev** to 8,000. This setting is the encoder resolution in quadrature counts per revolution and corresponds to the encoder lines per revolution multiplied by four.



**Note** The counts per revolution should be set accordingly if a dual shaft motor with a third party Encoder is being used.

When you are finished the Encoder Settings page will look similar to Figure 16.

**Figure 16.** Axis Configuration Encoder Page

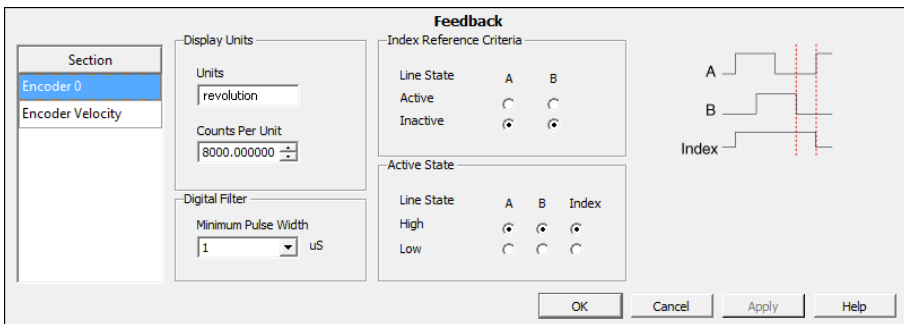

4. Click the **Stepper** button (  ) to open the **Stepper** page.
  - a. Ensure that the Stepper Output settings match the following:
    - **Output Mode**—Step and Direction
    - **Output Type**—Single-Ended
    - **Active State**—Low
  - b. Configure the Units and Steps Per Unit.
    - Select **rev** from the **Units** text box, or type **revolutions** if you prefer.
    - Set **Steps Per revolution** to 2,000.





**Note** The **Steps Per revolution** setting *must* match the Steps/Rev DIP switch setting. If you change the Steps/Rev setting using the DIP switches, update this setting to match.

- c. (Optional) Click the **Monitor** button (  ) and make the following changes to enable NI SoftMotion to disable the drive and turn off the Drive Enable signal when the specified position error limit is exceeded.



**Note** The **Monitor** button is greyed out if **Feedback Source** on the **Axis Settings** page is set to **None**.

- Enable the **Enforce Position Error Limit** checkbox.
- Set **Position Error Limit** to a reasonable tolerance for your system, such as 1.

5. Click the **Drive Enable** button (  ) and ensure that the Drive Enable settings match the following:
  - **Output Type**—Sourcing
  - **Active State**—Off
  - **Safe State**—On
6. If you connected the Out+/Out- signal, click the Digital I/O button (  ) and complete the following steps to configure the DI 0 signal:
  - a. Double-click the text in the **Mapping** column and select **Drive Fault/Alarm** from the dropdown list.
  - b. Ensure that the DI 0 settings match the following:
    - **Input Type**—Sinking
    - **Active State**—On
    - **Digital Filter**—50  $\mu$ s

7. Complete the following additional steps if you do not have limits and home connected at this time:
  - a. Click the **Limits & Home** button ().
  - b. In the **Forward Limit** and **Reverse Limit** sections ensure that the settings match the following:



**Note** These configuration settings disable limits for initial setup and testing purposes. National Instruments recommends connecting and enabling limits in your final application.

- Clear the **Enable** checkbox from both **Forward Limit** and **Reverse Limit**.
  - Set the **Active State** for both **Forward Limit** and **Reverse Limit** to **Off**. This prevents a limit warning even though limits are turned off.
- c. Open the **Home** section and clear the **Enable** checkbox.
8. Configure any additional I/O settings according to your system requirements, such as position compare or position capture signals.
  9. Click **OK** to close the **Axis Configuration** dialog box.
  10. Right-click the controller item in the **Project Explorer** window and select **Deploy All** to deploy the axis information.
  11. Select **File»Save Project** to save the project.

## Step 5: Enable and Test the Drive Using LabVIEW



Use the Interactive Test Panel to test and debug your motion system and configuration settings on the selected axis. With the Interactive Test Panel you can perform a simple straight-line move and monitor feedback position and position error information, move and I/O status information, change move constraints, get information about software errors and faults, and view position or velocity plots of the move.

Complete the following steps to test your setup after configuring the axis using the **Axis Configuration** dialog box.

1. Right-click the axis in the **Project Explorer** window and select **Interactive Test Panel** from the shortcut menu. Opening this dialog box sends the axis settings to the hardware and activates the I/O on the module.
2. On the **Move** tab set **Move Mode** to Relative Position and **Target Position** to 20 rev.
3. On the **Move Constraints** tab set **Velocity** to 2 rev/sec, **Acceleration** and **Deceleration** to 20 rev/sec<sup>2</sup>, and **Acceleration Jerk** and **Deceleration Jerk** to 200 rev/sec<sup>3</sup>. Using the encoder counts per revolution and stepper steps per revolution values specified in this tutorial the motor will move 20 revolutions at 120 rpm.



**Tip** Click the **Help** button () on the bottom of the dialog box for detailed information about the items available in this dialog box.

4. Click the **Enable** button (  ) on the bottom of the dialog box to enable the drive.
5. Click the **Start** button (  ) on the bottom of the dialog box to start the move with the configured options.
6. Use the **Status** and **Plots** tabs to monitor the move while it is in progress.  
Finalize your motion system setup by connecting and configuring additional I/O such as limits as required by your system using the 37-pin terminal block.

## Where To Go From Here

---

The following documents contain additional information that you may find helpful. All referenced documents ship with the product and are available at [ni.com/manuals](http://ni.com/manuals).

- Operating instructions for the controller and C Series module.
- *NI SMD-7611/7612 User Manual*
- *LabVIEW NI SoftMotion Module Help*—Use this help file to learn about using the NI SoftMotion Module in LabVIEW including information about function blocks and using the NI SoftMotion Module with the LabVIEW Project. To access this help file from LabVIEW, select **Help»LabVIEW Help**, then expand the *LabVIEW NI SoftMotion Module* book on the **Contents** tab.
- *LabVIEW Help*—Use the *LabVIEW Help* to access information about LabVIEW programming concepts, step-by-step instructions for using LabVIEW, and reference information about LabVIEW VIs, functions, palettes, menus, tools, properties, methods, events, dialog boxes, and so on. The *LabVIEW Help* also lists the LabVIEW documentation resources available from National Instruments. Access the *LabVIEW Help* by selecting **Help»LabVIEW Help**.
- *SoftMotion Examples*—After the configuration and testing of the motion system is complete, use SoftMotion API to program the motion control application in LabVIEW. Access the SoftMotion Examples by selecting **Help»Find Examples»Hardware Input and Output»Motion Control»SoftMotion**.



# Worldwide Support and Services

---

The National Instruments Web site is your complete resource for technical support. At [ni.com/support](http://ni.com/support) you have access to everything from troubleshooting and application development self-help resources to email and phone assistance from NI Application Engineers.

Visit [ni.com/services](http://ni.com/services) for NI Factory Installation Services, repairs, extended warranty, calibration, and other services.

Visit [ni.com/register](http://ni.com/register) to register your National Instruments product. Product registration facilitates technical support and ensures that you receive important information updates from NI.

A Declaration of Conformity (DoC) is our claim of compliance with the Council of the European Communities using the manufacturer's declaration of conformity. This system affords the user protection for electromagnetic compatibility (EMC) and product safety. You can obtain the DoC for your product by visiting [ni.com/certification](http://ni.com/certification). If your product supports calibration, you can obtain the calibration certificate for your product at [ni.com/calibration](http://ni.com/calibration).

National Instruments corporate headquarters is located at 11500 North Mopac Expressway, Austin, Texas, 78759-3504. National Instruments also has offices located around the world to help address your support needs. For telephone support in the United States, create your service request at [ni.com/support](http://ni.com/support) and follow the calling instructions or dial 512 795 8248. For telephone support outside the United States, visit the Worldwide Offices section of [ni.com/niglobal](http://ni.com/niglobal) to access the branch office Web sites, which provide up-to-date contact information, support phone numbers, email addresses, and current events.

Refer to the *NI Trademarks and Logo Guidelines* at [ni.com/trademarks](http://ni.com/trademarks) for more information on NI trademarks. Other product and company names mentioned herein are trademarks or trade names of their respective companies. For patents covering NI products/technology, refer to the appropriate location: **Help»Patents** in your software, the `patents.txt` file on your media, or the *National Instruments Patents Notice* at [ni.com/patents](http://ni.com/patents). You can find information about end-user license agreements (EULAs) and third-party legal notices in the `readme` file for your NI product. Refer to the *Export Compliance Information* at [ni.com/legal/export-compliance](http://ni.com/legal/export-compliance) for the NI global trade compliance policy and how to obtain relevant HTS codes, ECCNs, and other import/export data. NI MAKES NO EXPRESS OR IMPLIED WARRANTIES AS TO THE ACCURACY OF THE INFORMATION CONTAINED HEREIN AND SHALL NOT BE LIABLE FOR ANY ERRORS. U.S. Government Customers: The data contained in this manual was developed at private expense and is subject to the applicable limited rights and restricted data rights as set forth in FAR 52.227-14, DFAR 252.227-7014, and DFAR 252.227-7015.

© 2016 National Instruments. All rights reserved.