

COMPREHENSIVE SERVICES

We offer competitive repair and calibration services, as well as easily accessible documentation and free downloadable resources.

SELL YOUR SURPLUS

We buy new, used, decommissioned, and surplus parts from every NI series. We work out the best solution to suit your individual needs.

 Sell For Cash  Get Credit  Receive a Trade-In Deal

OBSOLETE NI HARDWARE IN STOCK & READY TO SHIP

We stock **New**, **New Surplus**, **Refurbished**, and **Reconditioned** NI Hardware.



Bridging the gap between the manufacturer and your legacy test system.

 1-800-915-6216

 www.apexwaves.com

 sales@apexwaves.com

All trademarks, brands, and brand names are the property of their respective owners.

Request a Quote

 **CLICK HERE**

NI-9214

GETTING STARTED GUIDE

NI 9214

16 TC, ± 78 mV, 24 Bit, 68 S/s Aggregate,
Isothermal Terminal Block

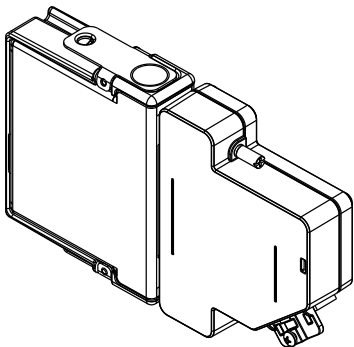

This document explains how to connect to the NI 9214.



Note Before you begin, complete the software and hardware installation procedures in your chassis documentation.



Note The guidelines in this document are specific to the NI 9214. The other components in the system might not meet the same safety ratings. Refer to the documentation for each component in the system to determine the safety and EMC ratings for the entire system.

Safety Guidelines

Operate the NI 9214 only as described in this document.



Caution Do not operate the NI 9214 in a manner not specified in this document. Product misuse can result in a hazard. You can compromise the safety protection built into the product if the product is damaged in any way. If the product is damaged, return it to NI for repair.



Hazardous Voltage This icon denotes a warning advising you to take precautions to avoid electrical shock.

Safety Guidelines for Hazardous Voltages

If hazardous voltages are connected to the device, take the following precautions. A hazardous voltage is a voltage greater than 42.4 Vpk voltage or 60 VDC to earth ground.



Caution Ensure that hazardous voltage wiring is performed only by qualified personnel adhering to local electrical standards.



Caution Do not mix hazardous voltage circuits and human-accessible circuits on the same module.



Caution Ensure that devices and circuits connected to the module are properly insulated from human contact.



Caution When module terminals are hazardous voltage LIVE (>42.4 Vpk/60 VDC), you must ensure that devices and circuits connected to the module are properly insulated from human contact. You must use the TB-9214 included with the NI 9214 to ensure that the terminals are not accessible.

Safety Voltages

Connect only voltages that are within the following limits:

Between any two terminals ± 30 V maximum

Isolation

Channel-to-channel None

Channel-to-earth ground

Continuous 250 Vrms, Measurement Category II

Withstand 2,300 Vrms, verified by a 5 s dielectric withstand test

Measurement Category II is for measurements performed on circuits directly connected to the electrical distribution system. This category refers to local-level electrical distribution, such as that provided by a standard wall outlet, for example, 115 V for U.S. or 230 V for Europe.



Caution Do not connect the NI 9214 to signals or use for measurements within Measurement Categories III or IV.

Safety Guidelines for Hazardous Locations

The NI 9214 is suitable for use in Class I, Division 2, Groups A, B, C, D, T4 hazardous locations; Class I, Zone 2, AEx nA IIC T4 and Ex nA IIC T4 hazardous locations; and nonhazardous locations only. Follow these guidelines if you are installing the NI 9214 in a potentially explosive environment. Not following these guidelines may result in serious injury or death.



Caution Do not disconnect I/O-side wires or connectors unless power has been switched off or the area is known to be nonhazardous.



Caution Do not remove modules unless power has been switched off or the area is known to be nonhazardous.



Caution Substitution of components may impair suitability for Class I, Division 2.



Caution For Division 2 and Zone 2 applications, install the system in an enclosure rated to at least IP54 as defined by IEC/EN 60079-15.



Caution For Division 2 and Zone 2 applications, connected signals must be within the following limits.

Capacitance

0.2 μ F maximum

Special Conditions for Hazardous Locations Use in Europe and Internationally

The NI 9214 has been evaluated as Ex nA IIC T4 Gc equipment under DEMKO Certificate No. 07 ATEX 0626664X and is IECEx UL 14.0089X certified. Each NI 9214 is marked  II 3G and is suitable for use in Zone 2 hazardous locations, in ambient temperatures of $-40\text{ }^{\circ}\text{C} \leq T_a \leq 70\text{ }^{\circ}\text{C}$. If you are using the NI 9214 in Gas Group IIC hazardous locations, you must use the device in an NI chassis that has been evaluated as Ex nC IIC T4, Ex IIC T4, Ex nA IIC T4, or Ex nL IIC T4 equipment.



Caution You must make sure that transient disturbances do not exceed 140% of the rated voltage.



Caution The system shall only be used in an area of not more than Pollution Degree 2, as defined in IEC 60664-1.



Caution The system shall be mounted in an ATEX/IECEX-certified enclosure with a minimum ingress protection rating of at least IP54 as defined in IEC/EN 60079-15.



Caution The enclosure must have a door or cover accessible only by the use of a tool.

Electromagnetic Compatibility Guidelines

This product was tested and complies with the regulatory requirements and limits for electromagnetic compatibility (EMC) stated in the product specifications. These requirements and limits provide reasonable protection against harmful interference when the product is operated in the intended operational electromagnetic environment.

This product is intended for use in industrial locations. However, harmful interference may occur in some installations, when the product is connected to a peripheral device or test object, or if the product is used in residential or commercial areas. To minimize interference with radio and television reception and prevent unacceptable performance degradation, install and use this

product in strict accordance with the instructions in the product documentation.

Furthermore, any changes or modifications to the product not expressly approved by National Instruments could void your authority to operate it under your local regulatory rules.



Caution To ensure the specified EMC performance, operate this product only with shielded cables and accessories.

Special Conditions for Marine Applications

Some products are Lloyd's Register (LR) Type Approved for marine (shipboard) applications. To verify Lloyd's Register certification for a product, visit ni.com/certification and search for the LR certificate, or look for the Lloyd's Register mark on the product.



Caution In order to meet the EMC requirements for marine applications, install the product in a shielded enclosure with shielded and/or filtered power and input/output ports. In addition, take precautions when designing, selecting, and installing measurement probes

and cables to ensure that the desired EMC performance is attained.

Preparing the Environment

Ensure that the environment in which you are using the NI 9214 meets the following specifications.

Operating temperature (IEC 60068-2-1, IEC 60068-2-2)	-40 °C to 70 °C
---	-----------------

Operating humidity (IEC 60068-2-78)	10% RH to 90% RH, noncondensing
--	------------------------------------

Pollution Degree	2
------------------	---

Maximum altitude	2,000 m
------------------	---------

Indoor use only.



Note Refer to the device datasheet on ni.com/manuals for complete specifications.

TB-9214 Pinout

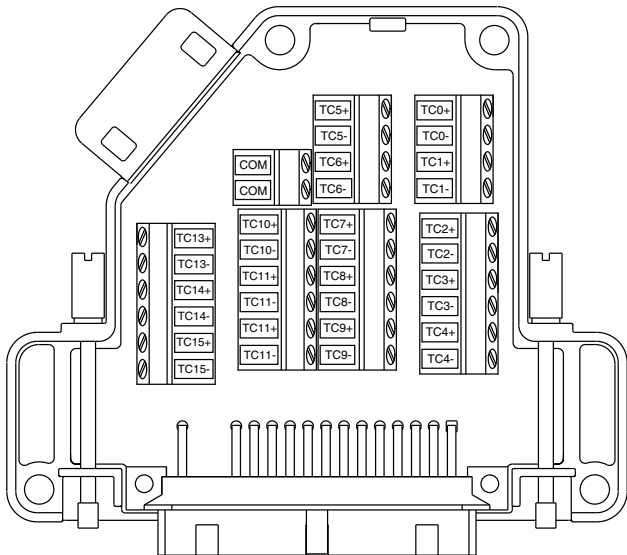
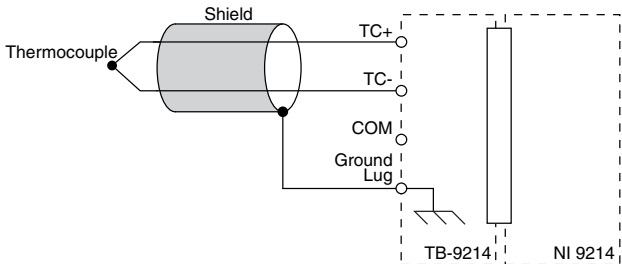

Table 1. Signal Descriptions

Signal	Description
COM	Common reference connection
TC+	Positive thermocouple connection
TC-	Negative thermocouple connection

Thermocouple Connections



For most applications, you do not need to connect COM. Connecting to COM is not necessary for the following configurations:

- All thermocouples are floating
- All thermocouples are referenced to the same common-mode voltage
- One thermocouple is reference to a common-mode voltage and all other thermocouples are floating

When COM is floating, the internal common-mode voltage of the input circuitry is the average of all the inputs.



Note When two or more thermocouples are referenced to different common-mode voltages, connect COM to a common-mode voltage reference that is within ± 1.2 V of the common-mode voltages of all thermocouple inputs.

NI 9214 Connection Guidelines

- Make sure that devices you connect to the NI 9214 are compatible with the module specifications.
- The shield grounding methodology can vary depending on the application.
- Refer to your thermocouple documentation or the thermocouple wire spool to determine which wire is the positive lead and which wire is the negative lead.

Minimizing Thermal Gradients

Changes in the ambient air temperature near the front connector or a thermocouple wire conducting heat directly to terminal junctions can cause thermal gradients. Observe the following

guidelines to minimize thermal gradients and improve the system accuracy.

- Use small-gauge thermocouple wire. Smaller wire transfers less heat to or from the terminal junction.
- Run thermocouple wiring together near the TB-9214 to keep the wires at the same temperature.
- Avoid running thermocouple wires near hot or cold objects.
- Minimize adjacent heat sources and air flow across the terminals.
- Keep the ambient temperature as stable as possible.
- Make sure the NI 9214 terminals are facing forward or upward.
- Keep the NI 9214 in a stable and consistent orientation.
- Allow the thermal gradients to settle after a change in system power or in ambient temperature. A change in system power can happen when the system powers on, the system comes out of sleep mode, or you insert/remove modules.
- If possible, use the foam pad in the TB-9214 opening to restrict airflow around the terminals.

Wiring the TB-9214

What to Use

- TB-9214
- 0.05 mm² to 0.5 mm² (30 AWG to 20 AWG) wire with 5.1 mm (0.2 in.) of the inner insulation stripped and 51 mm (2.0 in.) of the outer insulation stripped
- Zip tie
- Screwdriver

What to Do

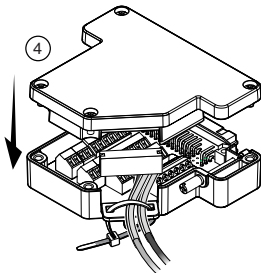
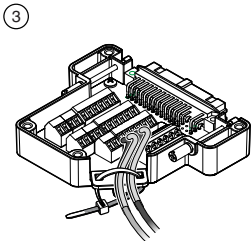
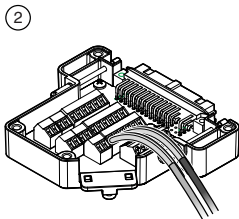
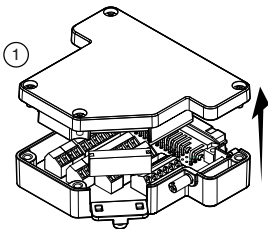

1. Loosen the captive screws on the TB-9214 and remove the top cover and foam pad.
2. Insert the stripped end of the wire fully into the appropriate terminal and tighten the screw for the terminal. Make sure no exposed wire extends past the screw terminal.
3. Route the wire through the TB-9214 opening, remove slack from the wiring, and secure the wires using a zip tie.
4. Replace the foam pad in the TB-9214 opening, reinstall the top cover, and tighten the captive screws.

Installing the TB-9214

What to Do

1. Connect the TB-9214 to the NI 9214 front connector.
2. Tighten the jackscrews to a maximum torque of $0.4 \text{ N} \cdot \text{m}$ ($3.6 \text{ lb} \cdot \text{in.}$). Do not overtighten the jackscrews.

Where to Go Next

CompactRIO

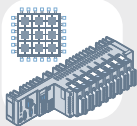

NI 9214 Datasheet



NI-RIO Help



LabVIEW FPGA Help

NI CompactDAQ



NI 9214 Datasheet



NI-DAQmx Help



LabVIEW Help

RELATED INFORMATION



C Series Documentation & Resources

ni.com/info ⇨ cseriesdoc



Services

ni.com/services



Located at ni.com/manuals



Installs with the software

Worldwide Support and Services

The NI website is your complete resource for technical support. At ni.com/support, you have access to everything from troubleshooting and application development self-help resources to email and phone assistance from NI Application Engineers.

Visit ni.com/services for NI Factory Installation Services, repairs, extended warranty, and other services.

Visit ni.com/register to register your NI product. Product registration facilitates technical support and ensures that you receive important information updates from NI.

A Declaration of Conformity (DoC) is our claim of compliance with the Council of the European Communities using the manufacturer's declaration of conformity. This system affords the user protection for electromagnetic compatibility (EMC) and product safety. You can obtain the DoC for your product by visiting ni.com/certification. If your product supports calibration, you can obtain the calibration certificate for your product at ni.com/calibration.

NI corporate headquarters is located at 11500 North Mopac Expressway, Austin, Texas, 78759-3504. NI also has offices located around the world. For telephone support in the United States, create your service request at ni.com/support or dial 1 866 ASK MYNI (275 6964). For telephone support outside the United States, visit the *Worldwide Offices* section of ni.com/niglobal to access the branch office websites, which provide up-to-date contact information, support phone numbers, email addresses, and current events.

Refer to the *NI Trademarks and Logo Guidelines* at ni.com/trademarks for information on NI trademarks. Other product and company names mentioned herein are trademarks or trade names of their respective companies. For patents covering NI products/technology, refer to the appropriate location: **Help»Patents** in your software, the `patents.txt` file on your media, or the *National Instruments Patent Notice* at ni.com/patents. You can find information about end-user license agreements (EULAs) and third-party legal notices in the readme file for your NI product. Refer to the *Export Compliance Information* at ni.com/legal/export-compliance for the NI global trade compliance policy and how to obtain relevant HTS codes, ECCNs, and other import/export data. NI MAKES NO EXPRESS OR IMPLIED WARRANTIES AS TO THE ACCURACY OF THE INFORMATION CONTAINED HEREIN AND SHALL NOT BE LIABLE FOR ANY ERRORS. U.S. Government Customers: The data contained in this manual was developed at private expense and is subject to the applicable limited rights and restricted data rights as set forth in FAR 52.227-14, DFAR 252.227-7014, and DFAR 252.227-7015.

© 2010—2016 National Instruments. All rights reserved.