

## COMPREHENSIVE SERVICES

We offer competitive repair and calibration services, as well as easily accessible documentation and free downloadable resources.

## SELL YOUR SURPLUS

We buy new, used, decommissioned, and surplus parts from every NI series. We work out the best solution to suit your individual needs.

 Sell For Cash    Get Credit    Receive a Trade-In Deal

## OBSOLETE NI HARDWARE IN STOCK & READY TO SHIP

We stock **New**, **New Surplus**, **Refurbished**, and **Reconditioned** NI Hardware.



*Bridging the gap between the manufacturer and your legacy test system.*

 1-800-915-6216

 [www.apexwaves.com](http://www.apexwaves.com)

 [sales@apexwaves.com](mailto:sales@apexwaves.com)

*All trademarks, brands, and brand names are the property of their respective owners.*

**Request a Quote**

 **CLICK HERE**

**NI-9247**

## DATASHEET

# NI 9247

## 3-Channel, 50 Arms Continuous, 24-Bit, Analog Input Module



- 3 isolated analog input channels, 50 kS/s per channel simultaneous sample rate
- 50 Arms continuous,  $\pm 147$  Apeak input range, 24-bit resolution (AC signals only)
- Designed for 1 A/5 A nominal CTs
- Up to 300 Vrms Channel-to-Earth and 480 Vrms Channel-to-Channel CAT III isolation
- Ring lug connectors for up to 10 AWG cables
- $-40$  °C to  $70$  °C operating temperature, 5 g vibration, 50 g shock

The NI 9247 current input module is a three channel 50 Arms module designed to support direct ring lug connectivity to three-phase high-current measurements of 1A and 5A current transformers (CTs). The NI 9247 is optimized for power, energy, and industrial applications that require continuous AC measurements up to 50 Arms,  $\pm 147$  Apeak, and withstand over 1250 Arms for one cycle.

The safety features, certifications, input ranges, overvoltage ranges, and connectivity will help engineers with applications such as:

- Power quality monitoring and metering
- Utility pole-mounted smart switches
- Utility pole-mounted smart grid reclosers
- Substation merging units
- Industrial machine measurements
  - Health monitoring
  - Predictive maintenance and prognosis
- Phasor Measurement Units (PMUs)

	<b>Kit Contents</b>	<ul style="list-style-type: none"> <li>• NI 9247</li> <li>• High Voltage Backshell</li> <li>• NI 9247 Getting Started Guide</li> </ul>
	<b>Recommended Accessories</b>	<ul style="list-style-type: none"> <li>• Ring Lugs (Quantity: 6)</li> </ul>

C SERIES 9227, 9246, 9247 CURRENT INPUT MODULE COMPARISON								
Product Name	Channels	Input Coupling	Input Noise	Measurement Range		1 s Withstand	Isolation	Connectivity
				Continuous	Instantaneous			
NI 9227	4	DC	0.4 mArms	5 Arms	10 Arms ±14 Apeak	10 Arms	CAT II 250 Vrms Ch-Ch	Screw Terminal
NI 9246	3	AC	0.25 mArms	20 Arms	20 Arms ±30 Apeak	500 Arms	CAT III 480 Vrms Ch-Ch	Ring Lug
NI 9247	3	AC	2.250 mArms	50 Arms	100 Arms ±147 Apeak	500 Arms	CAT III 480 Vrms Ch-Ch	Ring Lug

## NI C Series Overview



NI provides more than 100 C Series modules for measurement, control, and communication applications. C Series modules can connect to any sensor or bus and allow for high-accuracy measurements that meet the demands of advanced data acquisition and control applications.

- Measurement-specific signal conditioning that connects to an array of sensors and signals
- Isolation options such as bank-to-bank, channel-to-channel, and channel-to-earth ground
- -40 °C to 70 °C temperature range to meet a variety of application and environmental needs
- Hot-swappable

The majority of C Series modules are supported in both CompactRIO and CompactDAQ platforms and you can move modules from one platform to the other with no modification.

# CompactRIO



CompactRIO combines an open-embedded architecture with small size, extreme ruggedness, and C Series modules in a platform powered by the NI LabVIEW reconfigurable I/O (RIO) architecture. Each system contains an FPGA for custom timing, triggering, and processing with a wide array of available modular I/O to meet any embedded application requirement.

# CompactDAQ

CompactDAQ is a portable, rugged data acquisition platform that integrates connectivity, data acquisition, and signal conditioning into modular I/O for directly interfacing to any sensor or signal. Using CompactDAQ with LabVIEW, you can easily customize how you acquire, analyze, visualize, and manage your measurement data.



# Software

## LabVIEW Professional Development System for Windows



- Use advanced software tools for large project development
- Generate code automatically using DAQ Assistant and Instrument I/O Assistant
- Use advanced measurement analysis and digital signal processing
- Take advantage of open connectivity with DLLs, ActiveX, and .NET objects
- Build DLLs, executables, and MSI installers

## NI LabVIEW FPGA Module

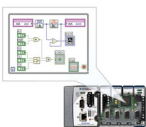

- Design FPGA applications for NI RIO hardware
- Program with the same graphical environment used for desktop and real-time applications
- Execute control algorithms with loop rates up to 300 MHz
- Implement custom timing and triggering logic, digital protocols, and DSP algorithms
- Incorporate existing HDL code and third-party IP including Xilinx IP generator functions
- Purchase as part of the LabVIEW Embedded Control and Monitoring Suite

## NI LabVIEW Real-Time Module

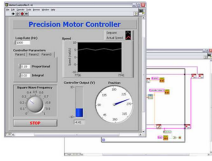

- Design deterministic real-time applications with LabVIEW graphical programming
- Download to dedicated NI or third-party hardware for reliable execution and a wide selection of I/O
- Take advantage of built-in PID control, signal processing, and analysis functions
- Automatically take advantage of multicore CPUs or set processor affinity manually
- Take advantage of real-time OS, development and debugging support, and board support
- Purchase individually or as part of a LabVIEW suite

## NI 9247 Theory of Operation

The NI 9247 measures currents that flow into AI+ and out of AI- as positive polarity. A + or - symbol is molded into the plastic near the respective ring lug terminal for each channel. Each channel is independently isolated from other channels and earth ground. The isolation ratings of 300 Vrms to Earth and 480 Vrms between channels makes the inputs suitable for direct current measurements at line voltages up to 277 V/480 V Cat III three-phase service levels.

### Circuitry

Each input signal of the NI 9247 is isolated, AC coupled, and then sampled by a single 24-bit ADC.

**Figure 1.** NI 9247 Input Circuitry

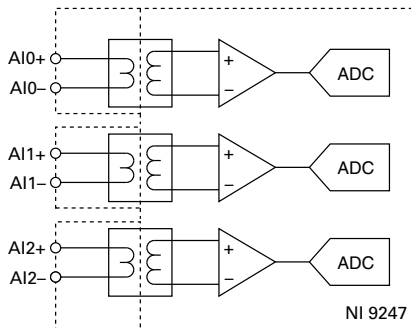

**Note** The NI 9247 does not measure DC currents.



**Caution** Connecting a DC current source to the NI 9247 outside of the input characteristics specifications may lead to invalid measurements.

The NI 9247 is suited for connection to the outputs of current transformers with 1 A or 5 A nominal ratings.

## DC Offset Currents



**Note** The NI 9247 does not measure DC currents.

The NI 9247 inputs are AC coupled through an internal transformer. Refer to the [Input Characteristics](#) section for information about the residual DC offset error the NI 9247 measures.

The DC value is ignored when you make frequency-specific measurements, such as harmonic analysis, phasor measurements, or fundamental line frequency amplitude measurements using algorithms such as those included with the NI LabVIEW Electrical Power Suite.

## Performing Analysis with DC-Sensitive Algorithms

If you perform analyses with DC-sensitive algorithms, such as instantaneous absolute peak detection or absolute value measurements, you should first remove the DC component of your measured waveforms by using a high-pass digital filter or by subtracting the average value of an integer number of power line cycles from your measurements.



**Caution** Connecting a DC current source to the NI 9247 outside of the specifications listed in the [Input Characteristics](#) section can lead to invalid measurements.

## Correcting Faulty Measurements

Although the NI 9247 cannot measure DC inputs, excessive DC components in the input currents will saturate the internal transformer and cause erroneous measurements. Refer to the [Input Characteristics](#) section for the typical limits of DC current that are tolerated before saturation begins. DC currents can occur in specific situations, such as with direct current measurements of a load. The following figure illustrates how faulty full-wave rectifiers in a load can cause half-wave rectification of a load, resulting in a DC offset.

**Figure 2.** Half-wave Rectification of a Load, Resulting in DC Offset



With complete half-wave rectification, the DC component of the input current is  $1/\pi$  x the peak current, and the RMS value is one half the peak current. In this scenario, the DC value must remain under the continuous allowed DC offset specification for correct measurements of the AC component of the waveform.

## Performing Indirect Current Measurements

When you use the NI 9247 to indirectly measure current through a current transformer, the current transformer blocks continuous DC currents from reaching the inputs of the NI 9247. Temporary offsets of the AC signal can still occur. In a network modeled as a first order system with a reactance to resistance ration of  $X/R$ , short circuit faults result in an offset current that decays with a time constant equal to  $(X/R) \div 2\pi f_{line}$ . For example, in a network with an  $X/R$  ratio of 32 and a line frequency of 50 Hz, the offset decays with a time constant of 100 ms. An  $X/R$  of 120 at 60 Hz decays with a time constant of 320 ms, as shown in the following figure. Refer to the [Input Characteristics](#) section for peak offset currents with first order decay limits. Peak offsets that exceed these limits can cause erroneous readings.

**Figure 3.** +7 A Input with +7 A Offset, Decaying at 320 ms

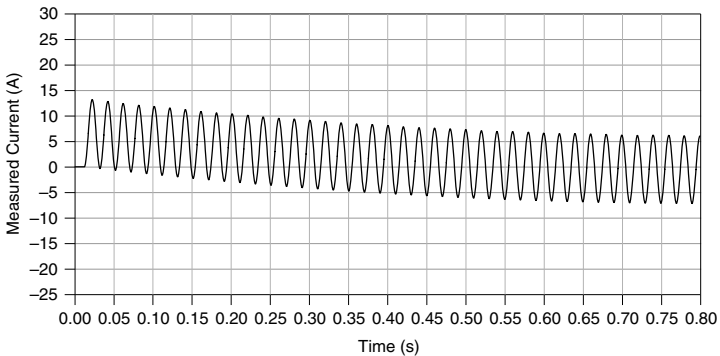

The following figure shows an excessive offset that causes saturation of the internal transformer and the resulting impact on measured current.

**Figure 4.** +15 A Input with +15 A Offset, Decaying at 320 ms

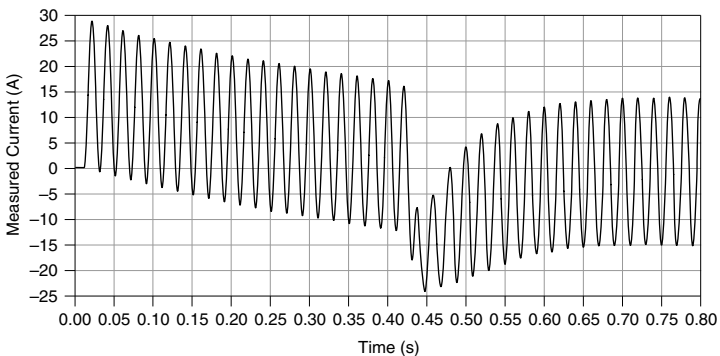

# Filtering

The NI 9247 uses a combination of analog and digital filtering to provide an accurate representation of in-band signals while rejecting out-of-band signals. The filters discriminate between signals based on the frequency range, or bandwidth, of the signal. The three important bandwidths to consider are the passband, the stopband, and the anti-imaging bandwidth.

The NI 9247 represents signals within the passband, as quantified primarily by passband ripple and phase nonlinearity. All signals that appear in the alias-free bandwidth are either unaliased signals or signals that have been filtered by at least the amount of the stopband rejection.

## Passband

The signals within the passband have frequency-dependent gain or attenuation. The small amount of variation in gain with respect to frequency is called the passband flatness. The digital filters of the NI 9247 adjust the frequency range of the passband to match the data rate. Therefore, the amount of gain or attenuation at a given frequency depends on the data rate.

## Stopband

The filter significantly attenuates all signals above the stopband frequency. The primary goal of the filter is to prevent aliasing. Therefore, the stopband frequency scales precisely with the data rate. The stopband rejection is the minimum amount of attenuation applied by the filter to all signals with frequencies within the stopband.

## Alias-Free Bandwidth

Any signals that appear in the alias-free bandwidth of the NI 9247 is not an aliased artifact of signals at a higher frequency. The alias-free bandwidth is defined by the ability of the filter to reject frequencies above the stopband frequency, and it is equal to the data rate minus the stopband frequency.

## Data Rates

The frequency of a master timebase ( $f_M$ ) controls the data rate ( $f_s$ ) of the NI 9247. The NI 9247 includes an internal master timebase with a frequency of 12.8 MHz, but the module also can accept an external master timebase or export its own master timebase. To synchronize the data rate of an NI 9247 with other modules that use master timebases to control sampling, all of the modules must share a single master timebase source.

The following equation provides the available data rates of the NI 9247:

$$f_s = \frac{f_M \div 256}{n}$$

where  $n$  is any integer from 1 to 31.

However, the data rate must remain within the appropriate data rate range. When using the internal master timebase of 12.8 MHz, the result is data rates of 50 kS/s, 25 kS/s, 16.667 kS/s,



and so on down to 1.613 kS/s depending on the value of  $n$ . When using an external timebase with a frequency other than 12.8 MHz, the NI 9247 has a different set of data rates.



**Note** The NI 9151 R Series Expansion chassis does not support sharing timebases between modules.

## NI 9247 Specifications

---

The following specifications are typical for the range -40 °C to 70 °C unless otherwise noted.



**Caution** To ensure the specified EMC performance, operate this product only with shielded cables and accessories.



**Caution** Do not operate the NI 9247 in a manner not specified in this document. Product misuse can result in a hazard. You can compromise the safety protection built into the product if the product is damaged in any way. If the product is damaged, return it to NI for repair.

## Input Characteristics

Number of channels.....	3 analog input channels
ADC resolution.....	24 bits
Type of ADC.....	Delta-Sigma (with analog prefiltering)
Sampling mode.....	Simultaneous
Instantaneous measuring range	
Minimum.....	±143 A
Typical.....	±147 A
Typical scaling coefficient.....	17.522 µA/LSB
Operating input rating.....	50 Arms; 100 Arms for 10 seconds, not to repeat more than once in 30 minutes
Overcurrent withstand rating.....	500 Arms for 1 second, not to repeat more than once in 30 minutes; 1250 Arms for 1 cycle (20 ms), not to repeat more than once in a minute
Input coupling.....	AC
Input impedance.....	0.2 mΩ
Internal master timebase ( $f_M$ )	
Frequency.....	12.8 MHz
Accuracy.....	±100 ppm max

Data rate range ( $f_s$ ) using internal master timebase

Minimum.....	1.613 kS/s
Maximum.....	50 kS/s

Data rate range ( $f_s$ ) using external master timebase

Minimum.....	390.625 S/s
Maximum.....	51.2 kS/s

Data rates ( $f_s$ )

$$\frac{f_M \div 256}{n}, n = 1, 2, \dots, 31$$

Passband frequency..... 10 Hz to  $0.453 \cdot f_s$

Passband flatness<sup>1</sup>

10 Hz to 1920 Hz.....	$\pm 0.1\%$ ( $\pm 0.009$ dB)
1.92 kHz to 22.5 kHz.....	$\pm 5.0\%$ ( $\pm 0.42$ dB)

Alias-free bandwidth.....  $0.453 \cdot f_s$

Stopband frequency.....  $0.547 \cdot f_s$

Stopband attenuation..... 95 dB

Input noise

1 kHz to 25 kHz bandwidth ( $f_s =$ ..... 50 kS/s)	2.25 mArms
25 Hz to 75 Hz or 30 Hz to..... 90 Hz bandwidth <sup>2</sup>	0.35 mArms

<sup>1</sup> Flatness refers to the difference in gain/error between any frequency in the defined range, with a reference frequency of 50 Hz or 60 Hz.

<sup>2</sup> When measuring the amplitude of the fundamental frequency over a single power line cycle, the measurement bandwidth is  $0.5 f_{\text{line}}$  to  $1.5 f_{\text{line}}$ .

**Table 1. Amplitude Accuracy (10 Hz to 1920 Hz)**

Measurement Conditions	Percent of Reading (Gain Error or Amplitude Accuracy)	
	1 Arms to 45 Arms	0 Arms to 100 Arms
Calibrated typical (23 °C, ±5 °C)	0.15%	0.3%
Calibrated max (-40 °C to 70 °C)	0.5%	1.0%
Uncalibrated <sup>3</sup> typical (23 °C, ±5 °C)	1.0%	1.2%
Uncalibrated <sup>3</sup> max (-40 °C to 70 °C)	2.5%	3.0%

Additional gain error, 1920 Hz to 22.5 kHz

1 Arms to 45 Arms.....±0.15% typical, ±0.6% max

0 Arms to 100 Arms.....±2% typical, ±4.5% max

Gain drift.....±15 ppm/°C

Gain mismatch between channels (with the

same amplitude and frequency on each channel

40 Hz to 70 Hz, 1 Arms to.....0.45% max

45 Arms

10 Hz to 1920 Hz, 0 Arms to.....0.6% max

100 Arms

1.92 kHz to 22.5 kHz, 0 Arms.....3.0% max

to 100 Arms

Input delay..... $(40 + [5/512])/f_s + 3.2 \mu s$

<sup>3</sup> Uncalibrated accuracy refers to the accuracy achieved when acquiring data in raw or unscaled modes and in which calibration constants that are stored in the module are not applied to the data.

<sup>4</sup> Phase error is the deviation in measured phase relative to the nominal input delay.

**Table 2. Phase Error (0 Arms to 45 Arms)**

Measurement Conditions	Phase Error <sup>4</sup>	
	10 Hz to 45 Hz	45 Hz to 1920 Hz
Typical (23 °C, ±5 °C)	0.2°	0.05°
Max (-40 °C to 70 °C)	0.5°	0.11°

Phase error, 1920 Hz to 22.5 kHz

- 0 Arms to 1 Arms.....±0.25°/kHz maximum
- 1 Arms to 45 Arms.....±0.09°/kHz maximum

Additional phase error, 45 Arms to.....±0.02°/Arms  
100 Arms

Phase mismatch between channels (with the same amplitude and frequency on each channel)

- 10 Hz to 45 Hz, 0 Arms to.....1.0° max  
100 Arms
- 45 Hz to 1920 Hz, 0 Arms to.....0.22° max  
100 Arms
- 1920 Hz to 22.5 kHz, 0 Arms to.....0.18°/kHz max  
100 Arms

DC offset error

- Calibrated.....±0.4 A maximum
- Uncalibrated.....±1.1 A maximum



**Note** The NI 9247 has AC coupled inputs and does not measure the DC current of the input signal. The DC offset error specification refers to the maximum possible DC value returned by the NI 9247.

Allowable DC offset input

- Continuous.....1.5 A
- Exponentially decaying
  - 100 ms.....20 Apeak
  - 320 ms.....7 Apeak



**Note** A 100 ms time constant corresponds to X/R impedance ratios of 32 for 50 Hz signals and 38 for 60 Hz signals. 320 ms corresponds to ratios of 100 for 50 Hz and 120 for 60 Hz.



**Caution** Input signals that contain DC offsets that exceed the listed values can cause erroneous measurements.

#### Crosstalk

( $f_{in}$  = 50 Hz or 60 Hz).....0.002% (-94 dB)

( $f_{in}$  = 1 kHz).....0.02% (-74 dB)

Common Mode Rejection Ratio.....7.5  $\mu$ A/V/Hz (375  $\mu$ A/V at 50 Hz)  
(CMRR)

#### Total Harmonic Distortion (THD),

( $f_{in}$  = 50 Hz or 60 Hz)

$I_{in}$  = < 45 A.....0.01% (-80 dB)

$I_{in}$  = 45 A to 100 A.....0.1% (-60 dB)

## Power Requirements

#### Power consumption from chassis

Active mode.....1 W max

Sleep mode.....25  $\mu$ W max

#### Thermal dissipation (at 70 °C)

Active mode.....2.1 W max

Sleep mode.....1.5 W max

## Physical Characteristics

If you need to clean the module, wipe it with a dry towel.



**Tip** For two-dimensional drawings and three-dimensional models of the C Series module and connectors, visit [ni.com/dimensions](https://ni.com/dimensions) and search by module number.

#### Connector wiring

Gauge.....2.58 mm<sup>2</sup> (10 AWG) stranded core wire with  
an insulated ring terminal

#### Screw specifications

Screw size.....6-32

Maximum screw length.....5.08 mm (0.200 in.)

#### Ring/Spade terminal

Maximum width.....9.525 mm (0.375 in.) of ring lug

Recommended torque.....1.4 N · m (12 lb · in.)

Weight.....248 g (8.75 oz)

# Safety Voltages

Connect only voltages that are within the following limits:

Maximum working voltage, channel-to-earth ground

Continuous

- Up to 2,000 m altitude.....300 Vrms, Measurement Category III
- Up to 5,000 m altitude.....150 Vrms, Measurement Category III or  
300 Vrms, Measurement Category II

Maximum working voltage, channel-to-channel

Continuous

- Up to 2,000 m altitude.....480 Vrms, Measurement Category III
- Up to 5,000 m altitude.....300 Vrms, Measurement Category III or  
480 Vrms, Measurement Category II

Withstand

- Channel-to-channel.....3510 Vrms, verified by a 5 s dielectric  
withstand test
- Channel-to-earth ground.....3510 Vrms, verified by a 5 s dielectric  
withstand test

Measurement Category II is for measurements performed on circuits directly connected to the electrical distribution system. This category refers to local-level electrical distribution, such as that provided by a standard wall outlet, for example, 115 V for U.S. or 230 V for Europe.

Measurement Category III is for measurements performed in the building installation at the distribution level. This category refers to measurements on hard-wired hardware such as hardware in fixed installations, distribution boards, and circuit breakers. Other examples are wiring, including cables, bus bars, junction boxes, switches, socket outlets in the fixed installation, and stationary motors with permanent connections to fixed installations.



**Caution** Do not connect the NI 9247 to signals or use for measurements within Measurement Category IV.



**Caution** The NI 9247 ships with a connector backshell to ensure that the terminals are not accessible. Do not operate the device without first installing this backshell.

**Figure 5.** NI 9247 with Backshell

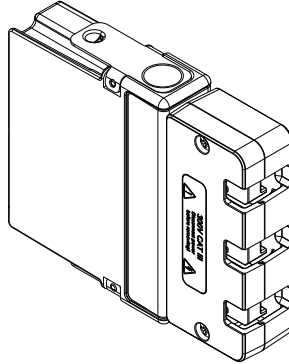

## Safety

This product is designed to meet the requirements of the following electrical equipment safety standards for measurement, control, and laboratory use:

- IEC 61010-1, EN 61010-1
- UL 61010-1, CSA 61010-1



**Note** For UL and other safety certifications, refer to the product label or the [Online Product Certification](#) section.

## Electromagnetic Compatibility

This product meets the requirements of the following EMC standards for electrical equipment for measurement, control, and laboratory use:

- EN 61326-1 (IEC 61326-1): Class A emissions; Industrial immunity
- EN 55011 (CISPR 11): Group 1, Class A emissions
- EN 55022 (CISPR 22): Class A emissions
- EN 55024 (CISPR 24): Immunity
- AS/NZS CISPR 11: Group 1, Class A emissions
- AS/NZS CISPR 22: Class A emissions

- FCC 47 CFR Part 15B: Class A emissions
- ICES-001: Class A emissions



**Note** In the United States (per FCC 47 CFR), Class A equipment is intended for use in commercial, light-industrial, and heavy-industrial locations. In Europe, Canada, Australia and New Zealand (per CISPR 11) Class A equipment is intended for use only in heavy-industrial locations.



**Note** Group 1 equipment (per CISPR 11) is any industrial, scientific, or medical equipment that does not intentionally generate radio frequency energy for the treatment of material or inspection/analysis purposes.



**Note** For EMC declarations and certifications, and additional information, refer to the [Online Product Certification](#) section.

## CE Compliance

---

This product meets the essential requirements of applicable European Directives, as follows:

- 2014/35/EU; Low-Voltage Directive (safety)
- 2014/30/EU; Electromagnetic Compatibility Directive (EMC)

## Online Product Certification

---

Refer to the product Declaration of Conformity (DoC) for additional regulatory compliance information. To obtain product certifications and the DoC for this product, visit [ni.com/certification](http://ni.com/certification), search by model number or product line, and click the appropriate link in the Certification column.

## Shock and Vibration

---

To meet these specifications, you must panel mount the system.

### Operating vibration

Random (IEC 60068-2-64).....5 g<sub>rms</sub>, 10 Hz to 500 Hz

Sinusoidal (IEC 60068-2-6).....5 g, 10 Hz to 500 Hz

Operating shock (IEC 60068-2-27).....30 g, 11 ms half sine; 50 g, 3 ms half sine;  
18 shocks at 6 orientations



# Environmental

---

Refer to the manual for the chassis you are using for more information about meeting these specifications.

Operating temperature.....-40 °C to 70 °C  
(IEC 60068-2-1, IEC 60068-2-2)

Storage temperature.....-40 °C to 85 °C  
(IEC 60068-2-1, IEC 60068-2-2)

Ingress protection.....IP 40  
(with power plug attached)

Operating humidity.....10% RH to 90% RH, noncondensing  
(IEC 60068-2-56)

Storage humidity (IEC 60068-2-56).....5% RH to 95% RH, noncondensing

Pollution Degree.....2

Maximum altitude.....5,000 m

Indoor use only.

# Environmental Management

---

NI is committed to designing and manufacturing products in an environmentally responsible manner. NI recognizes that eliminating certain hazardous substances from our products is beneficial to the environment and to NI customers.

For additional environmental information, refer to the *Minimize Our Environmental Impact* web page at [ni.com/environment](http://ni.com/environment). This page contains the environmental regulations and directives with which NI complies, as well as other environmental information not included in this document.

# Waste Electrical and Electronic Equipment (WEEE)

---



**EU Customers** At the end of the product life cycle, all NI products must be disposed of according to local laws and regulations. For more information about how to recycle NI products in your region, visit [ni.com/environment/weee](http://ni.com/environment/weee).

# 电子信息产品污染控制管理办法（中国 RoHS）

---



**中国客户** National Instruments 符合中国电子信息产品中限制使用某些有害物质指令 (RoHS)。关于 National Instruments 中国 RoHS 合规性信息，请登录 [ni.com/environment/rohs\\_china](http://ni.com/environment/rohs_china)。(For information about China RoHS compliance, go to [ni.com/environment/rohs\\_china](http://ni.com/environment/rohs_china).)

## Calibration

---

You can obtain the calibration certificate and information about calibration services for the NI 9247 at [ni.com/calibration](http://ni.com/calibration).

Calibration interval..... 1 year

Refer to the *NI Trademarks and Logo Guidelines* at [ni.com/trademarks](http://ni.com/trademarks) for information on National Instruments trademarks. Other product and company names mentioned herein are trademarks or trade names of their respective companies. For patents covering National Instruments products/technology, refer to the appropriate location: **Help»Patents** in your software, the `patents.txt` file on your media, or the *National Instruments Patent Notice* at [ni.com/patents](http://ni.com/patents). You can find information about end-user license agreements (EULAs) and third-party legal notices in the readme file for your NI product. Refer to the *Export Compliance Information* at [ni.com/legal/export-compliance](http://ni.com/legal/export-compliance) for the National Instruments global trade compliance policy and how to obtain relevant HTS codes, ECCNs, and other import/export data. NI MAKES NO EXPRESS OR IMPLIED WARRANTIES AS TO THE ACCURACY OF THE INFORMATION CONTAINED HEREIN AND SHALL NOT BE LIABLE FOR ANY ERRORS. U.S. Government Customers: The data contained in this manual was developed at private expense and is subject to the applicable limited rights and restricted data rights as set forth in FAR 52.227-14, DFAR 252.227-7014, and DFAR 252.227-7015.

© 2015 National Instruments. All rights reserved.

376925A-01 May15