

## COMPREHENSIVE SERVICES

We offer competitive repair and calibration services, as well as easily accessible documentation and free downloadable resources.

## SELL YOUR SURPLUS

We buy new, used, decommissioned, and surplus parts from every NI series. We work out the best solution to suit your individual needs.

 Sell For Cash    Get Credit    Receive a Trade-In Deal

## OBSOLETE NI HARDWARE IN STOCK & READY TO SHIP

We stock **New**, **New Surplus**, **Refurbished**, and **Reconditioned** NI Hardware.



*Bridging the gap between the manufacturer and your legacy test system.*

 1-800-915-6216

 [www.apexwaves.com](http://www.apexwaves.com)

 [sales@apexwaves.com](mailto:sales@apexwaves.com)

*All trademarks, brands, and brand names are the property of their respective owners.*

**Request a Quote**

 **CLICK HERE**

**NI-9251**

## DATASHEET

# NI 9251 with mini XLR



2 AI, 3 Vrms, 24 Bit, 102.4 kS/s/ch Simultaneous, AC/DC Coupling



- Mini-XLR connectivity
- -106 dBc THD+N
- <math><10 \mu\text{Vrms}</math> noise

The NI 9251 with mini XLR is a 2-channel analog input module for CompactDAQ and CompactRIO with a 102.4 kS/s update rate, 24-bit resolution, and 3 Vrms input range. Channels on the NI 9251 with mini XLR allow for high dynamic range measurements necessary to fully test and evaluate modern audio outputs used in most consumer electronic devices. Unlike sound-card-based solutions, the NI 9251 with mini XLR can be deployed quickly and re-calibrated to guarantee long-term measurement repeatability and increased test system up-time. The NI 9251 with mini XLR also features  $\pm 30$  V overvoltage protection and short circuit protection for safe deployment.

Pairing the NI 9251 with mini XLR with an NI 9260 will enable users to perform the full suite of measurements typically performed with high-end audio analyzers in a CompactDAQ or CompactRIO chassis, greatly improving the footprint and portability of those measurements.

 <b>Kit Contents</b>	<ul style="list-style-type: none"><li>• NI 9251 with mini XLR</li><li>• NI 9251 with mini XLR Getting Started Guide</li></ul>
 <b>Target Applications</b>	<ul style="list-style-type: none"><li>• Audio Testing</li><li>• Noise, Vibrations, and Harshness (NVH)</li></ul>

# NI C Series Overview

---



NI provides more than 100 C Series modules for measurement, control, and communication applications. C Series modules can connect to any sensor or bus and allow for high-accuracy measurements that meet the demands of advanced data acquisition and control applications.

- Measurement-specific signal conditioning that connects to an array of sensors and signals
- Isolation options such as bank-to-bank, channel-to-channel, and channel-to-earth ground
- -40 °C to 70 °C temperature range to meet a variety of application and environmental needs
- Hot-swappable

The majority of C Series modules are supported in both CompactRIO and CompactDAQ platforms and you can move modules from one platform to the other with no modification.

## CompactRIO



CompactRIO combines an open-embedded architecture with small size, extreme ruggedness, and C Series modules in a platform powered by the NI LabVIEW reconfigurable I/O (RIO) architecture. Each system contains an FPGA for custom timing, triggering, and processing with a wide array of available modular I/O to meet any embedded application requirement.

## CompactDAQ

CompactDAQ is a portable, rugged data acquisition platform that integrates connectivity, data acquisition, and signal conditioning into modular I/O for directly interfacing to any sensor or signal. Using CompactDAQ with LabVIEW, you can easily customize how you acquire, analyze, visualize, and manage your measurement data.



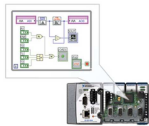
# Software

## LabVIEW Professional Development System for Windows



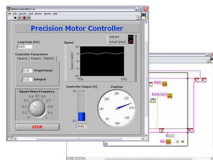
- Use advanced software tools for large project development
- Generate code automatically using DAQ Assistant and Instrument I/O Assistant
- Use advanced measurement analysis and digital signal processing
- Take advantage of open connectivity with DLLs, ActiveX, and .NET objects
- Build DLLs, executables, and MSI installers

## NI LabVIEW FPGA Module



- Design FPGA applications for NI RIO hardware
- Program with the same graphical environment used for desktop and real-time applications
- Execute control algorithms with loop rates up to 300 MHz
- Implement custom timing and triggering logic, digital protocols, and DSP algorithms
- Incorporate existing HDL code and third-party IP including Xilinx IP generator functions
- Purchase as part of the LabVIEW Embedded Control and Monitoring Suite

## NI LabVIEW Real-Time Module



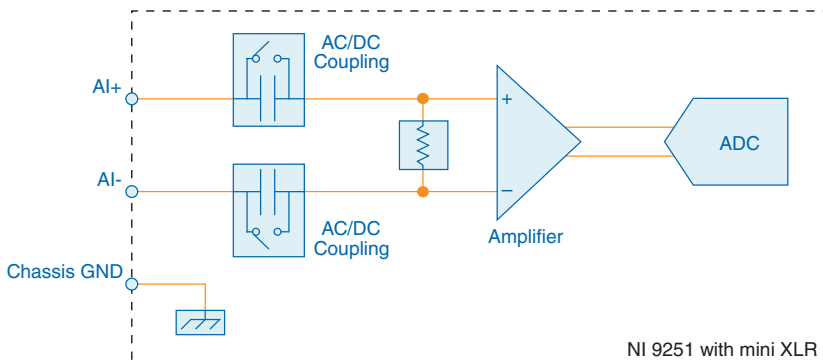
- Design deterministic real-time applications with LabVIEW graphical programming
- Download to dedicated NI or third-party hardware for reliable execution and a wide selection of I/O
- Take advantage of built-in PID control, signal processing, and analysis functions
- Automatically take advantage of multicore CPUs or set processor affinity manually
- Take advantage of real-time OS, development and debugging support, and board support
- Purchase individually or as part of a LabVIEW suite

# Circuitry

The NI 9251 with mini XLR can measure a maximum signal of 3 Vrms on AI+ with respect to AI-. The ground pin is connected to chassis ground internally, while the AI+ and AI- have a 2 MΩ resistor that is also connected to chassis ground. You can connect a floating differential

signal or grounded differential signal to the input. Each channel also has  $\pm 30$  V overvoltage protection.

**Figure 1.** NI 9251 with mini XLR Circuitry



## Filtering

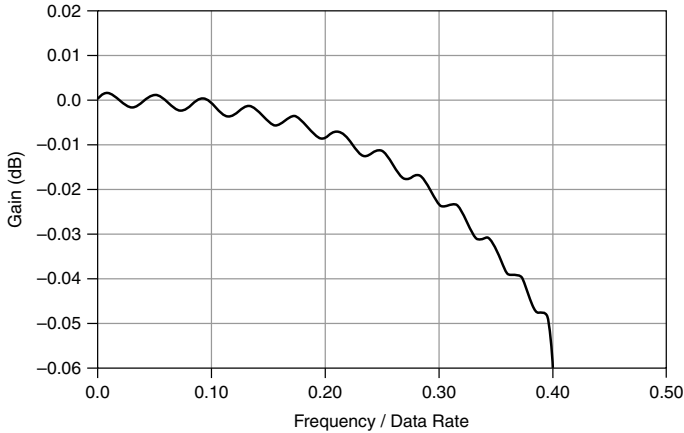
The NI 9251 with mini XLR uses a combination of analog and digital filtering to provide an accurate representation of in-band signals and reject out-of-band signals. The filters discriminate between signals based on the frequency range, or bandwidth, of the signal. The three important bandwidths to consider are the passband, the stopband, and the anti-imaging bandwidth.

The NI 9251 with mini XLR represents signals within the passband, as quantified primarily by passband ripple and phase nonlinearity. All signals that appear in the alias-free bandwidth are either unaliased signals or signals that have been filtered by at least the amount of the stopband rejection.

## Passband

The signals within the passband have frequency-dependent gain or attenuation. The small amount of variation in gain with respect to frequency is called the passband flatness. The digital filters of the NI 9251 with mini XLR adjust the frequency range of the passband to match the data rate. Therefore, the amount of gain or attenuation at a given frequency depends on the data rate.

**Figure 2.** Typical Passband Flatness in DC Coupling for the NI 9251 with mini XLR at the Maximum Data Rate



**Note** The passband flatness improves at lower sample rates compared to the graph.

## Stopband

The filter significantly attenuates all signals above the stopband frequency. The primary goal of the filter is to prevent aliasing. Therefore, the stopband frequency scales precisely with the data rate. The stopband rejection is the minimum amount of attenuation applied by the filter to all signals with frequencies within the stopband.

## Alias-Free Bandwidth

Any signals that appear in the alias-free bandwidth are not aliased artifacts of signals at a higher frequency. The alias-free bandwidth is defined by the ability of the filter to reject frequencies above the stopband frequency. The alias-free bandwidth is equal to the data rate minus the stopband frequency.

## Data Rates

The frequency of a master timebase ( $f_M$ ) controls the data rate ( $f_s$ ) of the NI 9251 with mini XLR. The NI 9251 with mini XLR includes an internal master timebase with a frequency of 13.1072 MHz. Using the internal master timebase of 13.1072 MHz results in data rates of 102.4 kS/s, 51.2 kS/s, 25.6 kS/s, 17.067 kS/s, and so on down to 267 S/s, depending on the decimation rate and the value of the clock divider. However, the data rate must remain within the appropriate data rate range.

The following equation provides the available data rates of the NI 9251 with mini XLR:

$$f_s = \frac{f_M}{4 \times a \times b}$$

where  $a$  is the decimation rate (32, 64, 128, 256, 512, 1024), and  $b$  is the clock divider (integer between 1 and 12).



**Note**

$$\frac{f_M}{b}$$

must be greater than or equal to 1 MHz.

There are multiple combinations of clock dividers and decimation rates that yield the same data rate. The software always picks the highest decimation rate for the selected data rate. The following table lists available data rates with the internal master timebase.

**Table 1.** Available Data Rates with the Internal Master Timebase

$f_s$ (kS/s)	Decimation Rate	Clock Divider
102.400	32	1
51.200	64	1
34.133	32	3
25.600	128	1
20.480	32	5
17.067	64	3
14.629	32	7
12.800	256	1
11.378	32	9
10.240	64	5
9.309	32	11
8.533	128	3
7.314	64	7
6.400	512	1
5.689	64	9
5.120	128	5
4.655	64	11
4.267	256	3

**Table 1.** Available Data Rates with the Internal Master Timebase (Continued)

$f_s$ (kS/s)	Decimation Rate	Clock Divider
3.657	128	7
3.200	1024	1
2.844	128	9
2.560	256	5
2.327	128	11
2.133	512	3
1.829	256	7
1.600	1024	2
1.422	256	9
1.280	512	5
1.164	256	11
1.067	1024	3
0.914	512	7
0.800	1024	4
0.711	512	9
0.640	1024	5
0.582	512	11
0.533	1024	6
0.457	1024	7
0.400	1024	8
0.356	1024	9
0.320	1024	10
0.291	1024	11
0.267	1024	12

The NI 9251 with mini XLR also can accept an external master timebase or export its own master timebase. To synchronize the data rate of an NI 9251 with mini XLR with other modules that use master timebases to control sampling, all of the modules must share a single master timebase source. When using an external timebase with a frequency other than 13.1072 MHz, the NI 9251 with mini XLR has a different set of data rates. Refer to the



software help for information about configuring the master timebase source for the NI 9251 with mini XLR.



**Note** The cRIO-9151 R Series Expansion chassis does not support sharing timebases between modules.

## NI 9251 with mini XLR Specifications

The following specifications are typical for the range -40 °C to 70 °C unless otherwise noted.



**Caution** Do not operate the NI 9251 with mini XLR in a manner not specified in this document. Product misuse can result in a hazard. You can compromise the safety protection built into the product if the product is damaged in any way. If the product is damaged, return it to NI for repair.

### Input Characteristics

Number of channels	2 analog input channels
ADC resolution	24 bits
Type of ADC	Delta-Sigma with analog prefiltering
Sampling mode	Simultaneous
Input coupling	Software-selectable AC/DC
Internal master timebase ( $f_M$ )	
Frequency	13.1072 MHz
Accuracy	±100 ppm maximum
Data rate range ( $f_s$ )	
Using internal master timebase	
Minimum	267 S/s
Maximum	102.4 kS/s
Using external master timebase	
Minimum	244.141 S/s
Maximum	102.734 kS/s
Data rate <sup>1</sup>	$f_s = \frac{f_M}{4 \times a \times b}$
Input delay <sup>2</sup>	$34/f_s + 2.5 \mu\text{s}$
Overvoltage protection	±30 V

<sup>1</sup> The data rate must remain within the appropriate data rate range.

<sup>2</sup> 2.5 μs is applicable for DC to 40 kHz in DC coupling and 50 Hz to 40 kHz in AC coupling.

### Input resistance

Single ended	2 M $\Omega$
Differential	4 M $\Omega$

Input capacitance <sup>3</sup>	940 pF
--------------------------------	--------

### Input voltage range (Differential)

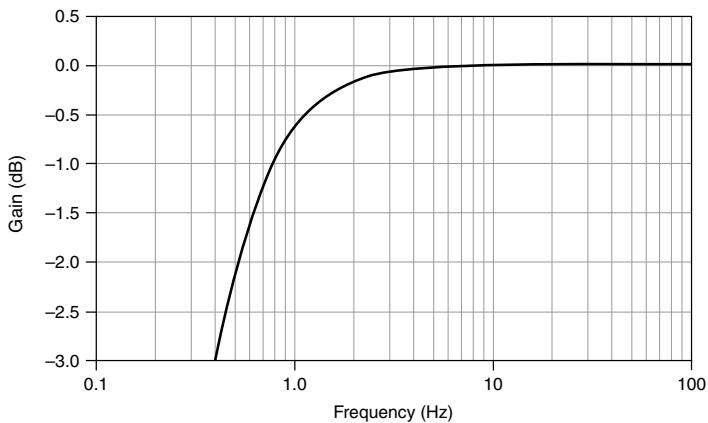
Minimum	3.000 Vrms ( $\pm$ 4.243 Vpk)
Typical	3.058 Vrms ( $\pm$ 4.325 Vpk)
Scaling coefficient	515,589 pV/LSB

Maximum input voltage <sup>3</sup>	$\pm$ 4.464 Vpk
------------------------------------	-----------------

### High pass filter cutoff frequency (AC)

-3 dB	0.4 Hz
-0.1 dB	2.61 Hz

**Figure 3. High Pass Filter Frequency Response**



<sup>3</sup> From input pin to ground

**Table 2.** Accuracy in DC Coupling

Measurement Conditions	Percent of Reading (Gain Error)	Percent of Range <sup>4</sup> (Offset Error)
Maximum (-40 °C to 70 °C)	±0.212%	±0.155%
Typical (23 °C, ±5 °C)	±0.056%	±0.023%

## Stability of Accuracy

Gain drift 7 ppm/°C

Offset drift 31 µV/°C

## Passband, -0.1 dB

Frequency 0.4 \*  $f_s$ Flatness (peak-to-peak)<sup>5</sup>

DC to 20 kHz 0.03 dB maximum

DC to 40 kHz 0.09 dB maximum

## Phase linearity

## DC coupling

DC to 20 kHz 0.03° maximum

DC to 40 kHz 0.22° maximum

## AC coupling

100 Hz to 40 kHz 0.22° maximum

## Channel-to-channel mismatch

## Gain

DC to 20 kHz 0.075 dB maximum

DC to 40 kHz 0.115 dB maximum

Phase ( $f_{in}$  in kHz)  $f_{in} * 0.03^\circ$  maximum

## Stopband

Frequency 0.499 \*  $f_s$ 

Rejection 105 dB

## Alias free bandwidth

0.5 \*  $f_s$ <sup>4</sup> Range equals 4.3251 Vpk<sup>5</sup> With 40 Ω source impedance

Alias rejection @ oversample rate

$f_s = 102.4 \text{ kS/s}$	100 dB at 3.2768 MHz
$f_s = 267 \text{ S/s}$	78 dB at 273 kHz

**Table 3.** Idle Channel Noise (AC Coupling and DC Coupling)

Data Rate (S/s)	ADC Decimation Ratio	Noise ( $\mu\text{Vrms}$ )
102,400	32	8.5
51,200	64	5.9
25,600	128	4.2
12,800	256	3.1
6,400	512	2.3
3,200	1,024	1.8

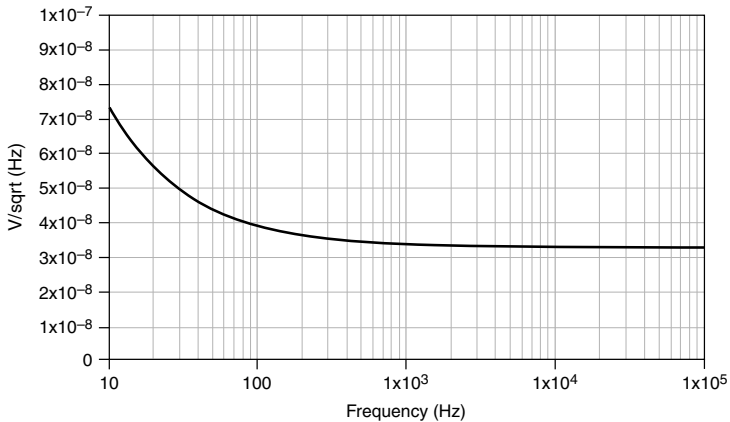


**Note** The noise specifications assume the NI 9251 with mini XLR is using the internal master timebase frequency of 13.1072 MHz.

Spectral noise density

$$\frac{33.3\text{nV}}{\sqrt{\text{Hz}}} @ 1 \text{ kHz}$$

**Figure 4.** Spectral Noise Density versus Frequency



**Table 4.** Dynamic Range (1 kHz Input Frequency, -60 dBFS amplitude,  $BW=0.5 * f_s$ )

Data Rate (S/s)	ADC Decimation Ratio	AC or DC Coupled (dBFS)
102,400	32	111
51,200	64	114
25,600	128	117
12,800	256	120
6,400	512	122
3,200	1,024	124

## Crosstalk (CH to CH)

$$f_{in} \leq 1 \text{ kHz} \quad -142 \text{ dB}$$

$$f_{in} \leq 20 \text{ kHz} \quad -118 \text{ dB}$$

$$f_{in} \leq 40 \text{ kHz} \quad -112 \text{ dB}$$

## Common mode rejection ratio (CMRR)

$$f_{in} = 20 \text{ Hz to } 1 \text{ kHz} \quad 49 \text{ dB minimum, with AC coupling}$$

$$f_{in} = \text{DC to } 1 \text{ kHz} \quad 50 \text{ dB minimum, with DC coupling}$$

Intermodulation distortion (IMD)<sup>6</sup>

$$f_s = 51.2 \text{ kS/s} \quad -108 \text{ dB}$$

$$f_s = 102.4 \text{ kS/s} \quad -105 \text{ dB}$$

Non-harmonic SFDR ( $f_s = 102.4 \text{ kS/s}$ ) 135 dBFS

## Total Harmonic Distortion (THD)

$$f_s = 51.2 \text{ kS/s}$$

$$1 \text{ kHz} \quad -114 \text{ dBc}$$

$$20 \text{ Hz to } 22 \text{ kHz} \quad -111 \text{ dBc}$$

$$f_s = 102.4 \text{ kS/s}$$

$$8 \text{ kHz} \quad -110 \text{ dBc}$$

$$20 \text{ Hz to } 44 \text{ kHz} \quad -108 \text{ dBc}$$

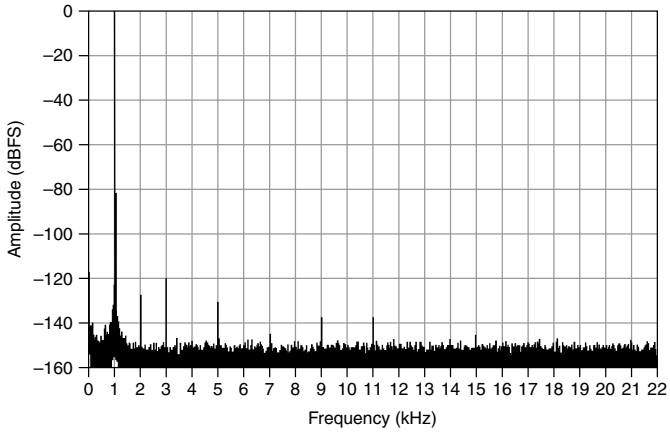
<sup>6</sup> Test standards:

- SMPTE 60 Hz + 7 kHz, amplitude ratio 4:1 with total amplitude at 0dBFS
- CCIF 14 kHz + 15 kHz, amplitude ratio 1:1 with each tone amplitude at -6 dBFS

Up to fifth order harmonic

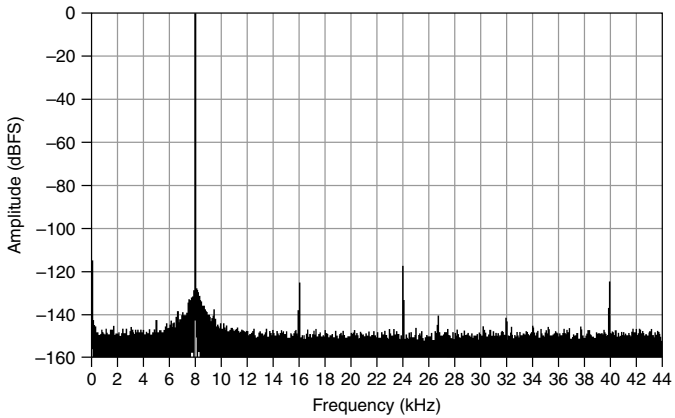
**Figure 5.** FFT of -1 dBFS, 1 kHz Tone Sampled at 51.2 kS/s (Unaveraged Computation of 65,536 Samples)

---

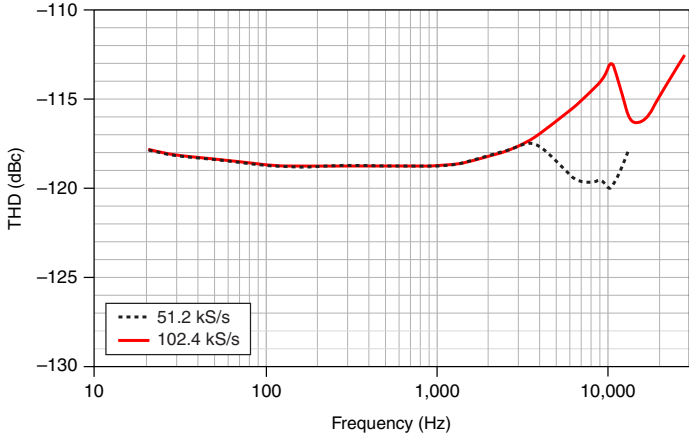


**Figure 6.** FFT of -1 dBFS, 8 kHz Tone Sampled at 102.4 kS/s (Unaveraged Computation of 262,144 Samples)

---



**Figure 7. THD versus Frequency**



**Total Harmonic Distortion + Noise (THD+N)**

$f_s = 51.2 \text{ kS/s}$

1 kHz -111 dBc

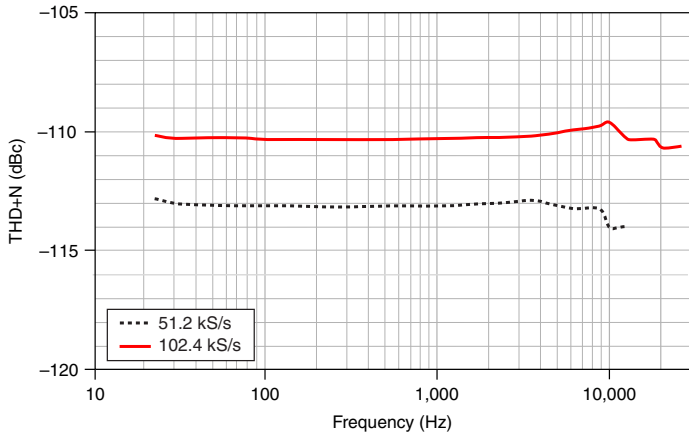
20 Hz to 22 kHz -109 dBc

$f_s = 102.4 \text{ kS/s}$

8 kHz -107 dBc

20 Hz to 44 kHz -106 dBc

**Figure 8. THD+N versus Frequency**



# Power Requirements

---

## Power consumption from chassis

Active mode	0.89 W max
Sleep mode	53 $\mu$ W max

---

## Thermal dissipation (at 70 °C)

Active mode	1.31 W max
Sleep mode	0.30 W max

# Physical Characteristics

If you need to clean the module, wipe it with a dry towel.



**Tip** For two-dimensional drawings and three-dimensional models of the C Series module and connectors, visit [ni.com/dimensions](https://ni.com/dimensions) and search by module number.

---

Weight 140 g (4.9 oz)

# Safety Voltages

Connect only voltages that are within the following limits:

---

Channel-to-earth ground  $\pm 30$  V maximum, Measurement Category I

---

## Isolation

Channel-to-channel	None
Channel-to-earth ground	None

Measurement Category I is for measurements performed on circuits not directly connected to the electrical distribution system referred to as *MAINS* voltage. *MAINS* is a hazardous live electrical supply system that powers equipment. This category is for measurements of voltages from specially protected secondary circuits. Such voltage measurements include signal levels, special equipment, limited-energy parts of equipment, circuits powered by regulated low-voltage sources, and electronics.



**Caution** Do not connect the NI 9251 with mini XLR to signals or use for measurements within Measurement Categories II, III, or IV.



# Hazardous Locations

U.S. (UL)	Class I, Division 2, Groups A, B, C, D, T4; Class I, Zone 2, AEx nA IIC T4 Gc
Canada (C-UL)	Class I, Division 2, Groups A, B, C, D, T4; Ex nA IIC T4 Gc
Europe (ATEX) and International (IECEX)	Ex nA IIC T4 Gc

## Safety and Hazardous Locations Standards

This product is designed to meet the requirements of the following electrical equipment safety standards for measurement, control, and laboratory use:

- IEC 61010-1, EN 61010-1
- UL 61010-1, CSA 61010-1
- EN 60079-0:2012, EN 60079-15:2010
- IEC 60079-0: Ed 6, IEC 60079-15; Ed 4
- UL 60079-0; Ed 6, UL 60079-15; Ed 4
- CSA 60079-0:2011, CSA 60079-15:2012



**Note** For UL and other safety certifications, refer to the product label or the [Online Product Certification](#) section.

## Electromagnetic Compatibility

This product meets the requirements of the following EMC standards for electrical equipment for measurement, control, and laboratory use:

- EN 61326-1 (IEC 61326-1): Class A emissions; Industrial immunity
- EN 55011 (CISPR 11): Group 1, Class A emissions
- EN 55022 (CISPR 22): Class A emissions
- EN 55024 (CISPR 24): Immunity
- AS/NZS CISPR 11: Group 1, Class A emissions
- AS/NZS CISPR 22: Class A emissions
- FCC 47 CFR Part 15B: Class A emissions
- ICES-001: Class A emissions



**Note** In the United States (per FCC 47 CFR), Class A equipment is intended for use in commercial, light-industrial, and heavy-industrial locations. In Europe, Canada, Australia and New Zealand (per CISPR 11) Class A equipment is intended for use only in heavy-industrial locations.



**Note** Group 1 equipment (per CISPR 11) is any industrial, scientific, or medical equipment that does not intentionally generate radio frequency energy for the treatment of material or inspection/analysis purposes.



**Note** For EMC declarations and certifications, and additional information, refer to the [Online Product Certification](#) section.

## CE Compliance

This product meets the essential requirements of applicable European Directives, as follows:

- 2014/35/EU; Low-Voltage Directive (safety)
- 2014/30/EU; Electromagnetic Compatibility Directive (EMC)
- 2014/34/EU; Potentially Explosive Atmospheres (ATEX)

## Online Product Certification

Refer to the product Declaration of Conformity (DoC) for additional regulatory compliance information. To obtain product certifications and the DoC for this product, visit [ni.com/certification](http://ni.com/certification), search by model number or product line, and click the appropriate link in the Certification column.

## Shock and Vibration

To meet these specifications, you must panel mount the system.

### Operating vibration

Random (IEC 60068-2-64)	5 g <sub>rms</sub> , 10 Hz to 500 Hz
Sinusoidal (IEC 60068-2-6)	5 g, 10 Hz to 500 Hz
Operating shock (IEC 60068-2-27)	30 g, 11 ms half sine; 50 g, 3 ms half sine; 18 shocks at 6 orientations

## Environmental

Refer to the manual for the chassis you are using for more information about meeting these specifications.

Operating temperature (IEC 60068-2-1, IEC 60068-2-2)	-40 °C to 70 °C
Storage temperature (IEC 60068-2-1, IEC 60068-2-2)	-40 °C to 85 °C
Ingress protection (with power plug attached)	IP 40
Operating humidity (IEC 60068-2-78)	10% RH to 90% RH, noncondensing
Storage humidity (IEC 60068-2-78)	5% RH to 95% RH, noncondensing
Pollution Degree	2
Maximum altitude	5,000 m

Indoor use only.

# Environmental Management

NI is committed to designing and manufacturing products in an environmentally responsible manner. NI recognizes that eliminating certain hazardous substances from our products is beneficial to the environment and to NI customers.

For additional environmental information, refer to the *Minimize Our Environmental Impact* web page at [ni.com/environment](http://ni.com/environment). This page contains the environmental regulations and directives with which NI complies, as well as other environmental information not included in this document.

## Waste Electrical and Electronic Equipment (WEEE)



**EU Customers** At the end of the product life cycle, all NI products must be disposed of according to local laws and regulations. For more information about how to recycle NI products in your region, visit [ni.com/environment/weee](http://ni.com/environment/weee).

## 电子信息产品污染控制管理办法（中国 RoHS）



**中国客户** National Instruments 符合中国电子信息产品中限制使用某些有害物质指令 (RoHS)。关于 National Instruments 中国 RoHS 合规性信息，请登录 [ni.com/environment/rohs\\_china](http://ni.com/environment/rohs_china)。(For information about China RoHS compliance, go to [ni.com/environment/rohs\\_china](http://ni.com/environment/rohs_china).)

## Calibration

You can obtain the calibration certificate and information about calibration services for the NI 9251 with mini XLR at [ni.com/calibration](http://ni.com/calibration).

Calibration interval 2 years

---

Refer to the *NI Trademarks and Logo Guidelines* at [ni.com/trademarks](http://ni.com/trademarks) for information on NI trademarks. Other product and company names mentioned herein are trademarks or trade names of their respective companies. For patents covering NI products/technology, refer to the appropriate location: **Help»Patents** in your software, the `patents.txt` file on your media, or the *National Instruments Patent Notice* at [ni.com/patents](http://ni.com/patents). You can find information about end-user license agreements (EULAs) and third-party legal notices in the readme file for your NI product. Refer to the *Export Compliance Information* at [ni.com/legal/export-compliance](http://ni.com/legal/export-compliance) for the NI global trade compliance policy and how to obtain relevant HTS codes, ECCNs, and other import/export data. NI MAKES NO EXPRESS OR IMPLIED WARRANTIES AS TO THE ACCURACY OF THE INFORMATION CONTAINED HEREIN AND SHALL NOT BE LIABLE FOR ANY ERRORS. U.S. Government Customers: The data contained in this manual was developed at private expense and is subject to the applicable limited rights and restricted data rights as set forth in FAR 52.227-14, DFAR 252.227-7014, and DFAR 252.227-7015.

© 2015—2016 National Instruments. All rights reserved.

376359B-02 Nov16