

## COMPREHENSIVE SERVICES

We offer competitive repair and calibration services, as well as easily accessible documentation and free downloadable resources.

## SELL YOUR SURPLUS

We buy new, used, decommissioned, and surplus parts from every NI series. We work out the best solution to suit your individual needs.

 Sell For Cash    Get Credit    Receive a Trade-In Deal

## OBSOLETE NI HARDWARE IN STOCK & READY TO SHIP

We stock **New**, **New Surplus**, **Refurbished**, and **Reconditioned** NI Hardware.



*Bridging the gap between the manufacturer and your legacy test system.*

 1-800-915-6216

 [www.apexwaves.com](http://www.apexwaves.com)

 [sales@apexwaves.com](mailto:sales@apexwaves.com)

*All trademarks, brands, and brand names are the property of their respective owners.*

**Request a Quote**

 **CLICK HERE**

**NI-9375**

## DATASHEET

# NI 9375

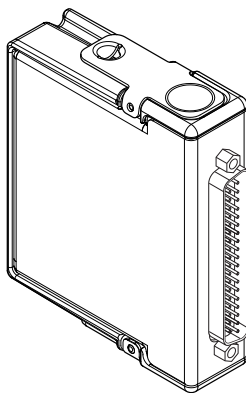
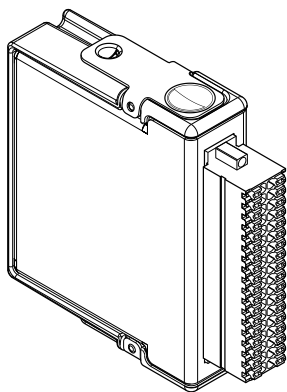

30 V DC, 16 DI/16 DO, 7  $\mu$ s Sinking DI, 500  $\mu$ s Sourcing DO C Series Digital Module



- DSUB or push-in style spring terminal connectivity
- 60 V DC, DI-bank-to-DO-bank isolation
- 60 V DC, CAT I, channel-to-earth isolation

The NI 9375 is a combination digital input, digital output module for CompactDAQ and CompactRIO systems. The digital input lines are compatible with 24 V logic levels and the digital output lines are compatible with 6 V to 30 V signals, based on the external power supply. It works with industrial logic levels and signals for direct connection to a wide array of industrial switches, transducers, and other devices.

In this document, the NI 9375 with spring terminal and the NI 9375 with DSUB are referred to inclusively as the NI 9375. This document contains information for the push-in type NI 9375 with spring terminal model.

 <p>Kit Contents</p>	<ul style="list-style-type: none"><li>• NI 9375</li><li>• NI 9375 Getting Started Guide</li></ul>
 <p>Accessories</p>	<ul style="list-style-type: none"><li>• NI 9940 Backshell Connector Kit (Spring Terminal)</li><li>• NI 9923 Screw-Terminal Block (DSUB)</li></ul>

# NI C Series Overview

---



NI provides more than 100 C Series modules for measurement, control, and communication applications. C Series modules can connect to any sensor or bus and allow for high-accuracy measurements that meet the demands of advanced data acquisition and control applications.

- Measurement-specific signal conditioning that connects to an array of sensors and signals
- Isolation options such as bank-to-bank, channel-to-channel, and channel-to-earth ground
- -40 °C to 70 °C temperature range to meet a variety of application and environmental needs
- Hot-swappable

The majority of C Series modules are supported in both CompactRIO and CompactDAQ platforms and you can move modules from one platform to the other with no modification.

## CompactRIO



CompactRIO combines an open-embedded architecture with small size, extreme ruggedness, and C Series modules in a platform powered by the NI LabVIEW reconfigurable I/O (RIO) architecture. Each system contains an FPGA for custom timing, triggering, and processing with a wide array of available modular I/O to meet any embedded application requirement.

## CompactDAQ

CompactDAQ is a portable, rugged data acquisition platform that integrates connectivity, data acquisition, and signal conditioning into modular I/O for directly interfacing to any sensor or signal. Using CompactDAQ with LabVIEW, you can easily customize how you acquire, analyze, visualize, and manage your measurement data.



# Software

## LabVIEW Professional Development System for Windows



- Use advanced software tools for large project development
- Generate code automatically using DAQ Assistant and Instrument I/O Assistant
- Use advanced measurement analysis and digital signal processing
- Take advantage of open connectivity with DLLs, ActiveX, and .NET objects
- Build DLLs, executables, and MSI installers

## NI LabVIEW FPGA Module

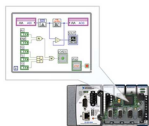

- Design FPGA applications for NI RIO hardware
- Program with the same graphical environment used for desktop and real-time applications
- Execute control algorithms with loop rates up to 300 MHz
- Implement custom timing and triggering logic, digital protocols, and DSP algorithms
- Incorporate existing HDL code and third-party IP including Xilinx IP generator functions
- Purchase as part of the LabVIEW Embedded Control and Monitoring Suite

## NI LabVIEW Real-Time Module

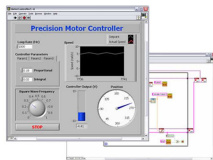

- Design deterministic real-time applications with LabVIEW graphical programming
- Download to dedicated NI or third-party hardware for reliable execution and a wide selection of I/O
- Take advantage of built-in PID control, signal processing, and analysis functions
- Automatically take advantage of multicore CPUs or set processor affinity manually
- Take advantage of real-time OS, development and debugging support, and board support
- Purchase individually or as part of a LabVIEW suite

# NI 9375 Circuitry

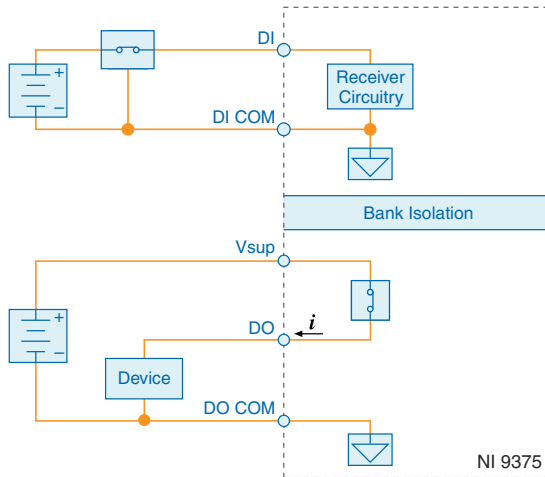

- The bank of 16 digital input channels and the bank of 16 digital output channels on the NI 9375 are isolated from each other and isolated from earth ground.
- The NI 9375 internally limits current signals connected to DI.
- The NI 9375 has sinking inputs. Sinking inputs provide a path to COM when the sourcing device connected to the NI 9375 drives current or applies voltage to DI.
- The NI 9375 has sourcing outputs. Sourcing outputs drive current from Vsup to DO when the channel is on.



**Tip** For more information about sinking inputs and sourcing outputs, visit [ni.com/r/sinksources](https://ni.com/r/sinksources).

## Allowable Current Per Module

The NI 9375 has a per module continuous output current specification. Use the following equation to determine whether the total module current of your loads for channels that are turned on are within the specification.

**Figure 1. Total Module Current Equation**

$$(I_{D00})^2 + (I_{D01})^2 + \dots + (I_{D015})^2 = \text{Total Module Current}$$

For example, an NI 9375 with spring terminal with two channels at 250 mA, six channels at 125 mA, and eight channels at 62 mA has the following per module continuous output current.

**Figure 2. Total Module Current Example**

$$\left\{ \left[ (250 \text{ mA})^2 * 2 \right] + \left[ (125 \text{ mA})^2 * 6 \right] + \left[ (62 \text{ mA})^2 * 8 \right] \right\} = 0.25 \text{ A}^2$$

## NI 9375 Specifications

The following specifications are typical for the range -40 °C to 70 °C unless otherwise noted. All voltages are relative to COM unless otherwise noted.



**Caution** Do not operate the NI 9375 in a manner not specified in this document. Product misuse can result in a hazard. You can compromise the safety protection built into the product if the product is damaged in any way. If the product is damaged, return it to NI for repair.

## Input/Output Characteristics

Number of channels	32 channels: 16 digital input and 16 digital output
--------------------	---

### Digital Input

Input type	Sinking
Input voltage range	0 VDC to 30 VDC
Digital logic levels	
OFF state	
Input voltage	≤5 V
Input current	≤150 μA
ON state	
Input voltage	≥10 V
Input current	≥330 μA
Hysteresis	
Input voltage	1.7 V minimum
Input current	50 μA minimum
Input impedance	30 kΩ ±5%

Setup time <sup>1</sup>	1 $\mu$ s maximum
Update/transfer time <sup>2</sup>	7 $\mu$ s maximum

## Digital Output

Output type	Sourcing
Power-on output state	Channels off
External power supply voltage range (V <sub>sup</sub> )	6 VDC to 30 VDC
Continuous output current ( $I_O$ )	
NI 9375 with spring terminal	
All channels on	125 mA maximum (per channel)
One channel on	500 mA maximum
Per module	0.25 A <sup>2</sup>
NI 9375 with DSUB	
All channels on	100 mA maximum (per channel)
One channel on	400 mA maximum
Per module	0.16 A <sup>2</sup> maximum
Output impedance ( $R_O$ )	0.3 $\Omega$ maximum
Output voltage ( $V_O$ )	V <sub>sup</sub> - ( $I_O R_O$ )
Reversed-voltage protection	None
Current limiting	None
V <sub>sup</sub> current consumption	18 mA
Update/transfer time <sup>3</sup>	7 $\mu$ s maximum
Propagation delay <sup>4</sup>	500 $\mu$ s maximum

### Related Information

[Allowable Current Per Module](#) on page 4

- <sup>1</sup> *Setup time* is the amount of time input signals must be stable before reading from the module.
- <sup>2</sup> *Update/transfer time* is the maximum time the software takes to read data from the module. The update/transfer is valid when the module is used in a CompactRIO system. When used in other systems, driver software and system latencies impact this time.
- <sup>3</sup> *Update/transfer time* is the maximum time the software takes to write data to the module. The update/transfer is valid when the module is used in a CompactRIO system. When used in other systems, driver software and system latencies impact this time.
- <sup>4</sup> *Propagation delay* is the amount of time it takes the output signals to change state after being written to.

# Power Requirements

## Power consumption from chassis

Active mode	450 mW maximum
Sleep mode	25 $\mu$ W maximum

## Thermal dissipation (at 70 °C)

Active mode	1.5 W maximum
Sleep mode	0.6 W maximum

# Physical Characteristics

## Spring terminal wiring

Gauge	0.14 mm <sup>2</sup> to 1.5 mm <sup>2</sup> (26 AWG to 16 AWG) copper conductor wire
Wire strip length	10 mm (0.394 in.) of insulation stripped from the end
Temperature rating	90 °C, minimum
Wires per spring terminal	One wire per spring terminal; two wires per spring terminal using a 2-wire ferrule

## Ferrules

Single ferrule, uninsulated	0.13 mm <sup>2</sup> to 1.5 mm <sup>2</sup> (26 AWG to 16 AWG) 10 mm barrel length
Single ferrule, insulated	0.13 mm <sup>2</sup> to 1.0 mm <sup>2</sup> (26 AWG to 18 AWG) 12 mm barrel length
Two-wire ferrule, insulated	2x 0.34 mm <sup>2</sup> (2x 22 AWG) 12 mm barrel length

## Connector securement

Securement type	Screw flanges provided
Torque for screw flanges	0.2 N · m (1.80 lb · in.)

## Weight

NI 9375 with spring terminal	164 g (5.8 oz)
NI 9375 with DSUB	148 g (5.3 oz)



**Tip** For two-dimensional drawings and three-dimensional models of the C Series module and connectors, visit [ni.com/dimensions](https://ni.com/dimensions) and search by module number.



# NI 9375 Safety Voltages

Connect only voltages that are within the following limits:

Channel-to-COM or $V_{sup}$ -to-COM	30 V DC maximum
Isolation	
DI bank-to-DO bank	60 V DC maximum
Channel-to-Channel	No isolation between channels
Channel-to-earth ground	
Continuous	60 V DC, Measurement Category I
Withstand up to 3,000 m	1,000 V RMS, verified by a 5 s dielectric withstand test
Withstand up to 5,000 m	860 V RMS

Measurement Category I is for measurements performed on circuits not directly connected to the electrical distribution system referred to as *MAINS* voltage. MAINS is a hazardous live electrical supply system that powers equipment. This category is for measurements of voltages from specially protected secondary circuits. Such voltage measurements include signal levels, special equipment, limited-energy parts of equipment, circuits powered by regulated low-voltage sources, and electronics.



**Note** Measurement Categories CAT I and CAT O are equivalent. These test and measurement circuits are for other circuits not intended for direct connection to the MAINS building installations of Measurement Categories CAT II, CAT III, or CAT IV.



**Caution** Do not connect the NI 9375 to signals or use for measurements within Measurement Categories II, III, or IV.



**Attention** Ne connectez pas le NI 9375 à des signaux et ne l'utilisez pas pour effectuer des mesures dans les catégories de mesure II, III ou IV.

## Safety Guidelines for Hazardous Locations

Follow these guidelines if you are installing the device in a potentially explosive environment. The device has been evaluated as compliant with the ATEX directive and is IECEx certified. Each device is marked  II 3G and is suitable for use in Zone 2 hazardous locations, in

ambient temperatures of  $-40\text{ °C} \leq T_a \leq 70\text{ °C}$ . The device is suitable for use in non-hazardous locations and the following hazardous locations.

U.S. (UL)	Class I, Division 2, Groups A, B, C, D, T4; Class I, Zone 2, AEx nA IIC T4
Canada (C-UL)	Class I, Division 2, Groups A, B, C, D, T4; Ex nA IIC T4
Europe (ATEX) and International (IECEX)	Ex nA IIC T4 Gc; DEMKO 07 ATEX 0626664X; IECEx UL 14.0089X

## Safety Compliance and Hazardous Locations Standards

This product is designed to meet the requirements of the following electrical equipment safety standards for measurement, control, and laboratory use:

- IEC 61010-1, EN 61010-1
- UL 61010-1, CSA C22.2 No. 61010-1
- EN 60079-0: Ed 5, EN 60079-15: Ed 4
- IEC 60079-0: Ed 6, IEC 60079-15; Ed 4
- UL 60079-0; Ed 6, UL 60079-15; Ed 4
- CSA C22.2 No. 60079-0, CSA C22.2 No. 60079-15



**Note** For UL and other safety certifications, refer to the product label or the [Product Certifications and Declarations](#) section.

## Electromagnetic Compatibility Standards

This product meets the requirements of the following EMC standards for electrical equipment for measurement, control, and laboratory use:

- EN 61326-1 (IEC 61326-1): Class A emissions; Industrial immunity
- EN 55011 (CISPR 11): Group 1, Class A emissions
- AS/NZS CISPR 11: Group 1, Class A emissions



**Note** Group 1 equipment (per CISPR 11) is any industrial, scientific, or medical equipment that does not intentionally generate radio frequency energy for the treatment of material or inspection/analysis purposes.



**Note** In Europe, Australia, and New Zealand (per CISPR 11) Class A equipment is intended for use in non-residential locations.

# Environmental Characteristics

## Temperature and Humidity

Temperature	
Operating	-40 °C to 70 °C
Storage	-40 °C to 85 °C
Humidity	
Operating	10% RH to 90% RH, noncondensing
Storage	5% RH to 95% RH, noncondensing
Ingress protection	IP40
Pollution Degree	2
Maximum altitude	5,000 m

## Shock and Vibration

Operating vibration	
Random	5 g RMS, 10 Hz to 500 Hz
Sinusoidal	5 g, 10 Hz to 500 Hz
Operating shock	30 g, 11 ms half sine; 50 g, 3 ms half sine; 18 shocks at 6 orientations

## Environmental Standards

This product meets the requirements of the following environmental standards for electrical equipment.

- IEC 60068-2-1 Cold
- IEC 60068-2-2 Dry heat
- IEC 60068-2-30 Damp heat cyclic (12 + 12h cycle)
- IEC 60068-2-64 Random operating vibration
- IEC 60068-2-6 Sinusoidal operating vibration
- IEC 60068-2-27 Operating shock



**Note** To verify marine approval certification for a product, refer to the product label or visit [ni.com/certification](https://ni.com/certification) and search for the certificate.

# CE Compliance

This product meets the essential requirements of applicable European Directives, as follows:

- 2014/30/EU; Electromagnetic Compatibility Directive (EMC)
- 2011/65/EU; Restriction of Hazardous Substances (RoHS)
- 2014/34/EU; Potentially Explosive Atmospheres (ATEX)

## Product Certifications and Declarations

Refer to the product Declaration of Conformity (DoC) for additional regulatory compliance information. To obtain product certifications and the DoC for NI products, visit [ni.com/product-certifications](https://ni.com/product-certifications), search by model number, and click the appropriate link.

## Environmental Management

NI is committed to designing and manufacturing products in an environmentally responsible manner. NI recognizes that eliminating certain hazardous substances from our products is beneficial to the environment and to NI customers.

For additional environmental information, refer to the *Commitment to the Environment* web page at [ni.com/environment](https://ni.com/environment). This page contains the environmental regulations and directives with which NI complies, as well as other environmental information not included in this document.

## Waste Electrical and Electronic Equipment (WEEE)



**EU Customers** At the end of the product life cycle, all NI products must be disposed of according to local laws and regulations. For more information about how to recycle NI products in your region, visit [ni.com/environment/weee](https://ni.com/environment/weee).

## 电子信息产品污染控制管理办法（中国 RoHS）



**中国客户** National Instruments 符合中国电子信息产品中限制使用某些有害物质指令 (RoHS)。关于 National Instruments 中国 RoHS 合规性信息，请登录 [ni.com/environment/rohs\\_china](https://ni.com/environment/rohs_china)。(For information about China RoHS compliance, go to [ni.com/environment/rohs\\_china](https://ni.com/environment/rohs_china).)

Information is subject to change without notice. Refer to the *NI Trademarks and Logo Guidelines* at [ni.com/trademarks](http://ni.com/trademarks) for information on NI trademarks. Other product and company names mentioned herein are trademarks or trade names of their respective companies. For patents covering NI products/technology, refer to the appropriate location: **Help»Patents** in your software, the `patents.txt` file on your media, or the *National Instruments Patent Notice* at [ni.com/patents](http://ni.com/patents). You can find information about end-user license agreements (EULAs) and third-party legal notices in the `readme` file for your NI product. Refer to the *Export Compliance Information* at [ni.com/legal/export-compliance](http://ni.com/legal/export-compliance) for the NI global trade compliance policy and how to obtain relevant HTS codes, ECCNs, and other import/export data. NI MAKES NO EXPRESS OR IMPLIED WARRANTIES AS TO THE ACCURACY OF THE INFORMATION CONTAINED HEREIN AND SHALL NOT BE LIABLE FOR ANY ERRORS. U.S. Government Customers: The data contained in this manual was developed at private expense and is subject to the applicable limited rights and restricted data rights as set forth in FAR 52.227-14, DFAR 252.227-7014, and DFAR 252.227-7015.

© 2017—2020 National Instruments. All rights reserved.

378026B-02 March 18, 2020