

COMPREHENSIVE SERVICES

We offer competitive repair and calibration services, as well as easily accessible documentation and free downloadable resources.

SELL YOUR SURPLUS

We buy new, used, decommissioned, and surplus parts from every NI series. We work out the best solution to suit your individual needs.

 Sell For Cash  Get Credit  Receive a Trade-In Deal

OBSOLETE NI HARDWARE IN STOCK & READY TO SHIP

We stock **New**, **New Surplus**, **Refurbished**, and **Reconditioned** NI Hardware.



Bridging the gap between the manufacturer and your legacy test system.

 1-800-915-6216

 www.apexwaves.com

 sales@apexwaves.com

All trademarks, brands, and brand names are the property of their respective owners.

Request a Quote

 **CLICK HERE**

NI-9437

DATASHEET

NI 9437

8-Channel, 250 V Sinking Digital Input Module



- 8-channel, 1 μ s digital input
- 24 V to 250 V logic, sinking digital input
- Ratiometric thresholds that automatically adjusts to 2/3 of the DC supply voltage
- Compatible with NI CompactDAQ counters
- 300 V_{rms} CAT II isolation
- -40 °C to 70 °C operating, 5 g vibration, 50 g shock

The NI 9437 is an 8-channel, 1 μ s sinking digital input module for NI CompactDAQ and NI CompactRIO chassis and controllers. The NI 9437 is compatible with 24 V to 250 V signals and features a ratiometric threshold that automatically adjusts to 2/3 of the supply voltage. This ratiometric threshold helps protect from noisy signals at any measurement range. The NI 9437 is well suited for direct connection in Rail (72 V, 96 V, 110 V) and Power (110 V, 125 V, 220 V, 250 V) applications along with a wide array of industrial and automotive switches, transducers, and devices with high voltage inputs requirements.

NI 9437 KIT CONTENTS

NI 9437 & NI 9936



NI 9437 Getting Started Guide



NI 9437 RECOMMENDED ACCESSORY

NI 9932 Strain Relief and Operator Protection Backshell



C SERIES DIGITAL INPUT MODULE COMPARISON

Module	Signal Ranges	Channels	Update Time	Direction	Connectivity	Isolation
NI 9375	24 V	16 Input, 16 Output	7 μ s Input, 500 μ s Output	Sinking Input, Sourcing Output	Screw Terminal, DSUB	CH-Earth: 60 VDC
NI 9411	5 V, 24 V	6 Input	0.5 μ s	Sinking/Sourcing DIFF/SE Input	DSUB	CH-Earth: 60 VDC
NI 9421	24 V	8 Input	100 μ s	Sinking Input	Screw Terminal, DSUB	Ch-Earth: 250 Vrms (Screw Terminal), 60 VDC (DSUB)
NI 9422	24 V, 48 V	8 Input	250 μ s	Sinking/Sourcing Input	Screw Terminal	CH-CH: 250 Vrms
NI 9423	24 V	8 Input	1 μ s	Sinking Input	Screw Terminal	CH-Earth: 250 Vrms
NI 9425	24 V	32 Input	7 μ s	Sinking Input	DSUB	CH-Earth: 60 VDC
NI 9426	24 V	32 Input	7 μ s	Sourcing Input	DSUB	CH-Earth: 60 VDC
NI 9435	250 VDC/ VAC	4 Input	3000 μ s	Sinking/Sourcing Input	Screw Terminal	CH-CH: 250 Vrms
NI 9437	24 V to 250 V	8 Input	1 μ s	Sinking Input	Screw Terminal	CH-Earth: 300 Vrms

NI C Series Overview



NI provides more than 100 C Series modules for measurement, control, and communication applications. C Series modules can connect to any sensor or bus and allow for high-accuracy measurements that meet the demands of advanced data acquisition and control applications.

- Measurement-specific signal conditioning that connects to an array of sensors and signals
- Isolation options such as bank-to-bank, channel-to-channel, and channel-to-earth ground
- -40 °C to 70 °C temperature range to meet a variety of application and environmental needs
- Hot-swappable

The majority of C Series modules are supported in both NI CompactRIO and NI CompactDAQ platforms and you can move modules from one platform to the other with no modification.

CompactRIO



CompactRIO combines an open-embedded architecture with small size, extreme ruggedness, and C Series modules in a platform powered by the NI LabVIEW reconfigurable I/O (RIO) architecture. Each system contains a FPGA for custom timing, triggering, and processing with a wide array of available modular I/O to meet any embedded application requirement.

CompactDAQ

CompactDAQ is a portable, rugged data acquisition platform that integrates connectivity, data acquisition, and signal conditioning into modular I/O for directly interfacing to any sensor or signal. Using CompactDAQ with LabVIEW, you can easily customize how you acquire, analyze, visualize, and manage your measurement data.



Software

LabVIEW Professional Development System for Windows

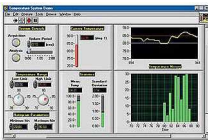

- Use advanced software tools for large project development
- Generate code automatically using DAQ Assistant and Instrument I/O Assistant
- Use advanced measurement analysis and digital signal processing
- Take advantage of open connectivity with DLLs, ActiveX, and .NET objects
- Build DLLs, executables, and MSI installers

NI LabVIEW FPGA Module



- Design FPGA applications for NI RIO hardware
- Program with the same graphical environment used for desktop and real-time applications
- Execute control algorithms with loop rates up to 300 MHz
- Implement custom timing and triggering logic, digital protocols, and DSP algorithms
- Incorporate existing HDL code and third-party IP including Xilinx CORE Generator functions
- Purchase as part of the LabVIEW Embedded Control and Monitoring Suite

NI LabVIEW Real-Time Module

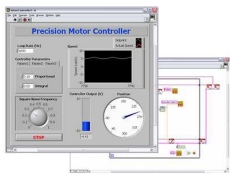

- Design deterministic real-time applications with LabVIEW graphical programming
- Download to dedicated NI or third-party hardware for reliable execution and a wide selection of I/O
- Take advantage of built-in PID control, signal processing, and analysis functions
- Automatically take advantage of multicore CPUs or set processor affinity manually
- Take advantage of real-time OS, development and debugging support, and board support
- Purchase individually or as part of a LabVIEW suite

NI 9437 Theory of Operation

The NI 9437 inputs use an adjustable threshold that is determined by the input voltage on the NI 9437 V_{SUP} pin. The threshold is nominally $2/3$ of the input voltage and the NI 9437 reads ON or OFF if the voltage on the channel is above or below the threshold voltage. This allows you to input voltages ranging from 24 V to 250 V. The 8 digital input channels on the NI 9437 share the same V_{SUP} terminal, so all eight channels must use the same V_{SUP} threshold.

The NI 9437 isolation allows you to connect floating power supplies, split-rail power supplies, and grounded power supplies to the NI 9437, shown in Figure 1. The 9437 provides channel-to-earth ground, V_{SUP} -to-earth ground, and COM-to-earth ground isolation. Refer to the [Specifications](#) section of this document for more information about isolation.

Figure 1. Power Supply Connections to the NI 9437

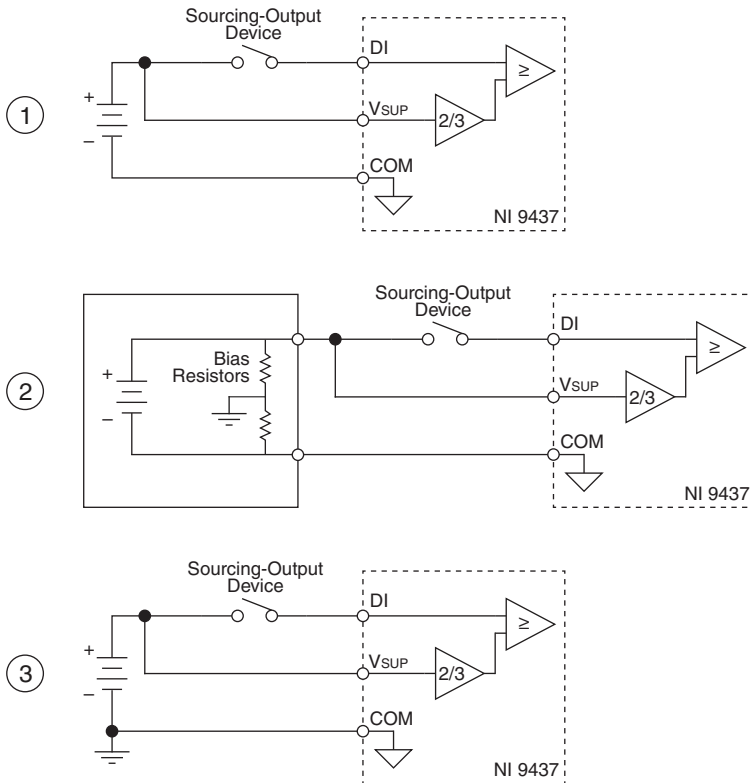

- 1 Floating Power Supply—a power supply that does not have either terminal connected to ground.
- 2 Split-Rail Power Supply—a floating power supply that is weakly centered around earth ground using bias resistors.
- 3 Grounded Power Supply—a power supply that is connected to earth ground for normal operation.

Ground-Fault Protection

When using a floating or split-rail power supply, the NI 9437 can tolerate a single ground fault from V_{SUP} -to-earth ground, COM-to-earth ground, or DI-to-earth ground.

- V_{SUP} -to-earth ground or COM-to-earth ground—the NI 9437 can tolerate a single ground fault from V_{SUP} -to-earth ground or COM-to-earth ground because of the isolation of the module
- DI-to-earth ground—the NI 9437 can tolerate a single ground fault from DI-to-earth ground because the threshold reference is $2/3$ the supply voltage on the V_{SUP} pin.

With any one pin— V_{SUP} , COM, or a single DI—shorted to earth ground, the NI 9437 operates normally and returns valid data.



Note When using a grounded power supply, there is always a connection between COM and earth ground and you will not have protection against ground faults from V_{SUP} -to-earth ground or from DI-to-earth ground.

Burden Current

The NI 9437 inputs have a burden current over the input voltage range. At lower input voltages, the current is approximately constant. At higher input voltages, the power is approximately constant. The NI 9437 burden current:

- Discharges any capacitance that may be present on the input when no signal is present or the sourcing-output device is open, giving the NI 9437 immunity to capacitively coupled transients when debounced using a time at least as large as the turn-off time.
- Sets the turn-off time based on the discharge of capacitance when the signal is removed or the sourcing-output device is opening.
- Sinks leakage current when devices connected to the inputs are open, disconnected, or at high impedance.
- Provides a wetting current when closing dry-contact sourcing-output devices.

The following figures show the maximum and minimum burden current per channel that the NI 9437 presents to a connected load in mA and mW. Refer to the [Specifications](#) section of this document for more information about the NI 9437 input current and input power.

Figure 2. Burden Current Per Channel

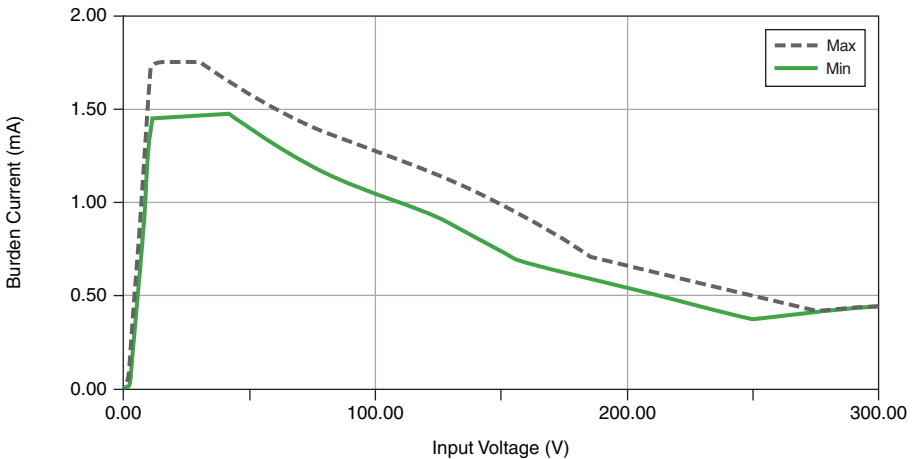
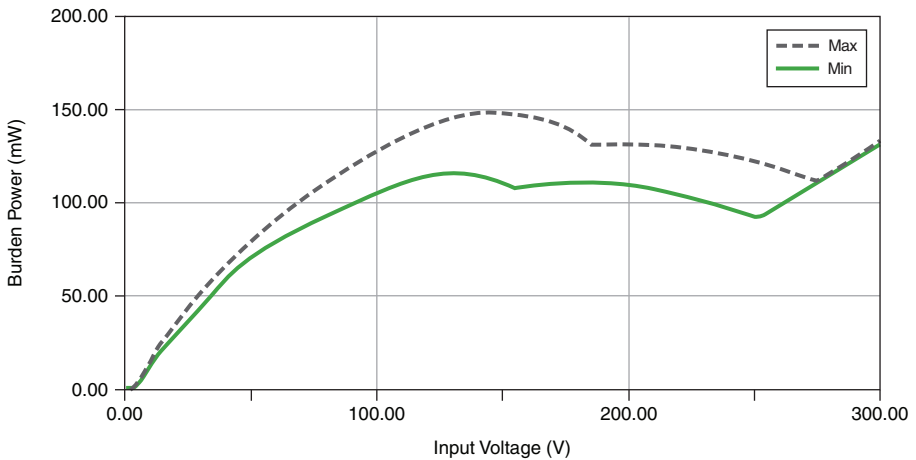

Figure 3. Burden Power Per Channel



Turn-Off Time

The NI 9437 turn-off time is the amount of time it takes the burden current of the digital input to discharge any capacitance on the input line to a voltage below the $\frac{2}{3} V_{SUP}$ threshold level when no signal is present or the sourcing-output device is open. When opening the sourcing-output device, the turn-off time is the time it takes for the NI 9437 to read the incoming voltage as OFF.



Note The NI 9437 turn-on time is the amount of time it takes the input voltage to cross the $\frac{2}{3} V_{SUP}$ threshold plus the input delay time of the NI 9437. Refer to the [Specifications](#) section of this document for more information about the NI 9437 input delay time.

The NI 9437 provides sinking digital inputs that discharge capacitance that might be present on the input line, as shown in Figure 4. If there are transients that could charge this capacitance to the value of the supply voltage, the turn-off time is the amount of time it takes for the NI 9437 to remove this charge to a level below the threshold voltage. When you debounce your readings from the NI 9437 in your software application with a debounce time that is at least as long as this turn-off time, the NI 9437 is immune to these capacitively coupled transients.

Figure 4. Capacitance Discharge

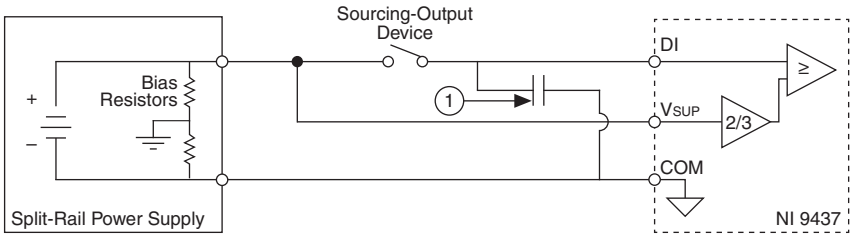

1 Capacitance from cables, sensors and so on.

Use the following equation to determine the correct turn-off time over the full temperature range based on the supply voltage and the amount of capacitance in your system.

$$T = C \times 3k \times \left(\left(\frac{V}{75} \right)^3 + \frac{V}{15} + 1 \right)$$

where

T is the maximum turn-off time
 C is the capacitance in your system
 V is the supply voltage

The following graph shows the maximum turn-off time needed for different capacitances and supply voltages.

Figure 5. NI 9437 Turn-Off Time

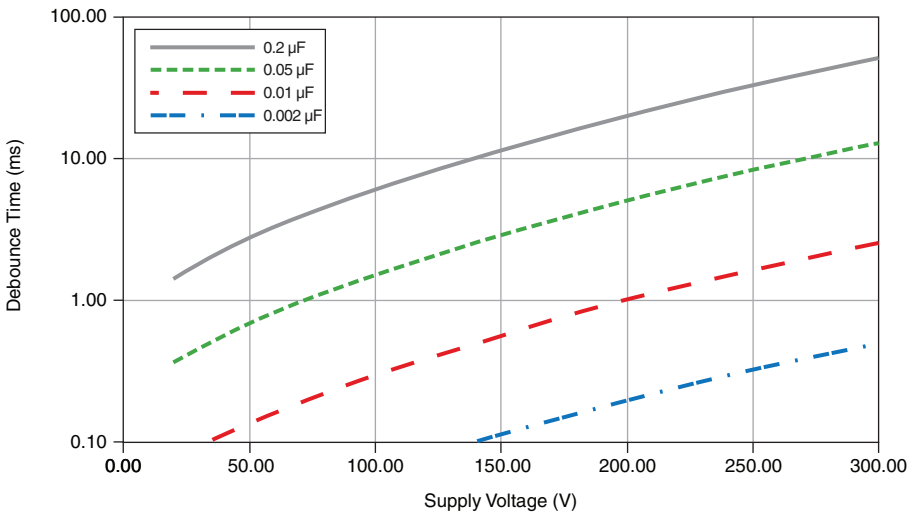

Use the following equation to determine the maximum capacitance that your system can tolerate based on the supply voltage and desired turn-off time.

$$C = \frac{T}{3k \times \left(\left(\frac{V}{75} \right)^3 + \frac{V}{15} + 1 \right)}$$

where

C is the maximum capacitance

T is the desired turn-off time

V is the supply voltage

The following graph shows the maximum capacitance for different turn-off times and supply voltages.

Figure 6. NI 9437 Capacitance Tolerance

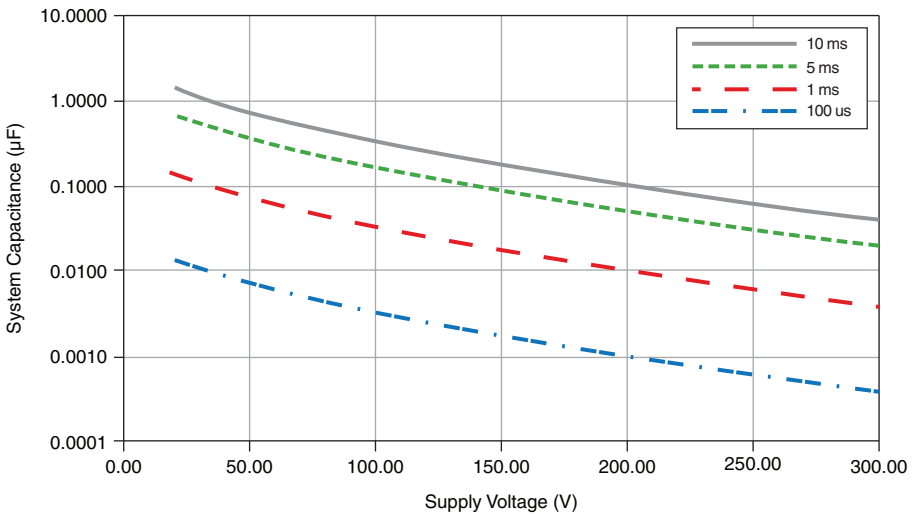

Note For immunity to capacitively coupled transients, use a debounce time that is at least as long as the NI 9437 turn-off time.

Specifications

The following specifications are typical for the range -40 °C to 70 °C unless otherwise noted.



Hot Surface This icon denotes that the component may be hot. Touching this component may result in bodily injury.



Caution Do not operate the NI 9437 in a manner not specified in this manual. Product misuse can result in a hazard. You can compromise the safety protection built into the product if the product is damaged in any way. If the product is damaged, return it to National Instruments for repair.

Input

Number of channels 8 digital input channels

Input type Sinking

Input voltage thresholds

OFF state

24 V to 250 V $65\% * V_{SUP} - 4 \text{ V}$

ON state

24 V to 250 V $73\% * V_{SUP} - 0.75 \text{ V}$

Input current ($10 \text{ V} \leq V_{IN} \leq 60 \text{ V}$)¹

Maximum 1.8 mA

Minimum 1.3 mA

Input power ($60 \text{ V} \leq V_{IN} \leq 300 \text{ V}$)¹

Maximum 150 mW

Minimum 75 mW

Input delay time 1 μs max

MTBF Contact NI for Bellcore MTBF or MIL-HDBK-217F specifications.

Power Requirements

Power consumption from chassis

Active mode 235 mW max

Sleep mode 40 μW max

Thermal dissipation (at 70 °C)

Active mode 1.5 W max

Sleep mode 1.25 W max

¹ With input voltages between 10 V and 60 V, the input load (burden) is an approximately constant current. With input voltages between 60 V and 300 V, the input load is an approximately constant power.

Physical Characteristics

If you need to clean the module, wipe it with a dry towel.



Tip For two-dimensional drawings and three-dimensional models of the C Series module and connectors, visit ni.com/dimensions and search by module number.

Screw-terminal wiring

Gauge..... 0.321 mm² (28 AWG) to 1.291 mm² (16 AWG)
copper conductor wire with 6 mm (0.236 in.) of
insulation stripped from the end

Temperature rating..... 80 °C min

Wires per terminal One wire per screw terminal,
two wires per screw terminal using a 2-wire
ferrule

Ferrules 0.2 mm² to 1.5 mm²

Torque for screw terminals 0.4 N · m to 0.5 N · m
(3.5 lb · in. to 4.4 lb · in.)

Connector securement

Securement type Screw flanges provided

Torque for screw flanges 0.2 N · m (1.80 lb · in.)

Weight..... 165 g (5.8 oz)

Safety

Safety Voltages

Connect only voltages that are within the following limits.

Channel-to-COM, V_{SUP}-to-COM 300 VDC max

Isolation

Channel-to-channel..... None

Channel-to-V_{SUP} None

Channel-to-earth ground, V_{SUP}-to-earth ground,
COM-to-earth ground

Continuous..... 300 V_{rms}, Measurement Category II

Withstand..... 3,000 V, verified by a 5 s dielectric
withstand test

Measurement Category II is for measurements performed on circuits directly connected to the electrical distribution system. This category refers to local-level electrical distribution, such as that provided by a standard wall outlet, for example, 115 V for U.S. or 230 V for Europe.



Caution Do *not* connect the NI 9437 to signals or use for measurements within Measurement Categories III or IV.

Safety and Hazardous Locations Standards

This product meets the requirements of the following standards of safety for electrical equipment for measurement, control, and laboratory use:

- IEC 61010-1, EN 61010-1
- UL 61010-1, CSA 61010-1
- EN 60079-0:2012, EN 60079-15:2010
- IEC 60079-0: Ed 6, IEC 60079-15: Ed 4
- UL 60079-0: Ed 5, UL 60079-15: Ed 3
- CSA 60079-0:2011, CSA 60079-15:2012



Note For UL and other safety certifications, refer to the product label or the [Online Product Certification](#) section of this document.

Electromagnetic Compatibility

This product meets the requirements of the following EMC standards for electrical equipment for measurement, control, and laboratory use:

- EN 61326-1 (IEC 61326-1): Class A emissions; Industrial immunity
- EN 55011 (CISPR 11): Group 1, Class A emissions
- EN 55022 (CISPR 22): Class A emissions
- EN 55024 (CISPR 24): Immunity
- AS/NZS CISPR 11: Group 1, Class A emissions
- AS/NZS CISPR 22: Class A emissions
- FCC 47 CFR Part 15B: Class A emissions
- ICES-001: Class A emissions



Note In the United States (per FCC 47 CFR), Class A equipment is intended for use in commercial, light-industrial, and heavy-industrial locations. In Europe, Canada, Australia, and New Zealand (per CISPR 11), Class A equipment is intended for use only in heavy-industrial locations.



Note Group 1 equipment (per CISPR 11) is any industrial, scientific, or medical equipment that does not intentionally generate radio frequency energy for the treatment of material or inspection/analysis purposes.



Note For EMC declarations and certifications, refer to the [Online Product Certification](#) section of this document.

CE Compliance

This product meets the essential requirements of applicable European Directives as follows:

- 2006/95/EC; Low-Voltage Directive (safety)
- 2004/108/EC; Electromagnetic Compatibility Directive (EMC)
- 94/9/EC; Potentially Explosive Atmospheres (ATEX)

Online Product Certification

To obtain product certifications and the Declaration of Conformity (DoC) for this product, visit ni.com/certification, search by module number or product line, and click the appropriate link in the Certification column.

Shock and Vibration

To meet these specifications, you must panel mount the system and either affix ferrules to the ends of the terminal wires or use the NI 9932 backshell kit to protect the connections.

Operating vibration

Random (IEC 60068-2-64) 5 g_{rms}, 10 Hz to 500 Hz

Sinusoidal (IEC 60068-2-6) 5 g, 10 Hz to 500 Hz

Operating shock

(IEC 60068-2-27) 30 g, 11 ms half sine, 50 g, 3 ms half sine,
18 shocks at 6 orientations

Environmental

Refer to the manual for the chassis you are using for more information about meeting these specifications.

Operating temperature

(IEC 60068-2-1, IEC 60068-2-2) -40 °C to 70 °C

Storage temperature

(IEC 60068-2-1, IEC 60068-2-2) -40 °C to 85 °C

Ingress protection IP 40

Operating humidity

(IEC 60068-2-56) 10% to 90% RH,
noncondensing

Storage humidity

(IEC 60068-2-56) 5% to 95% RH,
noncondensing

Pollution Degree 2

Maximum altitude 5,000 m

Indoor use only.

Environmental Management

NI is committed to designing and manufacturing products in an environmentally responsible manner. NI recognizes that eliminating certain hazardous substances from our products is beneficial to the environment and to NI customers.

For additional environmental information, refer to the *Minimize Our Environmental Impact* web page at ni.com/environment. This page contains the environmental regulations and directives with which NI complies, as well as other environmental information not included in this document.

Waste Electrical and Electronic Equipment (WEEE)



EU Customers At the end of the product life cycle, all products *must* be sent to a WEEE recycling center. For more information about WEEE recycling centers, National Instruments WEEE initiatives, and compliance with WEEE Directive 2002/96/EC on Waste and Electronic Equipment, visit ni.com/environment/weee.

电子信息产品污染控制管理办法（中国 RoHS）



中国客户 National Instruments 符合中国电子信息产品中限制使用某些有害物质指令 (RoHS)。关于 National Instruments 中国 RoHS 合规性信息，请登录 ni.com/environment/rohs_china。(For information about China RoHS compliance, go to ni.com/environment/rohs_china.)

Worldwide Support and Services

The National Instruments website is your complete resource for technical support. At ni.com/support you have access to everything from troubleshooting and application development self-help resources to email and phone assistance from NI Application Engineers.

Visit ni.com/services for NI Factory Installation Services, repairs, extended warranty, and other services.

Visit ni.com/register to register your National Instruments product. Product registration facilitates technical support and ensures that you receive important information updates from NI.

A Declaration of Conformity (DoC) is our claim of compliance with the Council of the European Communities using the manufacturer's declaration of conformity. This system affords the user protection for electromagnetic compatibility (EMC) and product safety. You can obtain the DoC for your product by visiting ni.com/certification. If your product supports calibration, you can obtain the calibration certificate for your product at ni.com/calibration.

National Instruments corporate headquarters is located at 11500 North Mopac Expressway, Austin, Texas, 78759-3504. National Instruments also has offices located around the world. For telephone support in the United States, create your service request at ni.com/support or dial 1 866 ASK MYNI (275 6964). For telephone support outside the United States, visit the Worldwide Offices section of ni.com/niglobal to access the branch office websites, which provide up-to-date contact information, support phone numbers, email addresses, and current events.

Refer to the *NI Trademarks and Logo Guidelines* at ni.com/trademarks for more information on National Instruments trademarks. Other product and company names mentioned herein are trademarks or trade names of their respective companies. For patents covering National Instruments products/technology, refer to the appropriate location: **Help»Patents** in your software, the `patents.txt` file on your media, or the *National Instruments Patents Notice* at ni.com/patents. You can find information about end-user license agreements (EULAs) and third-party legal notices in the `readme` file for your NI product. Refer to the *Export Compliance Information* at ni.com/legal/export-compliance for the National Instruments global trade compliance policy and how to obtain relevant HTS codes, ECCNs, and other import/export data. NI MAKES NO EXPRESS OR IMPLIED WARRANTIES AS TO THE ACCURACY OF THE INFORMATION CONTAINED HEREIN AND SHALL NOT BE LIABLE FOR ANY ERRORS. U.S. Government Customers: The data contained in this manual was developed at private expense and is subject to the applicable limited rights and restricted data rights as set forth in FAR 52.227-14, DFAR 252.227-7014, and DFAR 252.227-7015.

© 2014 National Instruments. All rights reserved.