

## COMPREHENSIVE SERVICES

We offer competitive repair and calibration services, as well as easily accessible documentation and free downloadable resources.

## SELL YOUR SURPLUS

We buy new, used, decommissioned, and surplus parts from every NI series. We work out the best solution to suit your individual needs.

 Sell For Cash    Get Credit    Receive a Trade-In Deal

## OBSOLETE NI HARDWARE IN STOCK & READY TO SHIP

We stock **New**, **New Surplus**, **Refurbished**, and **Reconditioned** NI Hardware.



*Bridging the gap between the manufacturer and your legacy test system.*

 1-800-915-6216

 [www.apexwaves.com](http://www.apexwaves.com)

 [sales@apexwaves.com](mailto:sales@apexwaves.com)

*All trademarks, brands, and brand names are the property of their respective owners.*

**Request a Quote**

 **CLICK HERE**

**NI-9505**

# OPERATING INSTRUCTIONS AND SPECIFICATIONS

## NI 9505

### DC Brushed Servo Drive

Français    Deutsch    日本語    한국어    简体中文

[ni.com/manuals](http://ni.com/manuals)

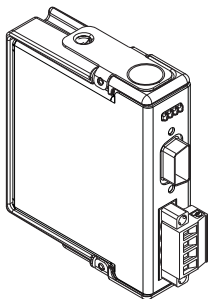

This document describes how to use the National Instruments 9505 module and includes specifications and pin assignments for the NI 9505.



**Note** The safety guidelines and specifications in this document are specific to the NI 9505. The other components in the system may not meet the same safety ratings and specifications. Refer to the documentation for each component in the system to determine the safety ratings and specifications for the entire system.



**Caution** This product may cause radio interference in a domestic environment, in which case supplementary mitigation measures may be required.

## Related Information

---



### NI CompactRIO Documentation

[ni.com/info](http://ni.com/info) ⇨ [cseriesdoc](http://cseriesdoc)



### Chassis Compatibility

[ni.com/info](http://ni.com/info) ⇨ [compatibility](http://compatibility)



### Software Support

[ni.com/info](http://ni.com/info) ⇨ [rdsoftwareversion](http://rdsoftwareversion)



### Services

[ni.com/services](http://ni.com/services)

# Safety Guidelines

---

Operate the NI 9505 only as described in these operating instructions.

## Safety Guidelines for Hazardous Locations

The NI 9505 is suitable for use in Class I, Division 2, Groups A, B, C, D, T4 hazardous locations; Class I, Zone 2, AEx nA IIC T4 and Ex nA IIC T4 hazardous locations; and nonhazardous locations only. Follow these guidelines if you are installing the NI 9505 in a potentially explosive environment. Not following these guidelines may result in serious injury or death.



**Caution** Do not disconnect I/O-side wires or connectors unless power has been switched off or the area is known to be nonhazardous.



**Caution** Do not remove modules unless power has been switched off or the area is known to be nonhazardous.



**Caution** Substitution of components may impair suitability for Class I, Division 2.



**Caution** For Division 2 and Zone 2 applications, install the system in an enclosure rated to at least IP 54 as defined by IEC/EN 60079-15.



**Caution** For Division 2 and Zone 2 applications, install a protection device between the input signal and the Vsup pin. The device must prevent the Vsup-to-channel voltage from exceeding 42 V if there is a transient overvoltage condition.

## Special Conditions for Hazardous Locations Use in Europe and Internationally

This equipment has been evaluated as Ex nA IIC T4 Gc equipment under DEMKO Certificate No. 07 ATEX 0626664X and is IECEx UL 14.0089X certified. Each module is marked  $\text{Ex}$  II 3G and is suitable for use in Zone 2 hazardous locations, in ambient temperatures of  $-40\text{ }^{\circ}\text{C} \leq T_a \leq 70\text{ }^{\circ}\text{C}$ . If you are using the NI 9505 in Gas Group IIC hazardous locations, you must use the device in an NI chassis that has been evaluated as Ex nC IIC T4, Ex IIC T4, Ex nA IIC T4, or Ex nL IIC T4 equipment.



**Caution** You must make sure that transient disturbances do not exceed 140% of the rated voltage.



**Caution** The system shall only be used in an area of not more than Pollution Degree 2, as defined in IEC 60664-1.



**Caution** The system shall be mounted in an ATEX/IECEX-certified enclosure with a minimum ingress protection rating of at least IP54 as defined in IEC/EN 60079-15.



**Caution** The enclosure must have a door or cover accessible only by the use of a tool.

## Electromagnetic Compatibility Guidelines

---

This product was tested and complies with the regulatory requirements and limits for electromagnetic compatibility (EMC) as stated in the product specifications. These requirements and limits are designed to provide reasonable protection against harmful interference when the product is operated in its intended operational electromagnetic environment.

This product is intended for use in industrial locations. As such, there is no guarantee that harmful interference will not occur in a particular installation, when the product is connected to a test object, or if the product is used in residential areas. To minimize

the potential for the product to cause interference to radio and television reception or to experience unacceptable performance degradation, install and use this product in strict accordance with the instructions in the product documentation.

Furthermore, any changes or modifications to the product not expressly approved by National Instruments could void your authority to operate it under your local regulatory rules.



**Caution** To ensure compliance with the applicable regulatory requirements, product installation requires either special considerations or user-installed, add-on devices. See the product installation instructions for further information.



**Caution** The inputs/outputs of this product can be damaged if subjected to Electrostatic Discharge (ESD). To prevent damage, industry-standard ESD prevention measures must be employed during installation, maintenance, and operation.

## Special Conditions for Marine Applications

Some modules are Lloyd's Register (LR) Type Approved for marine applications. To verify Lloyd's Register certification, go to [ni.com/certification](http://ni.com/certification) and search for the LR certificate, or look for the Lloyd's Register mark on the module.



**Caution** To meet radio frequency emission requirements for marine applications, use shielded cables and install the system in a metal enclosure. Suppression ferrites must be installed on power supply inputs near power entries to modules and controllers. Power supply and module cables must be separated on opposite sides of the enclosure and must enter and exit through opposing enclosure walls.

## NI 9505 Hardware Overview

---

The NI 9505 provides unique flexibility and customization. The NI 9505 works together with the LabVIEW FPGA Module to create a highly customizable motor drive or actuator amplifier. Figure 1 illustrates the functionality of the NI 9505 working in conjunction with the LabVIEW FPGA Module in a typical motion control application. Figures 2 and 3 show more detailed versions of the position, velocity, and current loops implemented in the



LabVIEW FPGA Module. A typical application contains a position loop, velocity loop, and current loop, implemented in the LabVIEW FPGA Module block diagram. Depending on the application, you may not need to use all three loops. The examples installed in the `labview\examples\CompactRIO\Module Specific\NI 9505` directory illustrate methods for implementing each of these loops.

The NI 9505 returns the motor or actuator current data to the LabVIEW FPGA Module for use in a current loop or for monitoring. The NI 9505 also returns status information such as drive fault status, VSUP presence, and emergency stop status to the LabVIEW FPGA Module for use in system monitoring. Refer to the *NI 9505 Reference Help* book in the *LabVIEW Help*, available by selecting **Help»Search the LabVIEW Help**, for more information about the available status information.

The LabVIEW FPGA Module generates a PWM signal and sends the signal to the NI 9505. The PWM signal is proportional to the desired current or torque you want to provide to the motor or actuator. Increasing the PWM duty cycle results in increased current and thus increased torque.

Quadrature encoder signals pass through the NI 9505 and are processed in the LabVIEW FPGA Module for use in the position

and velocity loops. Refer to Figure 1 for a typical NI 9505 connection example, including encoder and E-Stop inputs.

For more advanced motion control applications, SoftMotion provides functions for trajectory generation, spline interpolation, position and velocity PID control, and encoder implementation using both the LabVIEW Real-Time Module and the LabVIEW FPGA Module. With SoftMotion you can create a custom motion controller without the need to develop the trajectory generator or spline engine yourself. Refer to the `labview\examples\CompactRIO\Module Specific\NI 9505` directory for example VIs using the NI 9505 and SoftMotion.

**Figure 1. NI 9505 Block Diagram**

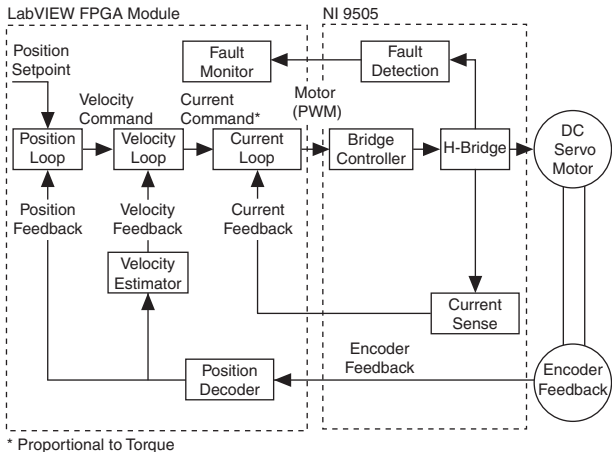

**Figure 2.** LabVIEW FPGA Module NI 9505 PID Loop

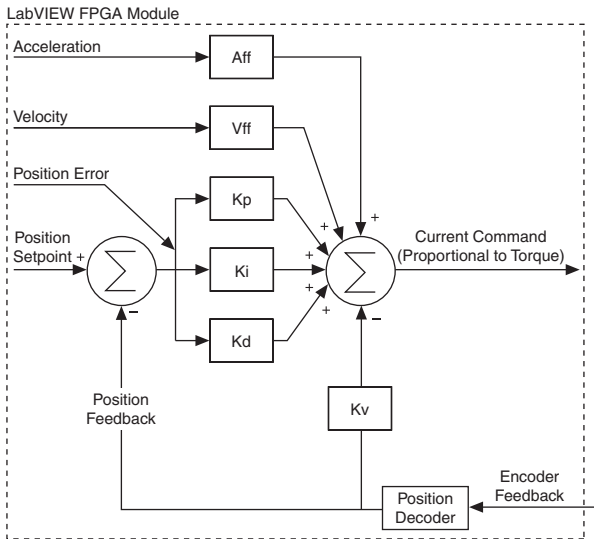

**Figure 3.** LabVIEW FPGA Module NI 9505 Current Loop

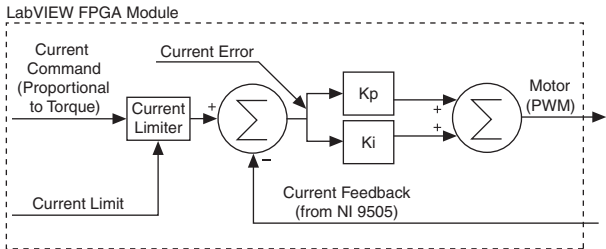

## Hot-Swap Behavior

The NI 9505 is always disabled when it is inserted in the chassis, regardless of whether VSUP is present or not. You can enable the drive using the **Enable Drive** method in software. Refer to the *NI 9505 Reference Help* book in the *LabVIEW Help*, available by selecting **Help»Search the LabVIEW Help**, for more information about enabling the drive.

When the NI 9505 is removed from the chassis while it is enabled, the power to the motor is removed and the motor decelerates to a stop based on its own friction.

## LED Indicators

The NI 9505 has four LEDs to display status information.

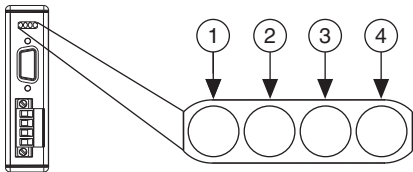

---

1 Power (green)	3 Disable (yellow)
2 VSUP (Motor Power) (green)	4 Fault (red)

---

### Power

The Power LED (green) illuminates when the NI 9505 is properly inserted into a powered chassis.



**Note** The Power LED does not illuminate when the chassis is in sleep mode.

### VSUP

The VSUP LED (green) illuminates when the motor DC power supply is properly connected and powering the drive.

## Disable

The Disable LED (yellow) illuminates when the drive is disabled. The drive is disabled by default at power-on. You can enable the drive using the **Enable Drive** method in software. Refer to the *NI 9505 Reference Help* book in the *LabVIEW Help*, available by selecting **Help»Search the LabVIEW Help**, for more information about this method.

## Fault



**Caution** If the Fault LED is lit, determine the cause of the fault and correct it before enabling the drive.

The Fault LED (red) illuminates when a fault occurs. A fault disables the drive. Causes for fault are the following:



**Caution** VSUP greater than 40 V will result in damage to the NI 9505.

- Overvoltage
- Undervoltage
- Motor terminal (MOTOR±) short to VSUP
- Motor terminal (MOTOR±) short to COM

- Module temperature exceeds 115 °C
- Sending commands to the motor before enabling the drive



**Note** Do not command motor movement until the drive is enabled with the **Enable Drive** method. Attempting to control the motor before it is enabled will result in a fault.

- Violating PWM minimum pulse width requirements. Refer to the *Specifications* section for more information about PWM.

## Sleep Mode

This module supports a low-power sleep mode. Support for sleep mode at the system level depends on the chassis that the module is plugged into. Refer to the chassis manual for information about support for sleep mode. If the chassis supports sleep mode, refer to the software help for information about enabling sleep mode. Visit [ni.com/info](http://ni.com/info) and enter `cseriesdoc` for information about C Series documentation.

Typically, when a system is in sleep mode, you cannot communicate with the modules. In sleep mode, the system consumes minimal power and may dissipate less heat than it does in normal mode. Refer to the *Specifications* section for more information about power consumption and thermal dissipation.





**Note** The Power LED does not illuminate when the chassis is in sleep mode.

## Wiring the NI 9505

---

The NI 9505 has a 9-pin female DSUB connector that provides connections for the encoder inputs, a +5 V connection for encoder power, a connection for an emergency stop input, and a connection to COM. Refer to Table 1 for the pin assignments.

The NI 9505 also has a screw terminal connector that provides connections to a motor DC power supply and a DC brushed servo motor. Connect the positive lead of the power supply to terminal 4, VSUP, and the negative lead to terminal 3, COM. Refer to Table 2 for the terminal assignments.



**Note** You must use 2-wire ferrules to create a secure connection when connecting more than one wire to a single terminal on the NI 9505 screw terminal.



**Caution** Do *not* turn on or plug in the motor DC power supply until the screw terminal connector is fully inserted.

**Table 1.** NI 9505 DSUB Pin Assignments

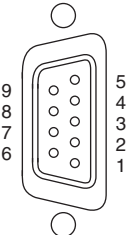
Connector	Pin	Signal
	1	Encoder Phase A+
	2	Encoder Phase B+
	3	Encoder Index+ (Phase Z+)
	4	Emergency Stop (E-Stop)
	5	+5 V (output)
	6	Encoder Phase A-
	7	Encoder Phase B-
	8	Encoder Index- (Phase Z-)
	9	Common (COM)

**Table 2.** NI 9505 Screw Terminal Terminal Assignments

Module	Terminal	Signal
	M+	MOTOR+
	M-	MOTOR-
	C	COM (motor DC power supply reference)
	V	VSUP (motor DC power supply)

Figure 4 shows a typical NI 9505 connection example, including encoder and E-Stop inputs.

**Figure 4.** NI 9505 Connections

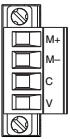
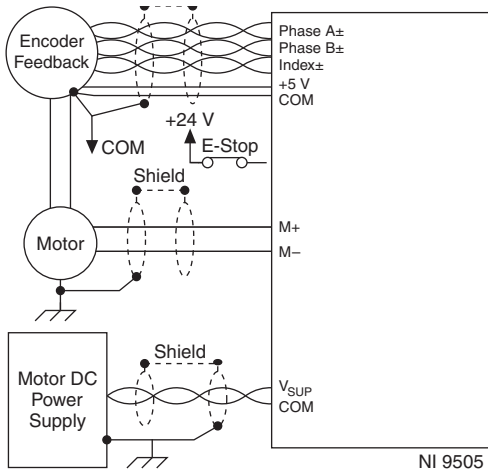

## Optional Screw Terminal Accessory

Use the NI 9931 Screw Terminal Accessory instead of the detachable screw terminal connector to increase the output power of the module at temperatures below 70 °C. The NI 9931 is available from [ni.com](http://ni.com) (NI part number 780571-01) or by calling your National Instruments sales representative. Refer to the [Specifications](#) section for more information. Refer to Figure 5 for an illustration.

**Figure 5.** NI 9505 Module with Optional Screw Terminal Accessory

---

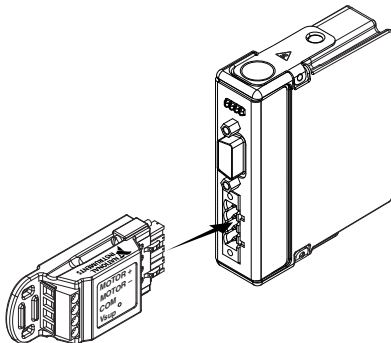

## Wiring for High Vibration Applications

National Instruments recommends using ferrules to terminate wires to the detachable screw terminal connector or the NI 9931 Screw Terminal Accessory when you use the NI 9505 in high vibration applications. Refer to Figure 6 for an illustration.

**Figure 6.** 4-Terminal Screw Terminal Connector or Accessory with a Ferrule

---

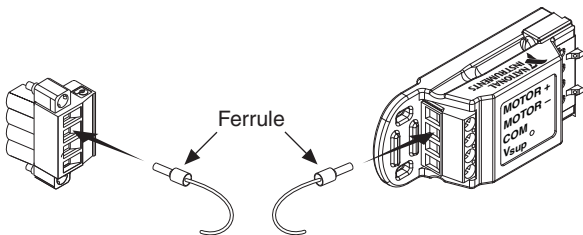

## Motor Power Signals

The MOTOR+ and MOTOR- signals power the servo motor. Motor direction is as follows:

- **Forward**—Clockwise (CW) facing motor shaft
- **Reverse**—Counterclockwise (CCW) facing motor shaft

Figure 7 shows clockwise and counterclockwise motor rotation.

**Figure 7.** Clockwise and Counterclockwise Motor Rotation

---

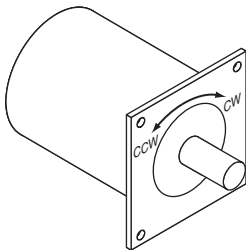

**Tip** If the motor does not turn in the desired direction, reverse the MOTOR+ and MOTOR- signals.

## Encoder Signals

The encoder signals consist of a Phase A, Phase B, and Index (Phase Z) input. The NI 9505 supports differential and single-ended inputs for Phase A, Phase B, and Index (Phase Z) signals. Figures 8 and 9 show simplified schematic diagrams of the encoder input circuit connected to differential and single-ended inputs. You can also accommodate open-collector output encoders

by using a 1 k $\Omega$  pull-up resistor on each line to +5 VDC. Refer to the *Specifications* section for more information about the encoder inputs.

The encoder signals are raw digital input signals. These signals are used in the LabVIEW FPGA Module for position and/or velocity feedback. Figures 8 and 9 illustrate the use of the encoder signals in a position and velocity loop in the LabVIEW FPGA Module. Refer to the examples installed at `labview\examples\CompactRIO\Module Specific\NI 9505` for examples of using the encoder signals. Refer to the *NI 9505 Reference Help* book in the *LabVIEW Help*, available by selecting **Help»Search the LabVIEW Help**, for more information.

If the encoder cable length is greater than 3.05 m (10 ft), use encoders with differential line driver outputs for your applications. Power for a +5 V encoder—generated by a power supply inside the NI 9505—is available on pin 5 of the DSUB connector.



**Note** The internal power supply is powered through the  $V_{sup}$  pin.

**Figure 8.** Differential Encoder Input Circuit

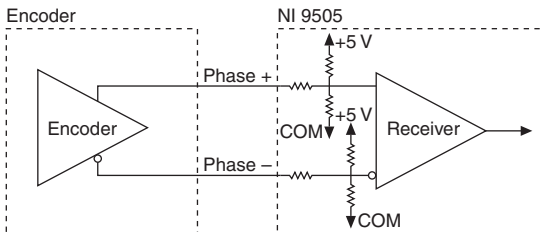

**Figure 9.** Single-Ended Encoder Input Circuit

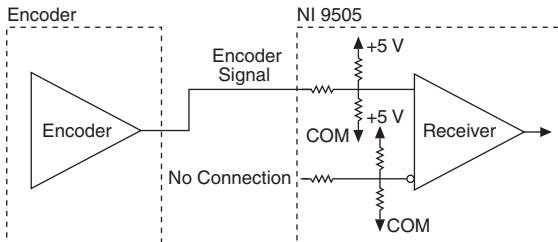



Closed-loop servo applications require consistent directional polarity between the motor and encoder for correct operation. One industry-standard directional polarity is as follows:

- Positive = forward = clockwise (CW) facing motor shaft
- Negative = reverse = counterclockwise (CCW) facing motor shaft

Refer to Figure 7 for a depiction of clockwise and counterclockwise rotation. If encoder counting does not behave as expected, change the encoder polarity in the FPGA or swap the Phase A and Phase B connections.

When connecting the encoder wiring to the NI 9505, use shielded wire of at least 24 AWG. You must use cables with twisted pairs and an overall shield for improved noise immunity. Refer to Figure 4 for a connection example.



**Note** Using an unshielded cable may produce noise, which can corrupt the encoder signals and cause lost counts, reduced accuracy, or other erroneous encoder and drive operation.

## Emergency Stop Signal

The E-Stop signal is an input to the drive from an emergency stop switch. Figure 10 shows a simplified schematic of the emergency stop input circuit. When the emergency stop switch is closed, current flows through the circuit, and the drive is enabled. When an external event activates the emergency stop switch, the switch opens and current stops flowing, disabling the drive. The E-Stop functionality is disabled by default. Refer to the *NI 9505 Reference Help* book in the *LabVIEW Help*, available by selecting **Help» Search the LabVIEW Help**, for information about how to enable this signal using the **Enable E-Stop** Property.

**Figure 10.** Emergency Stop Input Circuit

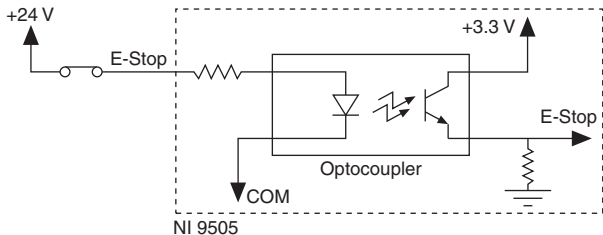

## Cable Requirements for EMC Compliance

---

Use the following guidelines when selecting cables for the NI 9505:

- Use shielded cables with a low impedance connection to chassis ground to minimize noise and signal crosstalk.
- Tie the VSUP cable shield to chassis ground at the module side only.
- Tie the motor cable shield to chassis ground at the motor side only.
- Tie the encoder cable shield to COM at the encoder side only.
- Wire encoder signals and their ground connections separately from all other connections to prevent lost encoder counts.
- Route wires along the machine frame to reduce high frequency noise.
- Add clamp-on ferrites to cables to further reduce emissions.
- Add a balun to the power cable to attenuate conducted and radiated emissions.

# Using the NI 9505 with Other C Series Modules

---

Due to additional ambient heating of the NI 9505 when supplying more than 1 A to the load, the room temperature (25 °C,  $\pm 5$  °C) specifications of adjacent modules are not valid. The full operating temperature (-40 °C to 70 °C) specifications for these modules are still valid.

## Specifications

---

The following specifications are typical for the temperature range -40 to 70 °C and a PWM rate of 20 kHz unless otherwise noted. All voltages are relative to COM unless otherwise noted.

## Operating Conditions

Motor DC power supply (VSUP) ..... +8 to +30 VDC, 12 A max

Motor continuous current<sup>1</sup>

(Motor $\pm$ ) ..... 1 A @ 70 °C  
5 A @ 40 °C

---

<sup>1</sup> For more information about maximum continuous current at temperatures less than 70 °C, visit [ni.com/info](http://ni.com/info) and enter `rdmot2`.

With NI 9931

screw terminal accessory..... 1 A @ 70 °C  
7.3 A @ 40 °C

Peak current<sup>1</sup>..... 12 A < 2 s max

PWM

Rate..... 20 kHz recommended,  
40 kHz max



**Caution** Violating minimum pulse width will result in unpredictable performance.

Minimum pulse width  
(high or low)..... 2  $\mu$ s

Drive direction update rate ..... Nominally 20  $\mu$ s

Current loop

ADC resolution ..... 12 bits

Current range.....  $\pm 12.7$  A

Maximum update rate..... 20  $\mu$ s

Minimum inductance ..... 500  $\mu$ H

---

<sup>1</sup> Allow at least 3.4 s between peak current intervals.

MTBF ..... 821,178 hours at 25 °C;  
Bellcore Issue 2, Method 1,  
Case 3, Limited Part Stress  
Method



**Note** Contact NI for Bellcore MTBF specifications at other temperatures or for MIL-HDBK-217F specifications.

## Drive Protection

Undervoltage..... <6 V



**Caution** VSUP greater than 40 V will result in damage to the module.

Overvoltage..... >32 V

Reverse polarity ..... -30 V

Motor terminal (MOTOR±)

short to ground..... Yes

Motor terminal (MOTOR±)

short to VSUP ..... Yes

Temperature fault trip point ..... 115 °C (internal module temperature)

## Encoder Input Characteristics

Number of inputs .....	3
Input type .....	Differential or single-ended
Voltage range .....	0 to 5.5 VDC
Digital logic levels	
Single-ended .....	TTL compatible
Input high threshold .....	2.4 V
Input low threshold .....	0.8 V
Differential	
Input threshold .....	$\pm 700$ mV, line driver compatible
Common-mode voltage .....	-7 to 12 V
Input current .....	$\pm 1$ mA
Maximum quadrature frequency .....	5 MHz

## E-Stop Input

Input voltage range .....	0 to 30 V
Input ON voltage .....	3.5 to 30 V
Input OFF voltage .....	0 to 2 V

Turn-on current ..... 500  $\mu$ A, typical  
1 mA, maximum

## Power Requirements

Power consumption from chassis

Active mode ..... 100 mW max

Sleep mode ..... 0.4 mW max

Thermal dissipation (at 70 °C)

Active mode ..... 1.5 W max

Sleep mode ..... 0.4 mW max

## Encoder Power Supply

5 V regulated output

Voltage tolerance ..... 5 V  $\pm$ 5%, VSUP  $\geq$  8 V

Current..... 125 mA

## Physical Characteristics

If you need to clean the module, wipe it with a dry towel.



**Note** For two-dimensional drawings and three-dimensional models of the C Series module and connectors, visit [ni.com/dimensions](http://ni.com/dimensions) and search by module number.



## Screw terminal wiring

Gauge .....	0.2 mm <sup>2</sup> to 2.5 mm <sup>2</sup> (26 to 14 AWG copper) conductor wire with 10 mm (0.39 in.) of insulation stripped from the end
Temperature rating .....	90 °C
Torque for screw terminals.....	0.5 to 0.6 N · m (4.4 to 5.3 lb · in.)
Wires per screw terminal.....	One wire per screw terminal, two when using 2-wire ferrule
Ferrules.....	0.25 mm <sup>2</sup> to 2.5 mm <sup>2</sup>

## Connector securement

Securement type .....	Screw flanges provided
Torque for screw flanges .....	0.2N · m (1.80 lb · in.)

Weight..... 155 g (5.5 oz)

## Safety

### Safety Voltages

Connect only voltages that are within the following limits.

Channel-to-COM ..... 0 to +30 VDC max,  
Measurement Category I

### Isolation

Channel-to-channel ..... None

Channel-to-earth ground

Continuous ..... 60 VDC,  
Measurement Category I

Withstand ..... 750 Vrms, verified by a 5 s  
dielectric withstand test

Measurement Category I is for measurements performed on circuits not directly connected to the electrical distribution system referred to as *MAINS* voltage. *MAINS* is a hazardous live electrical supply system that powers equipment. This category is for measurements of voltages from specially protected secondary circuits. Such voltage measurements include signal levels, special equipment, limited-energy parts of equipment, circuits powered by regulated low-voltage sources, and electronics.



**Caution** Do *not* connect the NI 9505 to signals or use for measurements within Measurement Categories II, III, or IV.

## Hazardous Locations

U.S. (UL) .....	Class I, Division 2, Groups A, B, C, D, T4; Class I, Zone 2, AEx nA IIC T4
Canada (C-UL) .....	Class I, Division 2, Groups A, B, C, D, T4; Class I, Zone 2, Ex nA IIC T4
Europe (DEMKO) .....	Ex nA IIC T4

## Safety and Hazardous Location Standards

This product is designed to meet the requirements of the following standards of safety for electrical equipment for measurement, control, and laboratory use:

- IEC 61010-1, EN 61010-1
- UL 61010-1, CSA 61010-1
- EN 60079-0:2012, EN 60079-15:2010
- IEC 60079-0: Ed 6, IEC 60079-15; Ed 4
- UL 60079-0; Ed 5, UL 60079-15; Ed 3

- CSA 60079-0:2011, CSA 60079-15:2012



**Note** For UL and other safety certifications, refer to the product label or the *Online Product Certification* section.

## Electromagnetic Compatibility

This product meets the requirements of the following EMC standards for electrical equipment for measurement, control, and laboratory use:

- EN 61326 (IEC 61326): Class A emissions; Industrial immunity
- EN 61800-3 (IEC 61800-3): Category C2 emissions; Second environment immunity
- EN 55011 (CISPR 11): Group 1, Class A emissions
- AS/NZS CISPR 11: Group 1, Class A emissions
- FCC 47 CFR Part 15B: Class A emissions
- ICES-001: Class A emissions



**Note** For the standards applied to assess the EMC of this product, refer to the *Online Product Certification* section.



**Note** For EMC compliance, operate this device with shielded cabling.

## CE Compliance

This product meets the essential requirements of applicable European directives as follows:

- 2014/35/EU; Low-Voltage Directive (safety)
- 2014/30/EU; Electromagnetic Compatibility Directive (EMC)
- 94/9/EC; Potentially Explosive Atmospheres (ATEX)

## Online Product Certification

Refer to the product Declaration of Conformity (DoC) for additional regulatory compliance information. To obtain product certifications and the DoC for this product, visit [ni.com/certification](http://ni.com/certification), search by module number or product line, and click the appropriate link in the Certification column.

## Shock and Vibration

To meet these specifications, you must panel mount the system and affix ferrules to the end of the screw terminal wires.

### Operating vibration

Random (IEC 60068-2-64)..... 5  $g_{rms}$ , 10 to 500 Hz

Sinusoidal (IEC 60068-2-6) ..... 5 g, 10 to 500 Hz

Operating shock (IEC 60068-2-27) .. 30 g, 11 ms half sine,  
50 g, 3 ms half sine,  
18 shocks at 6 orientations

## Environmental

National Instruments C Series modules are intended for indoor use only, but may be used outdoors if installed in a suitable enclosure. Refer to the manual for the chassis you are using for more information about meeting these specifications.

Operating temperature

(IEC 60068-2-1, IEC 60068-2-2) ..... -40 to 70 °C

Storage temperature

(IEC 60068-2-1, IEC 60068-2-2) ..... -40 to 85 °C

Ingress protection..... IP 40

Operating humidity

(IEC 60068-2-56)..... 10 to 90% RH,  
noncondensing

Storage humidity

(IEC 60068-2-56)..... 5 to 95% RH, noncondensing

Maximum altitude..... 2,000 m

Pollution Degree (IEC 60664)..... 2

# Environmental Management

NI is committed to designing and manufacturing products in an environmentally responsible manner. NI recognizes that eliminating certain hazardous substances from our products is beneficial to the environment and to NI customers.

For additional environmental information, refer to the *Minimize Our Environmental Impact* web page at [ni.com/environment](http://ni.com/environment). This page contains the environmental regulations and directives with which NI complies, as well as other environmental information not included in this document.

## Waste Electrical and Electronic Equipment (WEEE)



**EU Customers** At the end of the product life cycle, all products *must* be sent to a WEEE recycling center. For more information about WEEE recycling centers, National Instruments WEEE initiatives, and compliance with WEEE Directive 2002/96/EC on Waste and Electronic Equipment, visit [ni.com/environment/weee](http://ni.com/environment/weee).

## 电子信息产品污染控制管理办法（中国 RoHS）



**中国客户** National Instruments 符合中国电子信息产品中限制使用某些有害物质指令 (RoHS)。关于 National Instruments 中国 RoHS 合规性信息，请登录 [ni.com/environment/rohs\\_china](http://ni.com/environment/rohs_china)。(For information about China RoHS compliance, go to [ni.com/environment/rohs\\_china](http://ni.com/environment/rohs_china).)

## Worldwide Support and Services

---

The NI website is your complete resource for technical support. At [ni.com/support](http://ni.com/support) you have access to everything from troubleshooting and application development self-help resources to email and phone assistance from NI Application Engineers.

Visit [ni.com/services](http://ni.com/services) for NI Factory Installation Services, repairs, extended warranty, and other services.

Visit [ni.com/register](http://ni.com/register) to register your NI product. Product registration facilitates technical support and ensures that you receive important information updates from NI.

A Declaration of Conformity (DoC) is our claim of compliance with the Council of the European Communities using the manufacturer's declaration of conformity. This system affords the



user protection for electromagnetic compatibility (EMC) and product safety. You can obtain the DoC for your product by visiting [ni.com/certification](http://ni.com/certification). If your product supports calibration, you can obtain the calibration certificate for your product at [ni.com/calibration](http://ni.com/calibration).

NI corporate headquarters is located at 11500 North Mopac Expressway, Austin, Texas, 78759-3504. NI also has offices located around the world. For telephone support in the United States, create your service request at [ni.com/support](http://ni.com/support) or dial 1 866 ASK MYNI (275 6964). For telephone support outside the United States, visit the Worldwide Offices section of [ni.com/niglobal](http://ni.com/niglobal) to access the branch office websites, which provide up-to-date contact information, support phone numbers, email addresses, and current events.

Refer to the *NI Trademarks and Logo Guidelines* at [ni.com/trademarks](http://ni.com/trademarks) for more information on National Instruments trademarks. Other product and company names mentioned herein are trademarks or trade names of their respective companies. For patents covering National Instruments products/technology, refer to the appropriate location: **Help»Patents** in your software, the `patents.txt` file on your media, or the *National Instruments Patent Notice* at [ni.com/patents](http://ni.com/patents). You can find information about end-user license agreements (EULAs) and third-party legal notices in the readme file for your NI product. Refer to the *Export Compliance Information* at [ni.com/legal/export-compliance](http://ni.com/legal/export-compliance) for the National Instruments global trade compliance policy and how to obtain relevant HTS codes, ECCNs, and other import/export data. NI MAKES NO EXPRESS OR IMPLIED WARRANTIES AS TO THE ACCURACY OF THE INFORMATION CONTAINED HEREIN AND SHALL NOT BE LIABLE FOR ANY ERRORS. U.S. Government Customers: The data contained in this manual was developed at private expense and is subject to the applicable limited rights and restricted data rights as set forth in FAR 52.227-14, DFAR 252.227-7014, and DFAR 252.227-7015.

© 2010–2015 National Instruments. All rights reserved.