

COMPREHENSIVE SERVICES

We offer competitive repair and calibration services, as well as easily accessible documentation and free downloadable resources.

SELL YOUR SURPLUS

We buy new, used, decommissioned, and surplus parts from every NI series. We work out the best solution to suit your individual needs.

 Sell For Cash  Get Credit  Receive a Trade-In Deal

OBSOLETE NI HARDWARE IN STOCK & READY TO SHIP

We stock **New**, **New Surplus**, **Refurbished**, and **Reconditioned** NI Hardware.



Bridging the gap between the manufacturer and your legacy test system.

 1-800-915-6216

 www.apexwaves.com

 sales@apexwaves.com

All trademarks, brands, and brand names are the property of their respective owners.

Request a Quote

 **CLICK HERE**

NI-9754

GETTING STARTED GUIDE

NI Powertrain Control Modules

This document provides installation and safety information for National Instruments Powertrain Control modules.

Refer to the documentation for your specific NI Powertrain Control module to determine the safety ratings and specifications. Visit ni.com/info and enter Info Code NIPCP for more information about the family of NI Powertrain Control modules.



Required Components

The following items are necessary to set up and use your NI Powertrain Control module:

- NI LabVIEW 2010 or later
 - NI LabVIEW Real-Time Module 2010 or later
 - NI LabVIEW FPGA Module 2010 or later
- NI RIO 3.5.1 or later
- The following National Instruments software packages:
 - NI Powertrain Controls Device Drivers 1.0 or later
 - VI Package Manager
 - LabVIEW FPGA Module Xilinx Tools 10.1 or later



Note The required version of LabVIEW FPGA Module Xilinx Tools corresponds to the version of LabVIEW you are using. Visit ni.com/info and enter the Info Code `rdsoftwareversion` to determine the correct version of LabVIEW FPGA Module Xilinx Tools to use with your system.

Installing Software

Visit ni.com/downloads and search `Powertrain Controls` to download and install the latest version of NI Powertrain Controls Device Drivers package for your module.

The NI Powertrain Controls Device Drivers package requires the VI Package Manager for installation. Refer to the instructions within the NI Powertrain Controls Device Drivers package for information about installing and running the device drivers package.

Installing the Hardware

Remove your module from the packaging and inspect it for damage.



Caution Do not install a damaged module into a chassis. Return the damaged module to National Instruments for repair. Visit ni.com/support for more information.

Refer to your module documentation for information about installing, powering, and using your module.

Platform Compatibility

NI Powertrain Control modules require a hardware support system to function. You cannot use the modules independently or interfaced with third-party devices at the backplane HD15 connector. NI Powertrain Control modules are compatible with the following National Instruments platforms:

- CompactRIO, which consists of a CompactRIO controller, chassis, or integrated controller/chassis.
- NI PXI, which consists of any NI PXI chassis, NI PXI RT controller, and NI PXI-78xxR R Series FPGA card. The NI Powertrain Control modules insert into an NI R Series expansion chassis. Connect an NI R Series expansion chassis to the NI PXI FPGA card using a SHC68-68-RDIO cable.



Note NI Powertrain Control modules are not compatible with the National Instruments CompactDAQ chassis.

You can use NI Powertrain Control modules with NI cRIO-911x, NI cRIO-907x, and NI R Series Expansion systems under the following conditions:

- Leave one empty chassis slot between NI Powertrain Control modules and other NI modules.
- Maintain an ambient system operating temperature of 0 °C to 45 °C.



Note Typical specifications of National Instruments modules might not apply when used in a system with NI Powertrain Control modules.



Note National Instruments guarantees warranted specifications for all National Instruments modules except thermocouple modules when used in a system with NI Powertrain Control modules.



Note National Instruments recommends the NI 9214 for thermocouple measurements in CompactRIO systems using NI Powertrain Control modules.



Note NI Powertrain Control modules do not support Scan Interface mode, auto-detection, or ID mode.

Safety

Read the following safety information before operating your module.

Reverse Battery Polarity



Caution NI Powertrain Control modules are not internally protected against reverse battery polarity. Do not reverse the battery polarity. Damage resulting from reverse battery polarity is not covered by warranty.



Caution The fuse illustrated in Figure 1 is user-supplied and required in all instances.

All NI Powertrain Control modules with a 10-pin screw terminal blocks have identical external power and ground connections. Ensure that Batt (0) and GND (9) are not connected in reverse polarity. The Batt (0) terminal can accept positive 6 VDC to 32 VDC with respect to the GND (9) terminal. Refer to the following figure for information about implementing a simple external main-power-relay circuit.

National Instruments recommends the following steps when implanting a simple external main-power-relay circuit:

- Use an automotive relay which includes an internal series diode to prevent reverse battery polarity from energizing the relay.
- Connect screw terminals 87 and 30 with soldered ring terminals. Terminals 86 and 85 are 6.3 mm × 0.8 mm (0.250 in. × 0.031 in.) push-on terminals.
- Use a fuse between the battery and the relay.
- You can also use a switch in series with relay terminal 86.



Note Placing a high-current-capacity diode in series with the system power is not an acceptable method of reverse battery protection because it does not allow the modules to perform current recirculation while switching inductive loads.



Note If the automotive relay is unavailable, you can create a similar circuit with a simple power relay and a diode in series with the solenoid.

National Instruments recommends using the Reverse Battery Protection Relay, part number 782784-01.

Figure 1. Simple External Main-Power-Relay Circuit

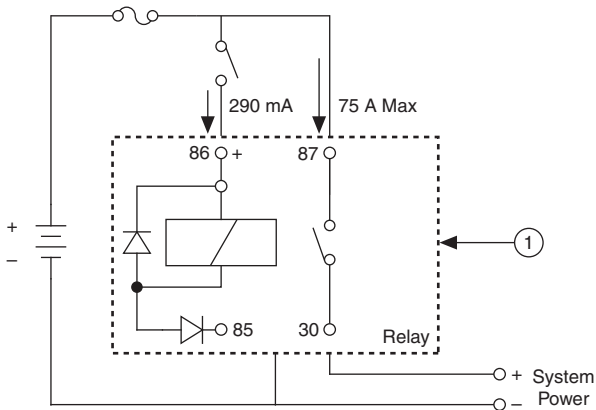

1 Relay



Caution The fuse illustrated in Figure 1 is user-supplied and required in all instances.

Safety Guidelines

Refer to your module-specific documentation for specific safety and operating instructions.



Caution Do not operate your module in a manner not specified in the operating instructions. Module misuse can result in a hazard. You can compromise the safety protection built into the module if the module is damaged in any way. If the module is damaged, return it to National Instruments for repair.

Where to Go Next

Refer to the documentation for your NI Powertrain Control module to determine the safety ratings and specifications, as well as information about installing, configuring, and programming your module. Visit ni.com/info and enter the following Info Codes for module-specific documentation:

- **NIPCP**—Information about the family of NI Powertrain Control modules.
- **DIDRIVER**—Information about the NI 9751 Direct Injector Driver Module and accessories.

- **ADCOMBO**—Information about the NI 9752 Automotive AD Combo Module and accessories.
- **DIFFIO**—Information about the NI 9753 Differential Digital I/O Module and accessories.
- **ESTTL**—Information about the NI 9754 Engine-Synchronous TTL Output Module and accessories.
- **NOXCRIO**—Information about the NI 9755 CompactRIO NOx Sensor Module Kit and accessories.
- **NOXUSB**—Information about the NI 9756 USB NOx Sensor Module Kit and accessories.
- **O2MODULE**—Information about the NI 9757 O2 Sensor Module Kit and accessories.
- **PFI**—Information about the NI 9758 Port Fuel Injector Module and accessories.
- **THROTTLE**—Information about the NI 9759 Electronic Throttle Driver Module and accessories.
- **VRHALL**—Information about the NI 9760 VR/Hall Module and accessories.

Enter `Powertrain Control` in the LabVIEW NI Example Finder to locate example VIs for your module.

Worldwide Support and Services

The National Instruments website is your complete resource for technical support. At ni.com/support you have access to everything from troubleshooting and application development self-help resources to email and phone assistance from NI Application Engineers.

Visit ni.com/services for NI Factory Installation Services, repairs, extended warranty, and other services.

Visit ni.com/register to register your National Instruments product. Product registration facilitates technical support and ensures that you receive important information updates from NI.

National Instruments corporate headquarters is located at 11500 North Mopac Expressway, Austin, Texas, 78759-3504. National Instruments also has offices located around the world. For telephone support in the United States, create your service request at ni.com/support or dial 512 795 8248. For telephone support outside the United States, visit the Worldwide Offices section of ni.com/niglobal to access the branch office websites, which provide up-to-date contact information, support phone numbers, email addresses, and current events.

Refer to the *NI Trademarks and Logo Guidelines* at ni.com/trademarks for more information on National Instruments trademarks. Other product and company names mentioned herein are trademarks or trade names of their respective companies. For patents covering National Instruments products/technology, refer to the appropriate location: **Help»Patents** in your software, the `patents.txt` file on your media, or the *National Instruments Patent Notice* at ni.com/patents. You can find information about end-user license agreements (EULAs) and third-party legal notices in the readme file for your NI product. Refer to the *Export Compliance Information* at ni.com/legal/export-compliance for the National Instruments global trade compliance policy and how to obtain relevant HTS codes, ECCNs, and other import/export data.

© 2013 National Instruments. All rights reserved.

376140A-01

Sep13