

COMPREHENSIVE SERVICES

We offer competitive repair and calibration services, as well as easily accessible documentation and free downloadable resources.

SELL YOUR SURPLUS

We buy new, used, decommissioned, and surplus parts from every NI series. We work out the best solution to suit your individual needs.

 Sell For Cash  Get Credit  Receive a Trade-In Deal

OBSOLETE NI HARDWARE IN STOCK & READY TO SHIP

We stock **New**, **New Surplus**, **Refurbished**, and **Reconditioned** NI Hardware.



Bridging the gap between the manufacturer and your legacy test system.

 1-800-915-6216

 www.apexwaves.com

 sales@apexwaves.com

All trademarks, brands, and brand names are the property of their respective owners.

Request a Quote

 **CLICK HERE**

NI-9760



**National Instruments Expandable
Direct Injector Driver System
NI EDIDS-2400 Series User Manual
NI EDIDS-2403
NI EDIDS-2406
NI EDIDS-2409
NI EDIDS-2412**

NI Expandable Direct Injector Driver System User guide
February 2016

Table of Contents

1. About the NI Expandable Direct Injector Driver System.....	6
2. Warnings.....	7
2.1 REVERSE BATTERY POLARITY WARNING.....	8
2.2 HIGH VOLTAGE WARNING	9
3. Getting Started	10
3.1 What Is Included	11
3.2 Software.....	13
3.2.1 SCM Software Installation.....	14
3.2.2 NI-XNET Driver Installation	18
3.2.3 Connecting To The DI Driver System	19
3.2.3.1 Out Of The Box Connection	20
3.2.3.2 Changing The Network Settings Of The DI Driver System.....	26
3.2.3.3 Manually Resetting The Controller Network Interface To DHCP	28
3.2.3.4 SCM and Windows Firewall.....	31
3.2.4 Updating DI Driver System Controller Software	36
3.2.5 Backing Up the DI Driver System Software Image.....	38
3.2.6 Restoring A Backup Image To The DI Driver System Controller	40
3.3 Hardware	43
3.3.1 C-Series Module Slot Assignments	44
3.3.2 Powering the System	46
3.3.3 Connecting Injectors, Sensors and Actuators.....	48
3.3.3.1 Direct Injectors to DI Driver Channels	49
3.3.3.2 Port Fuel Injectors to PFI Channels.....	51
3.3.3.3 Proportional Solenoid Valves to PFI Lowside Channels	53
3.3.3.4 Digital Signals to NI 9411 Digital Input Module.....	54
3.3.3.5 Analog Signals to NI 9220 Analog Input Module	57
3.3.4 DI Driver System Component User Manual Reference	58
3.3.5 Optional Enclosure System.....	59
3.4 Using DI Driver System to Control Fuel Pressure.....	62
3.5 Optimizing the DI Driver System	64
4. NI Direct Injector Driver System Interface	65
4.1 DI Driver Setup Window	67
4.1.1 DI Driver Scope Window.....	78
4.2 PFI and LS Driver Setup Window.....	79
4.2.1 PFI Module Control Tab	80
4.2.2 PFI 1-4 Tab	84
4.2.3 LS 1-4 Tab.....	87
4.3 ESTTL Spark Setup	91
4.3.1 ESTTL 1 TDC Channel Mapping Tab.....	92
4.3.2 ChX Tabs.....	96
4.4 General Purpose ESTTL Setup Window	99
4.4.1 ESTTL 2 TDC Channel Mapping Tab.....	100
4.4.2 ESTTL 2 Pulse Generation Setup Tab	103
4.5 Throttle Driver Setup Window	106
4.5.1 Channel X Control Tab.....	109
4.5.2 Channel X Position Calibration Tab	112

4.5.3 Channel X Control Calibration Tab	119
4.6 UEGO Setup Window	129
4.7 Digital Input Setup Window.....	136
4.8 Expansion Digital and VR/Hall Input Setup Window	140
4.8.1 VR/Hall Input Setup Window.....	144
4.9 Analog Input Setup Window	146
4.10 Pulse Generation Setup Window	149
4.10.1 DI-TMP Tab	150
4.10.2 DI-EPT Tab.....	154
4.10.2.1 DI Advanced Settings Window.....	159
4.10.3 PFI X Tabs	163
4.11 Engine Position Tracking Setup Window	167
4.11.1 EPT Tab.....	178
4.11.2 TDC Channel Mapping Tab.....	188
4.11.3 Cam Phase Capture Tab.....	192
4.11.4 EPT Diagnostics Tab.....	198
4.13 Calibration Mode Setup Window.....	201
4.14 Expansion Calibration Mode Setup Window.....	205
4.15 Direct Mapping	209
4.16 Table Setup Window	212
4.16.1 Table1D.....	213
4.16.2 Table2D.....	216
4.17 Auxiliary PID Controller Setup Window	219
4.18 Rail Pressure Control Setup Window	225
4.19 Auxiliary PWM Setup Window	239
4.20 Expansion Auxiliary PWM Setup Window	242
4.21 Operating Point Setup Window.....	245
4.22 User Variables	253
4.23 XNET CAN Setup Window	255
4.23.1 NI-XNET Database Editor.....	263
4.23.1.1 CAN Signal Dialog	265
4.23.1.2 Manage NI-XNET Databases Dialog	269
4.24 TDK HV Supply Control Setup Window.....	272
4.25 Active Flex Control Parameters Window	276
4.26 CalScopes Window	277
4.27 CalTrend Window.....	278
4.28 Log Data Setup Window	279
4.29 Faults Window.....	284
4.30 Execution Information Window.....	288
4.30.1 Static Info	289
4.30.2 Network.....	290
4.30.3 Run-Time Info.....	291
4.30.4 Expansion/Misc. Execution Info	292
5. Troubleshooting	293
6. Diagrams	295
7. Additional Support/Feedback	307
8. Important Information	308

8.1 Warranty	309
8.2 Copyright	310
8.3 Trademarks.....	311
8.4 Patents.....	312
8.5 Warning Regarding Use of NI Products	313
8.6 Environmental Management	314

1. About the NI Expandable Direct Injector Driver System

The NI Expandable Direct Injector Driver System features an NI cRIO-9082 controller, NI 9751 Direct Injector (DI) driver module(s), and NI 9411 digital input module(s). The system can synchronize injector channels with production crank/cam position sensors or optical encoders. The system will also accept external digital fuel command signals from a production engine controller. The included DI driver module(s) provide the power electronics necessary to drive high-power solenoid or piezoelectric direct injectors.

The NI Expandable Direct Injector Driver System comes in four different base models corresponding to different direct injector channel configurations: the NI EDIDS-2403 drives 3 solenoid injectors (or 2 piezoelectric injectors), the NI EDIDS-2406 drives 6 solenoid injectors (or 4 piezoelectric injectors), the NI EDIDS-2409 drives 9 solenoid injectors (or 6 piezoelectric injectors), and the NI EDIDS-2412 drives 12 solenoid injectors (or 8 piezoelectric injectors). The systems provide a digital input per injector channel for directly commanding each injector. The system controller is delivered with a pre-installed feature-rich application. The deployment version of the NI Software Calibration Manager Toolkit (SCM) is included for interfacing with and calibrating the system.

The NI Expandable Direct Injector Driver System supports optional C-series modules in slots 7 & 8 of the cRIO-9082. The optional NI 9220 analog input module (slot 7) can be used for a variety of analog sensors. The optional NI 9862 XNET CAN module (slot 8) can be used to send and receive parameter values within the system to/from other CAN communication devices. The cRIO-9082 controller may be expanded with a NI-9155 MXIe Expansion Chassis for additional optional modules with designated slots. Examples of optional modules designated to expansion slots are NI-9758 Port Fuel Injector Driver Module, NI-9754 Engine Synchronous TTL Output Module, NI-9757 Bosch LSU 4.2 and 4.9 O2 Sensor Module, NI-9759 Throttle Driver Module and the NI 9760 VR/Hall Sensor Module.

Throughout this manual, the module model numbers NI 9XXX (ex. NI 9751) and module model names (ex. DI Driver module) are used interchangeably. Also, the NI Expandable Direct Injector Driver System will be referred to as the NI Direct Injector Driver System.

2. Warnings

Please read the following warnings for your safety and that of the product.

2.1 REVERSE BATTERY POLARITY WARNING

NI Powertrain Controls power modules are not internally protected against reverse battery polarity. Do not reverse the battery polarity or damage will occur. This event is not covered under warranty.

All NI Powertrain Controls modules with a 10-pin screw terminal block have identical external power and ground connections. Please take necessary precautions to ensure that BATT (0) and GND (9) are not connected in reverse polarity. The BATT (0) terminal will accept positive 7-32VDC with respect to the GND (9) terminal. Please refer to the user manual for details.

To provide system-level protection against reverse battery polarity, implement the following simple external main-power-relay circuit:

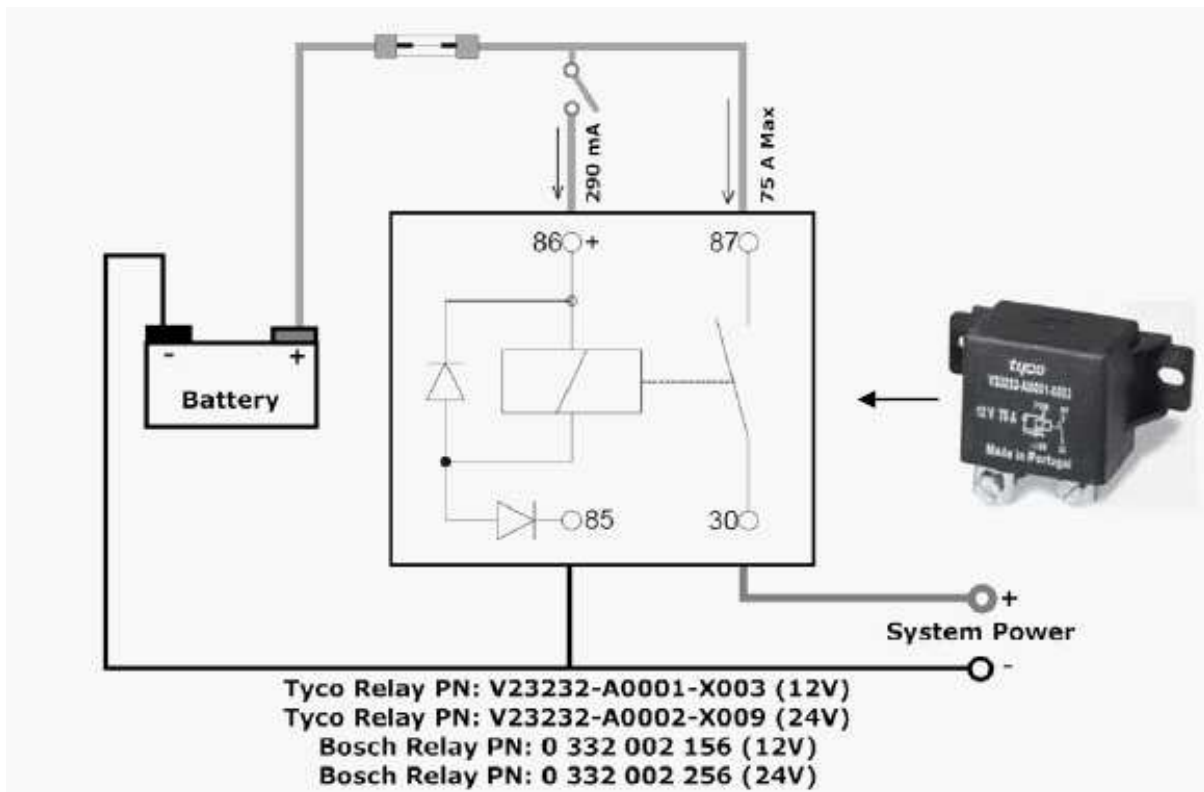

Figure 2.1.a, Reverse Battery Protection Diagram

Notes:

- 1.) The relay shown is a type of automotive relay which includes an internal series diode with terminal 85. This diode will prevent reverse battery from energizing the relay.
- 2.) Terminals 30 and 87 are screw terminals and should be connected with soldered ring terminals.
- 3.) Terminals 85 and 86 are 0.250 X 0.031 inch (6.3 X 0.8 mm) push-on terminals.
- 4.) A fuse is recommended between the battery and relay.
- 5.) An optional switch may be placed in series with relay terminal 86.
- 6.) Simply placing a high-current-capacity diode in series with the system power is not an acceptable method of reverse battery protection because it will not allow the NI Powertrain Controls modules to perform current recirculation while switching inductive loads.
- 7.) The relay is currently available from www.ni.com.

2.2 HIGH VOLTAGE WARNING



HIGH VOLTAGE: This device is capable of operating at voltages up to 190V. Extreme care should be taken to protect against shock. Even when the device is completely powered down, allow approximately five minutes for the internal high voltage to dissipate. Do not touch any of the driver module screw terminals or injector terminals while the device is powered.

3. Getting Started

This guide will provide instructions to set up the NI Direct Injector Driver System hardware and software.

3.1 What Is Included

Software

1. DI Driver System software image pre-installed on the system controller
2. NI Software Calibration Management Toolkit (SCM) for LabVIEW, downloaded from www.ni.com.

Hardware

1. Expandable Direct Injector Driver System



DI Driver System	cRIO-9082 Integrated Controller & Chassis 781787-02	NI 9411 Digital Input Module 779005-01	NI 9751 DI Driver Module 782076-01
EDIDS-2403	1	1	1
EDIDS-2406	1	1	2
EDIDS-2409	1	2	3
EDIDS-2412	1	2	4

Table 3.1.a, I/O Hardware Included In The Expandable DI Driver System

Optional I/O modules supported by all DI Driver Systems

- [NI-9220](#) 16-Channel, 100 kS/s/ch, 16-bit, ±10 V Analog Input Module, 37-Pin D-SUB (P/N: 782615-01)
- [NI-9862](#) 1-Port High-Speed/FD NI-XNET CAN C Series Module (P/N: 781639-01)



Optional I/O modules supported by Optional NI-9155 MXIe Expansion Chassis

- [NI-9411](#) 6-Channel, 500 ns, ±5 to 24 V, Differential Digital Input Module (P/N: 779005-01)
- [NI-9754](#) 8 Channel TTL Output Module for Engine Synchronous Digital Output(P/N: 782077-01)
- [NI-9757](#) 2-Channel Bosch LSU 4.2 or 4.9 wideband sensor controller module (P/N: 782079-01)
- [NI-9758](#) PFI Driver Module (P/N: 782080-01)
- [NI-9759](#) Electronic Throttle Driver Module (P/N: 782081-01)

2. Piezo Injector Inductors (P/N: 782082-01)

Piezo Injector Inductor Packs Included In Each DI Driver System	
DI Driver System	Number of Inductors
EDIDS-2403	2 (1 pack)
EDIDS-2406	4 (2 packs)
EDIDS-2409	6 (3 packs)
EDIDS-2412	8 (4 packs)



Table 3.1.b, Number of Inductors Included With The DI Driver System

3. Reverse Battery Protection Relay (P/N: 782784-01)



4. NI 9411 Module Breakout Harness(es) per NI 9411 Module (P/N: 782785-01)

NI-9411 Breakout Harnesses Included In Each DI Driver System	
DI Driver System	Number of Harnesses
EDIDS-2403	1
EDIDS-2406	1
EDIDS-2409	2
EDIDS-2412	2



Table 3.1.c, Number of Harnesses Included With The DI Driver System

3.2 Software

3.2.1 SCM Software Installation

Software Download

At the time of shipping, the DI Driver System controller is pre-programmed with the latest version of software. However, in order to interact with the system, NI Software Calibration Management Toolkit (SCM) must be downloaded and installed to a PC with Windows 7 or newer. To download SCM follow the link below.

[Download SCM Software](#)

The link will take you to this webpage; click on download to begin the download process.

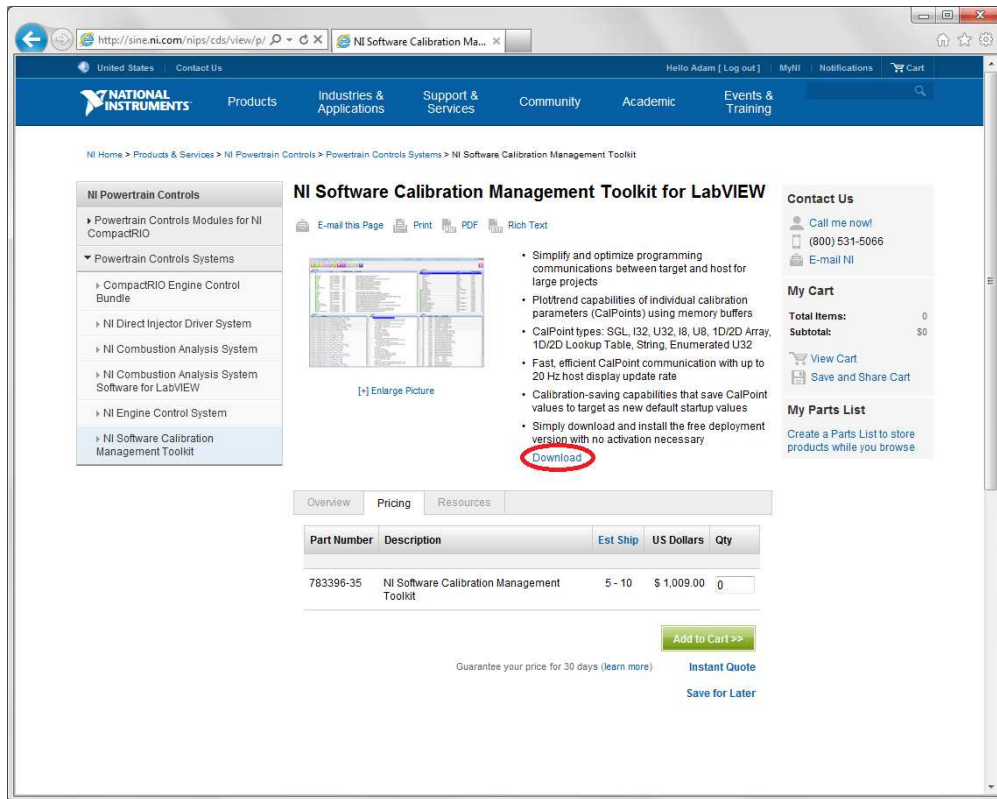

Enter your NI User Account information as directed. If you do not have an NI User Account, create one for free and then proceed.

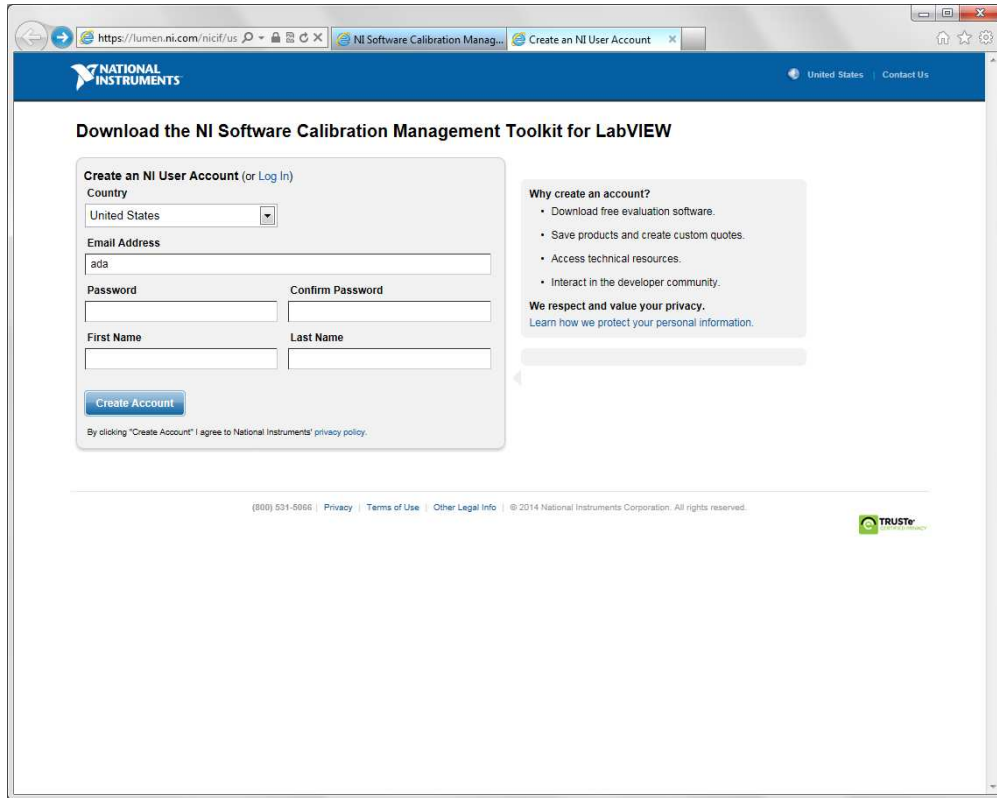

Download the most recent version of the software. When prompted, choose the option to save the file.

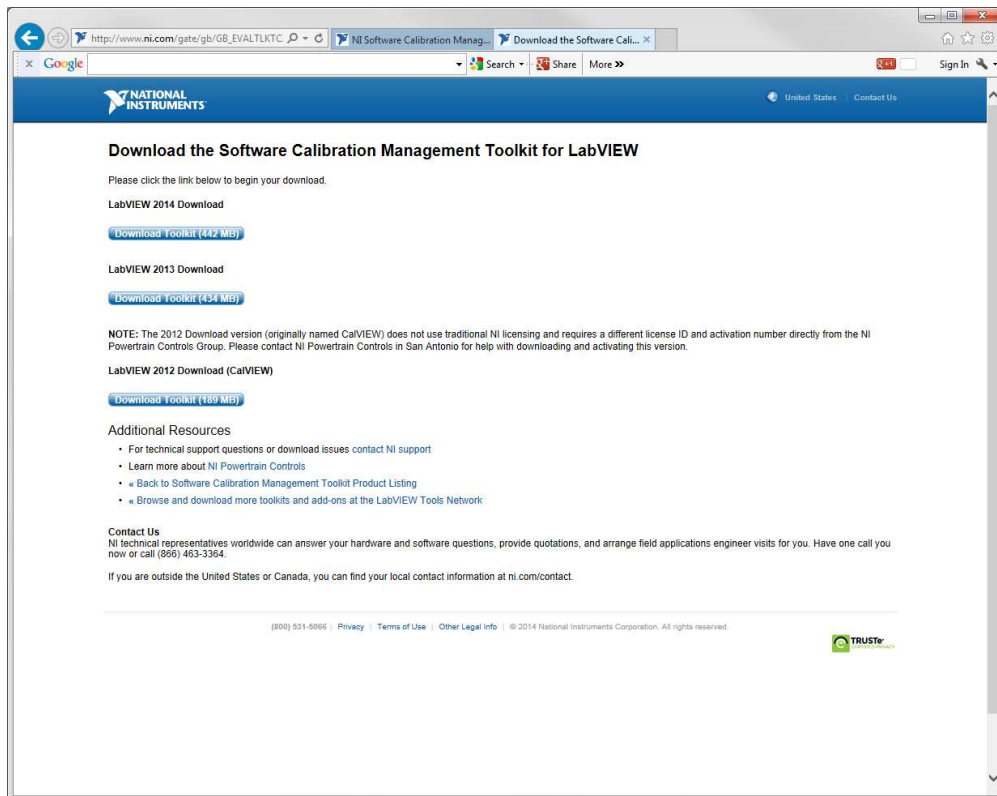

Software Installation

After the download is complete, browse to the location on disk where the file was saved. Extract the contents of the .zip file.

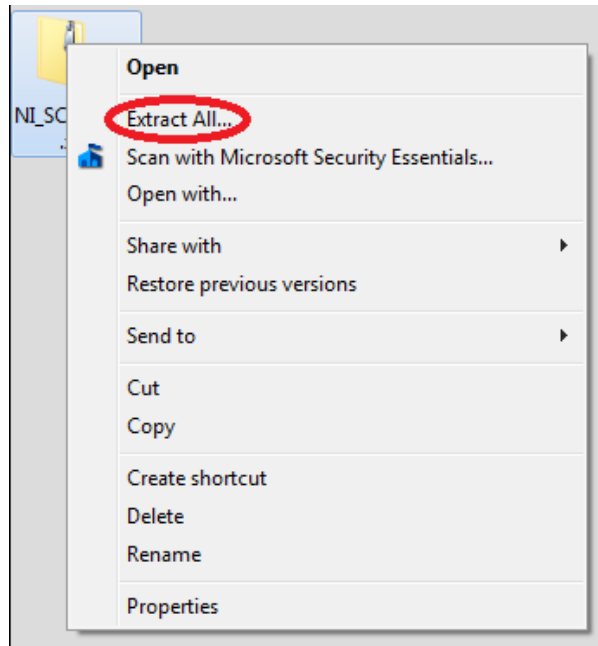

After extracting the file, open the created directory and run the Setup.exe application. If prompted, install Microsoft .NET Framework 4.0.

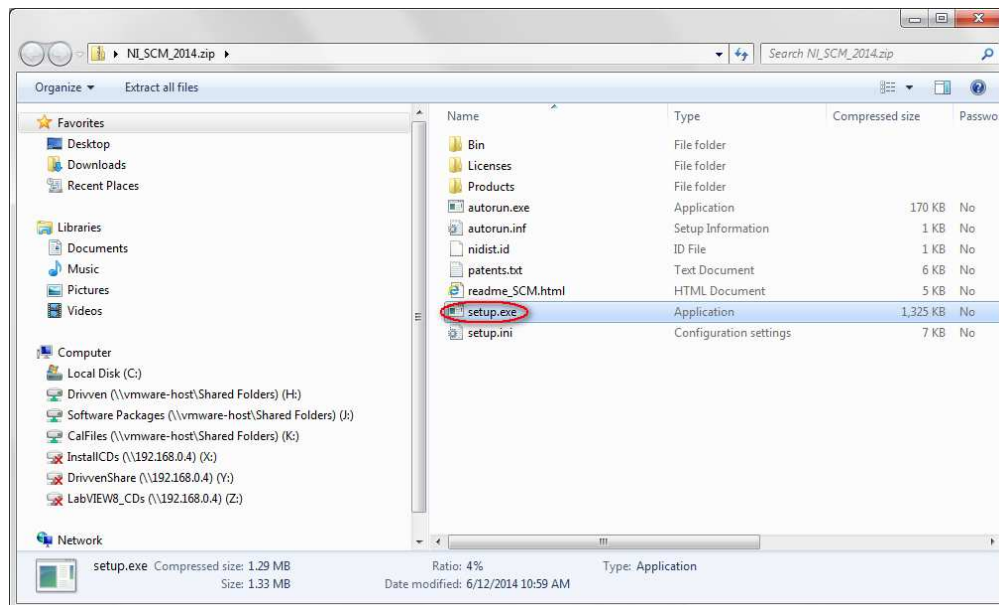

When prompted at the User Information screen, enter the relevant information and select the option to install the evaluation version of the license. The evaluation license is a free, perpetual license of SCM that allows users to interface to SCM-supported targets, but does not allow them to modify any code.



The image shows a Windows-style dialog box titled "Software Calibration Management Toolkit for LabVIEW 2014". The dialog has a header area with the text "User Information" and "Enter the following information." on the left, and the "NATIONAL INSTRUMENTS" logo on the right. Below the header, there are three text input fields: "Full Name:" with the text "Windows User", "Organization:", and "Serial Number:". There are two radio button options. The first option is "Install Software Calibration Management Toolkit for LabVIEW 2014 with this serial number." and the second option is "Install Software Calibration Management Toolkit for LabVIEW 2014 Evaluation - Serial number not required.", which is selected and circled in red. At the bottom of the dialog, there are three buttons: "<< Back", "Next >>", and "Cancel".

From there, follow the instructions and prompts to finish installing the software.

3.2.2 NI-XNET Driver Installation

If the user plans to utilize CAN communication on the NI EDIDS they must install NI-XNET Drivers. The drivers are free to download at <http://sine.ni.com/psp/app/doc/p/id/psp-903/lang/en>.

For installation instructions refer to [NI-XNET Hardware and Software Installation Guide](#). For additional information on NI-XNET refer to [NI-XNET Support](#).

3.2.3 Connecting To The DI Driver System

This section provides information about connecting to the DI Driver System user interface via SCM and how to change the network interface settings of the system controller.

3.2.3.1 Out Of The Box Connection

This section describes how to establish a connection with the DI Driver System user interface via SCM. NI ships the DI Driver System with an IP address of **192.168.1.100** and a Subnet mask of 255.255.255.0. The Windows PC used to interface with the system must have a similar IP address and Subnet mask, but the IP address must be different in the last address number. The directions below illustrate how to make the initial network connection to the system and open the system user interface.

1. The customer must provide a Windows 7 (or later) PC with an Ethernet LAN port.
2. Install [SCM for LabVIEW](#) to the PC.
3. Check the [Windows Firewall settings](#) or 3rd party firewall settings to allow SCM to communicate with the external system.
4. [Power up the DI Driver System controller](#). The DI Driver and PFI Driver modules do not need to be powered if simply attempting to establish a connection to the user interface. Wait about 1 minute for both the **USER1** and **USER FPGA1** LEDs to start blinking.
5. Using a CAT5E Ethernet cable, connect the Windows PC LAN port directly to the Ethernet port of the [cRIO-9082](#) controller . If the green and amber LEDs directly under the controller Ethernet port are not active, then there is no physical Ethernet connection to the PC. Please diagnose the Ethernet cable connection problem.
6. Go to the **Windows Control Panel** and select **Network and Sharing Center**. From the **Network and Sharing Center** select **Change adapter settings** from the left menu.

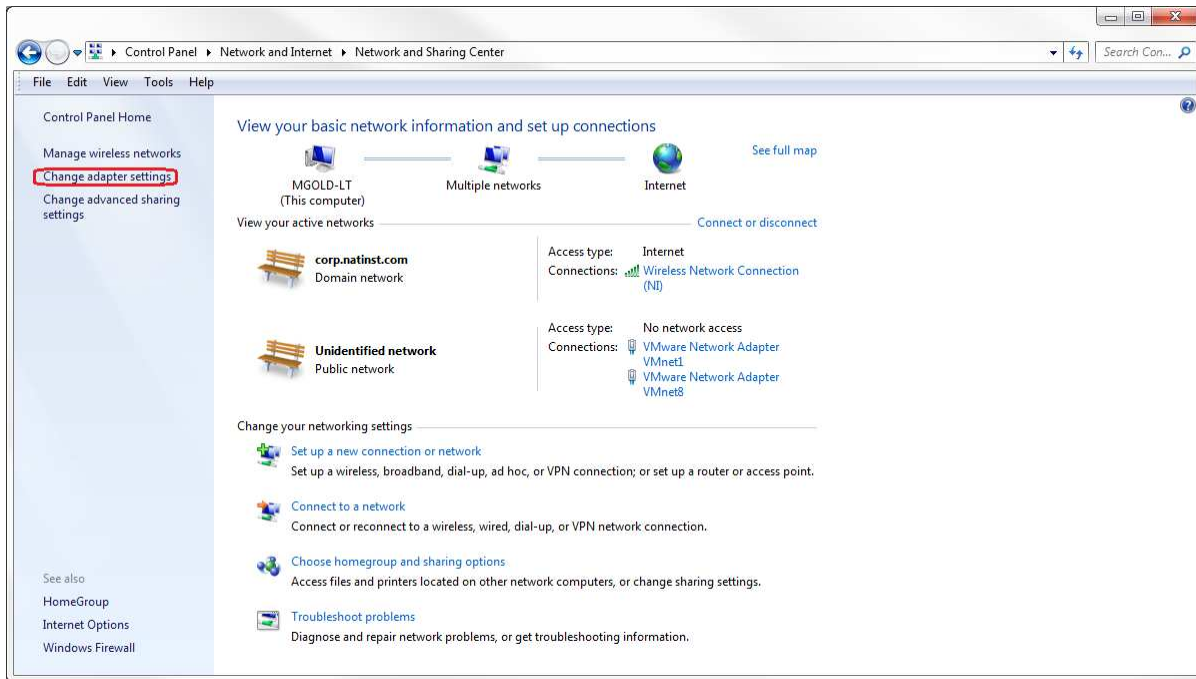

7. A list of network connections available on the PC will open. Right click the **Local Area Connection** port to select **Properties**.

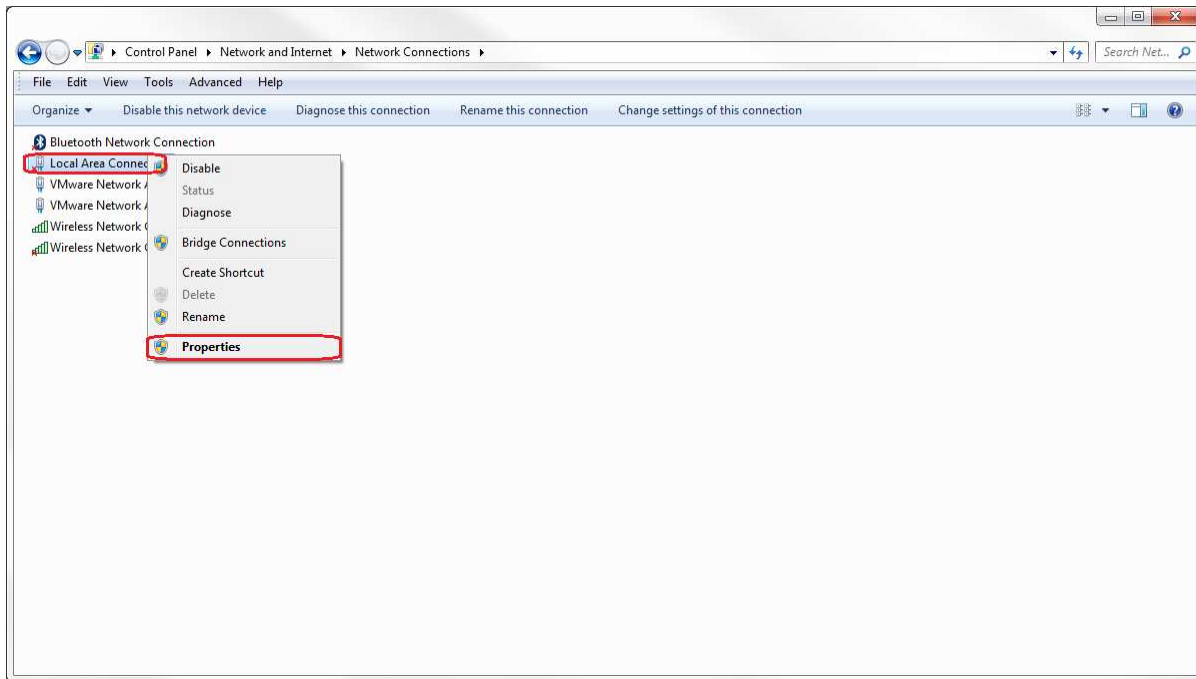

8. From the **Local Area Connection Properties** dialog, scroll down to select **Internet Protocol Version 4 (TCP/IPv4)** and select the **Properties** button below the scroll window.

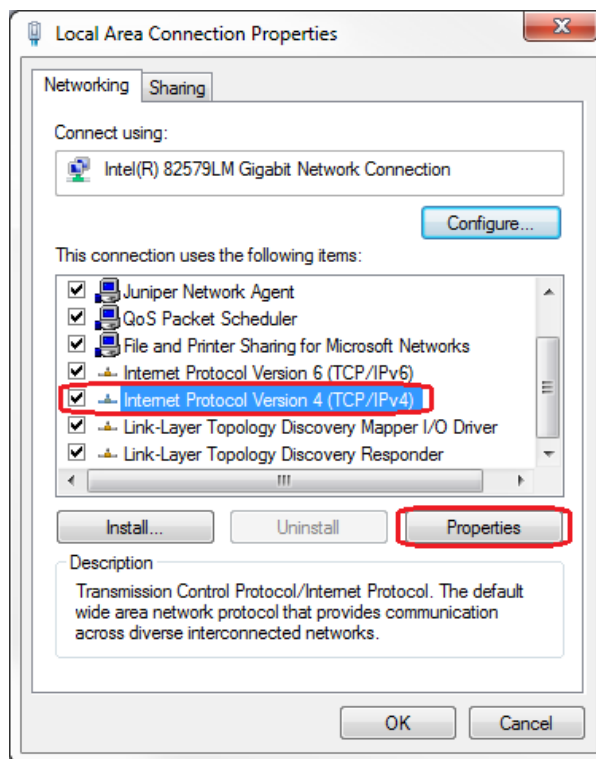

9. From the **Internet Protocol Version 4 (TCP/IPv4) Properties** dialog, select the **Use the following IP address** radio button. Enter **192.168.1.101** for the **IP address:** field. Enter **255.255.255.0** for the **Subnet mask:** field. Select **OK** on the **Internet Protocol Version 4 (TCP/IPv4) Properties** dialog and the **Local Area Connection Properties** dialog to accept the IP address changes.

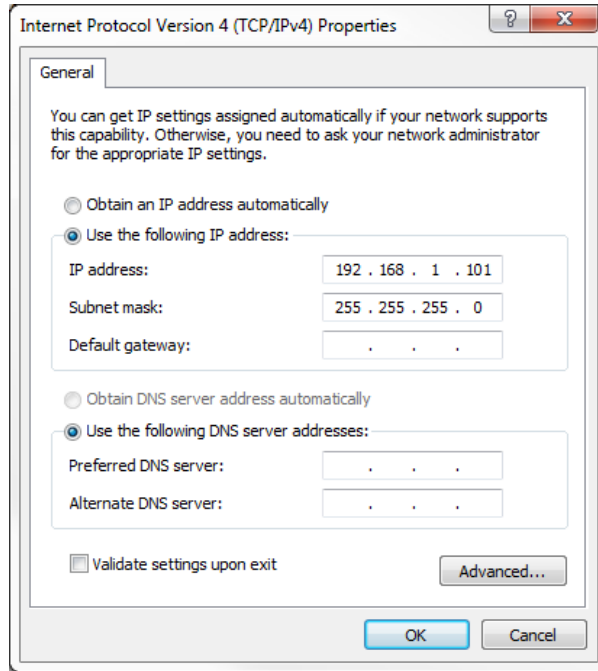

10. Open the NI SCM console from the **Windows Start menu** under **National Instruments >> Software Calibration Management**.

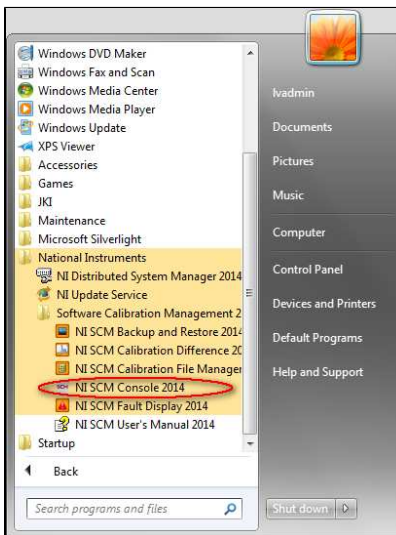

11. Within the SCM console, right-click inside the **Target Items** list pane and select **Select Target**.

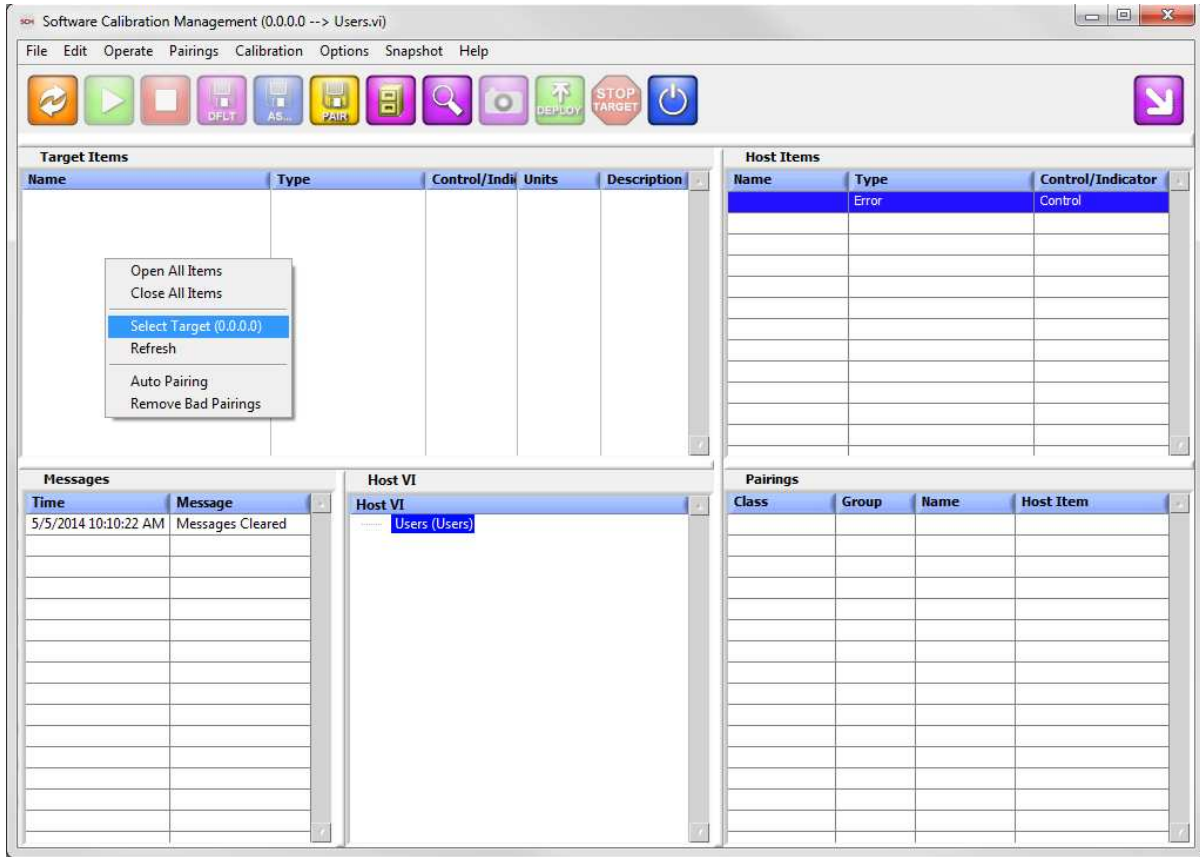

12. A dialog will open titled **Search for SCM Target...** If the Windows PC and the system controller have compatible network settings, then SCM will locate the DI Driver System on the network automatically. A **Download Files** checkbox will be presented within the dialog box and should be checked before pressing the **OK** button. After pressing OK, SCM will take about 30 seconds to download several files from the DI Driver System, including the user interface windows. SCM will store these files in the Windows user "Documents\LabVIEW Data\SCM Data" directory. The location of these files, and the IP address of the system controller, will be remembered on each successive opening of the SCM console, and are used to establish a connection with the system. Therefore this **Search for SCM Target...** step only needs to be done once or each time the IP address of the system controller is changed.

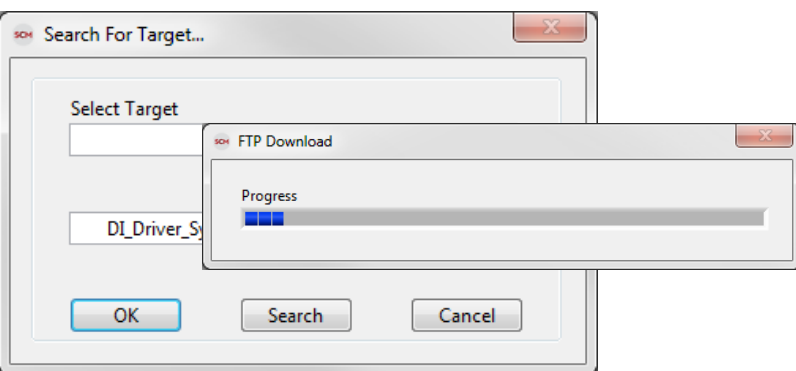

13. After the FTP Download process is complete, the SCM console will be populated with information as shown below. If the Host VI list (lower center) is not populated as shown below, it may be that the FTP download process

did not fully complete. If this is the case, please attempt the **Search for SCM Target...** step again. If the FTP download process fully completes, **the green run button** (2nd from left) will be enabled.

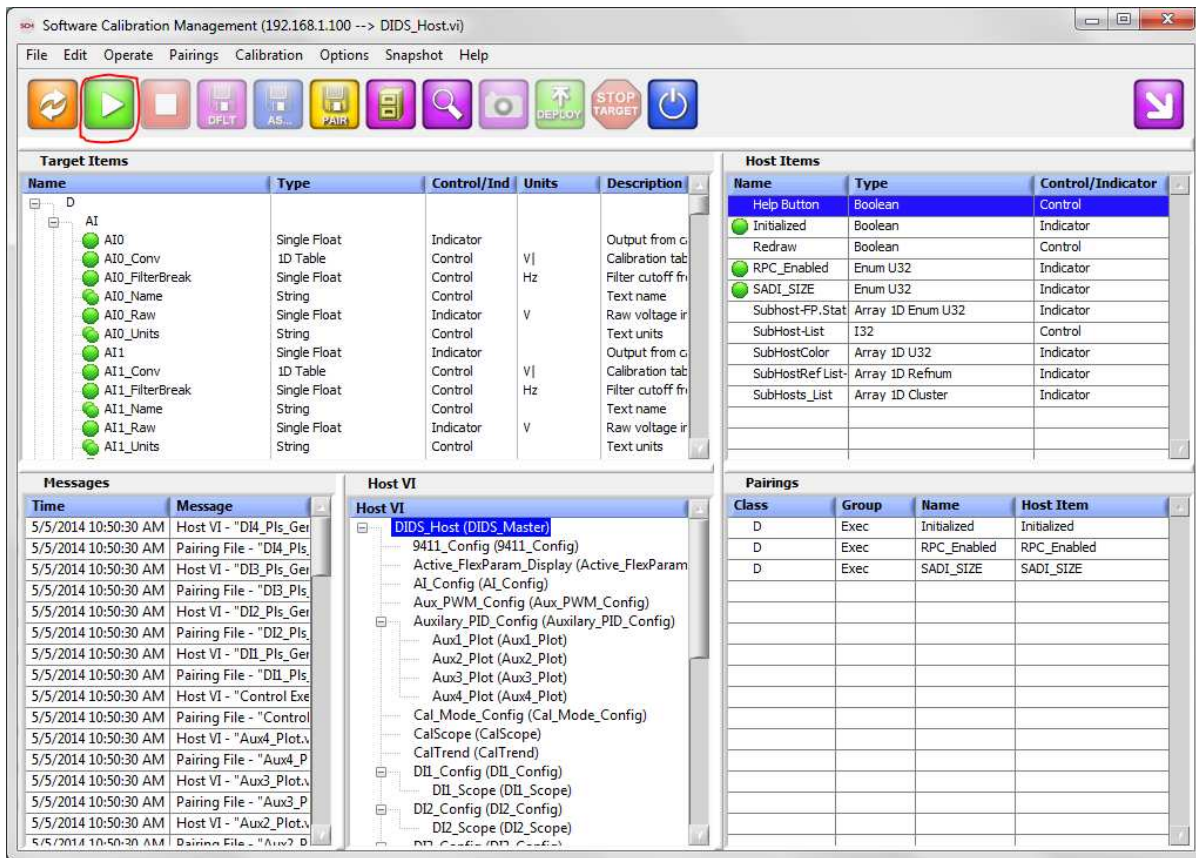

14. Press the **green run button** (2nd from left) to start the DI Driver System main user interface. The main user interface window contains a list of all setup windows used to configure the various DI Driver System functions. Double-clicking on a setup window name will open the window and make the listed name bold. Multiple setup windows may be open simultaneously. Pressing the **X** in the upper right corner of each window will close the window. Also, double clicking the bolded window name within the main window list will close the window. A single click of a bolded window name will bring the selected window to the top with focus. Pressing the **X** in the upper right corner of the main user interface window, or pressing the **red square button** in the SCM console (3rd from left) will close all open setup windows and stop user interface communications with the DI Driver System. However, the system will still continue to operate according to the most recent user interface settings. The user interface can be started again by pressing the green run button within the SCM console.

The DI Driver System can operate automatically, when powered up, according to settings saved to a system calibration file. The calibration file can be saved while the user interface is open by pressing the **purple default calibration save button** from the SCM console (4th from left). The default save function will save all current settings within the setup windows to the default calibration file. The default calibration file is located on the DI Driver System controller at "C:\system\ni-rt\LabVIEW Data\DefaultCal.cdl". The file system of the DI Driver System controller can be browsed using an FTP client. A recommended FTP client is [FileZilla](#). It is not recommended to use the FTP connection within the Windows file Explorer.

Please refer to the [NI Direct Injector Driver System Interface](#) for documentation of the parameters in the setup windows.

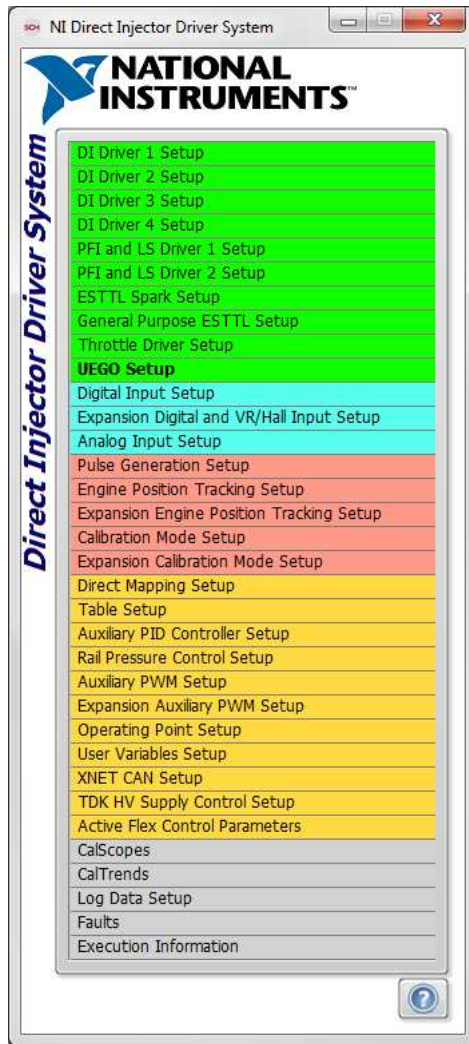

15. If it is desired to change the network settings of the DI Driver System controller, refer to [Changing The Network Settings Of The DI Driver System](#).

3.2.3.2 Changing The Network Settings Of The DI Driver System

This section assumes that a connection with the DI Driver System user interface is already established, and it is desired to change the IP address. If a connection has never been established, please refer to [Out Of The Box Connection](#). If the IP address of the DI Driver System is unknown and a connection with the user interface cannot be established, please refer to [Setting the Controller Network Interface To DHCP](#).

1. After starting the system main user interface, double-click on the [Execution Information](#) window.



- 2.) After the **Execution Information** window opens, select the **Network** tab to make changes to the controller network settings. The settings shown on this tab are similar to the **Windows PC LAN TCP/IPv4 Properties** dialog. The image below shows an example of changing the controller IP address to 192.168.2.34.

The Default Gateway and DNS Server IP addresses may be important if the system is connected to a network router. A network administrator should be contacted for this information. If a direct, "point-to-point" network connection is made between the Windows PC and the system controller, both Default Gateway and DNS Server addresses may be set to 0.0.0.0.

The Windows PC used to interface with the system must have a similar IP address and Subnet mask as the system controller, but the IP address must be different in the last address number.

If the Windows PC and the system controller are placed in DHCP mode and connected to a network router acting as a DHCP server, then both devices will be served IP addresses on the same subnet automatically.

If the system controller must be served an IP address from a router automatically, then select the **Obtain an IP address automatically** radio button. This will cause the other IP address settings to be disabled, and the controller's network interface will be placed in DHCP mode. NI does not recommend using DHCP mode for the DI Driver System controller because the IP address may change each time the system is powered. Each time the IP address changes, the [Search for SCM Target...](#) dialog must be opened within the SCM console to locate the system on the network. If the system controller network interface is in DHCP mode, and the controller is not connected to a DHCP router, the controller will default to a link-local IP address of 169.254.X.X. If this happens, a connection with the system can still be established via direct, "point-to-point" if the Windows PC LAN IP address is configured to a similar IP address, but different in the last address number.

After making changes to the network settings, select the **Apply Change** button associated with the changed settings.

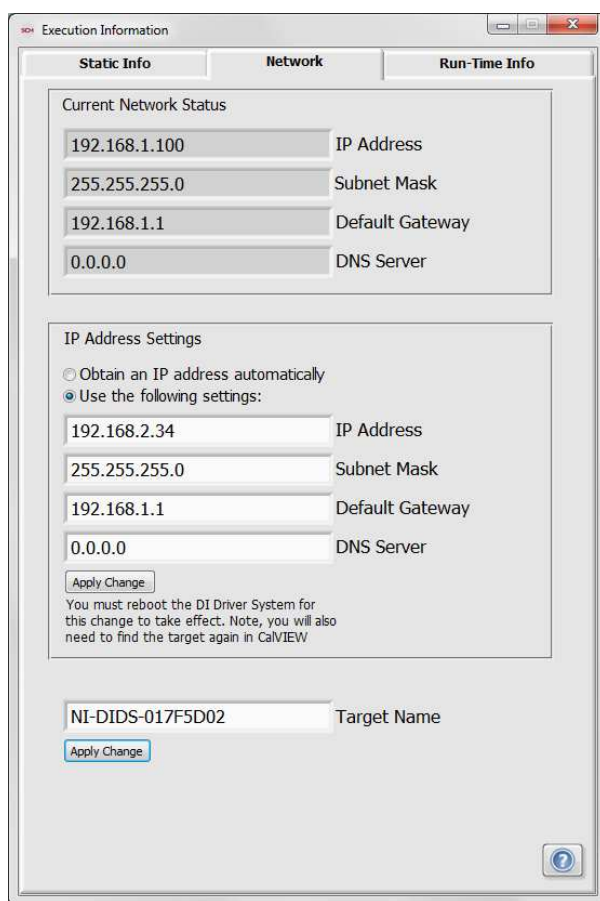

3. Reset the controller, or cycle the controller power, to reboot the system. Wait for the **USER1** and **USER FPGA1** LEDs to start blinking before performing the [Search for SCM Target...](#) step.

3.2.3.3 Manually Resetting The Controller Network Interface To DHCP

This section assumes that all attempts have failed to establish connection with the DI Driver System user interface, and the system controller IP address is unknown.

Before resetting the controller network settings to DHCP mode, consider the following:

1. Reboot the System Controller

Press and release the reset button on the front of the [cRIO-9082](#) controller. Wait about 1 minute for both the USER1 and USER FPGA LEDs to start blinking. The typical time to start blinking is about 25 seconds. A connection cannot be established with the user interface via SCM until both User LEDs are blinking. If both LEDs are not blinking, refer to the [Troubleshooting](#) section.

2. Use [Search for SCM Target...](#) to Discover the IP Address

If the IP address of the controller is discovered via the Search for SCM Target... dialog, but the Download Files checkbox does not appear in the dialog, then take note of the discovered IP address. The Windows PC used to interface with the system must have a similar IP address and Subnet mask as the system controller, but the IP address must be different in the last address number. The Subnet mask should be 255.255.255.0. Refer to the [Out Of The Box Connection](#) section to see how to change the IP address of the Windows PC.

3. Use SCM Real-Time Target Backup Feature to Discover the IP Address

From the SCM console, select File, then **Real-Time Backup and Restore** to open the **Real-Time System Backup** dialog. Select the **Backup Real-Time System** button to open the Backup Target dialog.

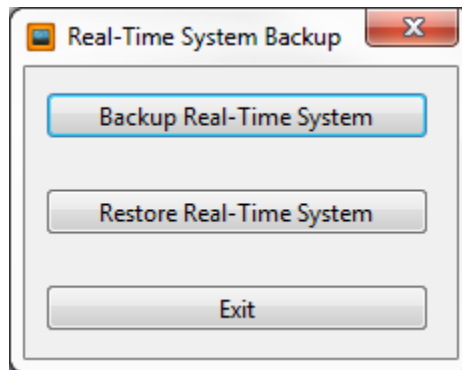

Select the **Browse** button to open the **Select RT System** dialog.

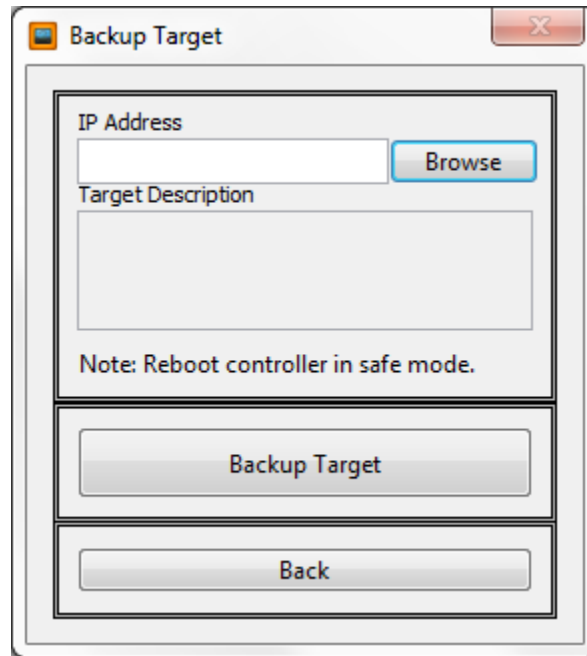

This will cause SCM to search the network for a National Instruments RT controller, such as the **cRIO-9082**. If the DI Driver System controller is discovered, take note of the discovered IP address. The Windows PC used to interface with the system must have a similar IP address and Subnet mask as the system controller, but the IP address must be different in the last address number. The Subnet mask should be 255.255.255.0. Refer to the [Out Of The Box Connection](#) section to see how to change the IP address of the Windows PC. The **Select RT System** dialog may be exited by selecting the **Cancel** button. The **Backup Target** dialog may be exited by selecting the **Back** button. The **Real-Time System Backup** dialog may be exited by selecting the **Exit** button.

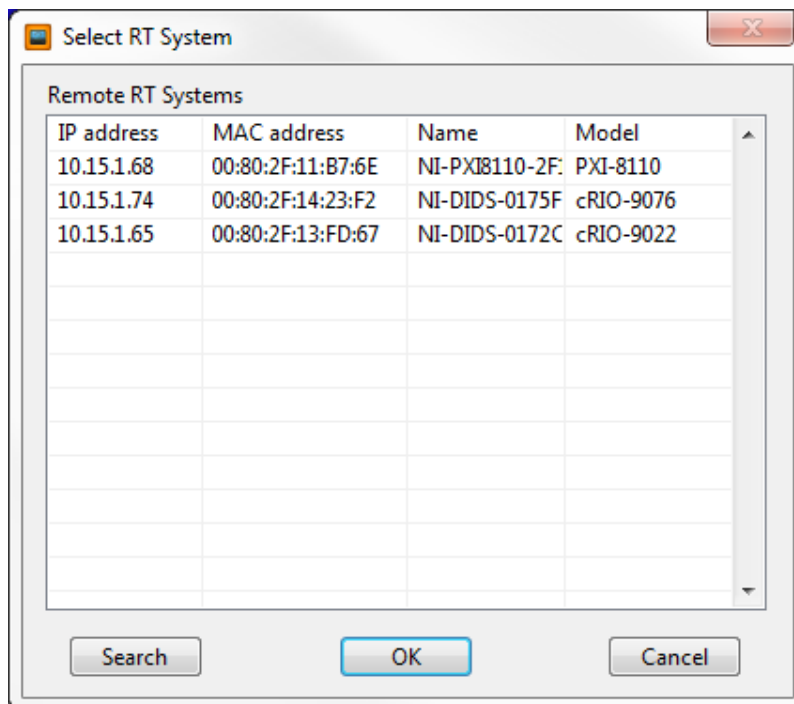

4. Check the System Controller Ethernet Cable Connection

If the green and amber LEDs directly under the controller Ethernet port are not active or blinking, then there is no physical connection to a network router or PC, or there is no power to the controller. Please diagnose the Ethernet cable connection or controller power problem.



If none of the above suggestions resolve the system connection problem, follow the instructions below to reset the system controller network interface settings to DHCP.

cRIO-9082 Controller

To manually reset the network settings of the cRIO-9082 controller included with 3-, 6-, 9-, and 12-channel DI Driver Systems, follow the steps below:

1. Power up the cRIO-9082 controller.
2. Switch the **IP RESET** switch to **ON**.
3. Press and immediately release the **reset** button. This will cause the controller to reboot normally and start the DI Driver System software. However, the network settings will be reset to DHCP mode. Wait about 1 minute for both the USER1 and USER FPGA1 LEDs to start blinking.
4. Switch the **IP RESET** switch to **OFF**.



Note: NI does not recommend leaving DHCP mode for the DI Driver System controller because the IP address may change each time the system is powered. Each time the IP address changes, the **Search for SCM Target...** dialog must be opened within the SCM console to locate the system on the network. If the system controller network interface is in DHCP mode, and the controller is not connected to a DHCP router, the controller will default to a link-local IP address of 169.254.X.X. If this happens, a connection with the system can still be established via direct, "point-to-point" if the Windows PC LAN IP address is configured to a similar IP address, but different in the last address number. If the system controller is allowed to default to the link-local address, follow the instructions above for **Use SCM "Backup Target" Feature to Discover the IP Address** to identify the exact link-local IP address.

3.2.3.4 SCM and Windows Firewall

After installing SCM, if Windows Firewall is enabled, SCM should be added to the list of Allowed Programs to communicate through the Windows Firewall. Since SCM must communicate with the DI Driver System via a Ethernet LAN port, it is important that Windows Firewall be configured to allow SCM, and its associated programs, access to the network. SCM and its associated programs use UDP, TCP/IP, and FTP protocols. Sometimes, certain Windows settings prevent SCM from being added to the Allowed Programs list. The Allowed Programs list can be checked by following the instructions below.

The PC used for interfacing with the DI Driver System may have the Windows Firewall turned off. In this case, the Allowed Programs list is not applicable and does not need to be checked. If the Windows Firewall is turned on, it may be possible to turn it off, if allowed by the network administrator.

Some PCs may use a different software firewall other than Windows Firewall and will need to be configured properly to allow SCM to communicate with the DI Driver System IP address via UDP, TCP/IP, and FTP protocols.

Checking the Windows Firewall Allowed Programs List

The Windows Firewall configuration can be opened by going to the Windows Start menu and entering "Windows Firewall" in the search field.

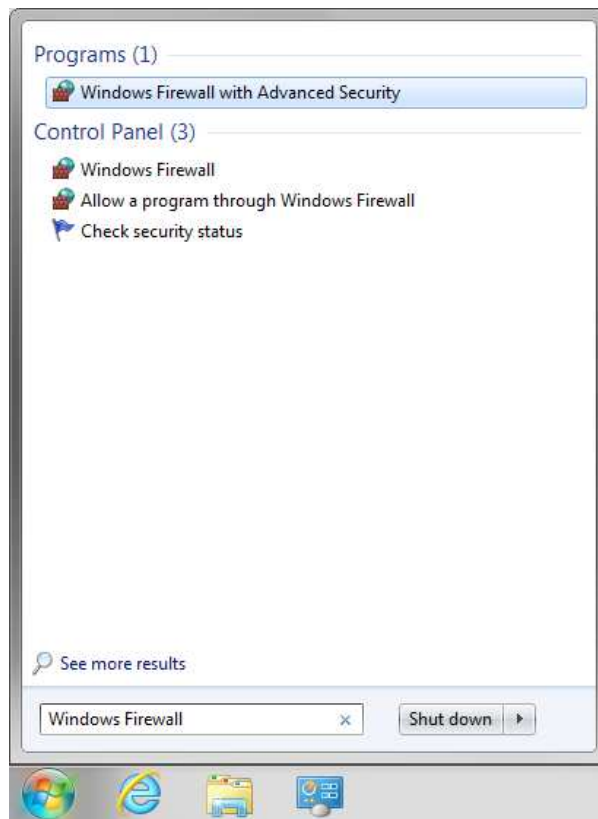

Select **Windows Firewall** from the Start Menu search results to open the configuration window. The screen shot below is a general representation of what may be seen if the Windows Firewall is on.

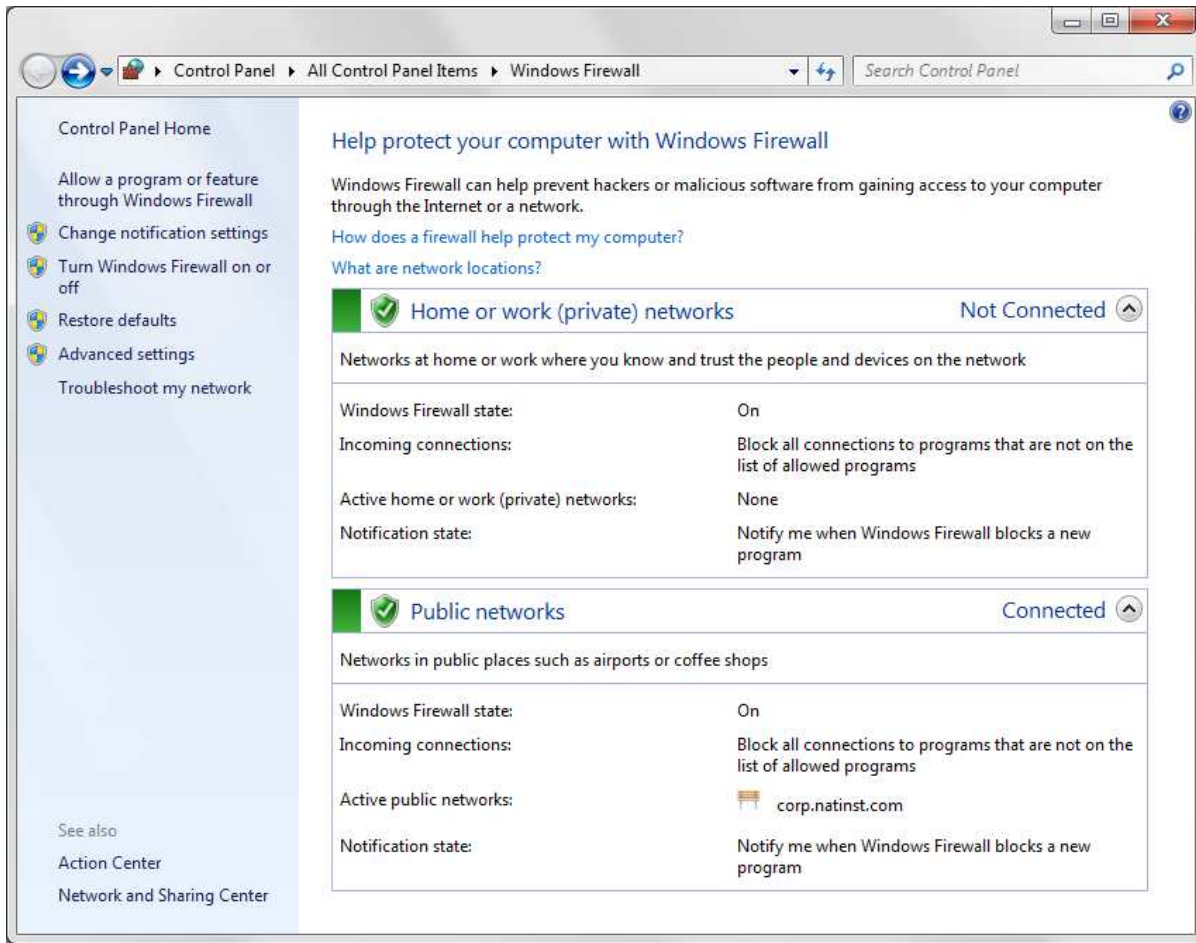

If Windows Firewall is on, and it is desired to turn it off, select **Turn Windows Firewall on or off** from the left menu and select the radio buttons as shown below.

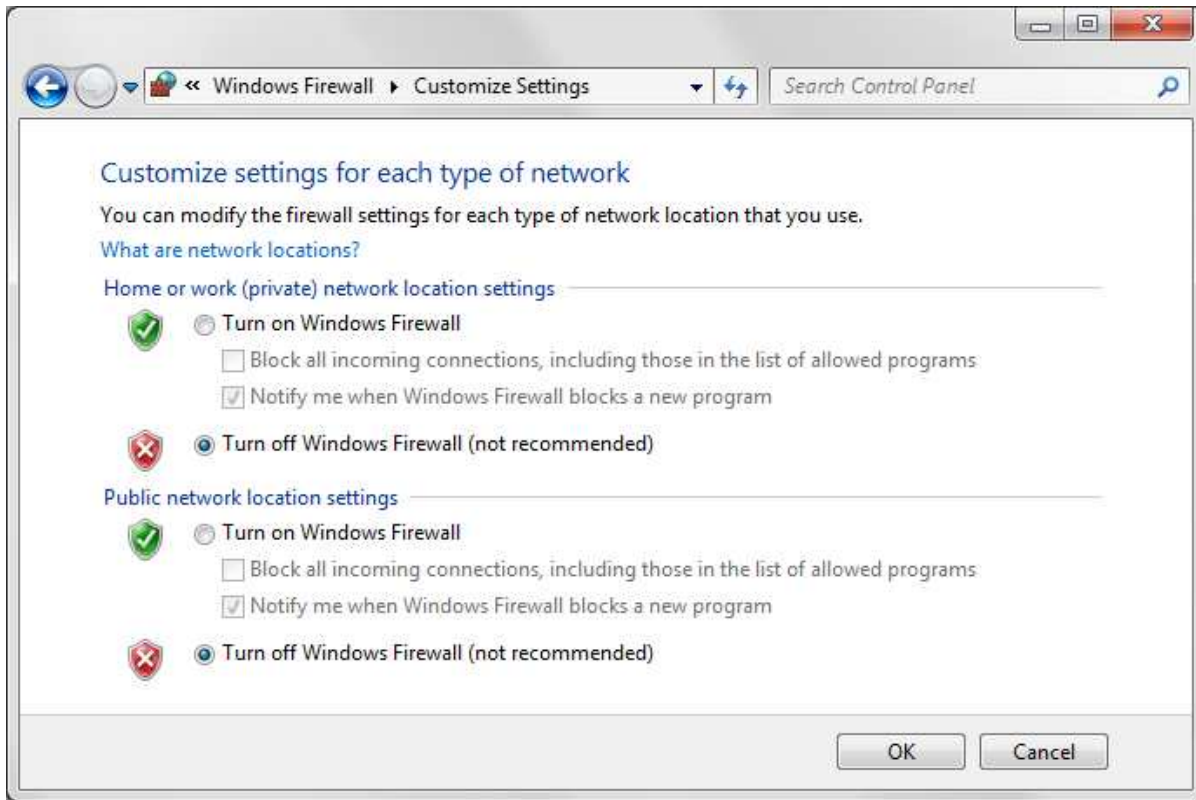

To check the list of Allowed Programs, return to the main Windows Firewall window and select **Allow a program or feature through Windows Firewall** from the left menu.

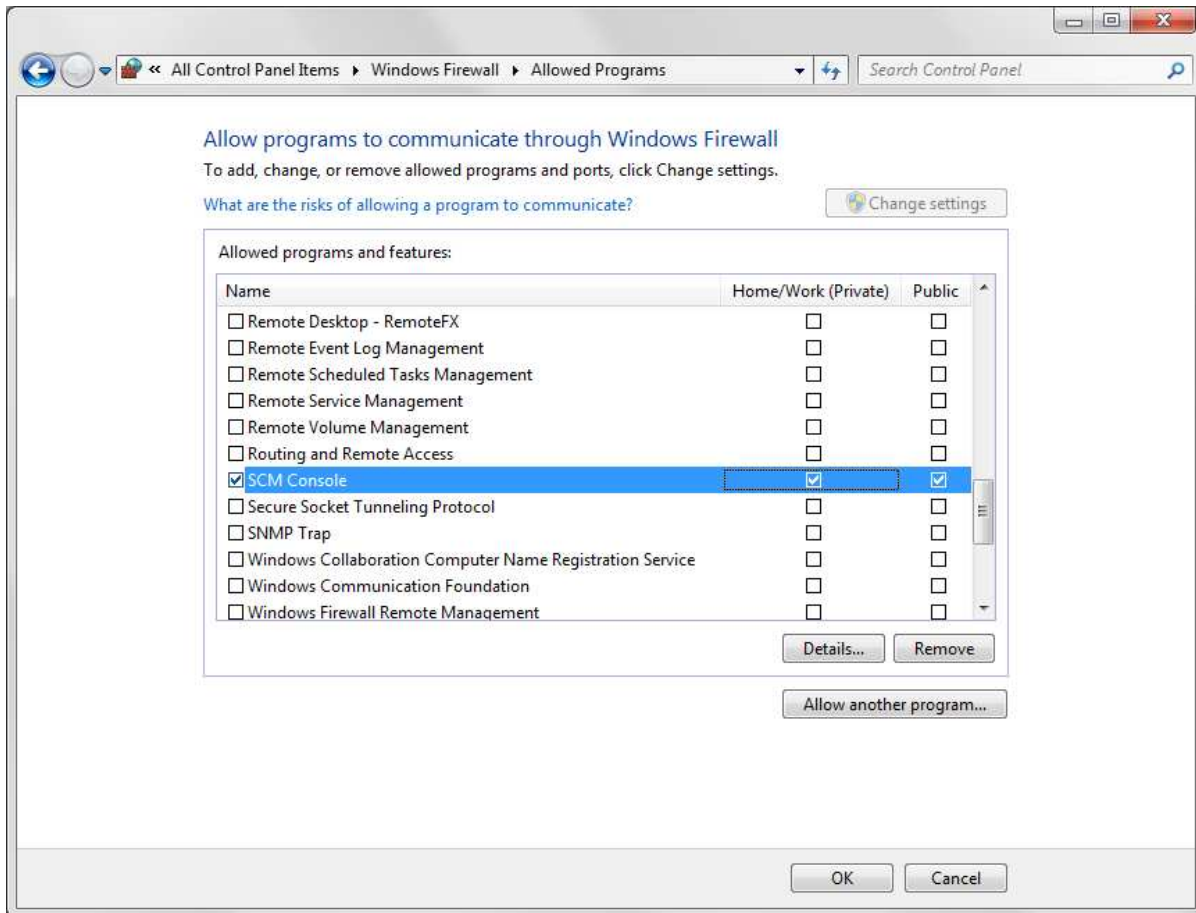

Scroll through the list of programs and look for the following programs:

- SCM Console
- NI Backup and Restore
- NI SCM Calibration Difference
- NI SCM Calibration File Manager
- NI SCM Fault Display

Confirm that both **Home/Work (Private)** and **Public** check boxes are checked. Select **OK** and close the Windows Firewall window.

If the above programs are not in the list, select **Allow another program...** to open the **Add a Program** dialog to add each of the programs. After adding the programs, confirm that both **Home/Work (Private)** and **Public** check boxes are checked.

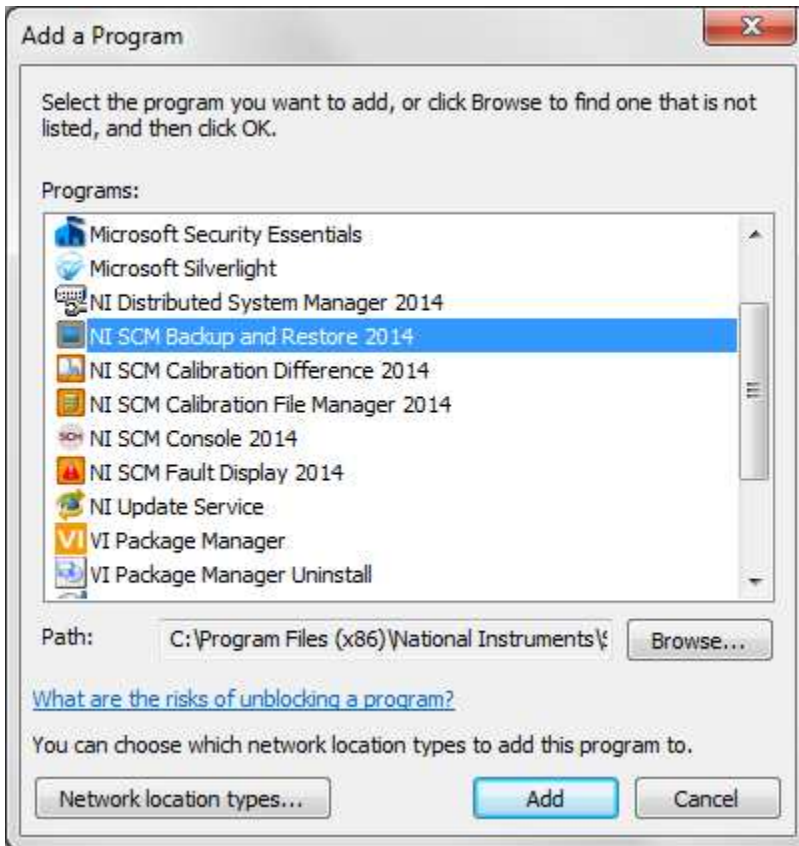

3.2.4 Updating DI Driver System Controller Software

Occasionally NI will generate updates to the DI Driver System controller software and provide a link to the latest update software on the [DI Driver System product page](#). The software update is provided in the form of a .upd file downloaded in a .zip file and is a complete hard drive image replacement for the cRIO controller.

NI provides an updater utility for download from the [DI Driver System product page](#). The utility is called the DI Driver System Updater and is provided in the form of a .zip file, along with the .upd file. The zip file contains a .exe file which must be executed on the same Windows PC where SCM is installed.

***Note:** The .zip file downloaded contains both the .exe and .upd files.

The software update utility and associated .upd files are only compatible with existing DI Driver Systems using cRIO-9082 controllers. A software update cannot be performed on new cRIO controllers without a working copy of the DI Driver System software.

NOTE: The system controller network interface settings are not changed by updating the software image. **The DI Driver System must be in static IP address mode for the update to restore correctly. For more information on changing your system to static IP mode see [Changing The Network Settings Of The DI Driver System](#).**

To update the DI Driver System controller software, following the instructions below:

1. Take note of the DI Driver System software version on the Static Info tab of the [Execution Information](#) window of the user interface.
2. Using a web browser, navigate to the [DI Driver System product page](#) and check the version of the software update. If the software update is a later version than the currently running software, download it to the PC.
3. Download the updater utility zip file to the PC and unzip it to produce the executable.
4. Run the **DI Driver System Updater** utility to see the dialog shown below.

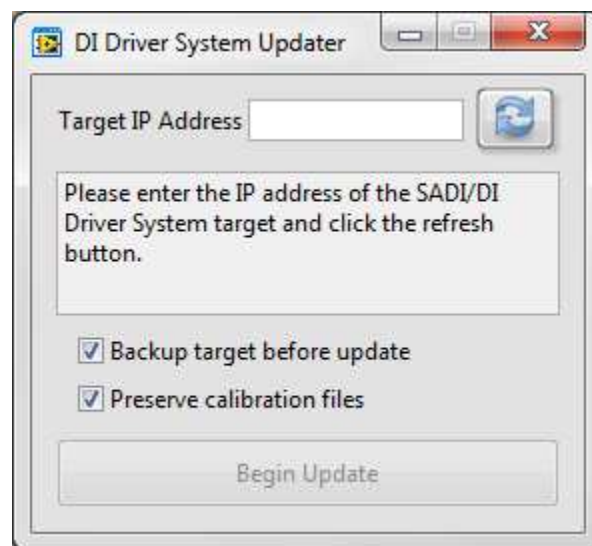

5. Enter the IP address of the DI Driver System in the **Target IP Address** field. Press the **refresh** button to the right. The information window in the middle of the dialog will provide information about the controller discovered at the

specified IP address. If the controller at the specified IP address is valid, then the **Begin Update** button at the bottom will be enabled.

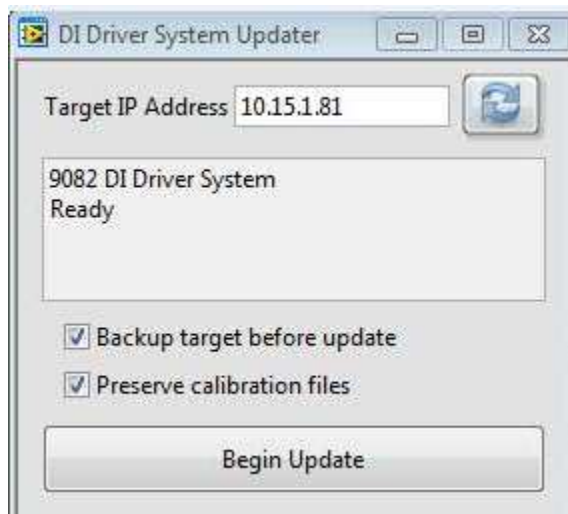

6. Two options are available for selection before beginning the update process.

a. **Backup target before update:** This option may be selected if it is desired to create a backup image of the system controller before updating the software to the latest version. If selected, a Zip file save dialog will open to select the path and name of the backup zip file to be saved.

b. **Preserve calibration files:** This option may be selected if it is desired to preserve the current calibration files on the system controller. Otherwise the current calibration files on the system controller will be overwritten during the software update process.

7. Press the "Begin Update" button at the bottom to start the software update process. The process will take about 5 to 10 minutes. During the update process, the cursor will show as busy while hovered over the dialog. When the process completes, a beep sound will be generated and the controller will be rebooted. Wait for the **USER1** and **USER FPGA1** LEDs to start blinking and then use the **Search for Target...** feature of SCM to reconnect to the controller and download the new user interface files from the controller. It is important to check the **Download Files** check box within the **Search for Target...** dialog in order to have the user interface files compatible with the updated system software.

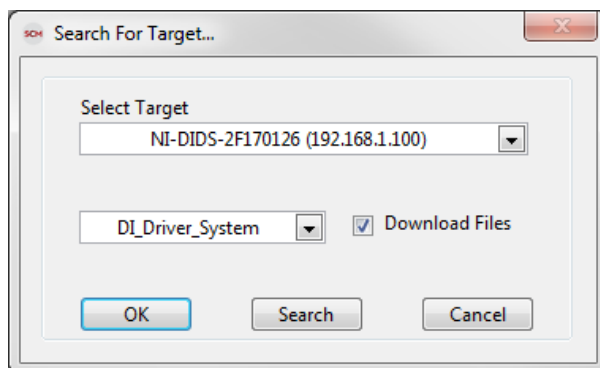

3.2.5 Backing Up the DI Driver System Software Image

A DI Driver System software backup image can be created by following the instructions below. It is recommended this procedure be performed after the system has been calibrated and ready for deployment.

***Note: The DI Driver System must be in static IP address mode for the backup to restore correctly. For more information on changing your system to static IP mode see [Changing The Network Settings Of The DI Driver System](#).**

1. Open the SCM console and select **Backup Target** from the **File** menu to open the **Real-Time System Backup** dialog.

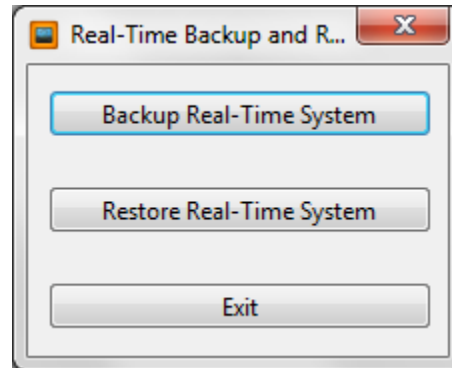

2. Select the **Backup Real-Time System** button to open the **Backup Target** dialog. Select the **Browse** button to open the **Select RT System** dialog.

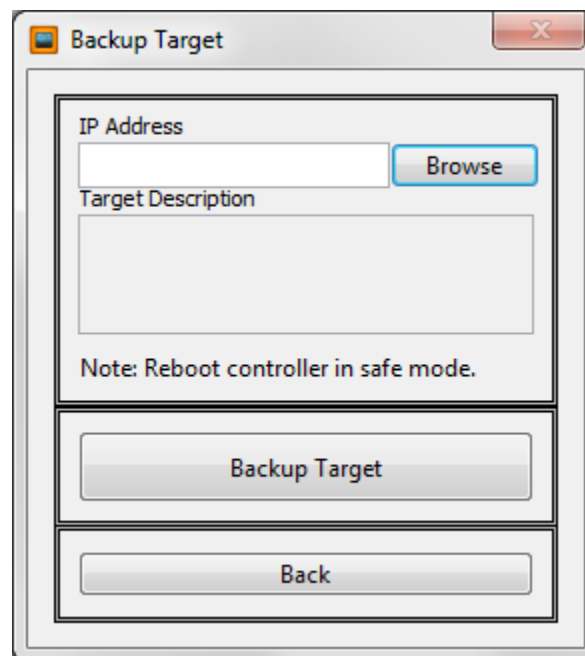

3. This will cause SCM to search the network for a National Instruments RT controller, such as the cRIO-9082. Select the line associated with the system. Press OK to close the dialog and return to the **Backup Target** dialog.

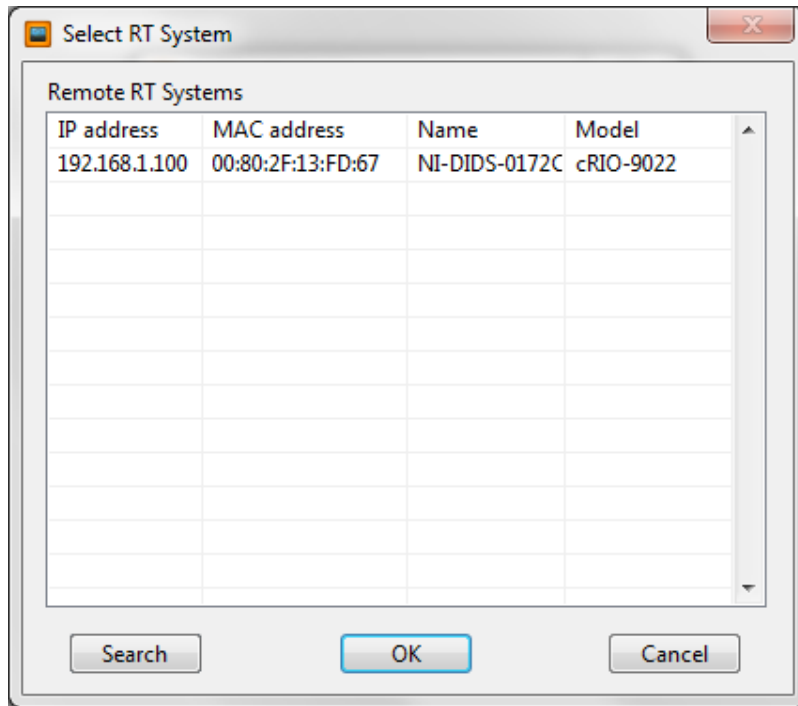

4. The selected target IP Address should be listed in the **IP Address field** and additional target information will be shown in the **Target Description** field.
5. In the lower half of the **Backup Target** dialog, press the **Backup Target** button to browse the PC to specify the location to save the DI Driver System software image zip file. Select **OK** to close the location selection dialog.
7. During the image backup process, the PC cursor will indicate busy while hovering over the **Backup Target** dialog. The process will take about 3 minutes.
8. When the backup process is completed, press the **Back** button to close the **Backup Target** dialog to return to the **Real-Time System Backup** dialog.
9. Press the **Exit** button to close the **Real-Time System Backup** dialog.

3.2.6 Restoring A Backup Image To The DI Driver System Controller

If the **USER1** and **USER FPGA1** LEDs are not blinking at all, please try pressing and immediately releasing the controller **reset** button. Wait 1 minute for the LEDs to start blinking. If they do not start blinking, follow the instructions below for restoring a backup image zip file to the system controller. If a system backup image is not available, please contact the National Instruments support team.

A DI Driver System software backup image can be created by following the instructions in [Backing Up the DI Driver System Software Image](#) section. It is recommended this procedure be performed after the system has been calibrated and ready for deployment.

WARNING: Restoring a software image to the system controller will overwrite the entire system hard drive. If a critical calibration file is stored on the controller, it should be retrieved before restoring the backup image. Step 1 below provides the optional instructions for retrieving the calibration file.

NOTE: The system controller network interface settings are not changed by restoring the software image. **The DI Driver System must be in static IP address mode for the backup to restore correctly. For more information on changing your system to static IP mode see [Changing The Network Settings Of The DI Driver System](#).**

1. Using an FTP client, connect to the DI Driver System controller and browse to “C:\ni-rt\LabVIEW Data\”. Copy any .cdl calibration files from the cRIO controller to the PC for backup. The default calibration file is named DefaultCal.cdl. This is important because the image restoration process will overwrite all files on the controller. This step is only necessary if calibration files have previously been saved and contain important system settings.
2. Open the SCM console and select **Backup Target** from the File menu to open the **Real-Time System Backup** dialog. Press the **Restore Real-Time System** button to open the **Restore Target** dialog.

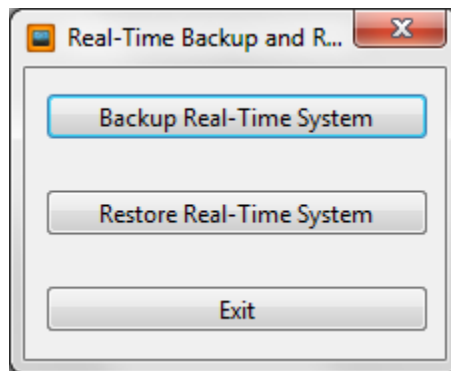

3. Press the **Browse** button to open the **Select RT System** dialog to allow SCM to find the system on the network.

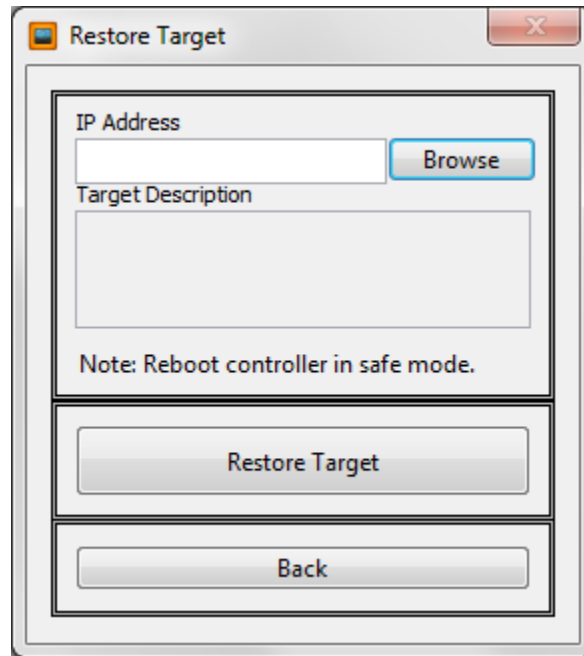

4. Select the line associated with the system. Press **OK** to close the dialog and return to the **Restore Target** dialog.

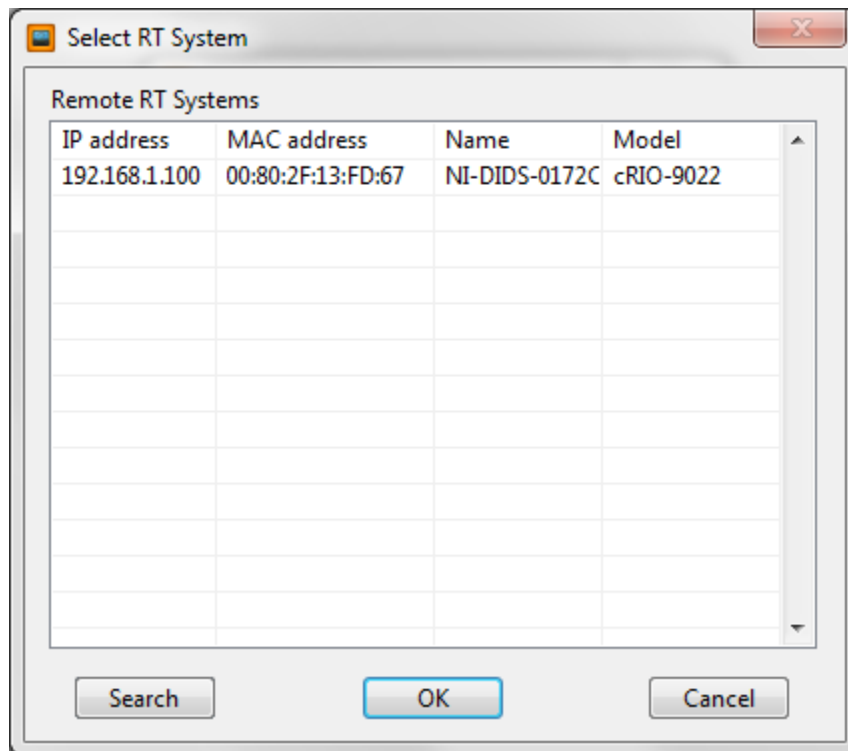

5. The selected target IP Address should be listed in the **IP Address** field and additional target information will be shown in the **Target Description** field.

6. In the lower half of the **Restore Target** dialog, press the **Restore Target** button to browse the PC for the DI Driver System software image zip file. Select the zip file and press **OK**.

8. During the image restoration process, the PC cursor will indicate busy while hovering over the **Restore Target** dialog. The process will take about 3 minutes.
9. When the restoration process is completed, press the **Back** button to close the **Restore Target** dialog to return to the **Real-Time System Backup** dialog.
10. Press the **Exit** button to close the **Real-Time System Backup** dialog.
11. After the image restoration process, the DI Driver System will be rebooted automatically. Wait for the **USER1** and **USER FPGA1** LEDs to start blinking, indicating the DI Driver System application is running.
12. If calibration files were backed up in step 1, use an FTP client to restore any .cdl calibration files. The .cdl calibration files on the system controller should be located at "C:\ni-rt\LabVIEW Data\". After restoring the calibration file, reset the controller or cycle the power.

3.3 Hardware

3.3.1 C-Series Module Slot Assignments

NI EDIDS-2403, EDIDS-2406, NI EDIDS-2409, and NI EDIDS-2012 3-, 6-, 9- and 12-Channel Direct Injector Driver Systems

The NI EDIDS-2403, NI EDIDS-2406, NI EDIDS-2409, and NI EDIDS-2412 DI Driver Systems include a 8- slot cRIO-9082 integrated controller. The slot assignments for the NI EDIDS-2403, NI EDIDS-2406, NI EDIDS-2409, and NI EDIDS-2412 DI Driver Systems are shown in figure 3.3.1.a. It is possible to upgrade any system to a NI EDIDS-2412 DI Driver System by adding a NI 9411 and NI 9751 (DI Driver) module(s). System I/O may be expanded with optional NI 9220 and NI 9862 modules (purchased separately). For more information on the hardware included see, [What Is Included](#). The DI Driver System software can only communicate with the modules when they are in their assigned slots shown in figure 3.3.1.a.

The NI 9411 modules can communicate with the any of the DI Driver modules in their appropriate slots. For example, the NI 9411 module in Slot 1: NI 9411_1 has the ability to communicate digital input signals to any of the DI Drivers in Slots 2, 3, 5 or 6. Please note the nomenclature of the DI Drivers and their corresponding slots, as this the identification used in the application interface.

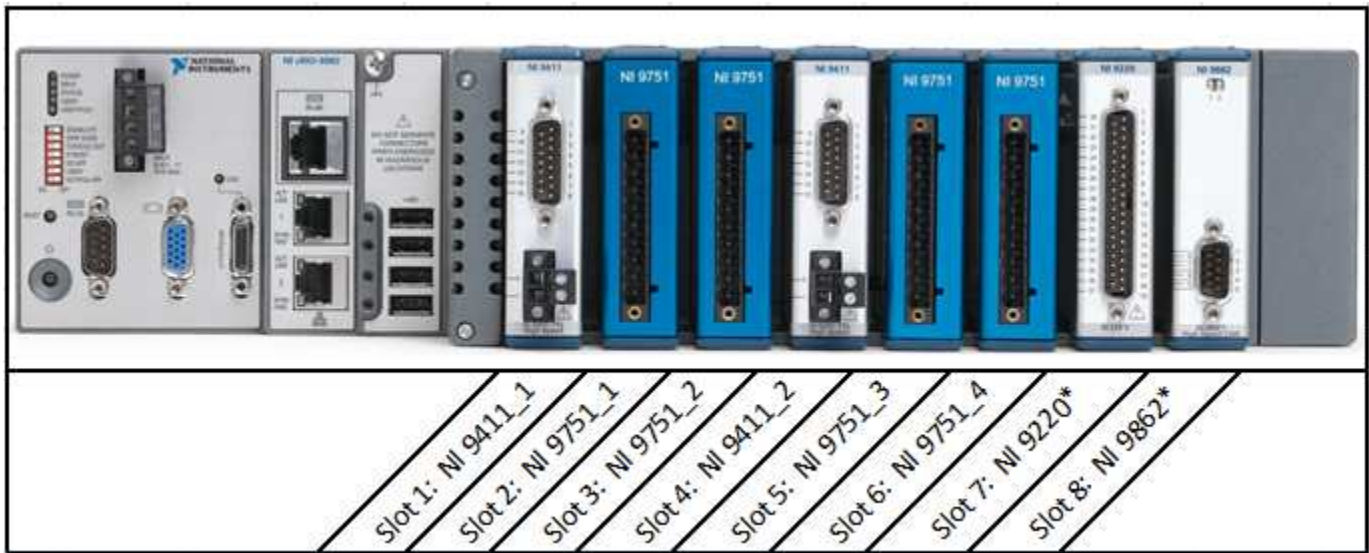

Figure 3.3.1.a, 6-, 9-, and 12-Ch DI Driver System Configuration With Optional NI 9220 and NI 9862 CAN Module

*The NI 9220 and NI 9862 (CAN) modules are optional modules that may be purchased separately. For more information on the functionalities of these modules please see [Using The DI Driver System to Control Fuel Pressure](#).

Module Assignments for NI 9155 MXIe Expansion Chassis

Each NI EDIDS may be expanded with an NI 9155 MXIe expansion chassis to support the additional I/O modules shown below. For more information on the optional expansion I/O modules see, [What Is Included](#).

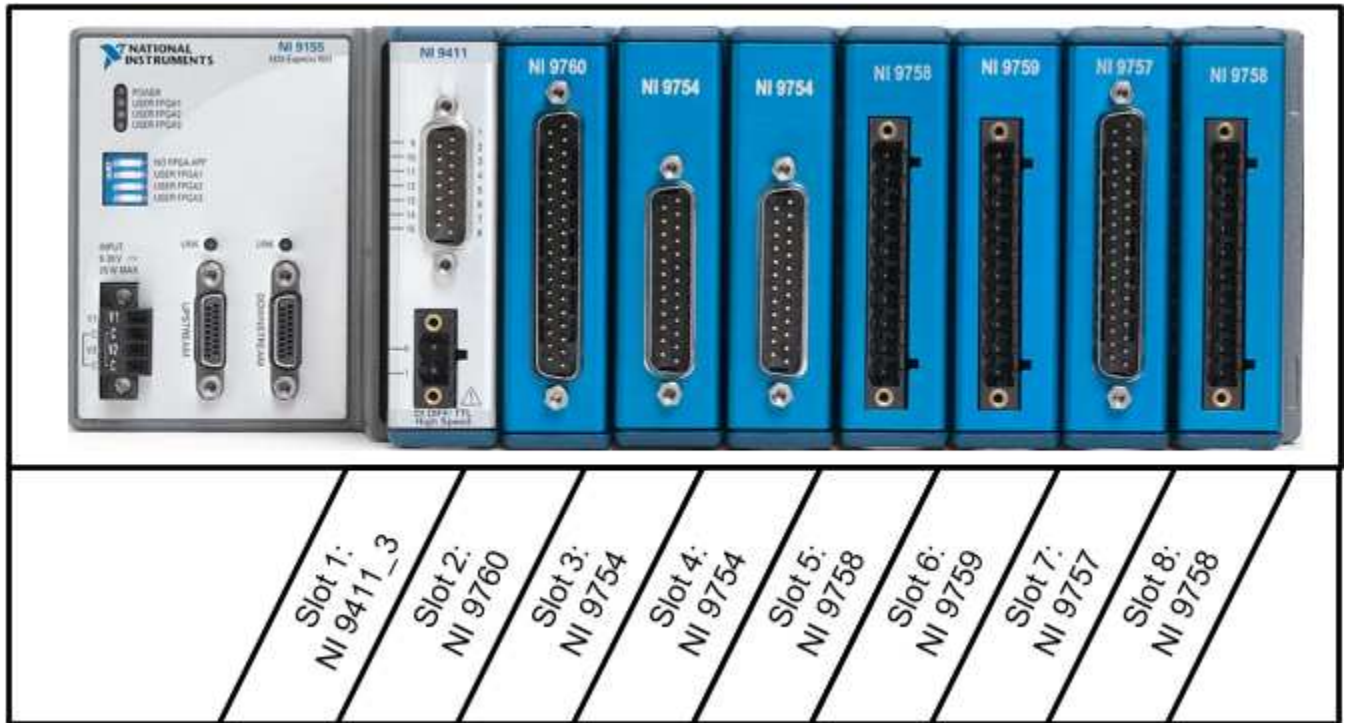

Figure 3.3.1.b NI 9155 MXIe Expansion Chassis With Current Optional Modules

3.3.2 Powering the System

Warning:

The external battery supply input terminals on the NI 9751 (DI Driver) and NI 9758 (PFI Driver) modules are not reverse-voltage polarity protected. Connecting power to the module in reverse polarity will damage the modules. This event is not covered by the warranty. Please refer to the [Reverse Battery Polarity Notice](#) for a recommended solution for protecting a system from reverse battery polarity.

The DI Driver System requires external DC power to the following system components:

Component	Power Terminal Label	Ground Terminal Label	Voltage Range	Maximum Required Power
cRIO-9082 (3,6,9,12-Channel Systems)	V	C	9-30 V	15 W
NI 9155	V	C	9-30V	30 W
NI 9751 Modules 1-4	BATT (0)	GND (9)	9-32 V	75 W Each
NI 9758 Module	BATT (0)	GND (9)	9-32 V	75 W
NI 9759 Module	BATT (0)	GND (9)	9-32 V	75 W
NI 9411 Modules*	Vsup	COM	5-30 V	1 W

3.3.2.a, Power Supply Specifications for I/O Hardware

*The NI 9411 module only needs external power supplied to the screw-terminal block if 5V regulated output power is required from the 15-pin D-Sub connector to an optical encoder. Do not connect external power to the 15-pin D-Sub.

NI recommends the following power supply options for powering the system components:

NI Part Number	Model Number	Input Voltage	Output Voltage	Output Current
783168-01	QS10.121	100-240 VAC	12-15 V	15A
781095-01	PS-17	85-276 VAC	24-28 V	20A

3.3.2.b, Power Supply Recommendations for the DI Driver System

The power supplies listed above are not included with the DI Driver System, but are available through National Instruments. There are a few considerations for selecting the proper power supply system – specifically whether to use a 12V power supply (QS10.121) or a 24V power supply (PS-17). NI recommends using a 24V power supply in order to increase the efficiency of the DI Driver modules' internal boost supply. However, if an optional PFI Driver module is used, and the associated actuators are not rated for 24V, then the lower 12V power supply should be used.

DI Driver Systems with one or two DI Driver modules (EDIDS-2403 and EDIDS-2406) can typically be powered by a single recommended supply listed above. DI Driver Systems with three or four DI Driver modules (EDIDS-2409

and EDIDS-2412) should be powered by two identical supplies wired in parallel. Power supplies wired in parallel will create a supply having the same voltage as the individual supplies, but double the current capacity. [Please refer to the power supply documentation for wiring instructions.](#)

Power Wiring Guidelines

NI recommends powering and grounding each component in the system in a star-wiring configuration, such that each component is wired individually from a single star-point for both positive and negative terminals of the power supply buses. In contrast, it is not recommended to power the components in a daisy-chain configuration because it will cause some modules to experience supply voltage fluctuations.

NI recommends using [crimped ferrules](#) on all wires entering screw terminal connections.

[DI Driver System Component Diagrams and Connector Pinouts](#)

3.3.3 Connecting Injectors, Sensors and Actuators

3.3.3.1 Direct Injectors to DI Driver Channels

Connecting Direct Injectors to the Direct Injector (DI) Driver Module

Direct injectors have two pins or wire leads. For solenoid injectors, the polarity of the injector leads typically does not matter. However, the polarity does matter for piezo injectors. Each DI Driver module has three channels and provides a positive and negative terminal for each channel labeled INJX+, where “X” represents the channel number. Solenoid and piezo injectors cannot be mixed within a DI Driver module. The DI Driver module supports three channels for solenoid injectors and two channels for piezo injectors. When the module is configured for piezo mode, channels 1 and 2 are available as driver channels, while channel 3 is unavailable and must be wired with a shorting jumper across the positive and negative terminals.

Solenoid Injector Wiring

Typical wiring for solenoid injectors to a DI Driver module is shown in figure 3.3.3.1.a.

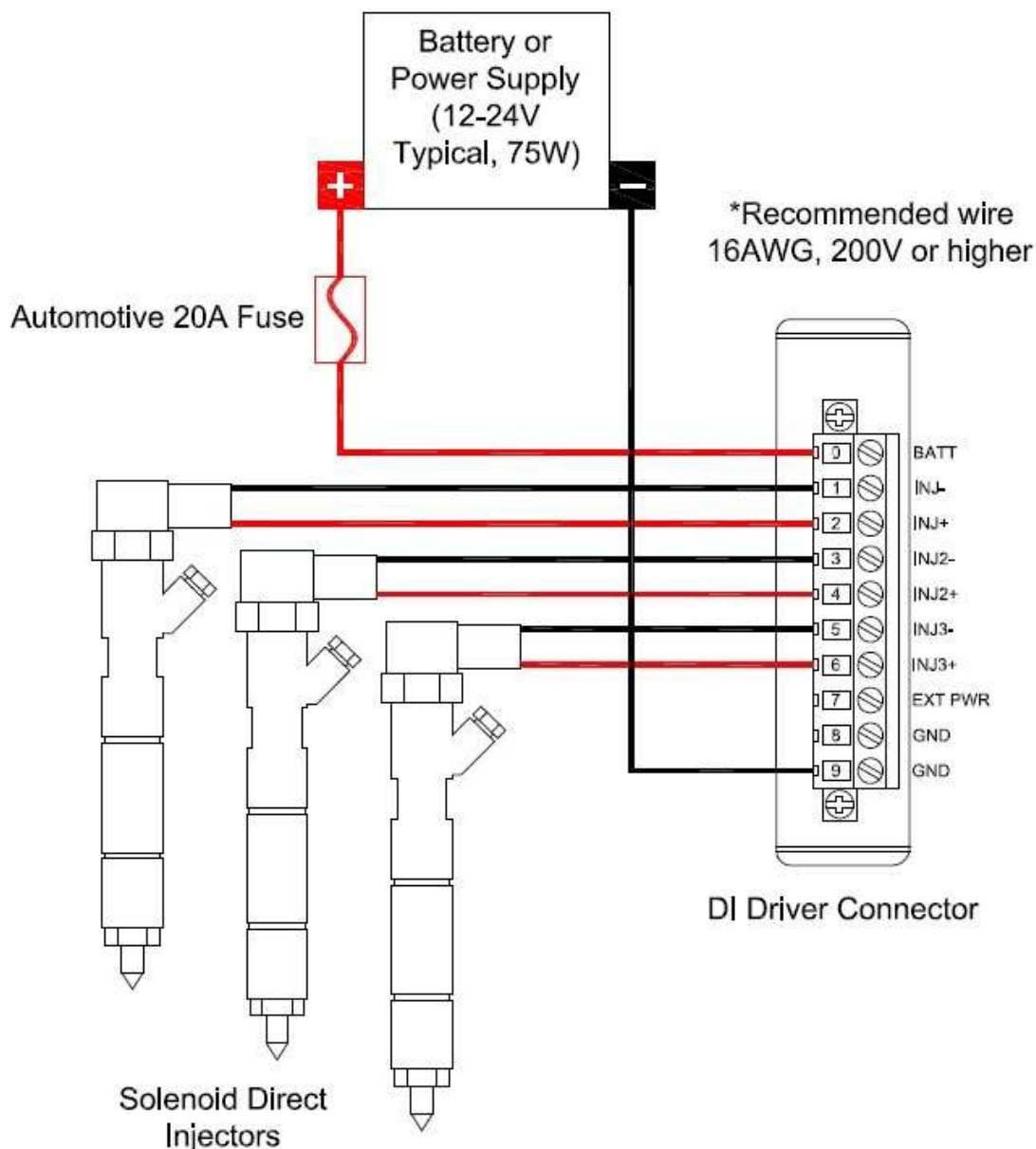

Figure 3.3.3.1.a, Diagram of Typical Wiring of Solenoid Injectors to a DI Driver Module

Piezo Injector Wiring

Driving piezo injectors requires in-series inductance on the high side wire (INJX+ wire) and shorting of channel 3. Shorting channel 3 is required to discharge the piezo actuator of channel 1 and channel 2. This means that each DI Driver module can only operate two (2) channels of piezo injectors.

NI provides [two \(2\) piezo inductors](#) per DI driver module in a DI Driver System order.

Typical wiring for piezo injectors to a DI Driver module is shown in figure 3.3.3.1.b.

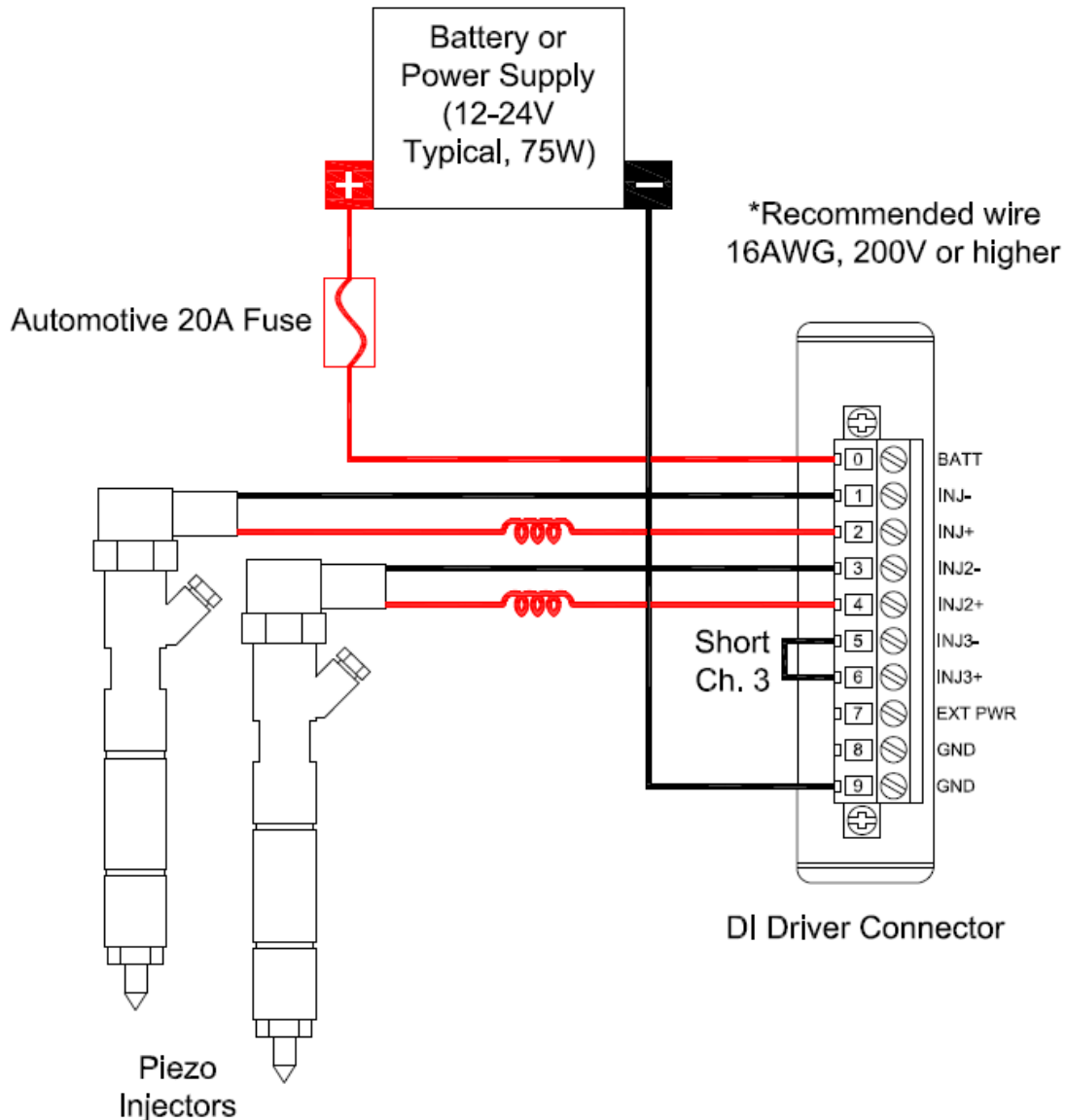

Figure 3.3.3.1.b, Diagram of Typical Wiring of Piezo Injectors to a DI Driver Module

3.3.3.2 Port Fuel Injectors to PFI Channels

The DI Driver System supports an optional PFI Driver module. The PFI Driver module has four channels, PFI1 – PFI4, for driving port fuel injectors. Each PFI driver channel is capable of driving low or high impedance port fuel injectors.

Driving Low Impedance Injectors

Low impedance injectors will have approximately 2 ohms resistance across the solenoid. The low resistance allows higher current through the solenoid to enable faster valve opening times. However, the high current is not needed for the entire duration of the injection event in order to keep the valve open. The initial current level is referred to as the peak current phase and the current level for the remaining injection duration is referred to as the hold current phase. Typically, the peak current phase is 4A and the hold current phase is 1A.

Driving High Impedance Injectors

High impedance injectors will have approximately 12 ohms resistance across the solenoid. Typically, less than 1 amp is required to open and hold the solenoid valve. Only one current control phase is required to operate high impedance injectors at a constant current level.

Refer to the [PFI & LS Driver Setup Window](#) for detailed information on configuring PFI Driver channels.

Wiring diagram for up to four port fuel injectors to the PFI channels of the PFI Driver module is shown in diagram 3.3.3.2.a. (NI recommends using 18 AWG wire (or larger) for port fuel injectors.)

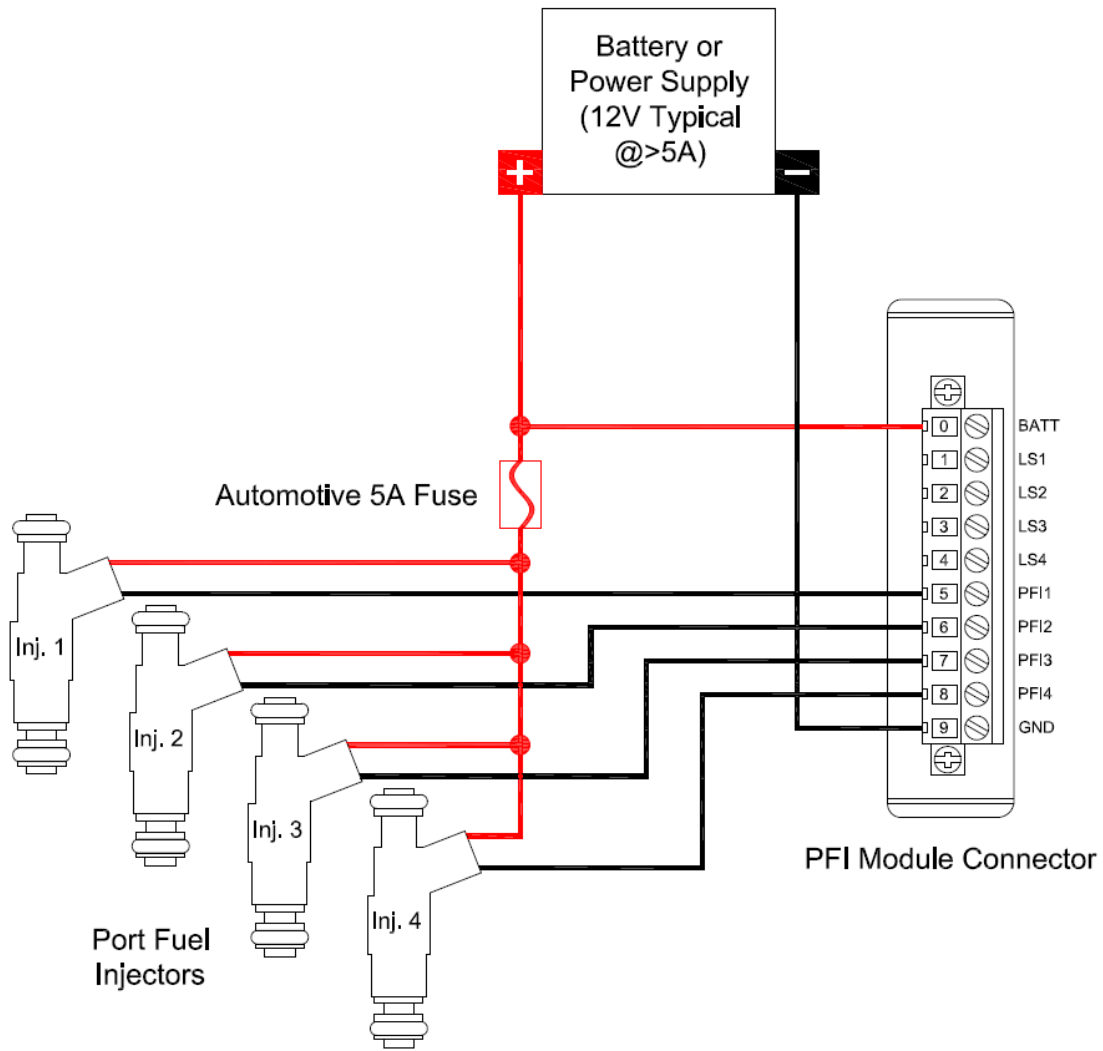

Figure 3.3.3.2.a, Diagram of Typical Wiring of Port Fuel Injectors to a PFI Driver Module

3.3.3.3 Proportional Solenoid Valves to PFI Lowside Channels

The lowside drivers of the PFI Driver module are capable of driving a wide variety of automotive relays and proportional solenoid valves. Examples of actuators include EGR valves, turbocharger wastegate valves, fuel pressure regulators, or any single-solenoid-actuator which draws less than 1.5 amps. The DI Driver System provides a software mechanism to combine adjacent channels to double the current capacity. Refer to the [PFI & LS Driver Setup window](#) for information about locking LS channels together for synchronized operation.

Each LS channel is independently controlled via pulse-width modulation (PWM). PWM duty cycle from 0 to 100% is possible. Each PWM controller utilizes a 20-bit timer operating at 2 MHz. This provides a resolution of 500 nsec and a minimum PWM frequency of 2 Hz. Since 0% and 100% duty cycles are possible, relays and actuators may be controlled in continuous on or off states.

Wiring diagram for up to four relays or proportional solenoid valves to the LS channels of the PFI Driver module: (NI recommends using 18 AWG wire (or larger) for connected devices.)

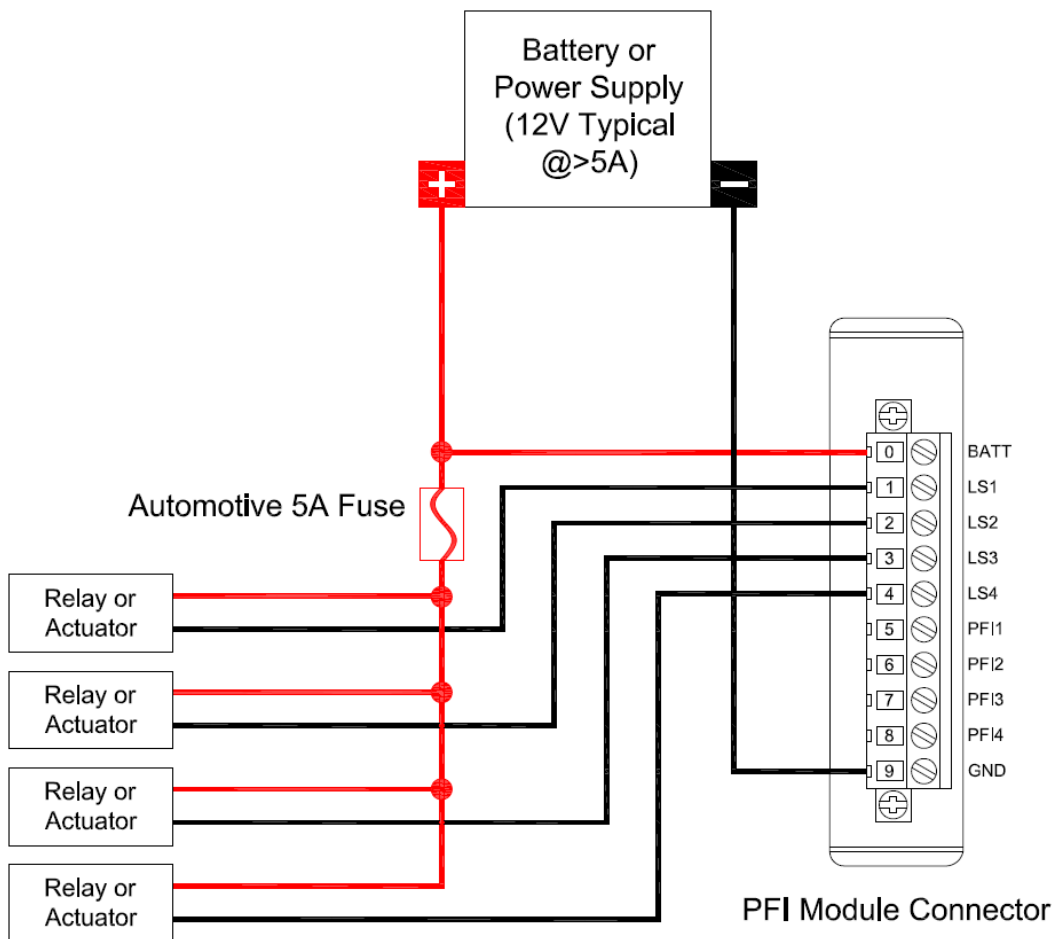

Figure 3.3.3.3.a, Connecting general purpose solenoids to the low-side driver channels

3.3.3.4 Digital Signals to NI 9411 Digital Input Module

Each NI 9411 digital input module has six digital inputs. Each DI Driver System, regardless of number of DI Driver channels, contains at least one NI 9411 module in slot one (1). EDIDS-2409 and EDIDS-2412 systems contain an additional NI 9411 module in slot four (4).

NI 9411 Module Breakout Harness

Each digital input signal pair has a different wire color and is labeled with the associated [digital input channel](#) and signal polarity. In addition to the signal wire pairs there are 5V output wires (red and red/black) and COM wire (black). The 5V regulated output is only active if the Vsup and COM screw terminal block is externally powered. Wire gauge is 22 AWG.

Pin Description	Pin #	Wire Color
DI0a	1	Orange
DI0b*	9	Orange/Black
DI1a	2	Green
DI1b*	10	Green/Black
DI2a	3	Blue
DI2b*	11	Blue/Black
Supply (+5 V Out)	4	Red
Supply (+5 V Out)	5	Red/Black
DI3a	6	White
DI3b*	13	White/Black
DI4a	7	Green/White
DI4b*	14	Blue/White
DI5a	8	Black/White
DI5b*	15	Red/White
Common (COM)	12	Black

Table 3.3.3.4.a, NI 9411 Module Breakout Harness Wire Color

*The “b” pins of the NI 9411 should not be connected for single-ended digital signals. The “b” pins should be used for optical encoders with differential or complementary outputs. Please refer to the NI 9411 Operating Instructions and Specifications for details.

List of the connector parts used to assemble the NI 9411 module pigtail:

Description	Mfr.'s Part #
AMP HDP-20 Series 109 15P Receptacle Housing	205163-1
AMP HDP-20 Series 109 Crimp Socket Contact	205090-1
Norcomp D-Sub Connector Hood, 15P 45 Degree	971-015-020R121
Paladin Tools Crimper, 26-20 AWG	PA-1460

Table 3.3.3.4.b, NI 9411 Module Breakout Harness Part List

Direct Mode and TMP Mode Commands

When operating DI Driver modules and/or the PFI Driver module in Direct mode or Triggered Multi-Pulse (TMP) mode, any of the NI 9411 digital input channels (up to 12) can be assigned to command any of the DI Driver and PFI Driver channels via the [Digital Input Setup Window](#).

Engine Position Tracking Signals

When operating DI Driver modules and/or the PFI Driver module in Engine Position Tracking (EPT) mode, the NI 9411 digital inputs are not needed to command driver channels directly because they are commanded by angle-based setpoints by the software EPT function. However, NI 9411 digital inputs are required for receiving crank and cam or encoder position signals. Any of the NI 9411 digital input channels can be assigned to crank, cam, and encoder position inputs to the EPT function via the [Digital Input Setup Window](#). Refer to the [Engine Position Tracking Setup Window](#) for more information about crank, cam, and encoder sensor signal types, and their compatibility with the NI 9411 module. Refer to the NI [9411 Operating Instructions and Specifications](#) for detailed information about digital input specifications.

The 15-pin D-Sub COM pin-12 of each NI 9411 module should be connected to the external commanding system ground, otherwise the correct logic level of the signal will not be sensed by the NI 9411 module. For single-ended digital commands, the 15-pin D-Sub “a” pins of the NI 9411 digital input channels must be connected to the signal, while leaving the “b” pins disconnected, or floating. For differential, or complimentary digital commands, the positive and negative signal pair should connect to the “a” and “b” pins, respectively.

It is good practice to use external 1K pull-down or pull-up resistors on each digital input command line in case the commands are unintentionally disconnected. For an active-high command, the digital input should be pulled low, such that the pulldown resistor is connected between the digital input and ground. For an active-low command, the digital input should be pulled high, such that the pull-up resistor is connected between the digital input and 5V, or the main power source. If 5V is used, then the 5V output pins (4, 5) of the NI 9411 module may be used for this purpose, and the Vsup and COM screw terminals must be powered.

Using External ECU Port Fuel Injector or Ignition Driver Outputs

When using another engine control system to command the DI Driver System, it is likely that the port fuel injector or ignition driver outputs of the engine controller will be used. Typically, port fuel injector or ignition driver outputs are lowside driver circuits. This means that one side of the port fuel injector solenoid or ignition coil primary is connected to battery while the other side (lowside) is connected to the engine controller and programmatically switched to ground during fuel injection pulses or ignition dwell, respectively. In order to utilize these lowside driver outputs to command the DI Driver System, a pull-up resistor must be connected between a constant voltage source (such as 5V or battery) and the digital input “a” pin of the NI 9411 module (as described above). Then, the port fuel injector or ignition output pin of the engine controller must be connected to the “a” pin of the digital input channel to be commanded. The pull-up resistors act as a low-current load to the fuel injector or ignition outputs of the engine controller.

This physical arrangement provides for an active-low injection command because the engine controller’s lowside drivers will pull the digital inputs of the NI 9411 module low when injection events are desired. This configuration

requires the Invert button of the associated digital input channel be set to Active Low via the [Digital Input Setup window](#).

Using ECU PFI or ignition driver outputs to command DI Driver System injection events requires that the DI Driver module or PFI Driver module be configured for Direct mode or TMP mode **via the [DI Driver Setup window](#) or the [PFI and LS Driver Setup window](#)**.

Since most engine controllers have diagnostic features to detect fault conditions with the fuel injector or ignition loads, and pull-up resistors are not inductive loads, the engine controller may report open-circuit faults. Such faults should be ignored. If the engine controller refuses to operate the channels due to such faults, then another command method must be arranged. Figure 3.3.3.4.c illustrates this configuration.

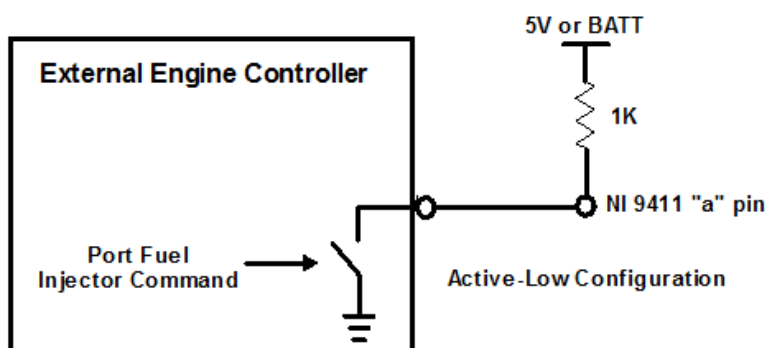

Figure 3.3.3.4.c, Connecting an Engine Controller Port Fuel Injector Output to the DI Driver System

Using External ECU Direct Injector Driver Outputs

When using another direct-injected engine control unit (ECU) to command the DI Driver System, it is sometimes possible to use the ECU direct injector driver outputs. However, it is likely that an ECU direct injector driver output will not tolerate resistive loads and internal faults will be generated which will shut down the ECU channel. Typically, ECU direct injector driver outputs will have a positive and negative terminal for each injector. The negative terminal is a lowside switch to ground and can be connected similarly to Figure 3.3.3.4.c. If the engine controller refuses to operate the channels due to diagnostic faults, then another command method must be arranged.

Using Transistor-Transistor Logic (TTL) Commands

If general purpose Transistor-Transistor Logic (TTL) commands are used from an external controller, then the TTL commands may be directly connected to the "a" pins of the NI 9411 module. The commanding device ground must be connected to the NI 9411 module COM pin. The NI 9411 "b" pins may be left disconnected.

3.3.3.5 Analog Signals to NI 9220 Analog Input Module

The DI Driver System supports an optional NI 9220 16-channel analog input module. The analog inputs are sampled at an interval of 15 milliseconds. The analog inputs are filtered and converted to engineering units via the [Analog Input Setup Window](#). The engineering values can be used as inputs to a variety of functions throughout the DI Driver System, such as lookup tables and rail pressure control.

The analog input channels are capable of directly measuring differential +/- 10V signals. Therefore, each channel has a positive and negative screw terminal connection. A COM terminal is provided as a common mode reference for all sixteen (16) channels. Refer to the [NI 9220](#) Operating Instructions and Specifications for detailed connection diagrams and specifications.

3.3.4 DI Driver System Component User Manual Reference

[SCM User Manual](#)

[NI 9082 User Manual](#)

[NI 9411 User Manual](#)

[NI 9751 \(DI Driver\) User Manual](#)

[NI 9220 User Manual](#)

[NI 9862 \(CAN\) User Manual](#)

[NI 9754 \(ESTTL\) User Manual](#)

[NI 9757 \(O2\) User Manual](#)

[NI 9758 \(PFI Driver\) User Manual](#)

[NI 9759 \(Throttle Driver\) User Manual](#)

[NI 9760 \(VR/Hall\) User Manual](#)

[PS-17 Power Supply User Manual](#)

[QS10.121 Power Supply User Manual](#)

3.3.5 Optional Enclosure System

National Instruments offers an option enclosure system for the Expandable DI Driver System which is a 19 inch rack of 7 rack units height. The NI Powertrain Controls Group will integrate a customer's EDIDS bundle into the enclosure system. The enclosure system includes the following:

- 1.) Programmable power supplies for all power electronics
 - a.) Optional single programmable power supply for all power electronics (30V, 50A)
 - b.) Optional dual half-rack programmable power supplies (30V, 25A and 150V, 5A or 300V, 2.5A)
- 2.) 12V, 15A power supply for controller power and O2 sensor power
- 3.) 5V, 1A power supply for sensor power
- 4.) Fusing
- 5.) A/C power entry and power strip
- 6.) Local ESTOP and remote ESTOP control
- 7.) Engineered internal power distribution
- 8.) cRIO-9082 auxiliary communications breakout for Ethernet, USB and RS232
- 9.) Circular Plastic Connectors on front panels with all modules slots pre-wired

Contact the [NI Powertrain Controls Group](#) or your local sales representative for purchasing information.



3.3.5.a Front View of Optional Enclosure



3.3.5.b Side View of Optional Enclosure



3.3.5.c *Top view of Optional Enclosure*

3.4 Using DI Driver System to Control Fuel Pressure

The DI Driver System supports a common rail pressure control feature with optional NI 9758 PFI Driver (available with [Optional NI 9155 Expansion Chassis](#)) and NI 9220 analog input modules. A typical common rail high pressure fuel system consists of a high pressure, cam-driven pump, connected to a fuel rail which supplies fuel to each injector. The high pressure pump has an Inlet Metering Valve (IMV) which is a solenoid proportional valve that meters the fuel to the inlet of the pump. The IMV is controlled with a lowside driver channel via PWM operation. The fuel rail has a pressure sensor connected to the end, providing analog pressure feedback to the NI 9220 analog input module for rail pressure PID control. The rail pressure PID control function generates a PWM duty cycle to maintain a specified rail pressure setpoint.

Some common rail fuel systems will have a High Pressure Valve (HPV) on the rail as a bleed valve to provide fuel flow through the system for stable pressure control. The HPV is also a proportional solenoid valve controlled with a lowside driver channel via PWM operation.

Refer to the [Rail Pressure Control Setup window](#) for details about configuring the rail pressure control function.

Typical IMV and HPV solenoids require up to 3A continuous current operation. Therefore it is important to utilize the LS channel locking feature which locks LS1 with LS2 and locks LS3 with LS4 via the [PFI and LS Driver Setup window](#). The locked channel pairs can be used to operate the IMV and HPV with up to 3A continuous current. Figure 3.4.a shows an example wiring diagram for wiring an IMV to a locked LS1 and LS2 pair, and wiring a HPV to a locked LS3 and LS4 pair.

Any of the NI 9220 analog inputs can be assigned to the rail pressure control feedback via the [Rail Pressure Control Setup window](#).

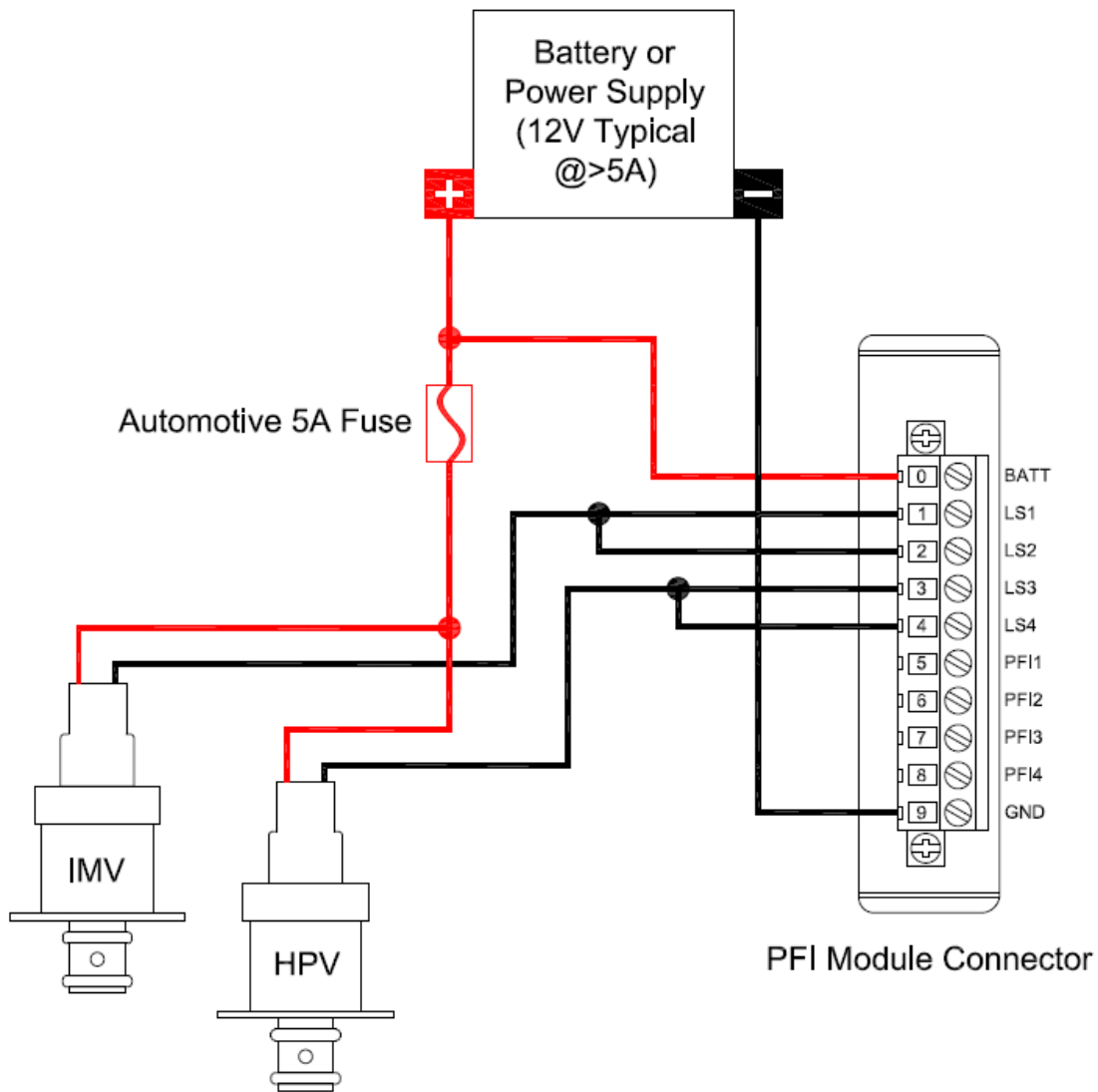

Figure 3.4.a, Diagram of Typical Wiring of an Inlet Metering Valve (IMV) and a High Pressure Valve (HPV) to a PFI Driver Module

3.5 Optimizing the DI Driver System

When connecting multiple injectors to a DI Driver System, there are a few optimizations to consider.

Simultaneous or Overlapping Injection Events

A DI Driver module uses multiplexed circuitry to provide up to three driver channels within the module for solenoid direct injectors and two channels per module for piezoelectric direct injectors. Therefore, only one channel within the module may be operated at a time. If injection events within a DI Driver System must be operated simultaneously, the simultaneous events must be connected to channels on separate DI Driver modules.

Channel Sequencing

When operating multiple sequential direct injectors, the operating sequence of channels should be planned so that the time between injections events within a single module is maximized. For example, as shown in Table 3.5.a, an 8-cylinder 4-stroke engine will have injection events separated by 90 degrees. If a 12-Channel DI Driver system is used, sequential injectors should be staged from one DI Driver module to the next. By doing this, channels within a single module will have a spacing of 360 degrees, providing maximized time for boost power supply charging and multiple injection events per cylinder.

8-Cylinder, 4 Stroke Engine With 12-Ch DI Driver System			
Injection Event	CAD	DI Driver Module	Channel
1	0	1	1
2	90	2	1
3	180	3	1
4	270	4	1
5	360	1	2
6	450	2	2
7	540	3	2
8	630	4	2

Table 3.5.a, Optimization of 8-Cylinder, 4 Stroke Engine With A 12-Ch DI Driver System

Injection Command Duration Limitation

The maximum allowed injection pulse command is internally limited to 5 milliseconds. If an external or internal command is generated which exceeds 5 milliseconds, the actual injection pulse will be halted at 5 milliseconds. If multiple external direct commands are active simultaneously on a single DI Driver module, then all three driver channels of the module will be made inactive until only one channel is commanded.

4. NI Direct Injector Driver System Interface

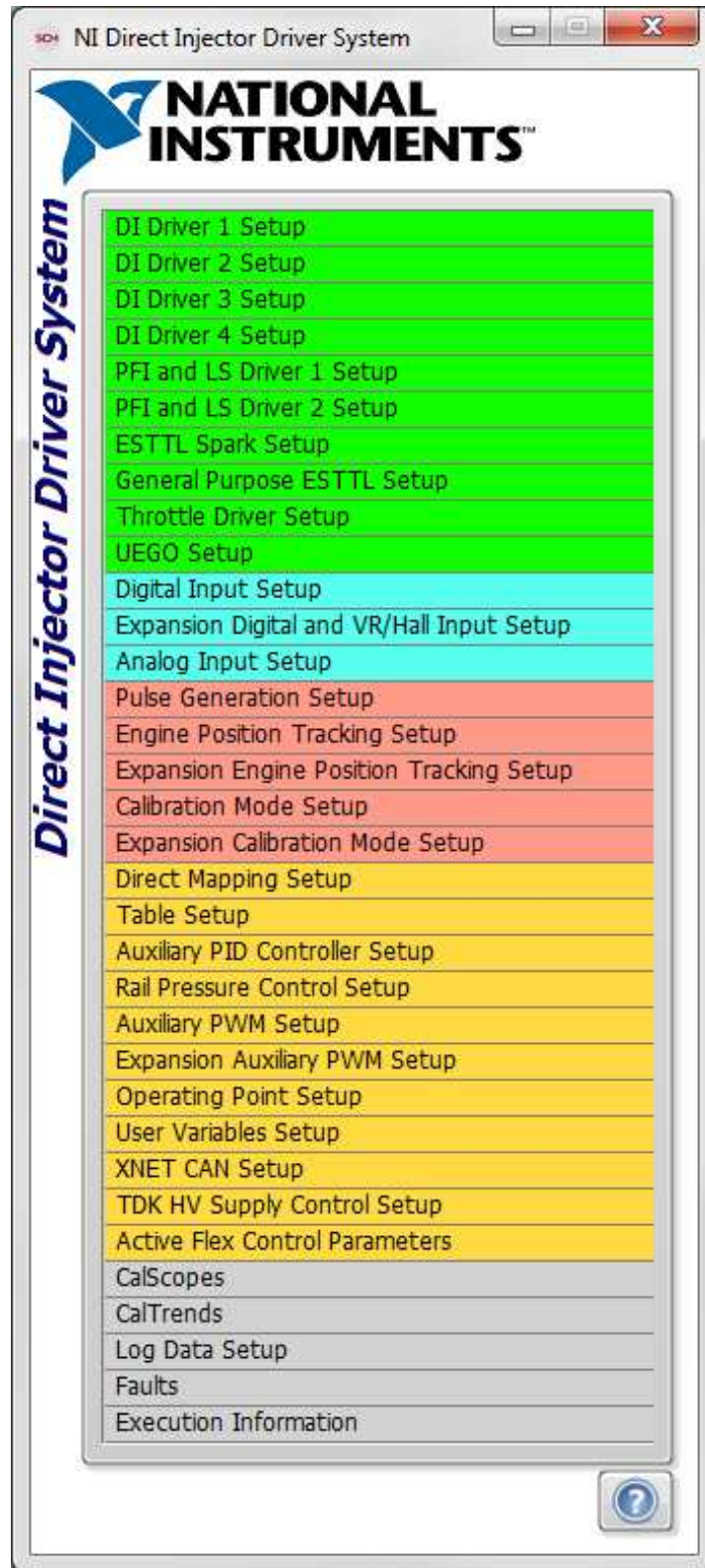

The main user interface window contains a list of all setup windows used to configure the various DI Driver System functions. Double-clicking on a setup window name will open the window and make the listed name bold. Multiple setup windows may be open simultaneously. Pressing the **X** in the upper right corner of each window will close the window. Also, double clicking the bolded window name within the main window list will close the window. A single click of a bolded window name will bring the selected window to the top with focus. Pressing the **X** in the upper right corner of the main user interface window, or pressing the **red square button** in the SCM console (3rd from left) will close all open setup windows and stop user interface communications with the DI Driver System. However, the system will still continue to operate according to the most recent user interface settings. The user interface can be started again by pressing the green run button within the SCM console.



SCM console buttons while DI Driver System user interface is closed

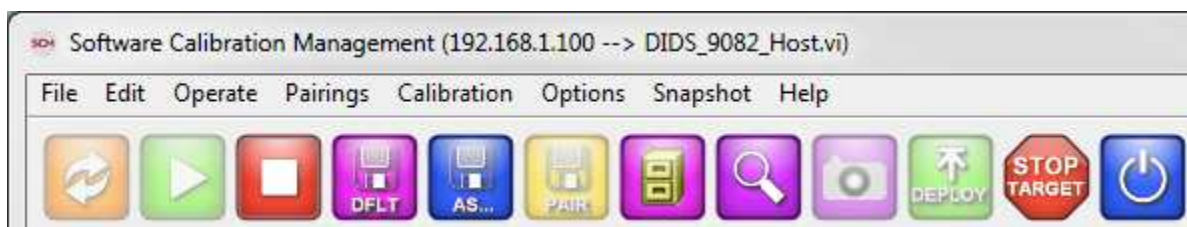

SCM console buttons while DI Driver System user interface is open

The DI Driver System can operate automatically, when powered up, according to settings saved to a system calibration file. The calibration file can be saved while the user interface is open by pressing the **purple default calibration save button** from the SCM console (4th from left). The default save function will save all current settings within the setup windows to the default calibration file. The default calibration file is located on the DI Driver System controller at "C:\system\ni-rt\LabVIEW Data\DefaultCal.cdl". The file system of the DI Driver System controller can be browsed using an FTP client. A recommended FTP client is [FileZilla](#). It is not recommended to use the FTP connection within the Windows file Explorer.

4.1 DI Driver Setup Window

The purpose of the DI Driver Setup window is to configure the Direct Injector (DI) Driver Module to the desired settings. A DI Driver System can have up to four DI Driver modules, DI1 through DI4. There is a [DIX_Config](#) window corresponding to each DI Driver module. Each DI Driver module can be configured with independent boost voltage, current profile and operating modes. For more information on DI Driver Module slot assignment, see the [hardware setup section](#).

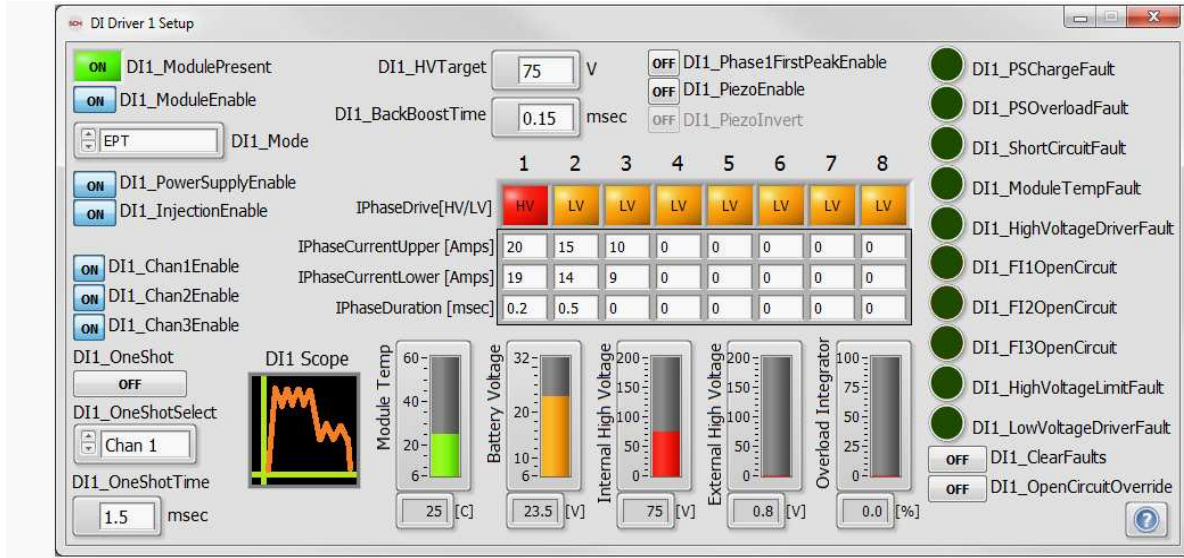

1 DIX_ModulePresent



Tip Strip: Indicates DI Driver module present and externally powered

Detail: Indicates the presence and recognition of the associated DI Driver module. The module will only be recognized when [DIX_ModuleEnable](#) is **ON**, a DI Driver module is inserted in the [assigned slot](#), and the module is properly [externally powered](#).

2 DIX_ModuleEnable

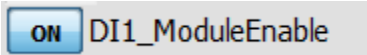

Tip Strip: Enables DI Driver module operation

Detail: If a DI driver module is inserted in the [assigned slot](#), [externally powered](#), and [DIX_ModuleEnable](#) is **ON**, then the controller begins communicating with the module and allows the module to operate.

3 DIX_Mode

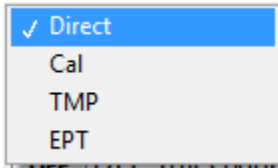

Tip Strip: Selects operating mode for DI Driver module

Detail: Operating mode applied to the associated DI Driver module.

Each DI Driver module can be independently assigned a mode of operation which will apply to all channels of the associated DI Driver module. The [DIX_Mode](#) refers to the mode of sending injection commands to the channels of the associated module. It is still necessary to configure the current and voltage drive profile via this [DIX_Driver Setup](#) window.

Direct Mode: The DI Driver module channels are commanded directly by external digital inputs of the NI 9411 modules. The digital input which commands each channel can be configured via the [Digital Input Setup](#) window. The digital input level which commands the DI Driver channel **ON** is configured via the **Invert** buttons of the [Digital Input Setup](#) window. The duration of the injection command is determined by the direct duration of the digital input. The maximum duration allowed is 5 msec. If longer durations are required, consult with your National Instruments sales engineer or support team.

Calibration Mode: Calibration mode is for the purpose doing injector flow calibrations. Calibration mode is configured via the [Calibration Mode Setup](#) window for a specified number of injection events, command duration and command period. Only one channel of each module may be enabled for **Calibration mode**. If more than one channel is enabled, then commands will not be delivered.

Triggered Multi-Pulse (TMP) Mode: The DI Driver module channels are commanded by a specified sequence of pulses and triggered by an external digital rising or falling edge to the assigned digital input channel. The pulse sequence is configured via the [DI-TMP](#) tab of the [Pulse Generation Setup](#) window. The external trigger channel is assigned via the [Digital Input Setup](#) window.

Engine Position Tracking (EPT) Mode: The DI Driver module channels are commanded by a specified sequence of pulses and triggered by crankshaft angle events for each pulse, with respect to an assigned Top Dead Center (TDC) reference value. The pulse sequence is configured via the [DI-EPT](#) tab of the [Pulse Generation Setup](#) window. The TDC reference value is configured via the [TDC Channel Mapping](#) tab of the [Engine Position Tracking Setup](#) window. Engine position tracking parameters are configured via the [EPT](#) tab of the [Engine Position Tracking Setup](#) window for a variety of crank and cam signal patterns.

4 DIX_PowerSupplyEnable

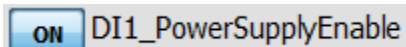

Tip Strip: Enables internal boost power supply [DI Driver Setup](#) window

Detail: When **ON**, the module internal boost power supply is enabled and will maintain the working voltage specified by [DIX_HVTarget](#). When **OFF**, the module internal boost power supply is disabled. The actual boost voltage is displayed in the [Internal High Voltage](#) indicator within this window. For more information on the module internal boost power supply, please see [Powering the System](#).

5 DIX_InjectionEnable

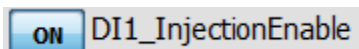

Tip Strip: Enables all channels of module

Detail: When **ON**, the module injection control circuitry is enabled. When **OFF**, the module injection control circuitry is disabled. This parameter does not generate any injection pulses, but only enables the driver circuitry to operate when fuel commands are generated.

6 DIX_ChanXEnable

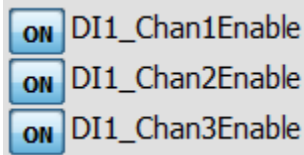

Tip Strip: Enables channel regardless of mode

Detail: When **ON**, the associated channel is enabled to operate.

7 DIX_OneShot

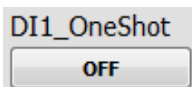

Tip Strip: Generates one-shot command to selected channel

Detail: When pressed, the DI Driver module will deliver a one-shot pulse to the channel selected in [DIX_OneShotSelect](#), having a duration specified by [DIX_OneShotTime](#). This button returns to the **OFF** state automatically.

8 DIX_OneShotSelect

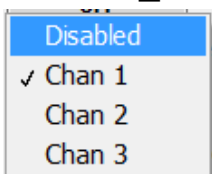

Tip Strip: Selects channel for one-shot command

Detail: Selects the DI Driver channel to which a one-shot pulse is delivered. To disable one-shot functionality, set to **Disabled**.

9 DIX_OneShotTime

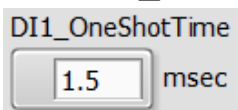

Tip Strip: Duration of one-shot command

Units: msec

Detail: Duration of one-shot pulses in msec.

10 DIX_HVTarget

DI1_HVTarget V

Tip Strip: DI Driver high voltage setpoint for internal boost supply

Units: V

Detail: The working voltage set point of the internal boost power supply.

11 DIX_BackBoostTime

DI1_BackBoostTime msec

Tip Strip: Time period during which injector solenoid energy is directed back to the module boost power supply (after end of pulse)

Units: msec

Detail: The time period at the end of the injection pulse for which the back-electromotive force (EMF) of the injector solenoid is directed to the internal boost power supply.

IPhaseArray

When operating solenoid injectors, the [IPhaseArray](#) defines up to eight sequential current-drive phases within each injection command. Each phase is implemented sequentially and can specify [upper](#) and [lower](#) current dithering setpoints, [phase duration](#), and [drive circuit – high voltage or battery voltage](#). The high voltage drive circuit should only be used as little as necessary so that the internal boost power supply energy is conserved and not overloaded. Please refer to the [DI Driver Rev F](#) manual for various [IPhaseArray](#) configurations and the resulting current profile of the Solenoid injector. The [IPhaseArray](#) consists of the following parameters:

12 IPhaseDrive

IPhaseDrive[HV/LV]

1	2	3	4	5	6	7	8
HV	LV	LV	LV	LV	LV	LV	LV

Tip Strip: Selects low voltage or high voltage for the associated phase

Detail: When operating solenoid injectors, selecting these buttons will toggle the voltage drive source of the associated phase between **high voltage (HV)** and **battery voltage (LV)**.

[IPhaseArray](#) is used differently in piezo mode by enabling [DIX_PiezoEnable](#). The eight elements of the [IPhaseArray](#) are divided into two groups. The first four elements are used for charging the piezo load at the beginning of injection, and the last four elements are used for discharging the piezo load at the end of injection. The ability to select HV or LV for each phase is not available for piezo injector operation because the high voltage driver circuit is always used (as shown below).

IPhaseDrive[HV/LV]

1	2	3	4	5	6	7	8
Up	Up	Up	Up	Down	Down	Down	Down

13 IPhaseCurrentUpper

IPhaseCurrentUpper [Amps]	20	15	10	0	0	0	0	0
---------------------------	----	----	----	---	---	---	---	---

Tip Strip: Upper current dithering setpoint

Units: Amps

Detail: Upper threshold for current dithering set-point in Amps.

14 IPhaseCurrentLower

IPhaseCurrentLower [Amps]	19	14	9	0	0	0	0	0
---------------------------	----	----	---	---	---	---	---	---

Tip Strip: Lower current dithering setpoint

Units: Amps

Detail: Lower threshold for current dithering set-point in Amps.

15 IPhaseDuration

IPhaseDuration [msec]	0.2	0.5	0	0	0	0	0	0
-----------------------	-----	-----	---	---	---	---	---	---

Tip Strip: Duration of phase. 0 = hold to end of command.

Units: msec

Detail: Duration in milliseconds of each phase. When the duration is reached, operation proceeds to the next phase. A special duration value of zero means that operation will remain in that phase until the end of the injection command.

A typical IPhase array configuration for operating piezo direct injectors is shown below.

	1	2	3	4	5	6	7	8
IPhaseDrive[HV/LV]	Up	Up	Up	Up	Down	Down	Down	Down
IPhaseCurrentUpper [Amps]	8	8	8	8	8	8	8	8
IPhaseCurrentLower [Amps]	7	7	7	7	7	7	7	7
IPhaseDuration [msec]	0.025	0.025	0.025	0	0.025	0.025	0.025	0

16 DIX_Phase1FirstPeakEnable

<input type="checkbox"/> DI1_Phase1FirstPeakEnable
--

Tip Strip: Causes phase 2 to begin after current reaches first peak

Detail: Phase1FirstPeakEnable is a software option of the DI Driver module to transfer operation from the first phase to the second phase upon reaching the first current peak corresponding to the first phase [IPhaseCurrentUpper](#). The first [IPhaseDuration](#) should be set to a minimum value long enough for the first peak to be reached.

	1	2	3	4	5	6	7	8
IPhaseDrive[HV/LV]	HV	LV	LV	LV	LV	LV	LV	LV
IPhaseCurrentUpper [Amps]	20	15	10	0	0	0	0	0
IPhaseCurrentLower [Amps]	19	14	9	0	0	0	0	0
IPhaseDuration [msec]	0.2	0.5	0	0	0	0	0	0

17 DIX_PiezoEnable

DI1_Phase1FirstPeakEnable
 DI1_PiezoEnable

Tip Strip: Enables piezo operating mode

Detail: When **ON**, enables piezo injector operation. [DIX_BackBoostTime](#) will not be used and the control will be disabled. [IPhaseArray](#) is used differently in piezo mode.

18 DIX_PiezoInvert

DI1_PiezoInvert

Tip Strip: Enables inverted piezo operating mode

Detail: When **ON**, enables inverted Piezo operation. In contrast to normal piezo mode, the first four [IPhaseArray](#) elements are used for discharge and the last four elements are used for charge, as shown below. When operating in inverted piezo mode, in addition to adding inductor and shorting of channel 3, channel 2 must be disconnected. Therefore, a DI Driver module can only drive one inverted piezo injector. Please refer to the [DI Driver Rev F](#) manual for details on inverted piezo operation.

	1	2	3	4	5	6	7	8
IPhaseDrive[HV/LV]	Down	Down	Down	Down	Up	Up	Up	Up

19 DIX_Scope

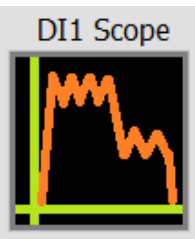

Tip Strip: DI Scope current and voltage trace

Detail: When icon is pressed, it will display a dialog with a graph showing current, in Amps, during the most recent injection command to the associated DI Driver module. If multiple channels within the module are operating, it is not possible to identify which channel is being displayed. Note that the resolution of the current display is approximately 10 μ sec sampling interval, and is for reference only. A box instrument oscilloscope and current probe may be necessary for more detailed information. The [voltage trace](#) shown is not recorded within injection commands. Therefore, the [voltage trace](#) will be constant with the last value recorded before the injection command. Also, the [current trace](#) is not recorded outside of the injection command and will be displayed as zero.

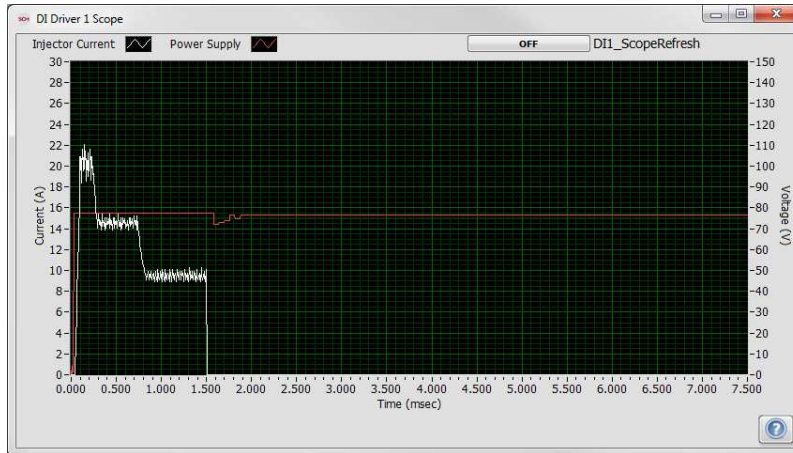

When [DIX_ScopeRefresh](#) is pressed, the graph will refresh with injector current, in Amps, during the most recent injection command to the associated DI Driver module. If multiple channels within the module are operating, it is not possible to identify which channel is being displayed. Note that the resolution of the current display is approximately 10 μ sec sampling interval, and is for reference only. A box instrument oscilloscope and current probe may be necessary for more detailed information. The voltage trace shown is not recorded within injection commands. Therefore, the voltage trace will be constant with the last value recorded before the injection command. Also, the current trace is not recorded outside of the injection command and will be displayed as zero.

20 Module Temp

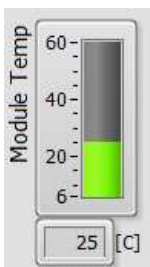

Tip Strip: Internal module temperature

Units: C

Detail: Indicates the internal DI Driver module temperature. The shutdown fault threshold is 80 C. If the internal module temperature reaches 80 C, a [DIX_ModuleTempFault](#) will be indicated and the internal boost power supply and injector drive channels will be disabled until the fault is cleared.

21 Battery Voltage



Tip Strip: DI Driver battery voltage level

Units: V

Detail: Indicates the external battery voltage supply level to DI Driver module terminals 0 (BATT) and 9 (GND). This should be in the range of 9-32V. While the internal boost supply will function from the 9-32V battery voltage, it will operate more efficiently and cooler if the battery voltage is in the range of 24V, as opposed to 12V. The performance and power dissipation of the module and internal boost power supply are dependent on the injector load and rate of injection events.

22 Internal High Voltage

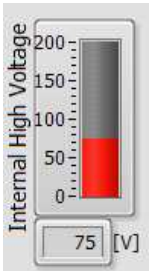

Tip Strip: Internal boost supply high voltage level

Units: V

Detail: Indicates the actual internal boost power supply voltage.

23 External High Voltage

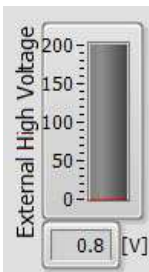

Tip Strip: High voltage level supplied externally to terminal 7 of DI Driver to override internal boost supply

Units: V

Detail: Indicates the external high voltage supply level. If the external high voltage supply pin (7 EXT PWR) is connected to a level greater than 24V, then the internal boost power supply will automatically shut down and rely on external power. Using an external high voltage supply is occasionally necessary, depending on injector operating requirements. Contact your National Instruments sales engineer or support team to determine if your application requires an external high voltage supply.

24 OverLoad Integrator



Tip Strip: Indicates level of internal boost power supply load

Units: %

Detail: The DI driver module maintains an integrator of power supply usage. An internal counter increments with each internal power supply voltage boost and decrements according to a fixed time interval. If the integrator winds up to 100 percent, then an overload fault will be set. This is an indication that the module temperature would soon rise beyond its maximum operating temperature if not stopped. The [module temperature fault](#) may be tripped before the overload fault, depending on the actual conditions.

25 DIX_PSChargeFault

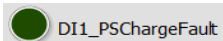

Tip Strip: DI Driver internal boost power supply charging fault

Detail: Indicates that the internal boost power supply is not able to increase the voltage within 255 boost pulses. This is a critical fault and will shut down the internal boost power supply and all injector channels.

26 DIX_PSOverloadFault

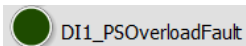

Tip Strip: Internal boost power supply charging fault

Detail: Indicates that the internal boost power supply is overloaded and cannot keep up with the demand, otherwise it will overheat. This is a critical fault and will shut down the internal boost power supply and all injector channels.

27 DIX_ShortCircuitFault

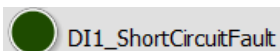

Tip Strip: Injector short-circuit fault

Detail: Indicates that the current to one of the DI Driver module channels exceeded 40A and is likely experiencing a short circuit condition. This is a critical fault and will shut down the internal boost power supply and all injector channels.

28 DIX_ModuleTempFault

DI1_ModuleTempFault

Tip Strip: Module over-temperature fault (80C)

Detail: Indicates that the internal DI Driver module temperature has exceeded 80 C. This is a critical fault and will shut down the internal boost power supply and all injector channels.

29 DIX_HighVoltageDriverFault

DI1_HighVoltageDriverFault

Tip Strip: High voltage driver circuit fault

Detail: Indicates that the high-voltage, high-side FET is overloaded. This fault is often caused by a short circuit condition during high-voltage drive phases. This is a critical fault and will shut down the internal boost power supply and all injector channels.

30 DIX_FIXOpenCircuit

DI1_FI1OpenCircuit

DI1_FI2OpenCircuit

DI1_FI3OpenCircuit

Tip Strip: Injector open-circuit fault

Detail: Indicates that the associated DI Driver channel cannot drive current above 1.5A at any point within the injection command. This is a non-critical fault and cannot be cleared. This fault does not interfere with injector channel operation. The fault will be automatically cleared upon the next injection command during which 1.5A is reached.

31 DIX_HighVoltageLimitFault

DI1_HighVoltageLimitFault

Tip Strip: Internal boost power supply over-voltage fault

Detail: Indicates that the high-voltage supply has exceeded 195V. This can occur if the high-voltage supply is not used at all during injection events, while energy is recovered from the injector to the internal boost supply during [BackBoostTime](#). This can also occur if an external high-voltage supply is used and is configured for outputting more than 195V. Such a condition is strongly discouraged because the components of the DI Driver module are only rated for 200V. This is a critical fault and will shut down the internal boost power supply and all injector channels.

32 DIX_LowVoltageDriverFault

DI1_LowVoltageDriverFault

Tip Strip: Low voltage driver circuit fault

Detail: Indicates that the low-voltage, high-side FET is overloaded. This fault is often caused by a short circuit condition during low-voltage drive phases. This is a critical fault and will shut down the internal boost power supply and all injector channels.

33 DIX_ClearFaults

OFF DI1_ClearFaults

Tip Strip: Clears any critical faults with DI Driver

Detail: When this one-shot is pressed, all critical faults of the DI Driver module will be cleared.

34 DIX_OpenCircuitOverride

OFF DI1_OpenCircuitOverride

Tip Strip: Determines whether open-circuit faults are indicated

Detail: When **ON**, the Open Circuit fault indicators will not be updated, regardless of open-circuit fault conditions.

4.1.1 DI Driver Scope Window

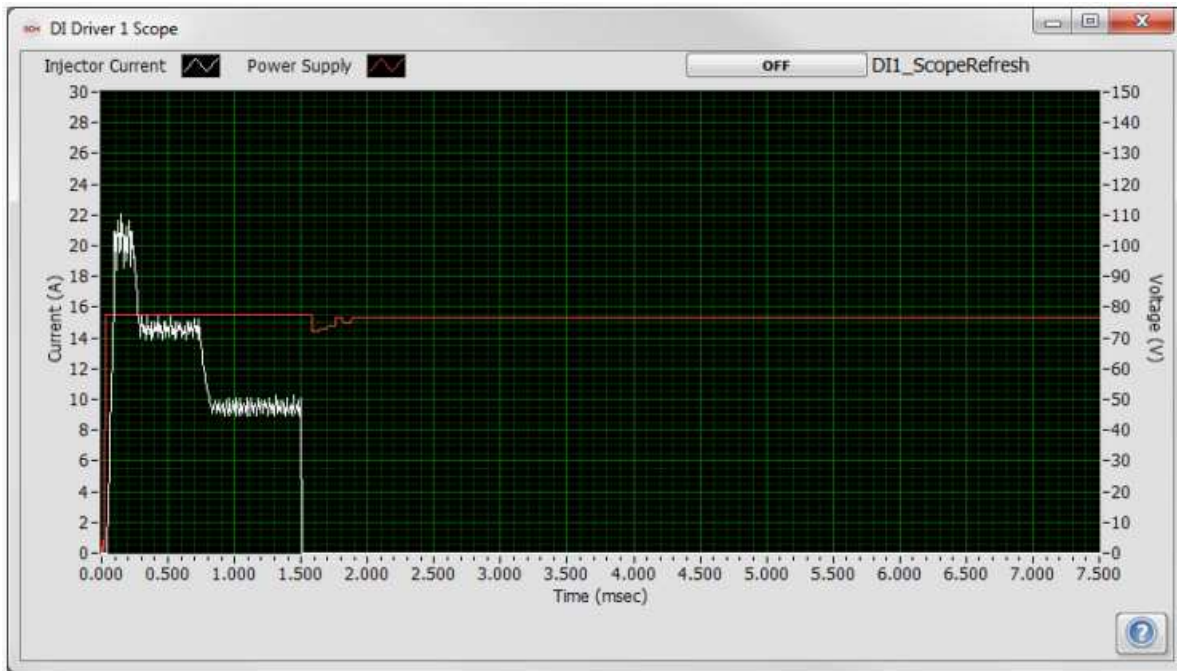

1 DIX_ScopeRefresh

Tip Strip: Refreshes DI scope data

Detail: When DIX_ScopeRefresh is pressed, the graph will refresh with injector current, in Amps, during the most recent injection command to the associated DI Driver module. If multiple channels within the module are operating, it is not possible to identify which channel is being displayed. Note that the resolution of the current display is approximately 10 μ sec sampling interval, and is for reference only. A box instrument oscilloscope and current probe may be necessary for more detailed information. The voltage trace shown is not recorded within injection commands. Therefore, the voltage trace will be constant with the last value recorded before the injection command. Also, the current trace is not recorded outside of the injection command and will be displayed as zero.

4.2 PFI and LS Driver Setup Window

The purpose of the PFI and LS Driver Setup window is to configure the operation of the PFI Driver module. Three tabs are provided for the following:

[PFI Module Control Tab](#): Enable the PFI Driver module, configure the operating mode, test PFI channels with one-shot pulses, and monitor module faults.

[PFI 1-4 Tab](#): Enable individual PFI Driver PFI channels 1-4 and configure current control parameters.

[LS 1-4 Tab](#): Enable individual PFI Driver lowside channels 1-4 and configure the Pulse Width Modulation (PWM) parameters.

The PFI Driver module is an optional module for the NI 9155 MXIe Expansion Chassis. This setup window is only applicable if the PFI Driver module is inserted in the assigned slot.

4.2.1 PFI Module Control Tab

The purpose of the PFI Module Control Tab is to enable the PFI Driver module, configure the operating mode, test PFI channels with one-shot pulses, and monitor module faults.

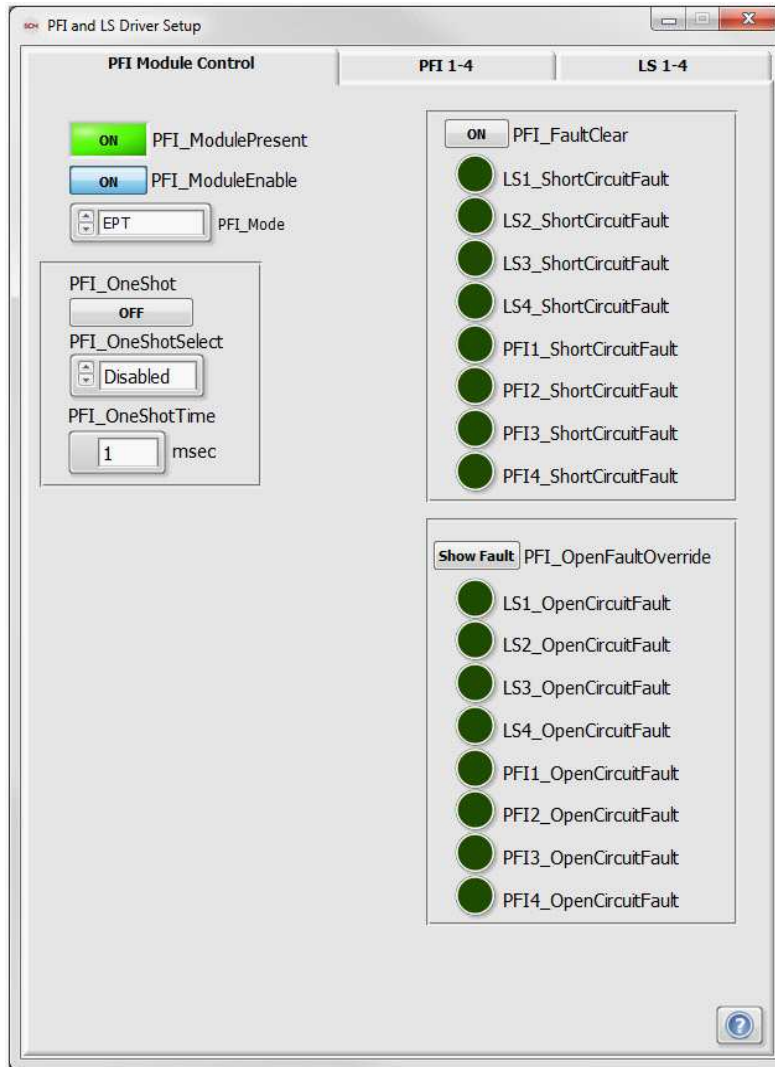

1 PFI_ModulePresent



Tip Strip: Indicates PFI Driver module present and externally powered

Detail: Indicates the presence and recognition of the PFI Driver module. The module will only be recognized when [PFI_ModuleEnable](#) is ON, a PFI Driver module is inserted in the [assigned slot](#), and the module is properly [externally powered](#).

2 PFI_ModuleEnable

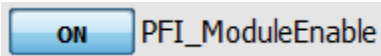

Tip Strip: Enables PFI Driver module operation

Detail: If a PFI driver module is inserted in the [assigned slot](#), [externally powered](#), and [PFI_ModuleEnable](#) is **ON**, then the controller begins communicating with the module and allows the module to operate.

3 PFI_Mode

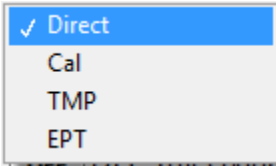

Tip Strip: Selects operating mode for PFI Driver module

Detail: Operating mode applied to the PFI Driver module.

The PFI Driver module can be assigned a mode of operation which will apply to all PFI channels. The lowside channels are not affected by this mode parameter. The [PFI_Mode](#) refers to the mode of sending injection commands to the channels of the module.

Direct Mode: The PFI Driver module PFI channels are commanded directly by external digital inputs of the NI 9411 modules. The digital input which commands each channel can be configured via the [Digital Input Setup](#) window. The digital input level which commands the PFI channel **ON** is configured via the **Invert** buttons of the [Digital Input Setup](#) window. The duration of the injection command is determined by the direct duration of the digital input.

Calibration Mode: Calibration mode is for the purpose doing injector flow calibrations. Calibration mode is configured via the [Calibration Mode Setup](#) window for a specified number of injection events, command duration and command period. Only one PFI channel of the module may be enabled for Calibration Mode. If more than one channel is enabled, then commands will not be delivered.

Triggered Multi-Pulse (TMP) Mode: The PFI Driver module PFI channels are commanded by a specified sequence of pulses and triggered by an external digital rising or falling edge to the assigned 9411 digital input channel. The pulse sequence is configured via the [PFI](#) tab of the [Pulse Generation Setup](#) window. The external trigger channel is assigned via the [Digital Input Setup](#) window.

Engine Position Tracking (EPT) Mode: The PFI Driver module PFI channels are commanded by a specified sequence of pulses and triggered by crankshaft angle events for each pulse, with respect to an assigned Top Dead Center (TDC) reference value. The pulse sequence is configured via the [PFI](#) tab of the [Pulse Generation Setup](#) window. The TDC reference value is configured via the [TDC Channel Mapping](#) tab of the [Engine Position Tracking Setup](#) window. Engine position tracking parameters are configured via the [EPT](#) tab of the [Engine Position Tracking Setup](#) window for a variety of crank and cam signal patterns.

4 PFI_OneShot

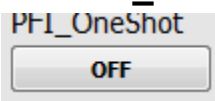

Tip Strip: Generates one-shot command to selected channel

Detail: When pressed, the PFI Driver module will deliver a one-shot pulse to the PFI channel selected in [PFI_OneShotSelect](#), having a duration specified by [PFI_OneShotTime](#). This button returns to the **OFF** state automatically.

5 PFI_OneShotSelect

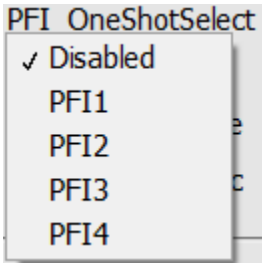

Tip Strip: Selects channel for one-shot command

Detail: [PFI_OneShotSelect](#) selects the PFI Driver channel to which a one-shot pulse is delivered. To disable one-shot functionality, set to **Disabled**.

6 PFI_OneShotTime

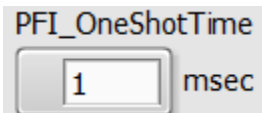

Tip Strip: Duration of one-shot command

Units:msec

Detail: Duration of one-shot pulses.

7 PFI_FaultClear

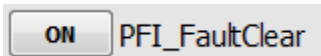

Tip Strip: Clear PFI module short-circuit faults

Detail: When this one-shot is pressed, all critical faults of the PFI Driver module will be cleared.

8 ShortCircuitFaults

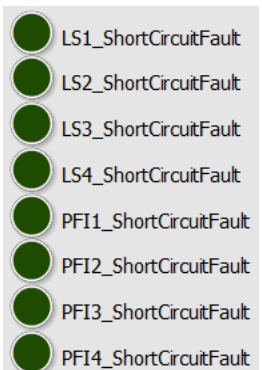

Tip Strip: Lowside channel short-circuit fault

Detail: Indicates that the current rise rate to the associated channel is indicative of a short circuit condition. This is a critical fault and will shut down the associated channel.









9 PFI_OpenFaultOverride

Show Fault PFI_OpenFaultOverride

Tip Strip: Determines whether open-circuit faults are indicated

Detail: When set to **OVERRIDE**, the open circuit faults will be ignored and will not be indicated.

10 OpenCircuitFaults

-  LS1_OpenCircuitFault
-  LS2_OpenCircuitFault
-  LS3_OpenCircuitFault
-  LS4_OpenCircuitFault
-  PFI1_OpenCircuitFault
-  PFI2_OpenCircuitFault
-  PFI3_OpenCircuitFault
-  PFI4_OpenCircuitFault

Tip Strip: Lowside channel open-circuit fault

Detail: An open circuit fault is detected when the current never reaches the requested current level specified by the lowest current setpoint in Phase 1 or Phase 2 of the PFI 1-4 tab. This is not a critical fault. If an open circuit fault is indicated, pulses will continue to be delivered to the channel as normal. The open circuit fault indicator is updated at the end of each delivered command pulse.

4.2.2 PFI 1-4 Tab

The purpose of the PFI 1-4 tab is to enable individual PFI Driver PFI channels 1-4, and configure current control parameters.



1 PFI_FirstPeak

PFI1_FirstPeak

OFF

Tip Strip: Causes phase 2 to begin after current reaches first peak

Detail: A software option of the PFI Driver module to transfer operation from the first phase to the second phase upon reaching the first current peak corresponding to the first phase current setpoint. The first phase duration should be set to a minimum value long enough for the first peak to be reached.

2 PFI Phase Setpoint & Duration

Phase 1	Phase 2	
3	1.5	Setpoint[Amps]
1.5	0	Duration[msec]

Tip Strip: Current setpoint for this phase, Duration for this phase

Units: Setpoint: Amps, Duration: msec

Detail: These parameters configure the current and duration of the two phase within each injection command. When the duration is reached, operation proceeds to the next phase. A special duration value of zero means that operation will remain in that phase until the end of the injection command. Using the values specified in the above control image, the current profile to the injector would be 4A for 1.5 msec, followed by 1A for the remainder of the injection command.

3 PFI1_ChanEnable

PFI1_ChanEnable

Tip Strip: Enables PFI channel

Detail: Enables individual PFI Channel of the PFI Driver module.

4 PFI1_RecircAlways

PFI1_RecircAlways

Tip Strip: Allows current to recirculate always while command is ON and OFF

Detail: When **ON**, the current to the load is allowed to re-circulate, or “freewheel” at all times. When **OFF**, the current to the load is allowed to re-circulate only during injection commands, while current is being controlled to the specified level. When **OFF**, the current to the load is cutoff sharply at the end of the injection command with the use of a zener diode internal to the module.

5 PFI 2 - 4

PFI 2

PFI2_FirstPeak	<input type="button" value="OFF"/>	PFI2_ChanEnable	<input type="button" value="OFF"/>		
Phase 1	3	Phase 2	1.5		Setpoint[Amps]
Phase 1	1.5	Phase 2	0		Duration[msec]
PFI2_RecircAlways					<input type="button" value="OFF"/>

PFI 3

PFI3_FirstPeak	<input type="button" value="OFF"/>	PFI3_ChanEnable	<input type="button" value="OFF"/>		
Phase 1	3	Phase 2	1.5		Setpoint[Amps]
Phase 1	1.5	Phase 2	0		Duration[msec]
PFI3_RecircAlways					<input type="button" value="OFF"/>

PFI 4

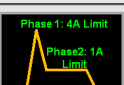
PFI4_FirstPeak	<input type="button" value="OFF"/>	PFI4_ChanEnable	<input type="button" value="OFF"/>		
Phase 1	3	Phase 2	1.5		Setpoint[Amps]
Phase 1	1.5	Phase 2	0		Duration[msec]
PFI4_RecircAlways					<input type="button" value="OFF"/>

See descriptions for PFI 1.

4.2.3 LS 1-4 Tab

The purpose of the PFI LS 1-4 tab is to enable individual PFI Driver lowside (LS) channels 1-4, and configure their Pulse Width Modulation (PWM) parameters. Each LS channel is capable of 1.5A continuous. A special mode of operation is provided to combine current drive capacity among pairs of channels. LS channels one and two can be locked together to provide up to 3A current drive capacity. Likewise, LS channels three and four can be locked together to provide 3A current drive capacity. When channels are locked together, they operate in lock-sync with each other. When channels one and two are locked together, the PWM parameters for channel one are commanded to both channels one and two. When channels three and four are locked together, the PWM parameters for channel three are commanded to channels three and four.

Channels one and three of the **Lowside channels on the first PFI Module** are also provided special modes of operation for common rail diesel fuel pressure control. It is typical that common rail diesel fuel systems have high pressure pumps with Inlet Metering Valves (IMV) which are proportional solenoid valves requiring PWM operation to control rail pressure by regulating the inlet fuel flow to the pump. Common rail diesel fuel systems may also have a High Pressure Valve (HPV) as a bleed valve on the fuel rail. These valves also require PWM operation to control the pressure bleed rate to return fuel to the tank. Channels one and three are provided with mode selectors to operate as IMV or HPV controls. It is typical that IMV and HPV solenoids require up to 3A current drive. Therefore, it is recommended that channel one be locked with channel two when operating as IMV or HPV control. Likewise, it is recommended that channel three be locked with channel four when operating as IMV or HPV control.

When channel one or channel three is configured for IMV or HPV control, then the [Rail Pressure Control Setup window](#) should be configured to implement PID control of common rail pressure using those channels.

There are no dedicated IMV or HPV control modes available on the **Lowside channels on the second PFI Module**. Only generic PWM parameters are available on **PFI2 (LS1-4) tab**. LS channels one and two and LS channels three and four can still be locked together to supply up to 3A current drive much like the **first PFI Module**.

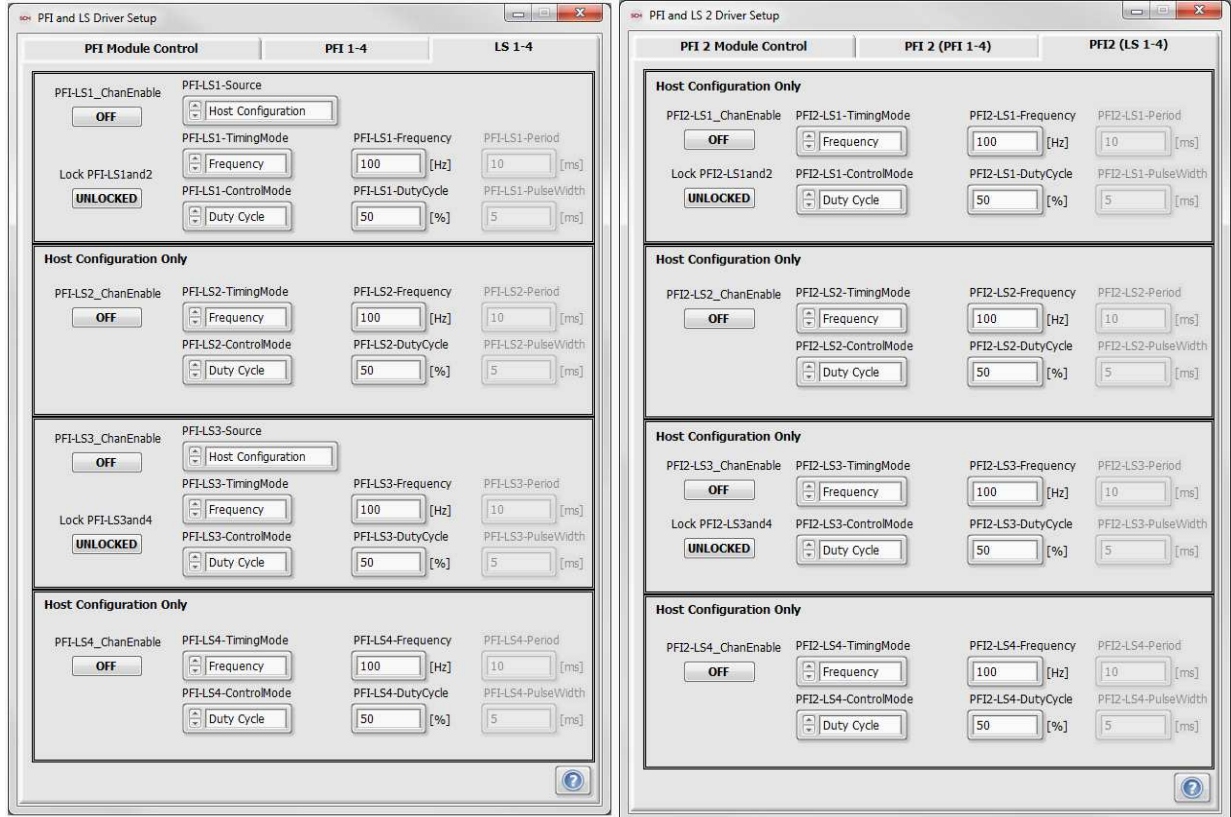

1 PFI-LSX_ChانEnable

PFI-LS1_ChانEnable

OFF

Tip Strip: Enables lowside channel

Detail: When **ON**, PFI-LSX channel is enabled for PWM operation. When PFI-LS12_Lock is **ON**, then PFI-LS2 parameters are not active because PFI-LS1 controls PFI-LS2. Likewise, when PFI-LS34_Lock is **ON**, then PFI-LS4 parameters are not active because PFI-LS3 controls PFI-LS4.

2 Lock PFI-LS1and2

Lock PFI-LS1and2

UNLOCKED

Tip Strip: Lock PFI-LS1&2 Channels. This can only be Enabled when [PFI-LS1_ChانEnable](#) and [PFI-LS2_ChانEnable](#) buttons are **OFF**

Detail: When **ON**, PFI-LS1 and PFI-LS2 channels are locked together for synchronous operation. This button is only active when both PFI-LS1 and PFI-LS2 channels are disabled. This rule ensures that LS channels one and two will be in lock sync when enabled.

3 Lock PFI-LS3and4

Lock PFI-LS3and4

UNLOCKED

Tip Strip: Lock PFI-LS3&4 Channels. This can only be Enabled when [PFI-LS3_ChانEnable](#) and [PFI-LS4_ChانEnable](#) buttons are **OFF**

Detail: When **ON**, PFI-LS3 and PFI-LS4 channels are locked together for synchronous operation. This button is only active when both PFI-LS3 and PFI-LS4 channels are disabled. This rule ensures that LS channels three and four will be in lock sync when enabled.

4 PFI-LS1-Source

PFI-LS1-Source

- ✓ Host Configuration
- Rail Pressure IMV PID
- Rail Pressure HPV PID

Tip Strip: Source of lowside PWM command

Detail: Selects the mode of operation for PFI-LS1:

Host Configuration: Allows PWM parameters to be entered directly via this tab

IMV Control: Causes PWM parameters for the associated channel to be sourced from the IMV control function configured by the [Rail Pressure Control Setup window](#).

HPV Control: Causes PWM parameters for the associated channel to be sourced from the HPV control function configured by the [Rail Pressure Control Setup window](#).

5 PFI-LS3 Source

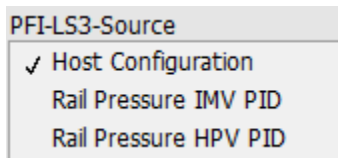

Tip Strip: Source of lowside PWM command

Detail: Selects the mode of operation for PFI-LS3:

Host Configuration: Allows PWM parameters to be entered directly via this tab

IMV Control: Causes PWM parameters for the associated channel to be sourced from the IMV control function configured by the [Rail Pressure Control Setup window](#).

HPV Control: Causes PWM parameters for the associated channel to be sourced from the HPV control function configured by the [Rail Pressure Control Setup window](#).

6 PFI-LSX-TimingMode

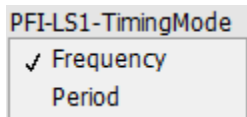

Tip Strip: Format of lowside PWM command

Detail: Selects whether to use frequency or period parameters for PWM specification.

7 PFI-LSX-ControlMode

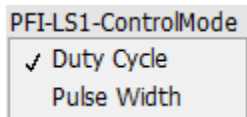

Tip Strip: Format of lowside PWM command

Detail: Selects whether to use duty cycle or pulsewidth parameters for PWM specification.

8 PFI-LSX-Frequency

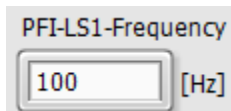

Tip Strip: Frequency of lowside PWM command

Units: Hz

Detail: Specifies the frequency of PWM operation for the associated PFI-LS channel.

9 PFI-LSX-DutyCycle

PFI-LS1-DutyCycle
 [%]

Tip Strip: Duty cycle of lowside PWM command

Units: %

Detail: Specifies the duty cycle of PWM operation for the associated PFI-LS channel.

10 PFI-LSX-Period

PFI-LS1-Period
 [ms]

Tip Strip: Period of lowside PWM command

Units: msec

Detail: Specifies the period of PWM operation for the associated PFI-LS channel.

11 PFI-LSX-PulseWidth

PFI-LS1-PulseWidth
 [ms]

Tip Strip: Pulse width of lowside PWM command

Units: msec

Detail: Specifies the pulsewidth of PWM operation for the associated PFI-LS channel.

4.3 ESTTL Spark Setup

The purpose of the ESTTL Spark Setup window is to configure the operation of the first Engine Synchronous TTL (ESTTL1) Output module. The TTL outputs of this module, in the third slot of the [MXIe Expansion Chassis](#), are intended to be used for commands to **smart ignition coils**. The ESTTL Spark Setup window contains a tabbed pane with nine tabs:

[ESTTL 1 TDC Channel Mapping Tab](#): Used for assigning Top Dead Center (TDC) values to each ignition coil commands.

[Ch1-8 Tabs](#): Used for configuring spark command pulse sequences that are associated with each of the eight ESTTL 1 output channels.

Each of the ESTTL 1 output channels are non-multiplexed and therefore can be independently controlled.

The ESTTL module is an optional module for the NI 9155 MXIe Expansion Chassis. This setup window is only applicable if the ESTTL module is inserted in the assigned slot.

4.3.1 ESTTL 1 TDC Channel Mapping Tab

The purpose of the ESTTL 1 TDC Channel Mapping Tab is to assign Top Dead Center (TDC) values to each ignition coil command.

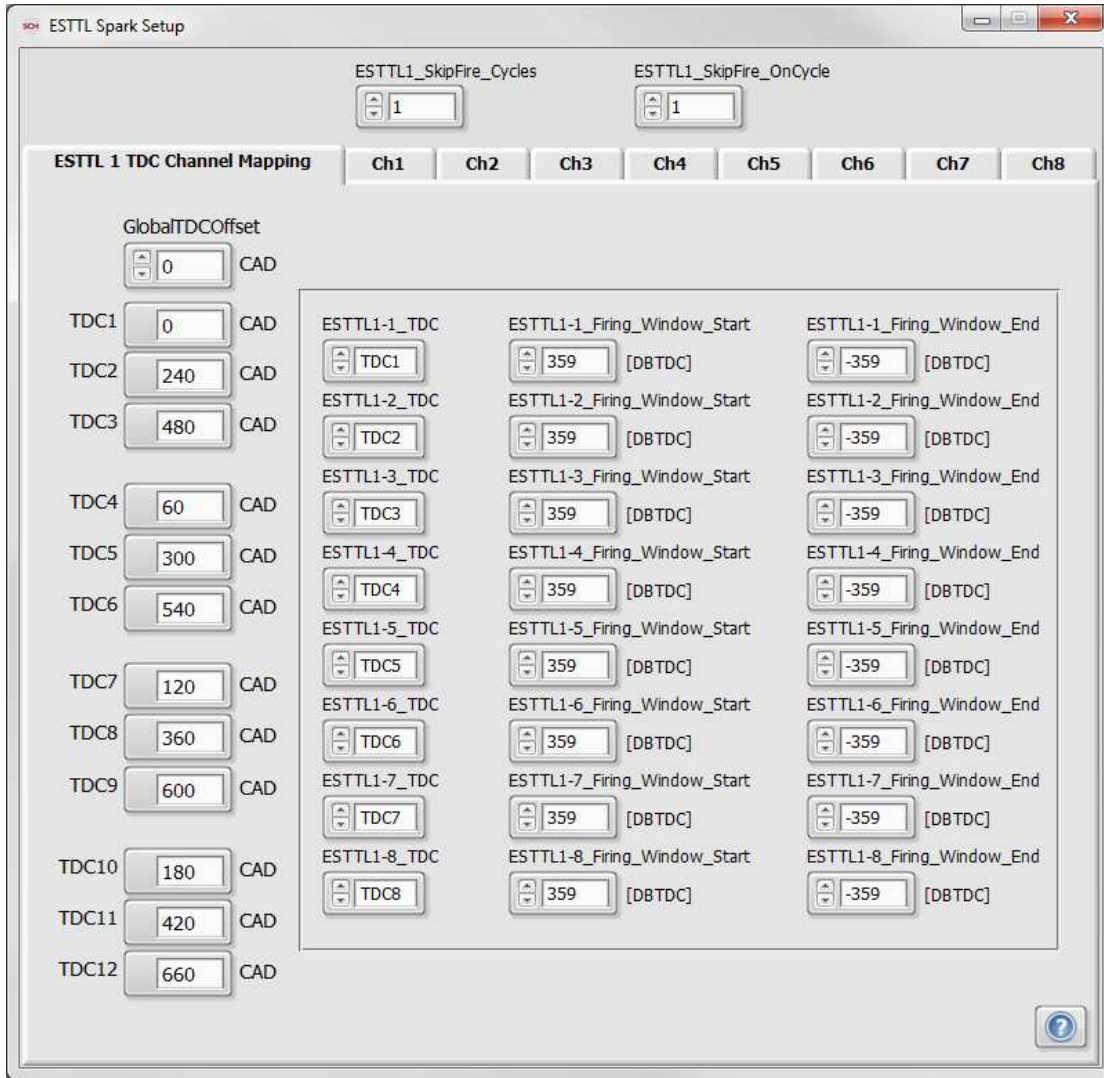

1 ESTTL1_SkipFire_Cycles



Tip Strip: Specifies the period length, in number of cycles, for the Skip Fire Sequence (Min = 1).

Detail: Specifies the number of cycles included in a Skip Fire Sequence. For example, if the number 7 is entered, the ESTTL1 module will output a continuous seven cycle sequence as long as [ESTTL1_SkipFireChanXEnable](#) is enabled for the desired channel.

2 ESTTL1_SkipFire_OnCycle



Tip Strip: Specifies the number of active cycles during Skip Fire Sequence (Min = 1).

Detail: Specifies the number of active cycles included in a Skip Fire Sequence when the DI injector is operated in EPT mode. For example, if the number 4 is entered and [ESTTL1_SkipFire_Cycles](#) is set to 7, the ESTTL1 module will output a continuous seven cycle sequence with four active cycles as long as [ESTTL1_SkipFireChanXEnable](#) is enabled for the desired channel.

3 GlobalTDCOffset

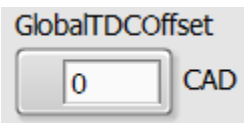

Tip Strip: Global TDC offset between absolute 0 and TDC1

Units: CAD

Detail: Crank angle degrees between the EPT absolute zero position and TDC1. When TDC1 is before EPT absolute zero position, then [GlobalTDCOffset](#) is negative. When TDC1 is after EPT absolute zero position, then [GlobalTDCOffset](#) is positive. The absolute zero position is specific to the [EPT pattern type](#).

4 TDCX

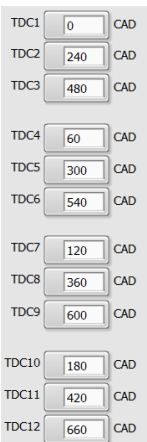

Tip Strip: Top Dead Center

Units: CAD

Detail: Crank angle degrees of offset between the TDC1 and TDCX, where X represents the cylinder number. Typically, engine cylinder #1 will have a TDC of zero because the [GlobalTDCOffset](#) is used to specify CAD between absolute zero and TDC1. The other TDC parameters will have non-zero values, which specify the CAD spacing

with respect to TDC1. The TDC values are mapped to a specific hardware driver channel using the [ESTTL1-X_TDC](#) drop-down list parameters.

5 ESTTL1-X_TDC

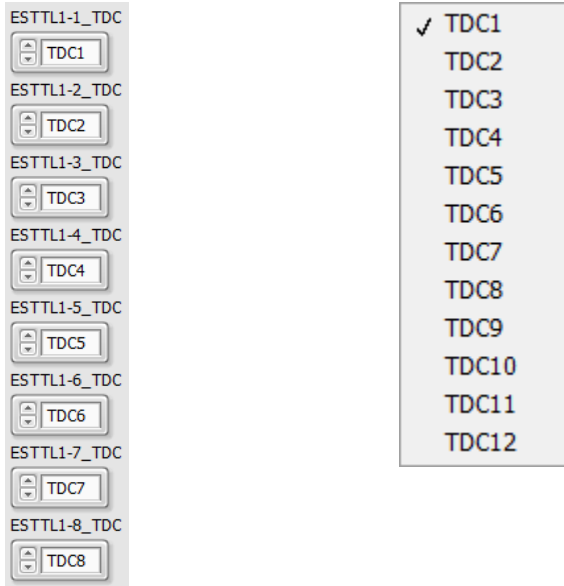

Tip Strip: Selects Top Dead Center reference associated with driver channel

Detail: TDC parameters are mapped to a specific ESTTL1 channel by selecting a [TDCX](#) from the drop-down list in each [ESTTL1-X_TDC](#) parameter, where X is the DI Driver module number and Y is the DI Driver channel number.

6 ESTTL1-X_Firing_Window_Start / ESTTL1-X_Firing_Window_End

ESTTL1-1_Firing_Window_Start 359 [DBTDC]	ESTTL1-1_Firing_Window_End -359 [DBTDC]
ESTTL1-2_Firing_Window_Start 359 [DBTDC]	ESTTL1-2_Firing_Window_End -359 [DBTDC]
ESTTL1-3_Firing_Window_Start 359 [DBTDC]	ESTTL1-3_Firing_Window_End -359 [DBTDC]
ESTTL1-4_Firing_Window_Start 359 [DBTDC]	ESTTL1-4_Firing_Window_End -359 [DBTDC]
ESTTL1-5_Firing_Window_Start 359 [DBTDC]	ESTTL1-5_Firing_Window_End -359 [DBTDC]
ESTTL1-6_Firing_Window_Start 359 [DBTDC]	ESTTL1-6_Firing_Window_End -359 [DBTDC]
ESTTL1-7_Firing_Window_Start 359 [DBTDC]	ESTTL1-7_Firing_Window_End -359 [DBTDC]
ESTTL1-8_Firing_Window_Start 359 [DBTDC]	ESTTL1-8_Firing_Window_End -359 [DBTDC]

Tip Strip: Start of angle-based window around all spark events for a channel, End of angle-based window around all injection events for a channel

Units: DBTDC

Detail: Even though the channels within the ESTTL1 module are independent and the output pulses can overlap, the pulse sequence needs to be reset each engine cycle. The span of this window depends on the stroke of the engine. For example, for 2-Stroke engines, the span is 360 Crank Angles, i.e. ± 180 degrees around the reference TDC. For 4-Stroke engines, the span is 720 Crank Angles (two crank rotations), i.e. ± 360 degrees around the reference TDC. The window may not overlap from cycle to cycle. For example, for 4-Stroke engines, the ESTTL1-X_Firing_Window_Start and ESTTL1-X_Firing_Window_End cannot be exactly 360 and -360 DBTDC respectively. It is recommended that the Start and End windows are offset by One Crank Angle degree from these absolute bounds respectively.

ESTTL1-X_Firing_Window_Start: Defines the start of the window in Degrees Before Top Dead Center (DBTDC). The TDC reference for the window is the [TDCX](#) value associated with the applicable ESTTL1 module channel.

ESTTL1-X_Firing_Window_End: Defines the end of the window in Degrees Before Top Dead Center (DBTDC). The TDC reference for the window is the [TDCX](#) value associated with the applicable ESTTL1 module channel.

4.3.2 ChX Tabs

The purpose of the ChX tabs is to enable individual ESTTL1 channel outputs 1-8, and configure spark pulse generation parameters.

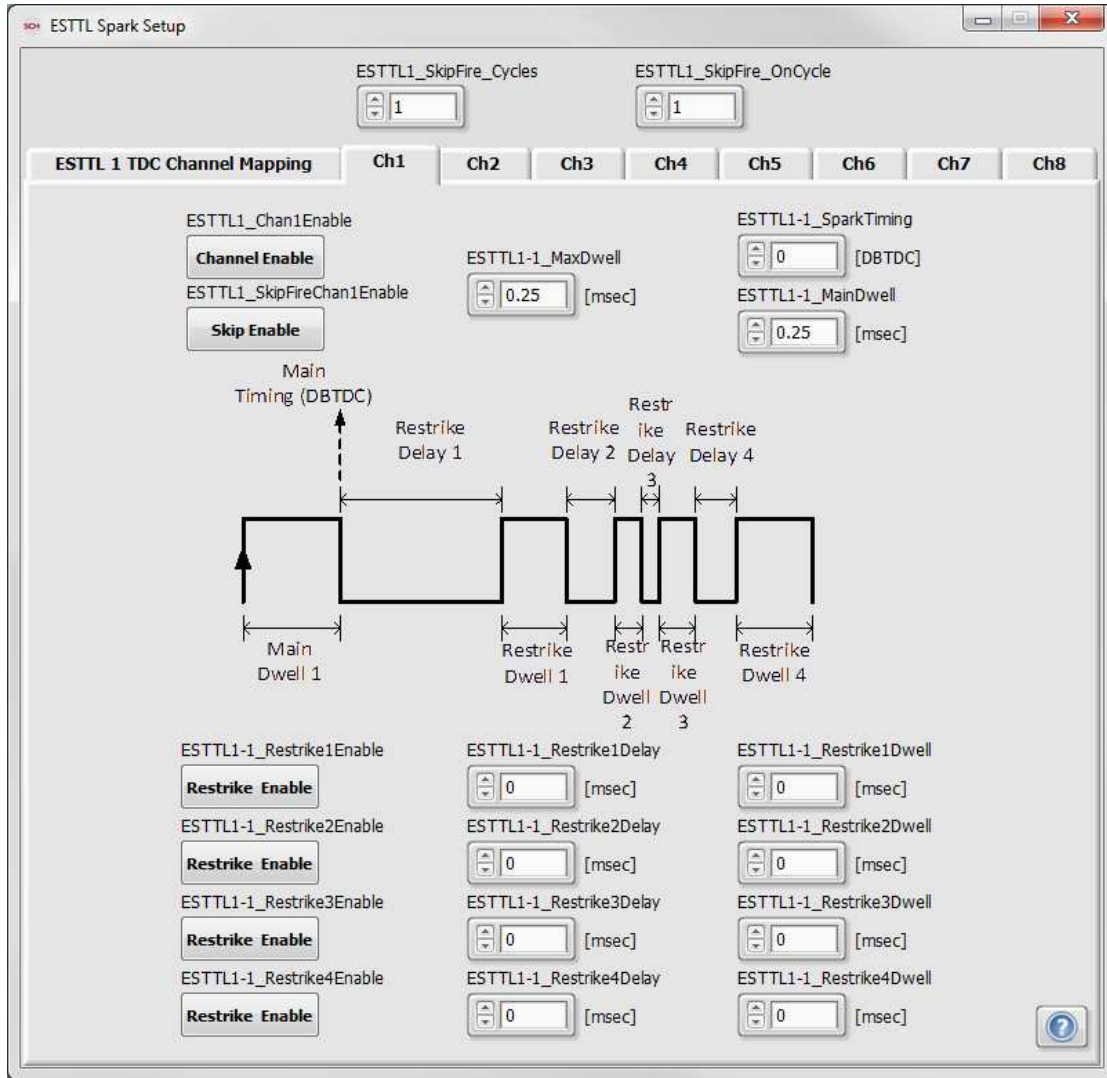

1 ESTTL1_ChanXEnable

ESTTL1_Chan1Enable

Channel Enable

Tip Strip: Enables ESTTL1 Channel output

Detail: Enables engine synchronous TTL output pulses according to specified Main and Restrike pulses.

2 ESTTL1_SkipFireChanXEnable

ESTTL1_SkipFireChan1Enable

Skip Enable

Tip Strip: Enables Skip Fire on ESTTL1 Channel

Detail: Enables the skip fire sequence on a particular ESTTL1 channel as specified by [ESTTL1_SkipFire_Cycles](#) and [ESTTL1_SkipFire_OnCycle](#).

3 ESTTL1-X_MaxDwell

ESTTL1-1_MaxDwell

0 [msec]

Tip Strip: Maximum allowable Main spark dwell

Units: msec

Detail: Specifies the maximum allowable spark dwell associated with an ESTTL1 channel. If the main dwell [ESTTL1-X_MainDwell](#) is set to a value greater than the max dwell ESTTL1-X_MaxDwell value, the main spark pulse will be cut short at the max dwell value.

4 ESTTL1-X_SparkTiming

ESTTL1-1_SparkTiming

0 [DBTDC]

Tip Strip: Main spark timing

Units: DBTDC

Detail: Spark is generated with a trailing edge coinciding with Main spark timing (see Figure 4.3.2.1 1). The length of the main spark pulse will be according to what is specified in the [ESTTL1-X_MainDwell](#). The leading edge will be determined by the current requested Dwell and the current engine speed. [ESTTL1-X_SparkTiming](#) will always take precedence over [ESTTL1-X_MainDwell](#) in the presence of engine speed fluctuations. If the engine speed increases after the spark pulse has started, then the actual dwell will be slightly shorter than the requested Dwell to ensure that correct spark timing is achieved. Likewise, if the engine speed decreases after the spark pulse has started, then the actual dwell will be slightly longer than the requested Dwell.

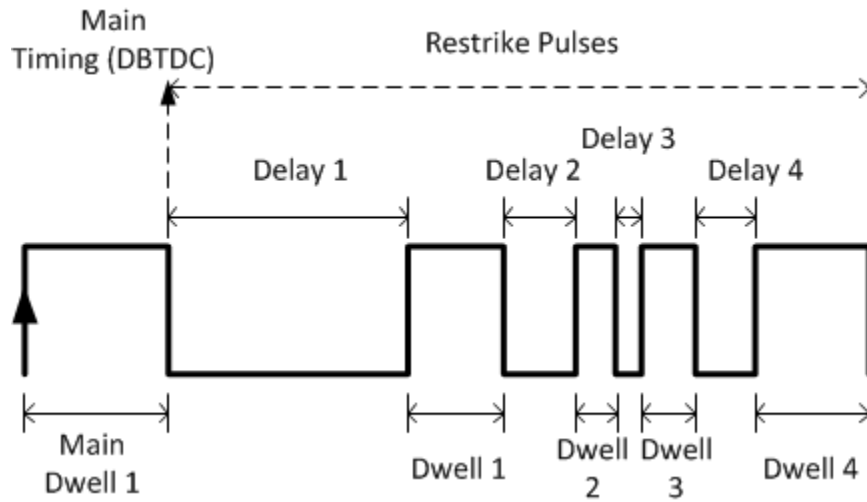

Figure 4.3.2.1 1 Pulse Train illustration for Spark Main and four Restrike pulses

5 ESTTL1-X_RestrikeYEnable

ESTTL1-1_Restrike1Enable

Restrike Enable

Tip Strip: Enables a spark restrike pulse

Detail: Enables Restrike pulse Y associated with channel X on ESTTL 1 module.

6 ESTTL1-X_RestrikeYDelay

ESTTL1-1_Restrike1Delay

0 [msec]

Tip Strip: Delay of a spark restrike pulse with respect to the end of a preceding pulse command

Units: msec

Detail: Specifies a delay (in msec) of a spark restrike pulse Y with respect to the trailing edge of a preceding pulse command (see Figure 4.3.2.1 1 for illustration).

7 ESTTL1-X_RestrikeYDwell

ESTTL1-1_Restrike1Dwell

0 [msec]

Tip Strip: Spark Restrike dwell

Units: msec

Detail: Specifies the time duration of Y spark Restrike dwell (see Figure 4.3.2.1 1 for illustration).

4.4 General Purpose ESTTL Setup Window

The purpose of the General Purpose ESTTL Setup window is to configure the operation of the second Engine Synchronous TTL Output module. The TTL outputs of this module, which resides in the fourth slot of the MXI Expansion chassis, are intended to be used for commands to auxiliary devices such as laser or high speed camera systems for optical engine diagnostics and measurements. The ESTTL Spark Setup window contains a tabbed pane with two tabs:

[ESTTL 2 TDC Channel Mapping Tab](#): Used for assigning Top Dead Center (TDC) reference values to each auxiliary digital command pulse.

[ESTTL 2 Pulse Generation Setup Tab](#): Used for configuring auxiliary digital pulse that is associated with each of the eight ESTTL 2 output channels.

Each of the ESTTL 2 output channels are non-multiplexed and therefore can be independently controlled.

The ESTTL module is an optional module for the NI 9155 MXIe Expansion Chassis. This setup window is only applicable if the ESTTL module is inserted in the assigned slot.

GRAMMAR!!!!

4.4.1 ESTTL 2 TDC Channel Mapping Tab

The purpose of the ESTTL 2 TDC Channel Mapping Tab is to assign Top Dead Center (TDC) reference values to each auxiliary digital command.

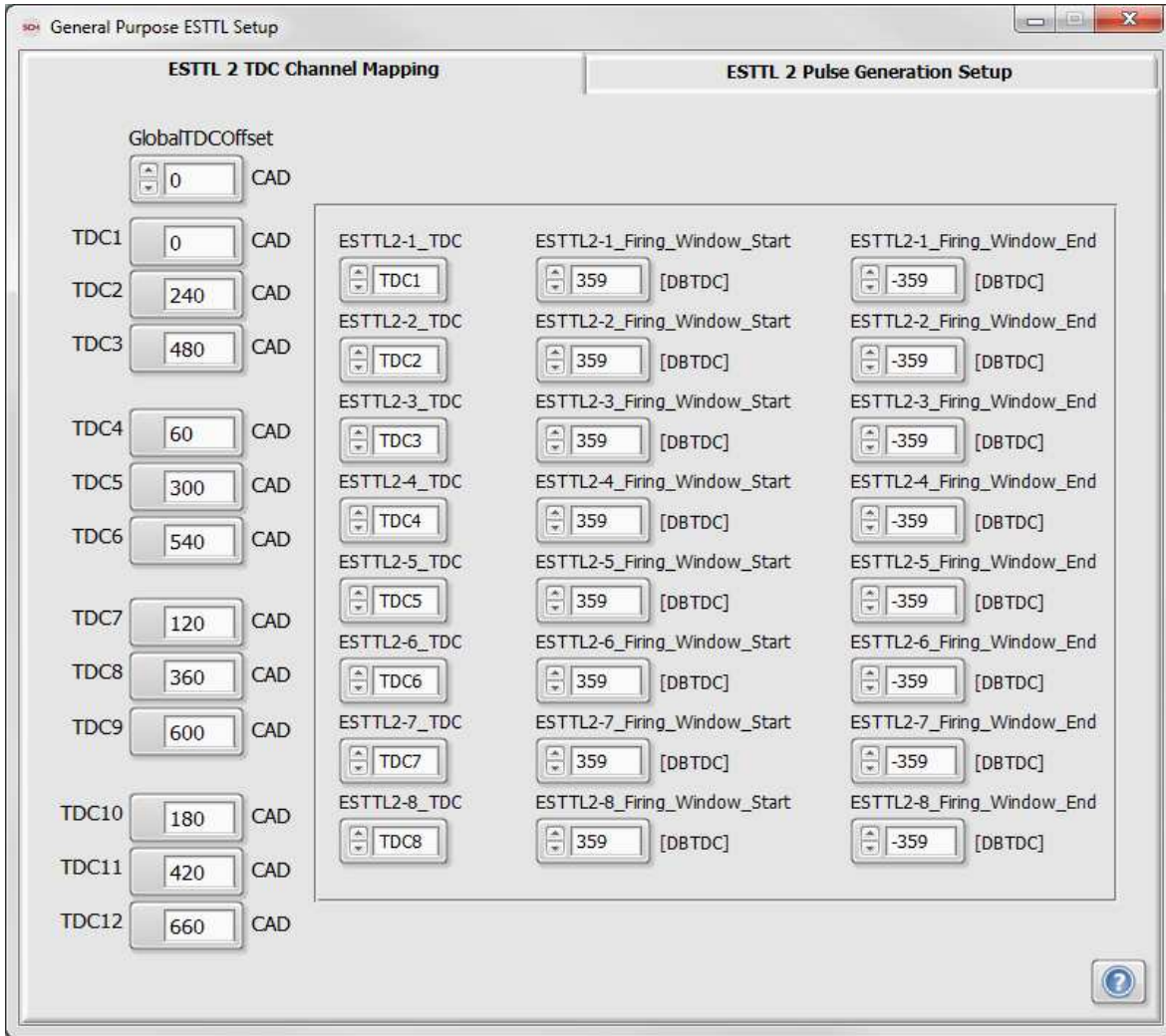

1 GlobalTDCOffset

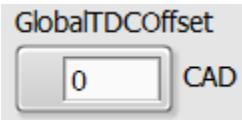

Tip Strip: Global TDC offset between absolute 0 and TDC1

Units: CAD

Detail: Crank angle degrees between the EPT absolute zero position and TDC1. When TDC1 is before EPT absolute zero position, then [GlobalTDCOffset](#) is negative. When TDC1 is after EPT absolute zero position, then [GlobalTDCOffset](#) is positive. The absolute zero position is specific to the [EPT pattern type](#).

2 TDCX

TDC1	<input type="text" value="0"/>	CAD
TDC2	<input type="text" value="240"/>	CAD
TDC3	<input type="text" value="480"/>	CAD
TDC4	<input type="text" value="60"/>	CAD
TDC5	<input type="text" value="300"/>	CAD
TDC6	<input type="text" value="540"/>	CAD
TDC7	<input type="text" value="120"/>	CAD
TDC8	<input type="text" value="360"/>	CAD
TDC9	<input type="text" value="600"/>	CAD
TDC10	<input type="text" value="180"/>	CAD
TDC11	<input type="text" value="420"/>	CAD
TDC12	<input type="text" value="660"/>	CAD

Tip Strip: Top Dead Center

Units: CAD

Detail: Crank angle degrees of offset between the TDC1 and TDCX, where X represents the cylinder number. Typically, engine cylinder #1 will have a TDC of zero because the [GlobalTDCOffset](#) is used to specify CAD between absolute zero and TDC1. The other TDC parameters will have non-zero values, which specify the CAD spacing with respect to TDC1. The TDC values are mapped to a specific hardware driver channel using the [ESTTL2-X_TDC](#) drop-down list parameters.

3 ESTTL2-X_TDC

ESTTL2-1_TDC	<input type="text" value="TDC1"/>	<input checked="" type="checkbox"/> TDC1 <input type="checkbox"/> TDC2 <input type="checkbox"/> TDC3 <input type="checkbox"/> TDC4 <input type="checkbox"/> TDC5 <input type="checkbox"/> TDC6 <input type="checkbox"/> TDC7 <input type="checkbox"/> TDC8 <input type="checkbox"/> TDC9 <input type="checkbox"/> TDC10 <input type="checkbox"/> TDC11 <input type="checkbox"/> TDC12
ESTTL2-2_TDC	<input type="text" value="TDC2"/>	
ESTTL2-3_TDC	<input type="text" value="TDC3"/>	
ESTTL2-4_TDC	<input type="text" value="TDC4"/>	
ESTTL2-5_TDC	<input type="text" value="TDC5"/>	
ESTTL2-6_TDC	<input type="text" value="TDC6"/>	
ESTTL2-7_TDC	<input type="text" value="TDC7"/>	
ESTTL2-8_TDC	<input type="text" value="TDC8"/>	

Tip Strip: Selects Top Dead Center reference associated with driver channel

Detail: TDC parameters are mapped to a specific ESTTL2 channel by selecting a [TDCX](#) from the drop-down list in each [ESTTL2-X_TDC](#) parameter, where X is the DI Driver module number and Y is the DI Driver channel number.

4

ESTTL2-X_Firing_Window_Start / ESTTL2-X_Firing_Window_End

ESTTL2-1_Firing_Window_Start <input type="text" value="359"/> [DBTDC]	ESTTL2-1_Firing_Window_End <input type="text" value="-359"/> [DBTDC]
ESTTL2-2_Firing_Window_Start <input type="text" value="359"/> [DBTDC]	ESTTL2-2_Firing_Window_End <input type="text" value="-359"/> [DBTDC]
ESTTL2-3_Firing_Window_Start <input type="text" value="359"/> [DBTDC]	ESTTL2-3_Firing_Window_End <input type="text" value="-359"/> [DBTDC]
ESTTL2-4_Firing_Window_Start <input type="text" value="359"/> [DBTDC]	ESTTL2-4_Firing_Window_End <input type="text" value="-359"/> [DBTDC]
ESTTL2-5_Firing_Window_Start <input type="text" value="359"/> [DBTDC]	ESTTL2-5_Firing_Window_End <input type="text" value="-359"/> [DBTDC]
ESTTL2-6_Firing_Window_Start <input type="text" value="359"/> [DBTDC]	ESTTL2-6_Firing_Window_End <input type="text" value="-359"/> [DBTDC]
ESTTL2-7_Firing_Window_Start <input type="text" value="359"/> [DBTDC]	ESTTL2-7_Firing_Window_End <input type="text" value="-359"/> [DBTDC]
ESTTL2-8_Firing_Window_Start <input type="text" value="359"/> [DBTDC]	ESTTL2-8_Firing_Window_End <input type="text" value="-359"/> [DBTDC]

Tip Strip: Start of angle-based window around all engine synchronous TTL-trigger-based events for a channel, End of angle-based window around all injection events for a channel

Units: DBTDC

Detail: Even though the channels within the ESTTL2 module are independent and the output pulses can overlap, the pulse sequence needs to be reset each engine cycle. The span of this window depends on the stroke of the engine. For example, for 2-Stroke engines, the span is 360 Crank Angles, i.e. ± 180 degrees around the reference TDC. For 4-Stroke engines, the span is 720 Crank Angles (two crank rotations), i.e. ± 360 degrees around the reference TDC. The window may not overlap from cycle to cycle. For example, for 4-Stroke engines, the ESTTL2-X_Firing_Window_Start and ESTTL2-X_Firing_Window_End cannot be exactly 360 and -360 DBTDC respectively. It is recommended that the Start and End windows are offset by One Crank Angle degree from these absolute bounds respectively.

ESTTL2-X_Firing_Window_Start: Defines the start of the window in Degrees Before Top Dead Center (DBTDC). The TDC reference for the window is the [TDCX](#) value associated with the applicable ESTTL 2 module channel.

ESTTL2-X_Firing_Window_End: Defines the end of the window in Degrees Before Top Dead Center (DBTDC). The TDC reference for the window is the [TDCX](#) value associated with the applicable ESTTL 2 module channel.

4.4.2 ESTTL 2 Pulse Generation Setup Tab

The purpose of the ESTTL 2 Pulse Generation Setup Tab is to enable individual ESTTL 2 channel outputs 1-8, and configure auxiliary digital command pulses.

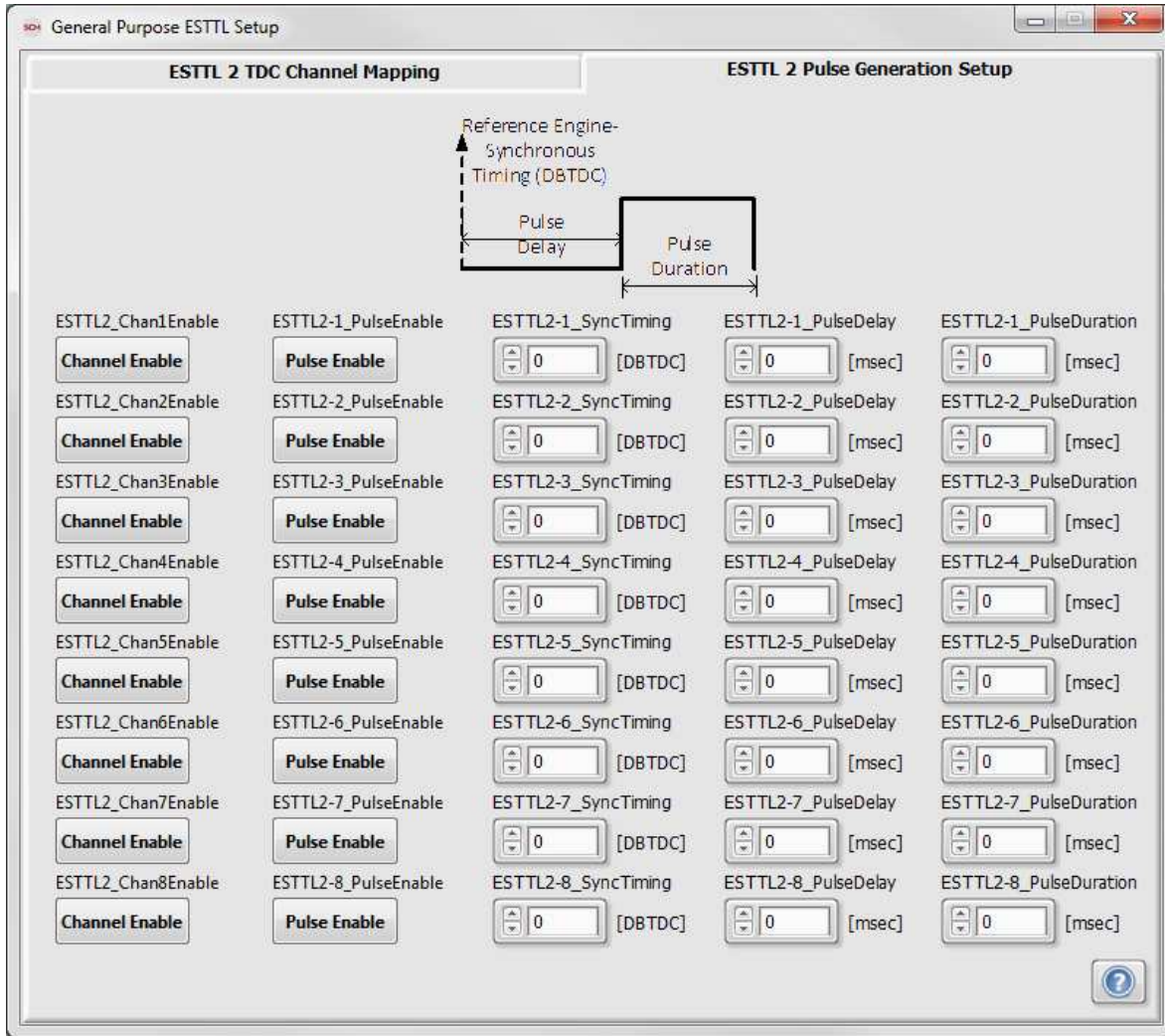

1 ESTTL2_ChanXEnable

ESTTL2_Chan1Enable

Channel Enable

Tip Strip: Enables ESTTL 2 Channel output

Detail: Enables engine synchronous TTL output pulses according to specified Main and Restrike pulses.

2 ESTTL2-X_PulseEnable

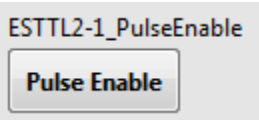

Tip Strip: Enables an auxiliary engine synchronous pulse

Detail: Enables engine synchronous TTL output pulse according to specified pulse delay and duration.

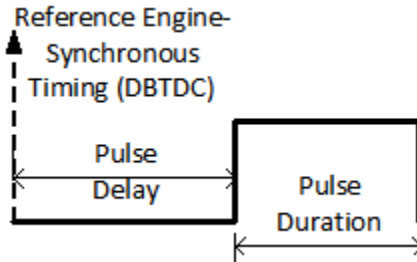
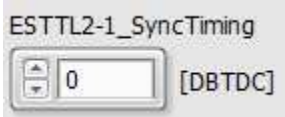

Figure 4.4.2 1 Pulse Train illustration for Auxiliary Digital pulses

3 ESTTL2-X_SyncTiming



Tip Strip: Sync timing for auxiliary pulse generation with respect to a reference TDC

Units: DBTDC

Detail: An angle-based timing with respect to TDCX that is used as a reference for auxiliary digital pulse (see [Figure 4.4.2 1](#) for illustration).

4 ESTTL2-X_PulseDelay

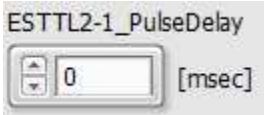

Tip Strip: Delay of an auxiliary pulse with respect to an engine synchronous position

Units: msec

Detail: Specifies a delay (in msec) of auxiliary digital pulse with respect to ESTTL2-X_SyncTiming (see [Figure 4.4.2 1](#) for illustration).

5 ESTTL2-X_PulseDwell

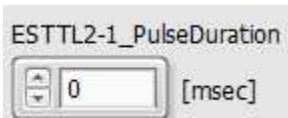

Tip Strip: Auxiliary Pulse duration

Units: msec

Detail: Specifies the time duration of auxiliary digital pulse (see [Figure 4.4.2 1](#) for illustration).

4.5 Throttle Driver Setup Window

The purpose of the Throttle Driver Setup window is to configure the operation of the throttle driver module. The window consists of a pane containing module parameters and a tabbed pane containing two channel tabs marked Channel 1 and Channel 2. Within a channel tab, there is another tabbed pane containing three tabs:

[Channel X Control Tab](#): Used for configuring a throttle channel including: enabling the channel, setting operating mode of a throttle channel and assigning position control setpoints.

[Channel X Position Calibration](#): Used for configuring/monitoring a group of parameters related to the throttle position calibration process associated with throttle Channel X.

[Channel X Control Calibration](#): Used for configuring a collection of calibration parameters used to control throttle position associated with throttle Channel X.

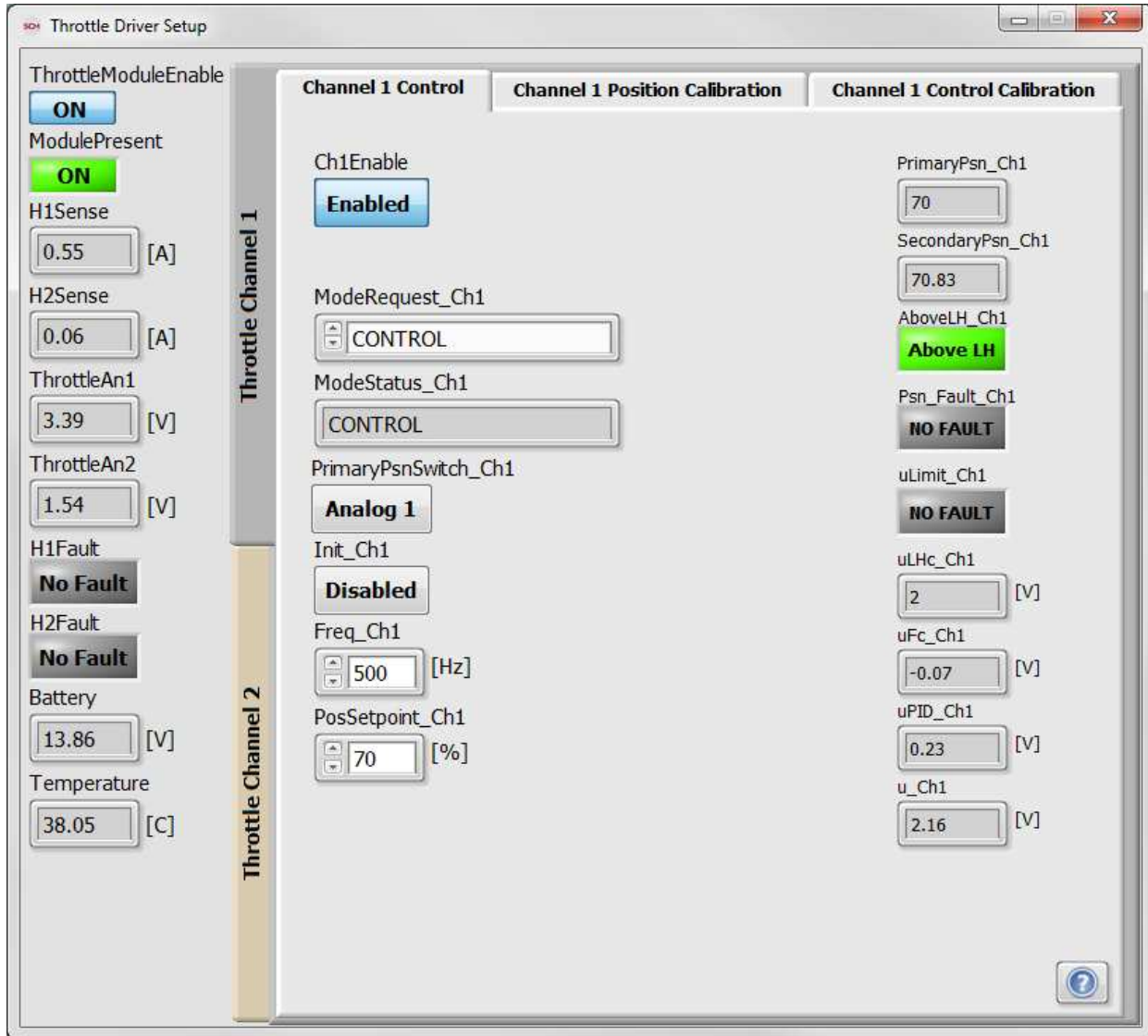

1 ThrottleModuleEnable

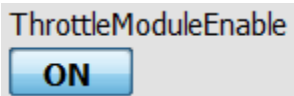

Tip Strip: Enables Throttle Driver Module operation

Detail: If a Throttle driver module is inserted in the [assigned slot](#), [externally powered](#), and [ThrottleModuleEnable](#) is **ON**, then the controller begins communicating with the module and allows the module to operate.

2 ModulePresent



Tip Strip: Indicates Throttle Driver module present and externally powered

Detail: Indicates the presence and recognition of the associated Throttle Driver module. The module will only be recognized when [ThrottleModuleEnable](#) is **ON**, a Throttle Driver module is inserted in the [assigned slot](#), and the module is properly [externally powered](#).

3 HXSense

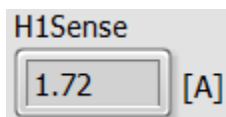

Tip Strip: H-Bridge channel X current draw

Units: A

Detail: The filtered load current of h-bridge circuit X in Amps.

4 ThrottleAnX

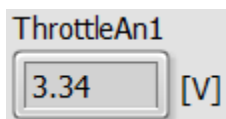

Tip Strip: Filtered voltage of external analog input X

Units: V

Detail: The filtered voltage of external analog input X typically from a potentiometer in a throttle body to indicate position feedback.

5 HXFault

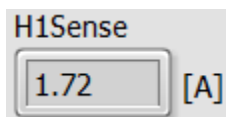

Tip Strip: H-Bridge channel X Fault indicator

Detail: When TRUE, then an over-current or over-temperature fault has occurred with h-bridge circuit 1 and operation will be interrupted until the fault is removed.

6 Battery

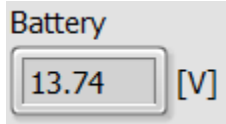

Tip Strip: Battery voltage measured by the H-Bridge channel driver module

Detail: The filtered battery voltage supplied to the module.

7 Temperature

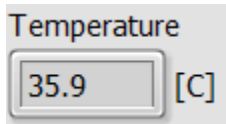

Tip Strip: H-Bridge channel driver module temperature

Detail: The filtered internal module temperature.

4.5.1 Channel X Control Tab

The purpose of the Channel X Control Tab is to configure a particular throttle module channel.

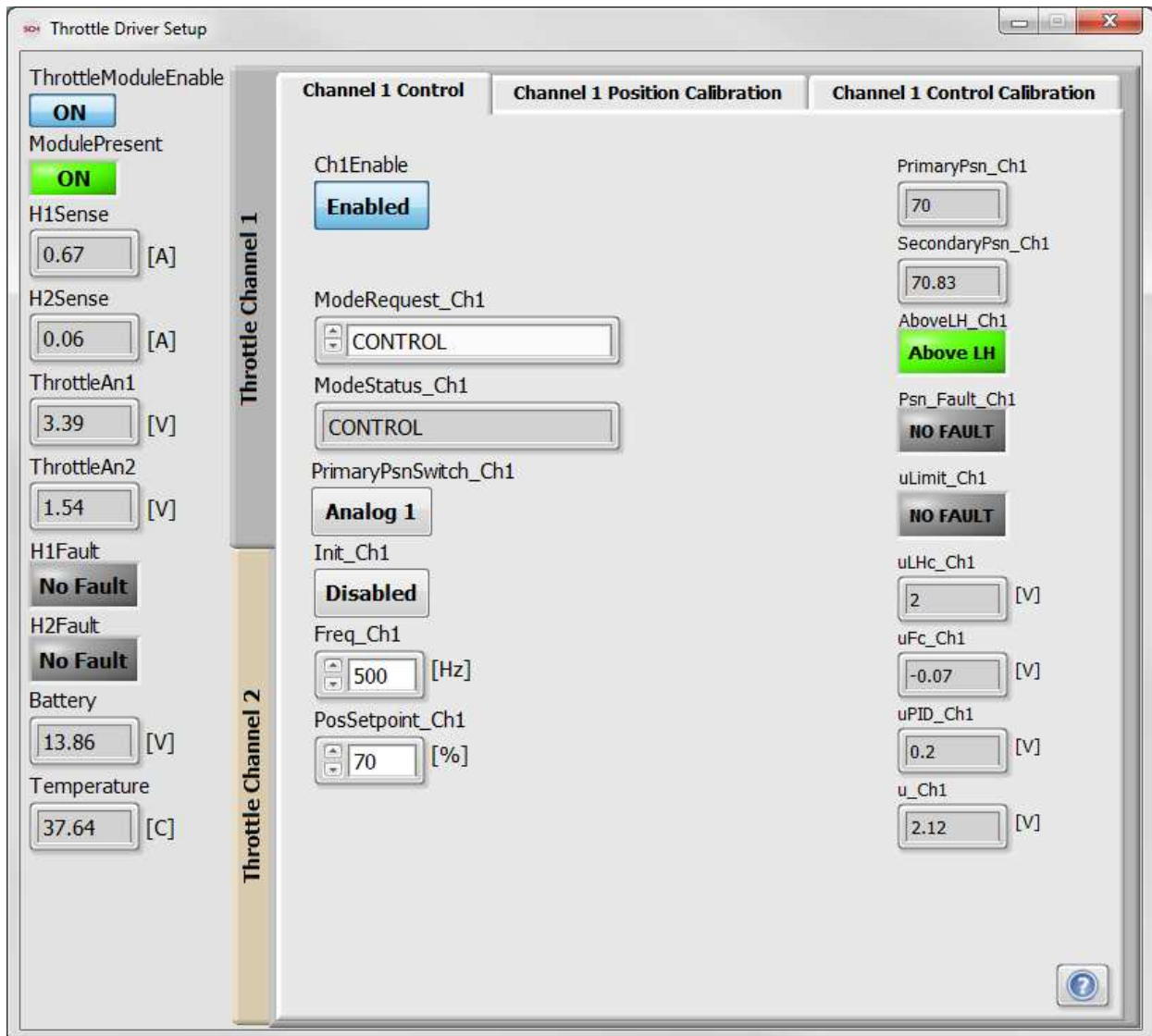

1 ChXEnable

Ch1Enable

Enabled

Tip Strip: Enable H-Bridge channel X

Detail: When this button is enabled and ModulePresent is lit (ON), H-bridge channel X is enabled

2 ModeRequest_ChX

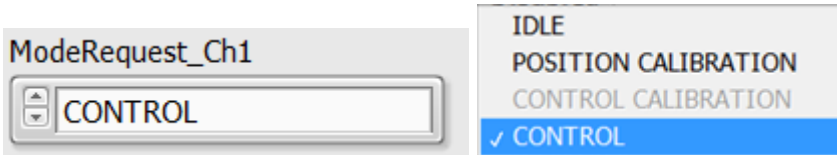

Tip Strip: Sets the requested throttle mode.

Detail: Requested operating mode for throttle Channel X.

IDLE : The throttle motor voltage is 0V. Primary Position is calculated according to Position Calibration Out parameters.

POSITION CALIBRATION : This mode can only be entered when ModeStatus_ChX is IDLE. Starts the position calibration process, guided by Position Cal Settings cluster parameters. This mode will remain and repeat until the ModeRequest is changed. When ModeRequest is changed to IDLE, the ModeStatus will immediately change to IDLE. When ModeRequest is changed to CONTROL, the ModeStatus will change to CONTROL upon completion of the current position calibration process.

CONTROL CALIBRATION : This mode can only be entered when ModeStatus_ChX is IDLE. Starts the control calibration process, guided by Control Cal Settings cluster parameters. When the control calibration process is complete, Mode Status returns to IDLE. This operating mode is not currently implemented and forces the Mode Status back to IDLE.

CONTROL : This mode can only be entered when ModeStatus_ChX is IDLE. This mode controls the throttle position to the Position Setpoint input. This mode is exited only when Mode Request is set to IDLE. It is not possible to move directly from this mode to a Position Calibration or Control Calibration mode.

3 ModeStatus_ChX

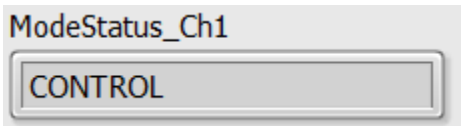

Tip Strip: Indicates the throttle mode status.

Detail: Status of operating mode for Channel X. See detail of ModeRequest_ChX for description of each operating mode.

4 PrimaryPsnSwitch_ChX



Tip Strip: Indicates the Position Calibration currently in use for the Primary Position.

Detail: Determines which analog input within the Module Data cluster is the primary position sensor signal and which is the secondary position sensor signal.

FALSE :

Use Analog1 (V) as the primary position sensor signal.
Use Analog2 (V) as the secondary position sensor signal.

TRUE :

Use Analog2 (V) as the primary position sensor signal.
Use Analog1 (V) as the secondary position sensor signal.

ATTENTION: This parameter should only be modified during IDLE mode. If this input is modified, then initialize must be set to TRUE for the new value to take affect.

5 Init_ChX

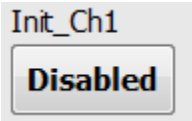

Tip Strip: Captures the Position Cal In and Primary Position inputs for position calibration. Do not set true during CONTROL mode.

Detail: When TRUE, captures the Position Cal In and Primary Position inputs for proper position calibration. Do not set this input to TRUE during CONTROL mode.

6 Freq_ChX

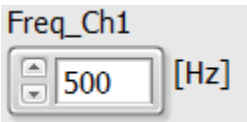

Tip Strip: Switching PWM frequency for driving Throttle actuator

Units: Hz

Detail: Indicates switching Pulse Width Modulation (PWM) frequency for driving Throttle actuator

7 PosSetpoint_ChX

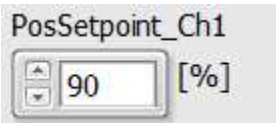

Tip Strip: Throttle Channel X Position Setpoint

Units: %

Detail: Indicates the throttle position setpoint in percentage.

4.5.2 Channel X Position Calibration Tab

The purpose of the Channel X Position Calibration Tab is to configure parameters associated with throttle position calibration.

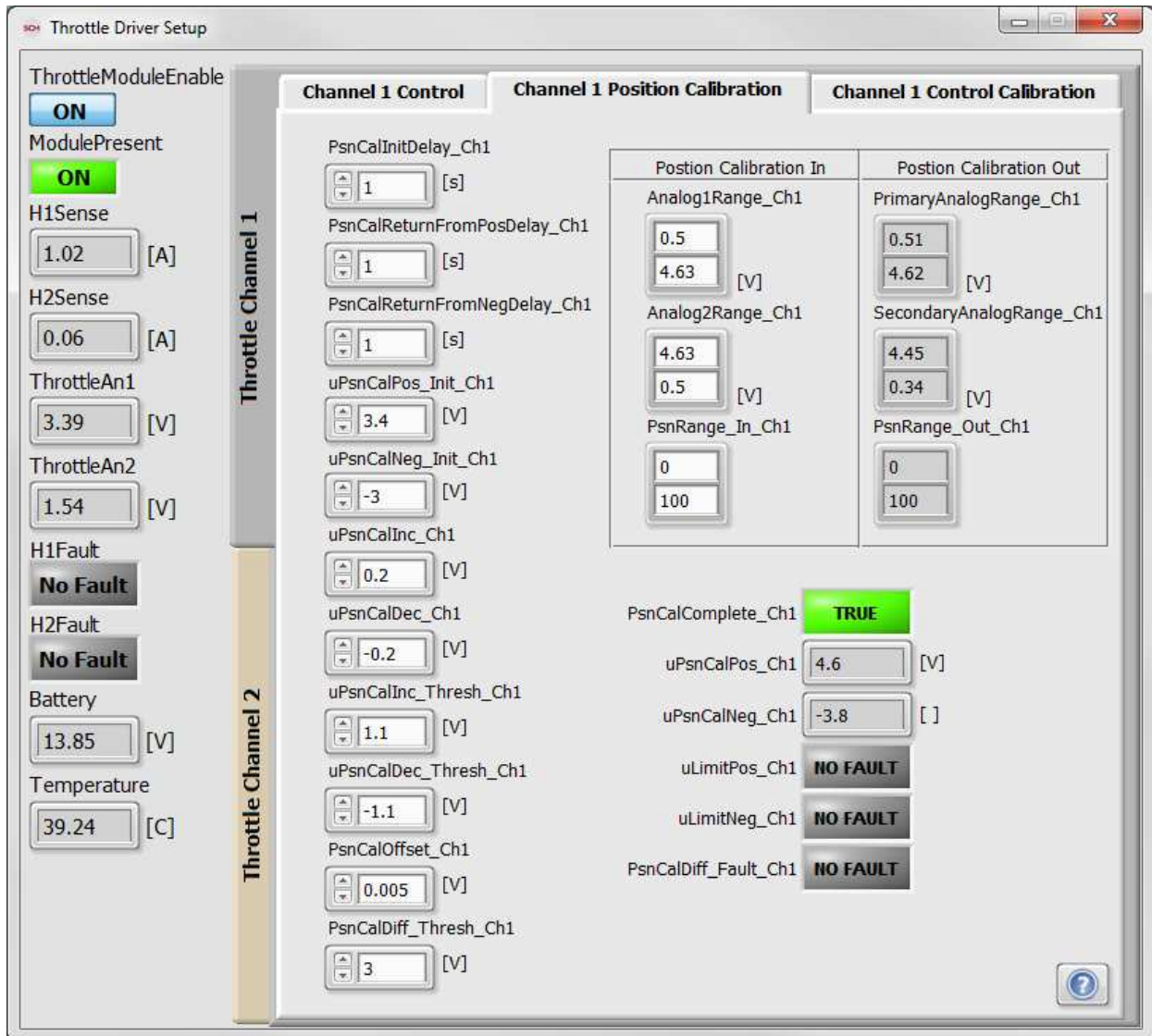

1 PsnCalInitDelay_ChX

PsnCalInitDelay_Ch1

1 [s]

Tip Strip: Time delay from the start of pos cal init to the start of pos cal.

Units: s (seconds)

Detail: Indicates time delay in seconds from the start of position calibration initialization phase to start of positive calibration. This time allows the throttle plate to return to the limp-home position before positive calibration.

2 PsnCalReturnFromPosDelay_ChX

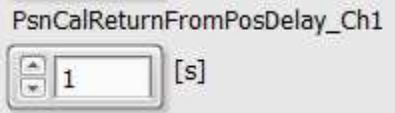

Tip Strip: Time delay from the end of pos cal to the start of neg cal.

Units: s (seconds)

Detail: Indicates time delay (in seconds) from the end of positive position calibration to start of negative calibration. This time must be long enough to allow the throttle plate to return to the limp-home position before negative calibration. Otherwise the limp-home position will not be properly detected.

3 PsnCalReturnFromNegDelay_ChX



Tip Strip: Time delay from the end of neg pos cal to the start of pos cal phase.

Units: s (seconds)

Detail: Indicates time delay (in seconds) from the start of position calibration initialization phase to start of positive calibration. This time allows the throttle plate to return to the limp-home position before positive calibration.

4 uPsnCalPos_Init_ChX

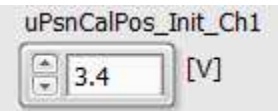

Tip Strip: The initial drive voltage to the throttle motor for positive position calibration. (Positive)

Units: V

Detail: Indicates the initial drive voltage to the throttle motor for positive position calibration. This voltage should be selected to move the throttle plate most of the way toward maximum position without hitting maximum position. This parameter should be a positive value.

5 uPsnCalNeg_Init_ChX

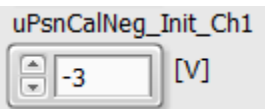

Tip Strip: The initial drive voltage to the throttle motor for negative position calibration. (Negative)

Units: V

Detail: Indicates the initial drive voltage to the throttle motor for negative position calibration. This voltage should be selected to move the throttle plate most of the way toward minimum position without hitting minimum position. This parameter should be a negative value.

6 uPsnCalInc_ChX

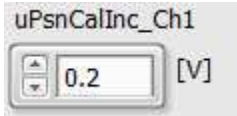

Tip Strip: Incremental drive voltage applied to the throttle motor to keep the throttle plate moving toward the maximum position. (Positive)

Units: V

Detail: Indicates the incremental drive voltage to the throttle motor to keep the throttle plate moving toward maximum position. This incremental value is applied as necessary after the throttle plate stops moving due to the uPsnCalPos_Init_ChX voltage. This parameter should be a positive value.

7 uPsnCalDec_ChX

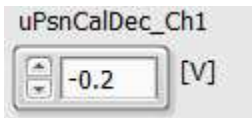

Tip Strip: Decremental drive voltage applied to the throttle motor to keep the throttle plate moving toward the minimum position. (Negative)

Units: V

Detail: Indicates the decremental drive voltage to the throttle motor to keep the throttle plate moving toward minimum position. This decremental value is applied as necessary after the throttle plate stops moving due to the u Pos Cal Negative Init voltage. This parameter should be a negative value.

8 uPsnCalInc_Thresh_ChX

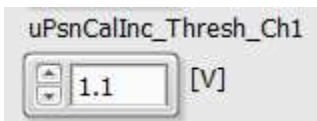

Tip Strip: Threshold for incremental throttle motor positive voltage after the throttle plate stops moving. (Positive)

Units: V

Detail: Indicates a threshold for incremental throttle motor positive voltage after the throttle plate stops moving. When this incremental threshold is reached, the drive stops and transitions to the negative calibration phase. This parameter should be a positive value.

9 uPsnCalDec_Thresh_ChX

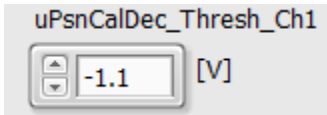

Tip Strip: Threshold for decremental throttle motor negative voltage after the throttle plate stops moving. (Negative)

Units: V

Detail: Indicates a threshold for decremental throttle motor negative voltage after the throttle plate stops moving. When this decremental threshold is reached, the drive stops and transitions to the post calibration phase. This parameter should be a negative value.

10 PsnCalOffset_ChX

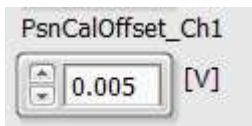

Tip Strip: The amount that the signal must change before the motor voltage increment/decrement reaches the specified threshold, terminating the calibration process for that direction. (Positive)

Units: V

Detail: The position calibration process tracks the primary position sensor signal as the throttle plate moves toward the minimum and maximum positions. This offset is the amount that the signal must change before the motor voltage increment/decrement reaches the specified threshold, terminating the calibration process for that direction.

Typically 0.005 V is adequate. If this parameter is 0, then the calibration process will push harder toward the minimum/maximum positions. When this happens, the minimum and maximum positions can be difficult to achieve during control, and cause the final output to the throttle motor to exceed the limit. This parameter should be a positive value.

11 PsnCalDiff_Thresh_ChX

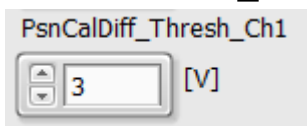

Tip Strip: Minimum threshold for the expected range of throttle plate travel. (Positive)

Units: V

Detail: At the completion of the position calibration process, the absolute value of the difference between the maximum and minimum position sensor signal voltages is compared against this threshold. If it is less than the threshold, then there was something wrong with the position calibration process because the throttle plate did not move through the expected range of travel, or the position sensor is faulty. This fault is indicated by the Pos Cal Diff Fault Boolean indicator within the Position Cal Out cluster.

12 AnalogXRange_ChY

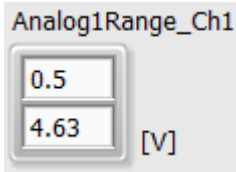

Tip Strip: Only change in Idle mode. Not needed if Position Cal is used. Element 0: Minimum Position V; Element 1: Maximum Position V

Units: V

Detail: Typically, electronic throttle bodies have two position sensors for redundancy. If redundancy is required, the analog inputs of the throttle driver module will be consumed for a single throttle body. If redundancy is not required, two throttle bodies may be used with a single position sensor signal used from each throttle body.

The array AnalogXRange_ChY contains the minimum and maximum position sensor signal voltages for Analog1 and Analog2 channels of the module, respectively.

Element 0 : The position sensor signal voltage which corresponds to the minimum position of the throttle plate.
Element 1 : The position sensor signal voltage which corresponds to the maximum position of the throttle plate.

Notes:
If accurate position sensor signal voltages are already known, then they should be entered to this array and a position calibration process is not necessary. If it is desired to run a calibration process, then the AnalogXRange_ChY values should be initialized with proper values for the calibration process to be successful. The analog input range for the Throttle Driver module is 0 to 5V.

If the polarity of the position sensor output is positive, then enter 0V for element-0 and 5V for element-1.
If the polarity of the position sensor output is negative, then enter 5V for element-0 and 0V for element-1.

Typically, electronic throttle bodies have redundant position sensors such that one of the signals will have positive polarity and the other will have negative polarity.

13 PsnRange_In_ChX

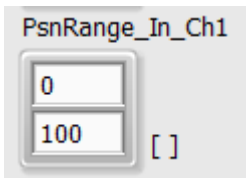

Tip Strip: Only change in Idle mode. Not needed if Position Cal is used. Element 0: Minimum Position; Element 1: Maximum Position

Units: % or degrees

Detail: This array contains the position range of the throttle plate. The units for Position Range are arbitrary and correspond to the same units for Position Setpoint input and Primary Position output.

Element 0 : The minimum position.
Element 1 : The maximum position.

14 PrimaryAnalogRange_ChX

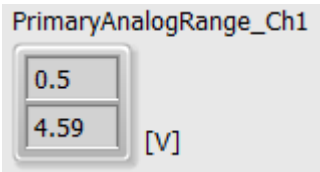

Tip Strip: Indicates the Position Cal currently in use for the Primary Position.

Units: V

Detail: Upon the first call of this application, Position Calibration Out will reflect the corresponding values of Position Calibration In.

If the calibration process is not run, then Position Calibration Out will continue to reflect the corresponding values of Position Calibration In.

If the calibration process is run, then Position Cal Out parameters will be updated to the values learned from the calibration process.

The PrimaryAnalogRange array will be set according to the value of **PrimaryPsnSwitch_ChX** Boolean input.

15 SecondaryAnalogRange_ChX

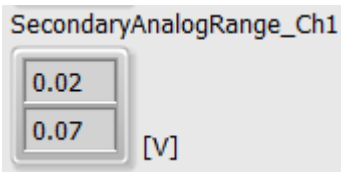

Tip Strip: Indicates the Position Cal currently in use for the Secondary Position.

Units: V

Detail: Upon the first call of this application, Position Calibration Out will reflect the corresponding values of Position Calibration In.

If the calibration process is not run, then Position Calibration Out will continue to reflect the corresponding values of Position Calibration In.

If the calibration process is run, then Position Cal Out parameters will be updated to the values learned from the calibration process.

The SecondaryAnalogRange array will be set according to the value of **PrimaryPsnSwitch_ChX** Boolean input.

16 PsnCalComplete_ChX

PsnCalComplete_Ch1 **TRUE**

Tip Strip: Indicates successful completion of the position calibration process.

Detail: Indicates whether a successful calibration process was completed. This Boolean will NOT be set to TRUE if either of the following Booleans are set to TRUE:

uLimitPos_ChX
uLimitNeg_ChX

17 uLimitPos_ChX

uLimitPos_Ch1 **NO FAULT**

Tip Strip: Indicates driver voltage limits are exceeded during positive position calibration.

Detail: Indicates the maximum positive voltage applied to the throttle motor upon finding the maximum position sensor signal.

18 uLimitNeg_ChX

uLimitNeg_Ch1 **NO FAULT**

Tip Strip: Indicates driver voltage limits are exceeded during negative position calibration.

Detail: Indicates the maximum negative voltage applied to the throttle motor upon finding the minimum position sensor signal.

19 PsnCalDiff_Fault_ChX

PsnCalDiff_Fault_Ch1 **NO FAULT**

Tip Strip: Indicates the threshold difference between min and max positions were not met during Position Cal.

Detail: At the completion of the position calibration process, the absolute value of the difference between the maximum and minimum position sensor signal voltages is compared againsts the Pos Cal Diff Thresh (V) within the Position Cal Settings cluster. If is is less than the threshold, then there was something wrong with the position calibration process because the throttle plate did not move through the expected range of travel, or the position sensor is faulty. Such a fault is indicated by this Boolean when TRUE, and Position Calibrated will be set to FALSE upon completion of the calibration process.

4.5.3 Channel X Control Calibration Tab

The purpose of the Channel X Position Calibration Tab is to configure parameters associated with controlling throttle position. Prior to a position calibration and control calibration, The Control Calibration Out values will exactly reflect the values of the corresponding Control Calibration In cluster. Some of the Control Calibration Out parameters will be modified following a position calibration and/or control calibration. The modified values will be shown in the Control Calibration Out cluster.

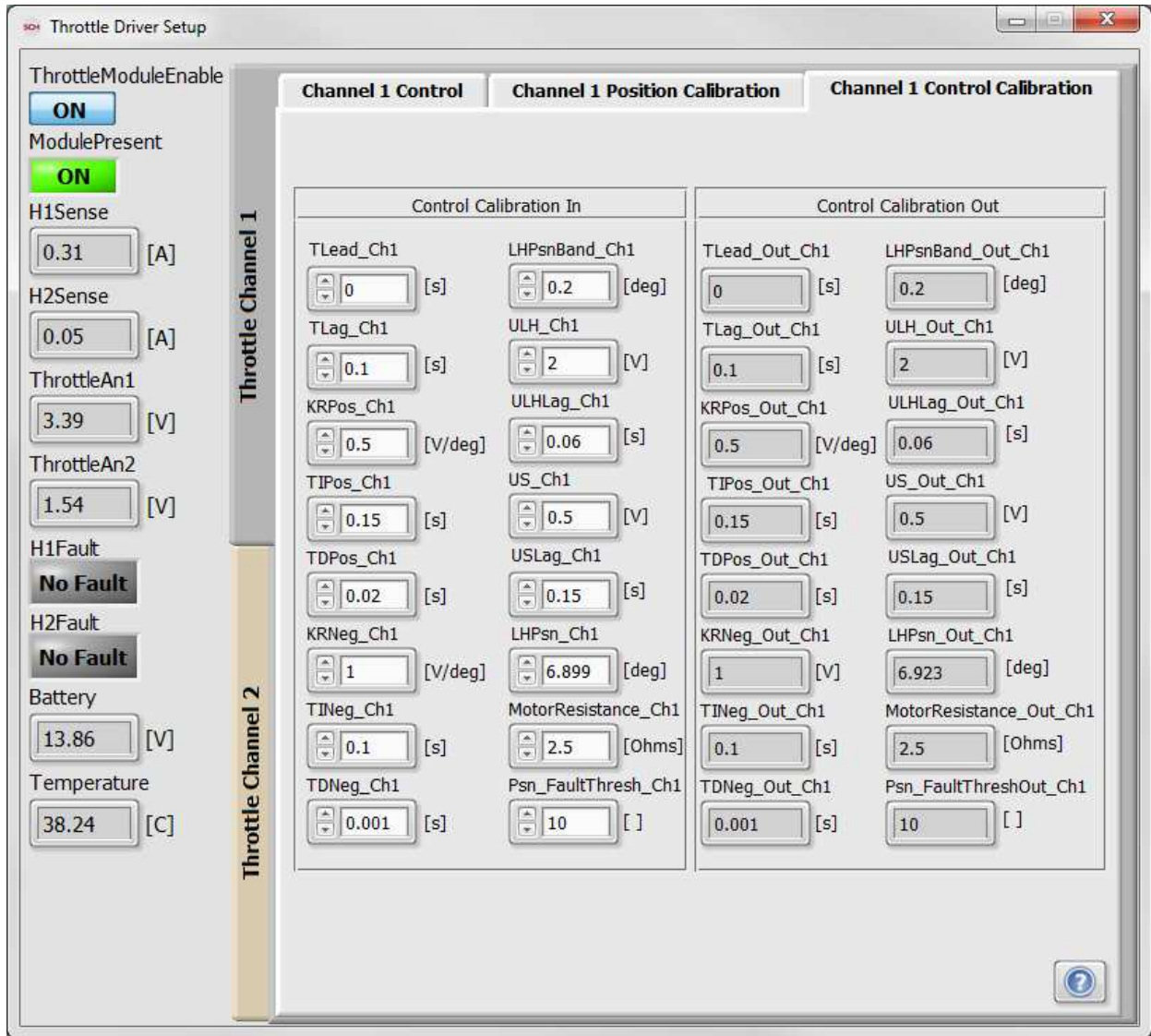

1 TLead_ChX



Tip Strip: H-Bridge channel 1 lead compensation time

Units: s (seconds)

Detail: Adjusts the lead compensation on the **PosSetpoint_ChX**. A lead/lag compensation function is internally inserted in the **PosSetpoint_ChX** value to the internal PID function. **TLead_ChX** can be increased to intensify the change in Position Setpoint. This parameter is not changed by a position or control calibration procedure.

2 TLag_ChX

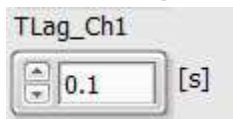

Tip Strip: H-Bridge channel X lag compensation time

Units: s (seconds)

Detail: Adjusts the lag compensation on the **PosSetpoint_ChX** value. A lead/lag compensation function is internally inserted in the **PosSetpoint_ChX** value to the internal PID function. **TLag_ChX** can be increased to slow the change in Position Setpoint. This parameter is not changed by a position or control calibration procedure.

3 KRPos_ChX

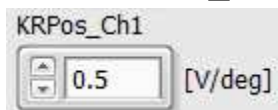

Tip Strip: H-Bridge channel X proportional gain for H-Bridge channel PID when Theta is greater than limp home angle

Units: V/

Detail: Specifies proportional gain for the throttle control PID function while **PosSetpoint_ChX** is greater than **LHPsn_Out_ChX** Limp Home position in the Control Calibration Out column. This parameter is changed by a control calibration procedure.

4 TIPos_ChX

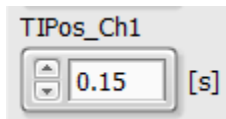

Tip Strip: H-Bridge channel X integral time for PID when Theta is greater than limp home angle

Units: s (seconds)

Detail: Specifies Integral time for the throttle control PID function while **PosSetpoint_ChX** is greater than **LHPsn_Out_ChX** Limp Home position. The integral time is equivalent to the electro-mechanical time-constant of the throttle body. Smaller integral times intensify the integral action. When TI is set to zero, the integral action is disabled. This parameter is changed by a control calibration procedure.

5 TDPos_ChX

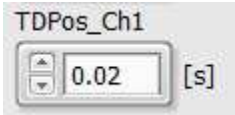

Tip Strip: H-Bridge channel X derivative time for PID when Theta is greater than limp home angle

Units: s (seconds)

Detail: Specifies Derivative time for the throttle control PID function while **PosSetpoint_ChX** is greater than **LHPsn_Out_ChX** Limp Home position. The derivative time is proportional to the electro-mechanical time-constant of the throttle body. Larger times intensify the derivative action. When TD is set to zero, the derivative action is disabled. This parameter is changed by a control calibration procedure.

6 KRNeg_ChX

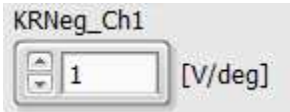

Tip Strip: H-Bridge channel X proportional gain for H-Bridge channel PID when Theta is less than limp home angle

Units: V/

Detail: Proportional gain for the throttle control PID function while **PosSetpoint_ChX** is less than or equal to **LHPsn_Out_ChX** Limp Home position in the Control Calibration Out column.

7 TINeg_ChX



Tip Strip: H-Bridge channel X integral time for PID when Theta is less than limp home angle

Units: s (seconds)

Detail: Specifies Integral time for the throttle control PID function while **PosSetpoint_ChX** is less than **LHPsn_Out_ChX** Limp Home position. The integral time is equivalent to the electro-mechanical time-constant of the throttle body. Smaller integral times intensify the integral action. When TI is set to zero, the integral action is disabled.

8 TDNeg_ChX

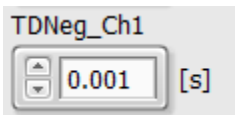

Tip Strip: H-Bridge channel X derivative time for PID when Theta is less than limp home angle

Units: s (seconds)

Detail: Specifies Derivative time for the throttle control PID function while **PosSetpoint_ChX** is less than **LHPsn_Out_ChX** Limp Home position. The derivative time is proportional to the electro-mechanical time-constant of the throttle body. Larger times intensify the derivative action. When TD is set to zero, the derivative action is disabled.

9 LHPsnBand_ChX

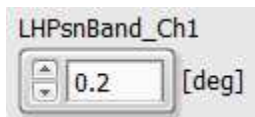

Tip Strip: H-Bridge channel 1 limp home angle error threshold

Units: % or deg

Detail: Limp-home compensation **uLH_ChX** is updated when **PosSetpoint_ChX** is within LH Position Band of **LHPsn_Out_ChX** (above or below).

10 uLH_ChX

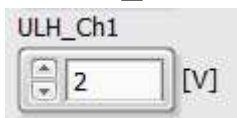

Tip Strip: H-Bridge channel 1 limp home voltage addition

Units: V

Detail: Voltage added or subtracted to the PID output when Position Setpoint is in the vicinity of **LHPsn_Out_ChX**. As Position Setpoint moves through the limp-home region, **uLHc_ChX** is updated to a positive or negative value (negative=closing force, positive=opening force) and added to the PID output in order to assist throttle control through the region.

11 ULHLag_ChX

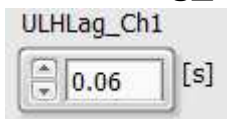

Tip Strip: H-Bridge channel 1 lag filter time applied to limp home compensation

Units: s (seconds)

Detail: Specifies lag filter time applied to the limp-home compensation. A lag time prevents **uLHc_ChX** from reversing directions too fast.

12 US_ChX

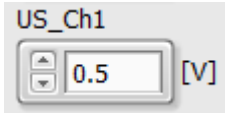

Tip Strip: H-Bridge channel 1 stiction compensation value

Units: V

Detail: Specifies Voltage added to or subtracted from the PID output when Primary Position is outside the vicinity of LH Position. **US_ChX** is intended to compensate for valve stiction. This parameter assists throttle control during small position errors to overcome stiction. Parameter **uFc_ChX** is updated to a positive or negative value according to the sign of Position Setpoint - Primary Position error, and added to the PID output.

13 USLag_ChX

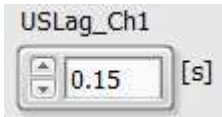

Tip Strip: H-Bridge channel 1 lag filter time for stiction compensaton

Units: s (seconds)

Detail: Specifies lag filter time applied to the stiction compensation. A lag time prevents **uFc_ChX** from reversing directions too fast.

14 LHPsn_ChX

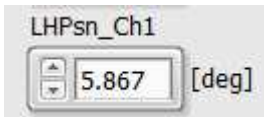

Tip Strip: H-Bridge channel 1 limp home angle

Units: % or deg

Detail: Specifies the default throttle position which results from no power being applied to the motor. If this parameter is not known, it can be set to any value and the Position Calibration process must be executed. The calculated LH Position **LHPsn_Out_ChX** will be updated in the Control Calibration Out column.

15 MotorResistance_ChX



Tip Strip: H-Bridge channel X motor resistance

Units: Ohms

Detail: Specifies the resistance of the motor winding. A digital multi-meter (DMM) can be used to measure this. This value is used to determine safe output ranges.

16 Psn_FaultThresh_ChX

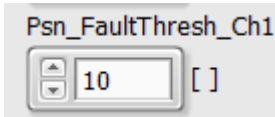

Tip Strip: Sets the max allowable disagreement of the Primary and Secondary Positions.

Detail: If the Secondary Position disagrees with the Primary Position by more than the value set in **Psn_FaultThresh_ChX**, then **Psn_Fault_ChX** will be set to TRUE. Position Fault is not a latching Boolean output. It is continuously updated according to the latest position readings.

Note: If only a single position sensor is used for a throttle body, then this parameter is not applicable.

17 TLead_Out_ChX

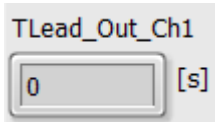

Tip Strip: H-Bridge channel 1 lead compensation time.

Units: s (seconds)

Detail: Indicates the maximum positive voltage applied to the throttle motor upon finding the maximum position sensor signal.

18 TLag_Out_ChX

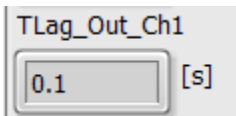

Tip Strip: H-Bridge channel X lag compensation time

Units: s (seconds)

Detail: Adjusts the lag compensation on the **PosSetpoint_ChX** value. A lead/lag compensation function is internally inserted in the **PosSetpoint_ChX** value to the internal PID function.

19 KRPos_Out_ChX

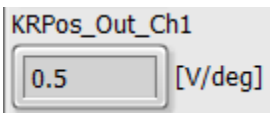

Tip Strip: H-Bridge channel X proportional gain for H-Bridge channel PID when Theta is greater than limp home angle

Units: V/

Detail: Indicates proportional gain for the throttle control PID function while **PosSetpoint_ChX** is greater than **LHPsn_Out_ChX** Limp Home position in the Control Calibration Out column.

20 **TIPos_Out_ChX**

TIPos_Out_Ch1
 [s]

Tip Strip: H-Bridge channel X integral time for PID when Theta is greater than limp home angle

Units: s (seconds)

Detail: Indicates Integral time for the throttle control PID function while **PosSetpoint_ChX** is greater than **LHPsn_Out_ChX** Limp Home position. The integral time is equivalent to the electro-mechanical time-constant of the throttle body. Smaller integral times intensify the integral action. When TI is set to zero, the integral action is disabled.

21 **TDPos_Out_ChX**

TDPos_Out_Ch1
 [s]

Tip Strip: H-Bridge channel X derivative time for PID when Theta is greater than limp home angle

Units: s (seconds)

Detail: Indicates Derivative time for the throttle control PID function while **PosSetpoint_ChX** is greater than **LHPsn_Out_ChX** Limp Home position. The derivative time is proportional to the electro-mechanical time-constant of the throttle body. Larger times intensify the derivative action. When TD is set to zero, the derivative action is disabled.

22 **KRNeg_Out_ChX**

KRNeg_Out_Ch1
 [V]

Tip Strip: H-Bridge channel X proportional gain for H-Bridge channel PID when Theta is less than limp home angle

Units: V/

Detail: Proportional gain for the throttle control PID function while **PosSetpoint_ChX** is less than or equal to **LHPsn_Out_ChX** Limp Home position in the Control Calibration Out column.

23 **TINeg_Out_ChX**

TINeg_Out_Ch1
 [s]

Tip Strip: H-Bridge channel X integral time for PID when Theta is less than limp home angle

Units: s (seconds)

Detail: Indicates Integral time for the throttle control PID function while **PosSetpoint_ChX** is less than **LHPsn_Out_ChX** Limp Home position. The integral time is equivalent to the electro-mechanical time-constant of the throttle body. Smaller integral times intensify the integral action. When TI is set to zero, the integral action is disabled.

24 TDNeg_Out_ChX

TDNeg_Out_Ch1
0.001 [s]

Tip Strip: H-Bridge channel X derivative time for PID when Theta is less than limp home angle

Units: s (seconds)

Detail: Indicates Derivative time for the throttle control PID function while **PosSetpoint_ChX** is less than **LHPsn_Out_ChX** Limp Home position. The derivative time is proportional to the electro-mechanical time-constant of the throttle body. Larger times intensify the derivative action. When TD is set to zero, the derivative action is disabled.

25 LHPsnBand_Out_ChX

LHPsnBand_Out_Ch1
0.2 [deg]

Tip Strip: H-Bridge channel 1 limp home angle error threshold

Units: % or deg

Detail: Limp-home compensation **uLH_ChX** is updated when **PosSetpoint_ChX** is within LH Position Band of **LHPsn_Out_ChX** (above or below).

26 uLH_Out_ChX

ULH_Out_Ch1
2 [V]

Tip Strip: H-Bridge channel 1 limp home voltage addition

Units: V

Detail: Voltage added or subtracted to the PID output when Position Setpoint is in the vicinity of **LHPsn_Out_ChX**. As Position Setpoint moves through the limp-home region, **ULHc_ChX** is updated to a positive or negative value (negative=closing force, positive=opening force) and added to the PID output in order to assist throttle control through the region.

27 ULHLag_Out_ChX

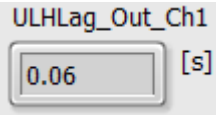

Tip Strip: H-Bridge channel 1 lag filter time applied to limp home compensation

Units: s (seconds)

Detail: Indicates lag filter time applied to the limp-home compensation. A lag time prevents **uLHc_ChX** from reversing directions too fast.

28 US_Out_ChX

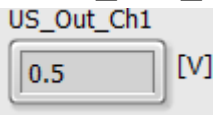

Tip Strip: H-Bridge channel 1 stiction compensation value

Units: V

Detail: Indicates Voltage added to or subtracted from the PID output when Primary Position is outside the vicinity of LH Position. **US_ChX** is intended to compensate for valve stiction. This parameter assists throttle control during small position errors to overcome stiction. Parameter **uFc_ChX** is updated to a positive or negative value according to the sign of Position Setpoint - Primary Position error, and added to the PID output.

29 USLag_Out_ChX

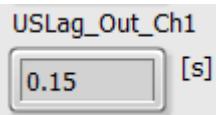

Tip Strip: H-Bridge channel 1 lag filter time for stiction compensaton

Units: s (seconds)

Detail: Indicates lag filter time applied to the stiction compensation. A lag time prevents **uFc_ChX** from reversing directions too fast.

30 LHPsn_Out_ChX

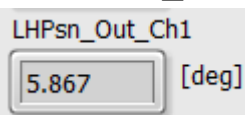

Tip Strip: H-Bridge channel 1 limp home angle

Units: % or deg

Detail: Indicates the default throttle position which results from no power being applied to the motor. If this parameter is not known, it can be set to any value and the Position Calibration process must be executed. The calculated LH Position **LHPsn_Out_ChX** will be updated in the Control Calibration Out column.

31 MotorResistance_Out_ChX

MotorResistance_Out_Ch1
 [Ohms]

Tip Strip: H-Bridge channel X motor resistance

Units: Ohms

Detail: Indicates the resistance of the motor winding. A digital multi-meter (DMM) can be used to measure this. This value is used to determine safe output ranges.

32 Psn_FaultThreshOut_ChX

Psn_FaultThreshOut_Ch1
 []

Tip Strip: Sets the max allowable disagreement of the Primary and Secondary Positions.

Detail: If the Secondary Position disagrees with the Primary Position by more than the value set in **Psn_FaultThresh_ChX**, then **Psn_Fault_ChX** will be set to TRUE. Position Fault is not a latching Boolean output. It is continuously updated according to the latest position readings.

Note: If only a single position sensor is used for a throttle body, then this parameter is not applicable.

4.6 UEGO Setup Window

The purpose of the UEGO Setup window is to configure the operation of the UEGO (O2) sensor module. The DI Driver system supports two Bosch LSU 4.2 or 4.9 wide-band UEGO sensors with fuse-protected heater control circuits and two Narrow-band differential sensor inputs.

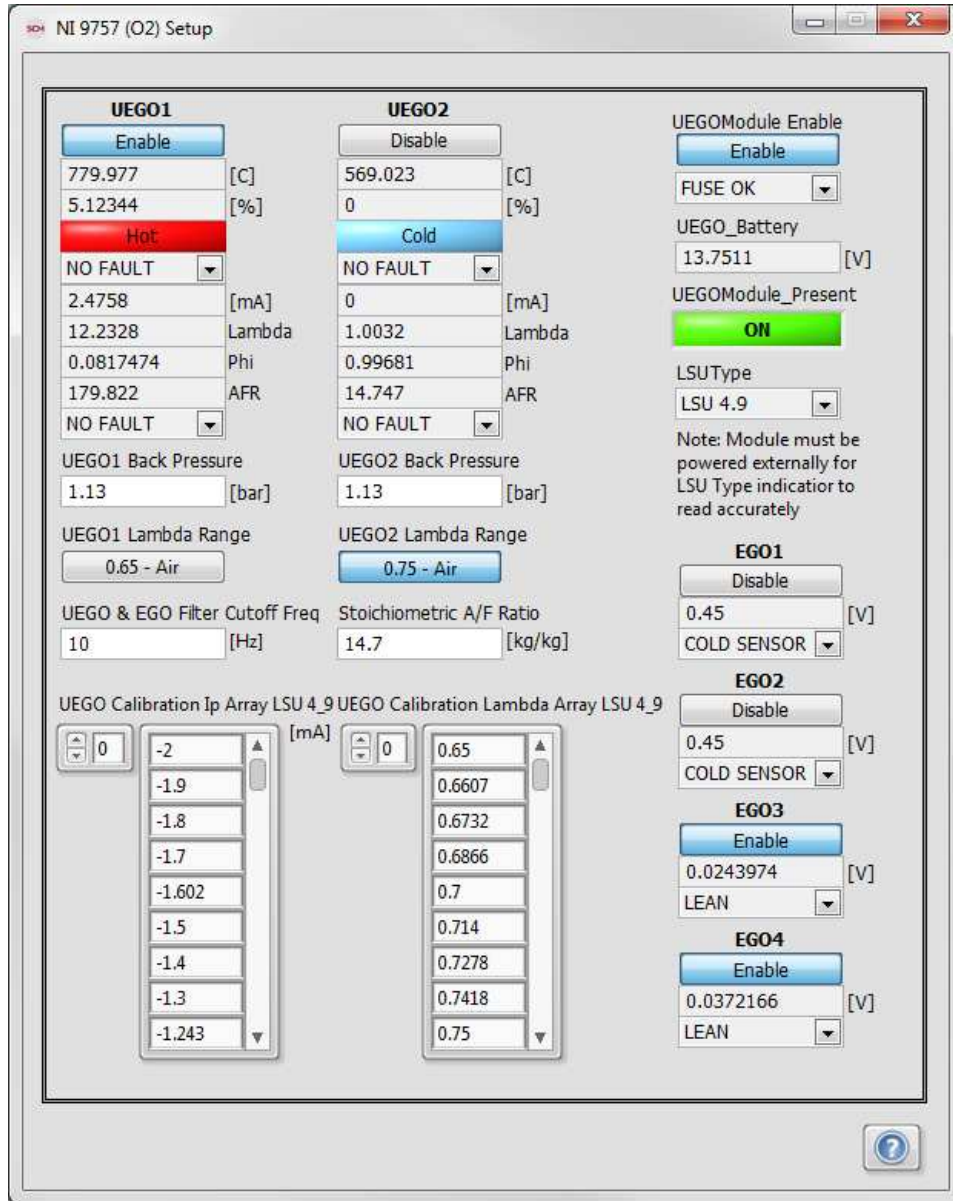

1 UEGOModule Enable

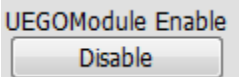

Tip Strip: Specifies Enables O2 sensor module.

Detail: If the O2 sensor module is in the correct slot and UEGOModuleEnable is TRUE, then the RT VI begins initializing the wide-band sensors, bringing them up to temperature, and updating sensor results in the UEGO X cluster.

Warning: If the module is present but no sensors are connected, then the application will time out (30 seconds) with its attempt to bring the sensors up to temperature and discontinue heater control. **UEGOModule Enable** must be set to FALSE and back to TRUE in order to make another attempt at sensor control. It is important that disconnected wide-band sensors are NOT connected while **UEGOModule Enable** is TRUE. It is possible to damage the sensor element of a cold sensor if the sensor connection is made while the UEGOModuleEnable is TRUE and the heater duty cycle is approaching 100%. Sensors should already be connected when **UEGOModule Enable** is set to TRUE so that the temperature is brought up according to a profile specified by Bosch.

2 UEGOModule_Present

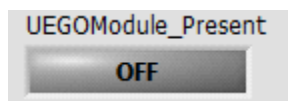

Tip Strip: UEGO Module Present

Detail: Indicates that the module is plugged in to the proper slot, externally powered and recognized by the DI Driver System software. Software may not recognize the module if the software and hardware revisions do not match.

3 Fuse_Status

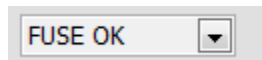

Tip Strip: Fuse status

Detail: A single fuse is located in the module circuit which feeds battery voltage to both sensor heaters.

FUSE OK: The heater circuit fuse is OK.

FUSE BLOWN: The heater circuit fuse is blown.

4 UEGO_Battery

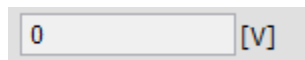

Tip Strip: Module Battery Voltage as read by UEGO module

Units: V

Detail: Indicates battery voltage sensed internal to the module while enabled

UEGOX Cluster

5 UEGOX Enable

Tip Strip: Enable UEGO Channel

Detail: Allows each individual sensor interface to be enabled or disabled.

6 UEGOX_Temp

 [C]

Tip Strip: UEGO Temperature

Units: C

Detail: The controlled temperature, in degrees Celsius, of the wide-band sensor element.

7 UEGOX_Heater_Duty_Cycle

 [%]

Tip Strip: UEGO heater duty cycle

Units: %

Detail: Indicates the heater duty cycle applied to UEGOX channel for debug purposes.

8 UEGOX_Hot

Tip Strip: Sensor Hot Indicator

Detail: The target sensor temperature is 750 degrees Celcius. When TRUE, the wide-band sensor element temperature has entered a controlled temperature range above 730 degrees Celsius and the air/fuel ratio and related values are valid. When FALSE, the air/fuel ratio and related values are not valid. **UEGOX_Hot** will transition from TRUE to FALSE when going below 700 degrees Celsius.

9 UEGOX_Heater_Fault

 ▾

Tip Strip: UEGO heater fault status

Detail: Indicates UEGO Sensor heater fault status

NO FAULT: No faults exist with the sensor heater wires.

SHORT TO GROUND: A short to ground is present on one of the sensor heater wires.

OPEN CIRCUIT: An open circuit is present on one of the sensor heater wires.

SHORT TO BATTERY: A short to battery is present on one of the sensor heater wires.

10 UEGOX_Ip

[mA]

Tip Strip: UEGO Current

Units: mA (milliamps)

Detail: Indicates the pump current required for maintaining a reference voltage of 450 millivolts across the wide-band sensor element. This is also the current required for maintaining a stoichiometric gas mixture within the sensor element.

11 UEGOX_Lambda

Lambda

Tip Strip: Lambda

Detail: The actual air/fuel mass ratio divided by the stoichiometric air/fuel mass ratio. Lambda is equivalent to $1/\Phi$.

12 UEGOX_Phi

Phi

Tip Strip: Reported Equivalence Ratio

Detail: The actual fuel/air mass ratio divided by the stoichiometric fuel/air mass ratio. Phi is equivalent to $1/\text{Lambda}$.

13 UEGOX_AF_Ratio

AFR

Tip Strip: Air Fuel Ratio

Detail: The actual mass air/fuel ratio.

14 UEGOX_Sensor_Fault

Tip Strip: Sensor fault status

Detail: Indicates UEGO Sensor Fault status

NO FAULT: No faults exist with the sensor signal wires.

SHORT TO GND OR BATT: A short to ground or battery is present on one of the sensor signal wires.

15 UEGO Back Pressure

UEGO1 Back Pressure
 [bar]

Tip Strip: Manual Back Pressure

Detail: The air/fuel ratio results are dependent on exhaust system pressure. Many engine systems will have exhaust systems which are very near atmospheric pressure. In this case, this control may be set to a constant value of 1.013 bar. However, if exhaust system pressure is expected to depart from atmospheric pressure at the location of the sensor, then the pressure should be wired to this control.

16 UEGO Lambda Range

UEGO1 Lambda Range

Tip Strip: UEGO Lambda Range

Detail: Adjusts the amplification range for lambda measurement. Two amplification modes are available: One mode, having an amplifier gain factor of 8, allows for measurements of lambda from 0.65 to air. The other mode, having an amplifier gain factor of 17, allows for measurements of lambda = 0.75 to air. It is recommended to use the gain factor of 17 for operation above lambda = 1.5. This gain factor provides better resolution in the lean region. The gain factor can be changed at any time during operation.

17 UEGO & EGO Filter Cutoff Freq

UEGO & EGO Filter Cutoff Freq
 [Hz]

Tip Strip: UEGO and EGO filter cutoff frequency

Units: Hz

Detail: The cutoff frequency for a second-order Butterworth filter applied to all UEGO and EGO channel results.

18 Stoichiometric A/F Ratio

Stoichiometric A/F Ratio
 [kg/kg]

Tip Strip: Stoichiometric A/F Ratio

Units: Kg

Detail: The stoichiometric air-fuel ratio of the calibrated fuel type.

19 UEGO Calibration Ip Array LSU 4.9 (and UEGO Calibration Ip Array LSU 4.2)

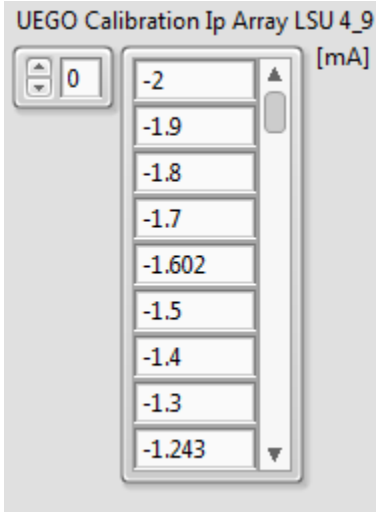

Tip Strip: UEGO Calibration Ip Array LSU 4.9

Detail: The array of pump current values corresponding to Lambda values for a given sensor type and fuel. The entries in the array can be user edited. The default values are valid calibrations for gasoline and diesel fuel. The EDIDS stores calibrations for both the LSU 4.2 and the LSU 4.9 sensor. The calibration displayed in the NI 9757 O2 Module Setup window is determined by the value of the **LSUType** indicator.

20 UEGO Calibration Lambda Array LSU 4.9 (and UEGO Calibration Ip Array LSU 4.2)

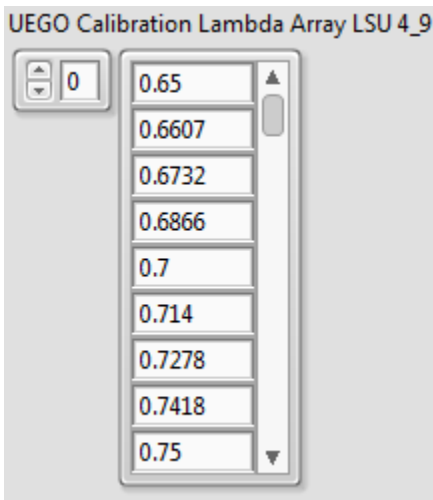

Tip Strip: UEGO Calibration Lambda Array LSU 4.9

Detail: The array of lambda values corresponding to pump values for a given sensor type and fuel. The entries in the array can be user edited. The default values are valid calibrations for gasoline and diesel fuel.

EGOX Cluster

21 EGOX_Enable



Tip Strip: Enables EGO channel

Detail: Allows each individual sensor interface to be enabled or disabled.

22 EGOX_Sensor



Tip Strip: EGO Sensor Voltage

Detail: The voltage being sourced by the EGO sensor.

23 EGOX_Status

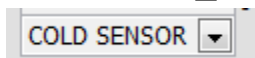

Tip Strip: EGO Sensor Status

Detail: Indicates EGO sensor status

COLD SENSOR: When a narrow-band sensor is cold, the sensor input circuit will report a voltage of approximately 450 millivolts and will not fluctuate with rich and lean exhaust mixtures. This enumeration is reported when the sensor value remains in the range of 400 to 500 millivolts for a period of 1 second.

FOULED SENSOR: When a narrow-band sensor is fouled or aged, the sensor value will transition from rich to lean and from lean to rich much slower than that of a normally operating sensor. This enumeration is reported when the sensor value takes longer than 1 second to transition from below 300 millivolts to above 600 millivolts or vice versa.

RICH: The sensor is sourcing a voltage of greater than 600 millivolts.

LEAN: The sensor is sourcing a voltage of less than 300 millivolts.

4.7 Digital Input Setup Window

The purpose of the Digital Input Setup window is to configure the routing of NI 9411 digital input channels and four internally generated digital PWM signals to various destination functions of the DI Driver System. The window also shows the status of each NI 9411 digital input.

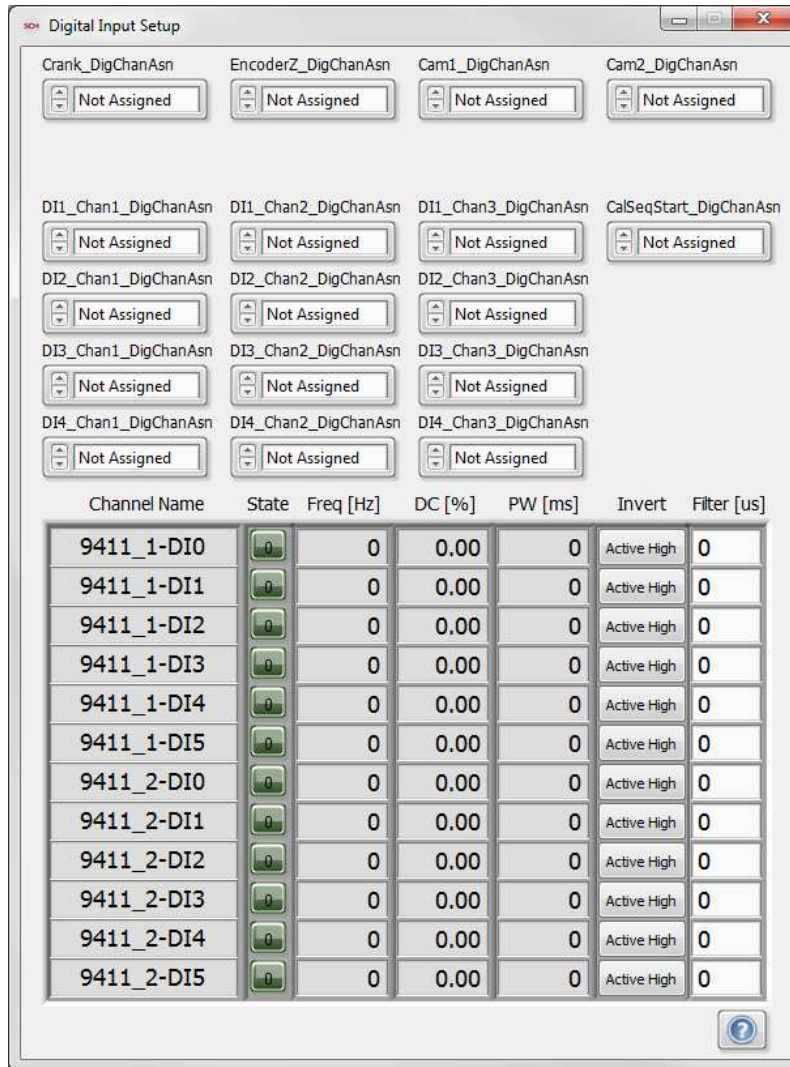

There are twenty destination functions which can be assigned a digital input or internal PWM signal source. There are up to sixteen digital signal sources.

The Crank, Cam, and Encoder destinations are always applicable. The number of applicable DI Driver module channel destinations depends on the number of DI Driver modules available in the system and the slots in which they are inserted. For example, if there are two DI Driver modules inserted in the DI1 and DI2 slots, then only destinations DI1_XXX and DI2_XXX are applicable. If there is only one DI Driver module inserted in the DI4 slot, then only destinations DI4_XXX are applicable.

The number of applicable digital signal sources depends on the NI 9411 digital input modules inserted in the system and the slots in which they are inserted. If there are two NI 9411 modules inserted in the [assigned slots](#), then all twelve digital input sources are available. If there is only one NI 9411 module inserted in the 9411_1 slot, then only

six digital input sources associated with the 9411_1 slot are available. If there is only one NI 9411 module inserted in the 9411_2 slot, then only six digital input sources associated with the 9411_2 slot are available.

There are four internally generated PWM signal sources always available that are configured via the [Auxiliary PWM Setup window](#).

Multiple destination controls that are not on the same row can have the same selected digital signal source. However, controls that are on the same row cannot have the same selected digital signal source. Across a given row, once a digital signal source is selected, it will be grayed out.

Each of the destination controls listed below have a similar drop-down selection of digital signal source and are described below.

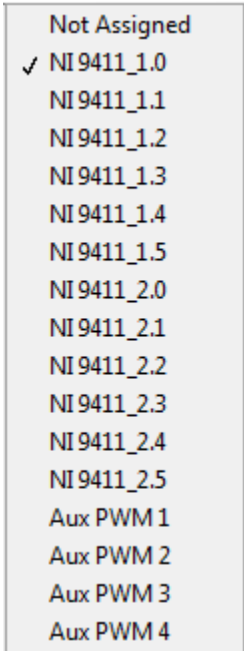

1 Crank_DigChanAsn

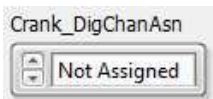

Tip Strip: Assigns digital signal source to crank signal

Detail: Signal directed to the EPT crank trigger input. The EPT is configured via the [Engine Position Tracking Setup](#) window. This signal is applicable for all EPT pattern types. When tracking encoder patterns, assign the high-resolution encoder A signal to the crank signal.

2 EncoderZ_DigChanAsn

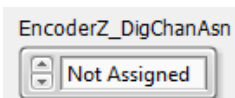

Tip Strip: Assigns digital signal source to encoder Z signal

Detail: Signal directed to the EPT cam trigger input through an optional masking AND gate with either Cam1 or Cam2. The EPT is configured via the [Engine Position Tracking Setup](#) window. This signal is applicable for encoder patterns only. When the encoder is mounted to the crankshaft of a four-stroke engine, then a cam signal must be provided to mask every other encoder Z pulse (FALSE = Mask, TRUE = Pass). When the encoder is mounted to the crankshaft of a two-stroke engine, or the camshaft of a four-stroke engine, then masking may be disabled via the [Engine Position Tracking Setup](#) window [EncZMask](#) control so that every encoder Z pulse passes through to the EPT cam input.

3 CamX_DigChanAsn

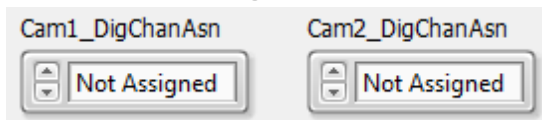

Tip Strip: Assigns digital signal source to cam signal

Detail: There are two available Cam signal destinations named Cam1 and Cam2. Both have similar function. For EPT encoder patterns, one of the Cam signals can be selected, via the [Engine Position Tracking Setup](#) window, as the mask for the encoder Z pulse. For EPT N-M or N+1 patterns, one of the cam signals can be selected as the direct EPT cam trigger input for four-stroke engine phase information. Other functions can be implemented on the Cam signals for capturing the angle of the cam rising edges, configured via the [Cam Phase Capture](#) tab of the [Engine Position Tracking Setup](#) window.



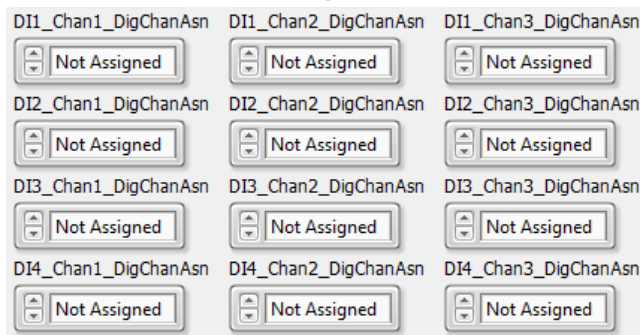









4 DIX_ChanX_DigChanAsn



Tip Strip: Assigns digital signal source to channel during [Direct and TMP Modes](#)

Detail: Up to twelve DI Driver channel destinations are available which will directly command the DI Driver channels from the selected digital signal source. The application of these destinations depends on which DI Driver modules are inserted in the [assigned slots](#). In order to utilize this functionality, the associated DI Driver module must be placed into [Direct Mode](#) or [TMP Mode](#) via the associated [DI Driver Setup](#) window.

5 Digital Input Channel Signals

Channel Name	State	Freq [Hz]	DC [%]	PW [ms]	Invert	Filter [us]
9411_1-DI0		100	50.00	5	Active High	2
9411_1-DI1		0	0.00	0	Active High	0
9411_1-DI2		0	0.00	0	Active High	0
9411_1-DI3		0	0.00	0	Active High	0
9411_1-DI4		0	0.00	0	Active High	0
9411_1-DI5		0	0.00	0	Active High	0
9411_2-DI0		0	0.00	0	Active High	0
9411_2-DI1		0	0.00	0	Active High	0
9411_2-DI2		0	0.00	0	Active High	0
9411_2-DI3		0	0.00	0	Active High	0
9411_2-DI4		0	0.00	0	Active High	0
9411_2-DI5		0	0.00	0	Active High	0

Tip Strip: Digital input channel data and configuration

Units: Frequency: Hz, Duty Cycle: %, Pulse Width: msec, Filter: μ sec

Detail: This display area shows the status of each NI 9411 digital input. The status parameters shown are: **State**, **Frequency**, **Duty Cycle**, and **Pulse Width**. This display area also provides controls for signal inverting and filtering for each input. When the **Invert** button is set to **Active High**, the digital input signal is unaffected. When the **Invert** button is set to **Active Low**, every destination will see the signal as inverted.

4.8 Expansion Digital and VR/Hall Input Setup Window

The purpose of the Expansion Chassis Digital Input Setup window is to configure the routing of 9411 digital input channels, the NI 9760 VR/Hall input channels and four internally generated digital PWM signals to various destination functions on the MXI Expansion Chassis. The window also shows the status of each NI 9411 and VR/Hall inputs.

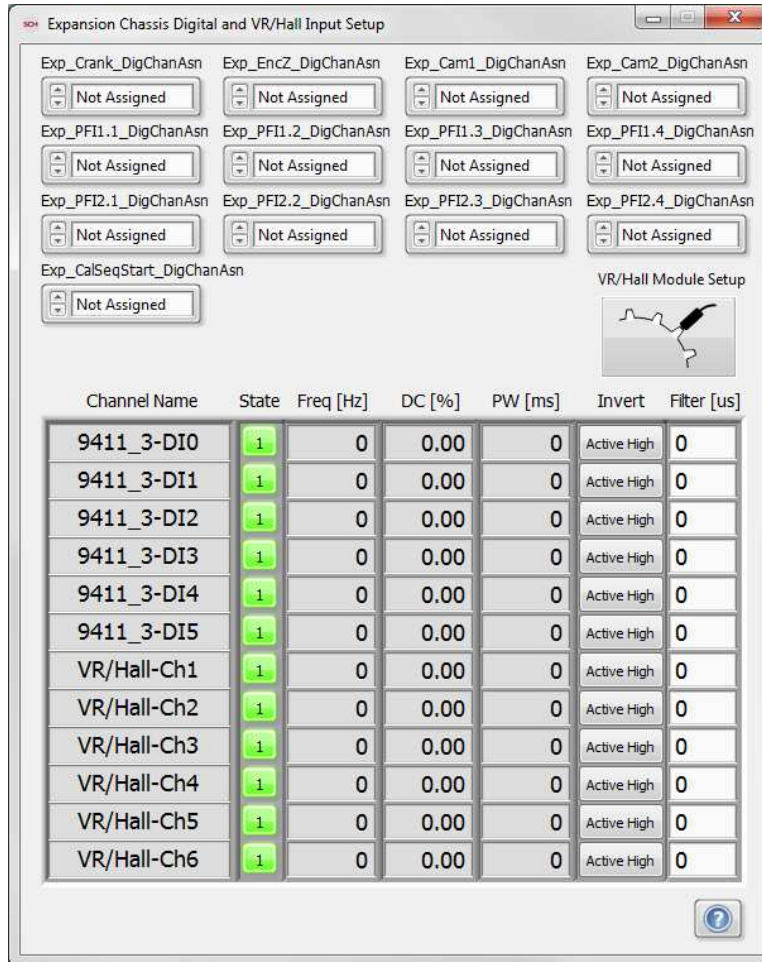

There are thirteen destination functions which can be assigned a digital input, VR/Hall input or an internal PWM signal source. There are up to sixteen digital signal sources.

The Crank, Cam, and Encoder destinations are always applicable. The PFI destinations are only applicable if a PFI Driver module is inserted in its [assigned slot](#).

The number of applicable signal sources depends on the NI 9411 digital input module and NI 9760 VR/Hall module inserted in the system and the slots in which they are inserted. If these modules are inserted in the [assigned slots](#), then all twelve digital input sources are available.

There are four internally generated PWM signal sources always available that are configured via the [Expansion Auxiliary PWM Setup window](#).

Multiple destination controls that are not on the same row can have the same selected digital signal source. However, controls that are on the same row cannot have the same selected digital signal source. Across a given row, once a digital signal source is selected, it will be grayed out.

Each of the destination controls listed below have a similar drop-down selection of digital signal source and are described below.

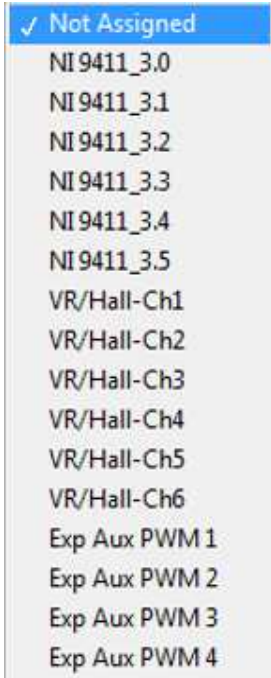

1 Exp_Crank_DigChanAsn

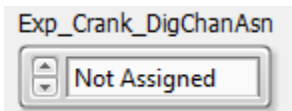

Tip Strip: Assigns digital signal source to crank signal

Detail: Signal directed to the EPT crank trigger input. The EPT is configured via the [Engine Position Tracking Setup](#) window. This signal is applicable for all EPT pattern types. When tracking encoder patterns, assign the high-resolution encoder A signal to the crank signal.

2 Exp_EncZ_DigChanAsn

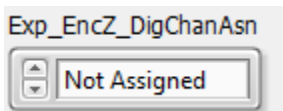

Tip Strip: Assigns digital signal source to encoder Z signal

Detail: Signal directed to the EPT cam trigger input through an optional masking AND gate with either Cam1 or Cam2. The EPT is configured via the [Engine Position Tracking Setup](#) window. This signal is applicable for encoder

patterns only. When the encoder is mounted to the crankshaft of a four-stroke engine, then a cam signal must be provided to mask every other encoder Z pulse (FALSE = Mask, TRUE = Pass). When the encoder is mounted to the crankshaft of a two-stroke engine, or the camshaft of a four-stroke engine, then masking may be disabled via the [Engine Position Tracking Setup](#) window [EncZMask](#) control so that every encoder Z pulse passes through to the EPT cam input.

3 Exp_CamX_DigChanAsn

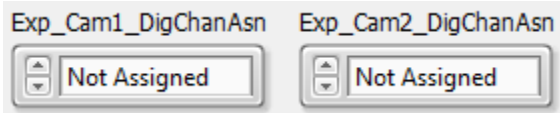

Tip Strip: Assigns digital signal source to cam signal

Detail: There are two available Cam signal destinations named Cam1 and Cam2. Both have similar function. For EPT encoder patterns, one of the Cam signals can be selected, via the [Engine Position Tracking Setup](#) window, as the mask for the encoder Z pulse. For EPT N-M or N+1 patterns, one of the cam signals can be selected as the direct EPT cam trigger input for four-stroke engine phase information. Other functions can be implemented on the Cam signals for capturing the angle of the cam rising edges, configured via the [Cam Phase Capture](#) tab of the [Engine Position Tracking Setup](#) window.

4 Exp_PFIX.Y_DigChanAsn

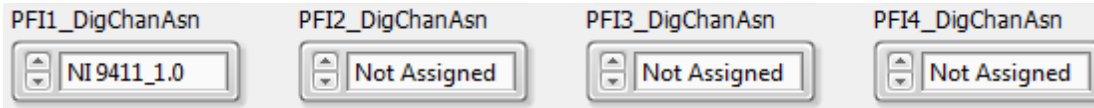

Tip Strip: Assigns digital signal source to channel during Direct and TMP Modes

Detail: Up to eight PFI channel destinations are available which will directly command the PFI channels from the selected digital signal source. These destinations are only available when PFI Driver module(s) are inserted in the [assigned slot](#). In order to utilize this direct command functionality, the PFI Driver module must be placed into [Direct Mode](#) or [TMP Mode](#) via the [PFI X Module Control](#) tab of the [PFI and LS Driver X Setup](#) window.

5 Digital Input Channel Signals

Channel Name	State	Freq [Hz]	DC [%]	PW [ms]	Invert	Filter [us]
9411_3-DI0	1	0	0.00	0	Active High	0
9411_3-DI1	1	0	0.00	0	Active High	0
9411_3-DI2	1	0	0.00	0	Active High	0
9411_3-DI3	1	0	0.00	0	Active High	0
9411_3-DI4	1	0	0.00	0	Active High	0
9411_3-DI5	1	0	0.00	0	Active High	0
VR/Hall-Ch1	1	0	0.00	0	Active High	0
VR/Hall-Ch2	1	0	0.00	0	Active High	0
VR/Hall-Ch3	1	0	0.00	0	Active High	0
VR/Hall-Ch4	1	0	0.00	0	Active High	0
VR/Hall-Ch5	1	0	0.00	0	Active High	0
VR/Hall-Ch6	1	0	0.00	0	Active High	0

Tip Strip: Digital and VR/Hall input channel data and configuration

Units: Frequency: Hz, Duty Cycle: %, Pulse Width: msec, Filter: μ sec

Detail: This display area shows the status of each NI 9411 digital input. The status parameters shown are: **State**, **Frequency**, **Duty Cycle**, and **Pulse Width**. This display area also provides controls for signal inverting and filtering for each input. When the **Invert** button is set to **Active High**, the digital input signal is unaffected. When the **Invert** button is set to **Active Low**, every destination will see the signal as inverted.

6 VR/Hall Module Setup

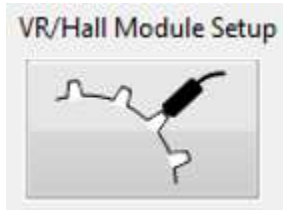

Tip Strip: VR/Hall Module Setup

Detail: Launches the VR/Hall Module Setup Window

4.8.1 VR/Hall Input Setup Window

The purpose of the VR/Hall Input Setup window is to configure the operation of each of the NI 9760 VR/Hall input channels. Each of the six channels can be configured to operate in one of four modes: VR Adaptive Arm (the default mode), VR Manual Arm, Hall, or Hall with Pull-up.

In order to utilize signals generated by VR sensors to enable [EPT Sync](#) on the cRIO-9082 chassis, configure the desired VR/Hall channels on this window and then wire the corresponding output pins on the NI 9760 module to pins on one of the [NI 9411](#) Digital Input modules mounted on the cRIO-9082 chassis to send the signal to that chassis. Without making that additional wiring connection, there is no way to use the NI 9760 to obtain EPT Sync on the cRIO-9082.

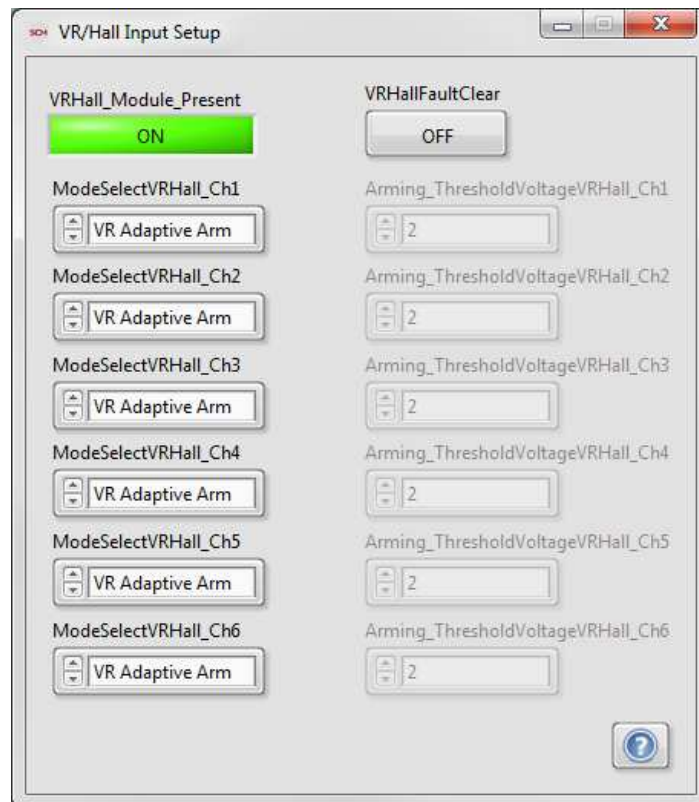

1 VRHall_Module_Present

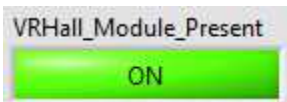

Tip Strip: VR Hall Module Present

Detail: Reports presence of NI 9760 VR/Hall module in chassis.

2 VRHallFaultClear

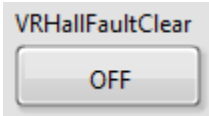

Tip Strip: VR Hall Fault Clear

Detail: Clears a fault condition where an input voltage is too negative to safely engage pull-up resistor on the positive(+) side of input channels.

3 ModeSelectVRHall_ChX

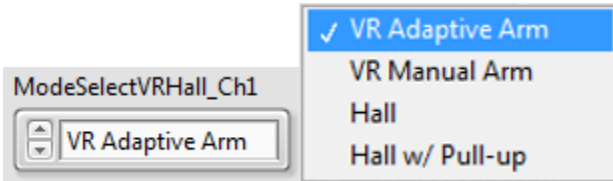

Tip Strip: Mode select for VR/Hall Channel

Detail: Selects the mode of operation for each channel of the NI 9760.

VR Adaptive Arm: Disabled pull-up resistor. Self-adaptive arming threshold for zero-crossing detection.

VR Manual Arm: Disabled pull-up resistor. Manually (or programmatically) set arming threshold for zero-crossing detection.

Hall: Disabled pull-up resistor. Manually (or programmatically) set logic threshold (no zero-crossing detection)

Hall w/ Pull-up: Enabled pull-up resistor. Manually (or programmatically) set logic threshold (no zero-crossing detection)

See hardware manual for a more detailed description of each arming threshold mode.

4 Arming_ThresholdVoltageVRHall_ChX

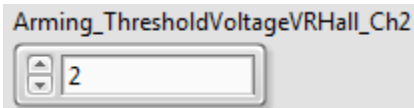

Tip Strip: Assigns digital signal source to channel during Direct and TMP Modes

Detail: Arming (VR) or logic (Hall) threshold voltages used in 'VR Manual Arm' or Hall modes of operation. Min=0V, Max=2.97V.

4.9 Analog Input Setup Window

The purpose of the Analog Input Setup window is to configure input processing of the analog signals to the NI 9220 Analog Input module. The window has sixteen tabs. Each tab is associated with one channel of the NI 9220 and provides signal identification, monitoring, filtering, and conversion to engineering units.

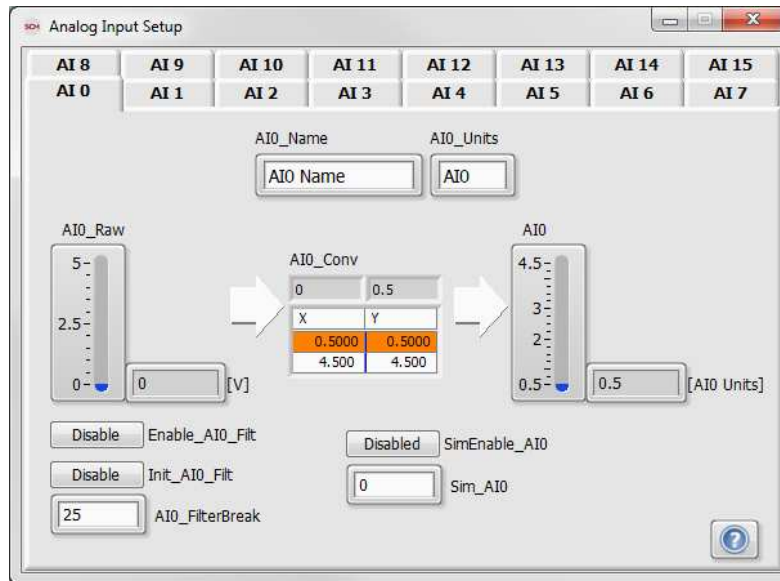

1 AIX_Name

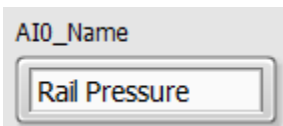

Tip Strip: Text name
Detail: Name assigned to each analog input.

2 AIX_Units

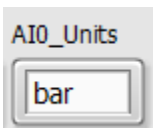

Tip Strip: Text units
Detail: Units assigned to each analog input.

3 AIX_Raw

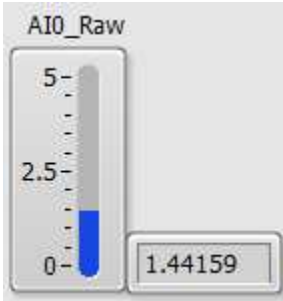

Tip Strip: Raw voltage input

Units: V

Detail: Raw voltage signal sensed by the NI 9220 module.

4 AIX_Conv

AIO_Conv	
0.014287!	0
X	Y
0.5000	0.000
4.500	1800

Tip Strip: Calibration table

Detail: 1D Lookup table for converting the analog input to engineering units. It is assumed that the conversion is linear and the table is 2x2. The X values correspond to the [AIX_Raw](#) (V) while the Y values correspond to the engineering parameter [AIX](#) (u), such as Rail Pressure (bar).

5 AIX

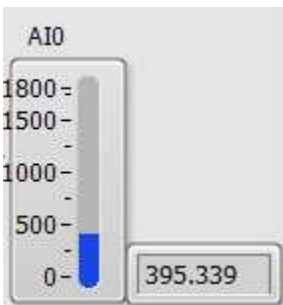

Tip Strip: Output from calibration table

Units: Same as [AIX_Units](#)

Detail: Engineering parameter such as Rail Pressure (bar) which is interpolated by the [AIX_Conv](#) 1D Table. The unit (u) indicates the units specified in [AIX_Units](#).

6 Enable_AIX_Filt

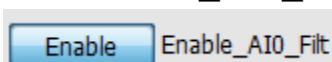

Tip Strip: Enable use of filter

Detail: Enable filtering of the incoming voltage signal read by the 9220 module.

7 Init_AIX_Filt

Tip Strip: Re-initialize filter to change break frequency

Detail: When pressed, reinitializes the 2nd order filter on [AIX_Raw](#). The filter should be reinitialized when changing [AIX_FilterBreak](#).

8 AIX_FilterBreak

Tip Strip: Filter cutoff frequency

Units: Hz

Detail: Lowpass cutoff frequency of a 2nd order filter on raw voltage.

9 SimEnable_AIX

Tip Strip: Enable simulation of this parameter in engineering units

Detail: When TRUE, passes the [Sim_AIX](#) directly to [AIX](#), bypassing the filter and conversion lookup table. This is useful for tuning PID control gains when [AIX](#) is being used for feedback control.

10 Sim_AIX

Tip Strip: Simulation value

Units: Same as [AIX_Units](#)

Detail: The value, in engineering units, that is simulated when [SimEnable_AIX](#) is **ENABLED**.

4.10 Pulse Generation Setup Window

The purpose of the Pulse Generation Setup window is to configure injection command pulse sequences for the DI Driver modules and the PFI Driver modules when configured for [EPT](#) or [TMP](#) operating modes. The operating mode of each module is configured via its associated module setup window. This window is not applicable for modules which are configured for [Direct Mode](#).

4.10.1 DI-TMP Tab

The DI-TMP tab is for configuring Triggered Multi-Pulse (TMP) injection command pulse sequences with up to 6 pulses per sequence. Below is a timing diagram showing the effect of each parameter. An independent TMP command sequence is provided for each DI Driver module. The TMP command sequence associated with a DI Driver module can be configured to apply to all channels of that module or each channel can be configured to have its own sequence. The configured TMP command sequence can be triggered to a specific channel via a button associated with each channel of each DI Driver module.

DI-TMP	DI-EPT						PFI			PFI 2
	Pulse 1	Pulse 2	Pulse 3	Pulse 4	Pulse 5	Pulse 6				
DI Driver 1	ON	ON	ON	OFF	OFF	OFF	TMP-OneShot_DI1_Chn1		Enable Individual DI1 Channel Duration	
Delay (msec)	0	4	2	1	1	1	TMP-OneShot_DI1_Chn2			
Uniform Dur. (msec)	0.5	1.5	0.5	0	0	0	TMP-OneShot_DI1_Chn3			
Duration Ch2 (msec)	0.5	1.5	0.5	0	0	0				
Duration Ch3 (msec)	0.5	1.5	0.5	0	0	0				
DI Driver 2	ON	ON	ON	OFF	OFF	OFF	TMP-OneShot_DI2_Chn1		Enable Individual DI2 Channel Duration	
Delay (msec)	0	4	2	1	1	1	TMP-OneShot_DI2_Chn2			
Duration Ch1 (msec)	0.5	1.5	0.5	0	0	0	TMP-OneShot_DI2_Chn3			
Duration Ch2 (msec)	0.6	1.4	0.65	0	0	0				
Duration Ch3 (msec)	0.55	1.53	0.58	0	0	0				
DI Driver 3	ON	ON	ON	OFF	OFF	OFF	TMP-OneShot_DI3_Chn1		Enable Individual DI3 Channel Duration	
Delay (msec)	0	4	2	1	1	1	TMP-OneShot_DI3_Chn2			
Uniform Dur. (msec)	0.5	1.5	0.5	0	0	0	TMP-OneShot_DI3_Chn3			
Duration Ch2 (msec)	0	0	0	0	0	0				
Duration Ch3 (msec)	0	0	0	0	0	0				
DI Driver 4	ON	ON	ON	OFF	OFF	OFF	TMP-OneShot_DI4_Chn1		Enable Individual DI4 Channel Duration	
Delay (msec)	0	4	2	1	1	1	TMP-OneShot_DI4_Chn2			
Uniform Dur. (msec)	0.5	1.5	0.5	0	0	0	TMP-OneShot_DI4_Chn3			
Duration Ch2 (msec)	0	0	0	0	0	0				
Duration Ch3 (msec)	0	0	0	0	0	0				

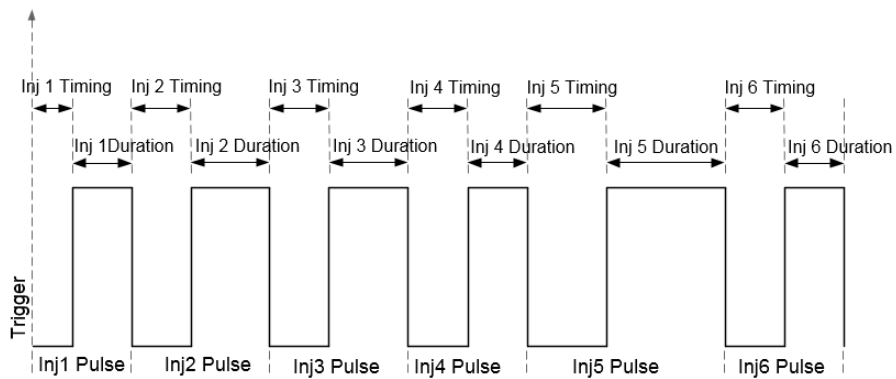

Figure 4.10.1.a. Pulse Train illustration for TMP, TMP OneShot and PID/PWM-TMP Mode

1 TMP-OneShot_DIX_ChnX



Tip Strip: Manually triggers TMP injection command sequence

Detail: Pressing this button will trigger the configured TMP command sequence to the associated DI Driver module channel. The sequence will be triggered once with each button press.

2 Enable Individual DIX Channel Duration



Tip Strip: Enables individual channel duration setpoint for each channel

Detail: When **ON**, this button will enable individual channel durations for each of the three DI Driver module channels. When **OFF**, each channel receives a uniform duration command.

3 Pulse



Tip Strip: Enables injection pulse

Detail: When **ON**, the command to the associated DI Driver module channel will be active for the specified duration. When **OFF**, the command will be inactive (low), but the specified delay and duration will still be implemented without affecting the adjacent pulses.

4 Delay

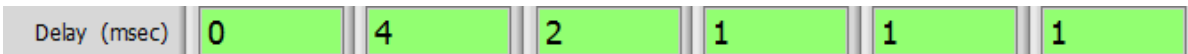

Tip Strip: Time until beginning of this injection pulse

Units: msec

Detail: For Inj 1, specifies the delay of the start of Inj 1 from the trigger event. For all other pulses, specifies the delay of the start of Inj X from the end of the previous pulse.

5 Uniform Duration/Ch1 Duration

Uniform Dur. (msec)	0.5	1.5	0.5	0	0	0
---------------------	-----	-----	-----	---	---	---

Tip Strip: Duration of injection pulse

Units: msec

Detail: Specifies the time duration of the injection pulse. The **ON/OFF** button above the [Delay](#) and [Duration](#) parameters determines whether the pulse will be active or inactive. The control sends commands to Ch 1 if the [Enable Individual DIX Channel Duration](#) parameter is enabled and to all three channels if the parameter is disabled.

6 Ch2 Duration

Duration Ch2 (msec)	0.5	1.5	0.5	0	0	0
---------------------	-----	-----	-----	---	---	---

Tip Strip: Duration of injection pulse

Units: msec

Detail: Specifies the time duration of the injection pulse. The **ON/OFF** button above the [Delay](#) and [Duration](#) parameters determines whether the pulse will be active or inactive. The control sends commands to Ch 2 if the [Enable Individual DIX Channel Duration](#) parameter is enabled and is not active if the parameter is disabled.

7 Ch3 Duration

Duration Ch3 (msec)	0.5	1.5	0.5	0	0	0
---------------------	-----	-----	-----	---	---	---

Tip Strip: Duration of injection pulse

Units: msec

Detail: Specifies the time duration of the injection pulse. The **ON/OFF** button above the [Delay](#) and [Duration](#) parameters determines whether the pulse will be active or inactive. The control sends commands to Ch 3 if the [Enable Individual DIX Channel Duration](#) parameter is enabled and is not active if the parameter is disabled.

8 Direct Injector Driver Modules 2-4

DI Driver 2	ON	ON	ON	OFF	OFF	OFF	TMP-OneShot_DI2_Chn1	Enable Individual DI2 Channel Duration
Delay (msec)	0	4	2	1	1	1	TMP-OneShot_DI2_Chn2	
Duration Ch1 (msec)	0.5	1.5	0.5	0	0	0	TMP-OneShot_DI2_Chn3	
Duration Ch2 (msec)	0.6	1.4	0.65	0	0	0		
Duration Ch3 (msec)	0.55	1.53	0.58	0	0	0		
DI Driver 3	ON	ON	ON	OFF	OFF	OFF	TMP-OneShot_DI3_Chn1	Enable Individual DI3 Channel Duration
Delay (msec)	0	4	2	1	1	1	TMP-OneShot_DI3_Chn2	
Uniform Dur. (msec)	0.5	1.5	0.5	0	0	0	TMP-OneShot_DI3_Chn3	
Duration Ch2 (msec)	0	0	0	0	0	0		
Duration Ch3 (msec)	0	0	0	0	0	0		
DI Driver 4	ON	ON	ON	OFF	OFF	OFF	TMP-OneShot_DI4_Chn1	Enable Individual DI4 Channel Duration
Delay (msec)	0	4	2	1	1	1	TMP-OneShot_DI4_Chn2	
Uniform Dur. (msec)	0.5	1.5	0.5	0	0	0	TMP-OneShot_DI4_Chn3	
Duration Ch2 (msec)	0	0	0	0	0	0		
Duration Ch3 (msec)	0	0	0	0	0	0		

Detail: Please see information for DI Driver 1

4.10.2 DI-EPT Tab

The DI-EPT tab is for configuring EPT injection command pulse sequences with up to 6 pulses per sequence. Figures 4.10.2.a and 4.10.2.b, below, are timing diagrams showing the effect of each [DIX Timing Mode](#) parameter. An independent EPT command sequence is provided for each DI Driver module. The EPT command sequence associated with a DI Driver module can be configured to apply to all channels of that module, or it can be configured so that each individual channel receives different injection durations. Each command pulse sequence can be independently configured to operate in [Start of Injection \(SOI\) mode](#) or [End of Injection \(EOI\) mode](#) according to a specified angle with respect to the channel's Top Dead Center (TDC) reference. Some parameters are disabled according to the selected [DIX Timing Mode](#). The disabled parameters will retain their most recently entered value and will not accept a value from the keyboard.

The DI module can also operate in a Skip Fire mode, wherein the user specifies a Skip Fire Sequence according to the total number of cycles desired in the sequence, [SkipFire_Cycles](#), and the number of active cycles in which an injection occurs, [SkipFire_OnCycle](#). Only one Skip Fire Sequence can be defined for the entire DI Driver System, but it can be enabled on all present channels.

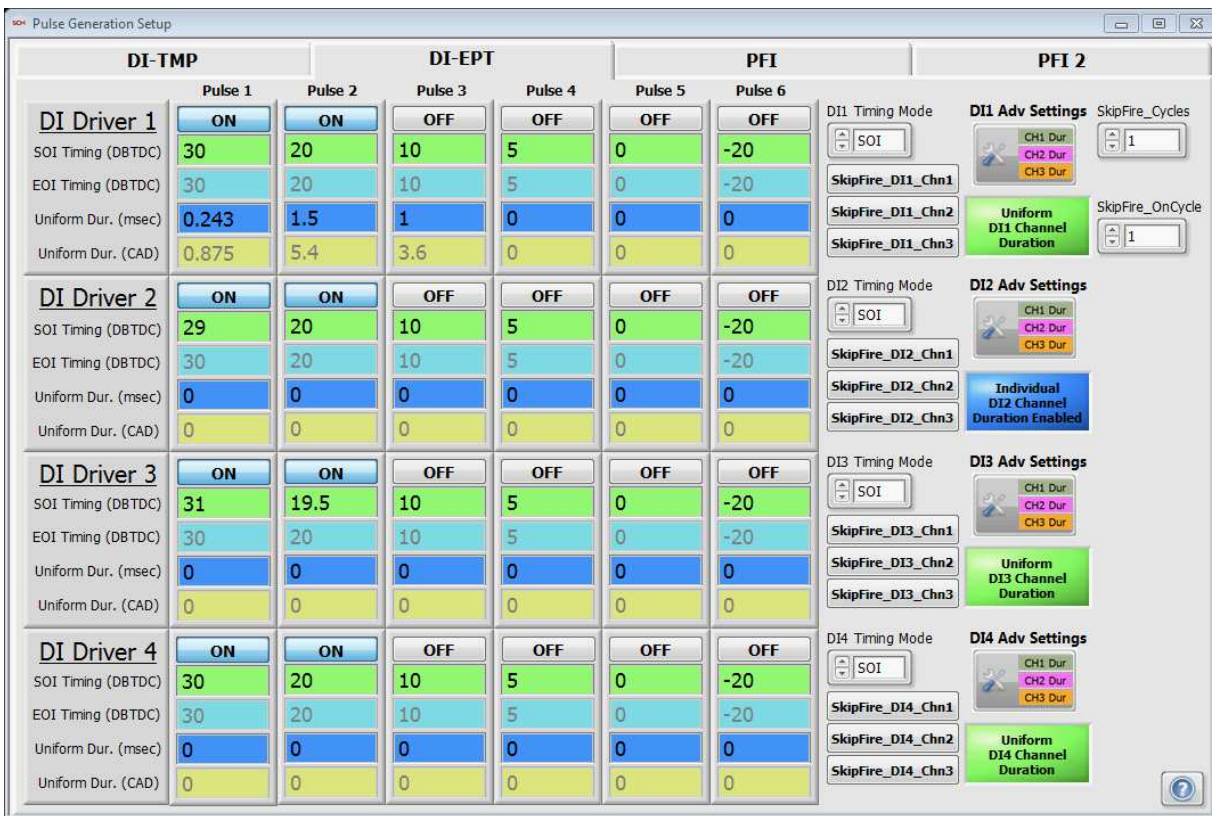

1 Pulse



Tip Strip: Enables injection pulse

Detail: When **ON**, the command to the associated DI Driver module channel will be active for the specified duration. When **OFF**, the command will not be implemented. The timing of the adjacent pulses will remain the same whether the pulse is **ON** or **OFF**.

2 SOI Timing

SOI Timing (DBTDC)	30	20	10	5	0	-20
--------------------	----	----	----	---	---	-----

Tip Strip: Start Of Injection angle with respect to TDC

Units: DBTDC

Detail: When [DIX Timing Mode](#) is set to **SOI**, this parameter specifies the Start of Injection (SOI) timing in Degrees before TDC. When [DIX Timing Mode](#) is set to **EOI**, this parameter is disabled and retains its most recent value.

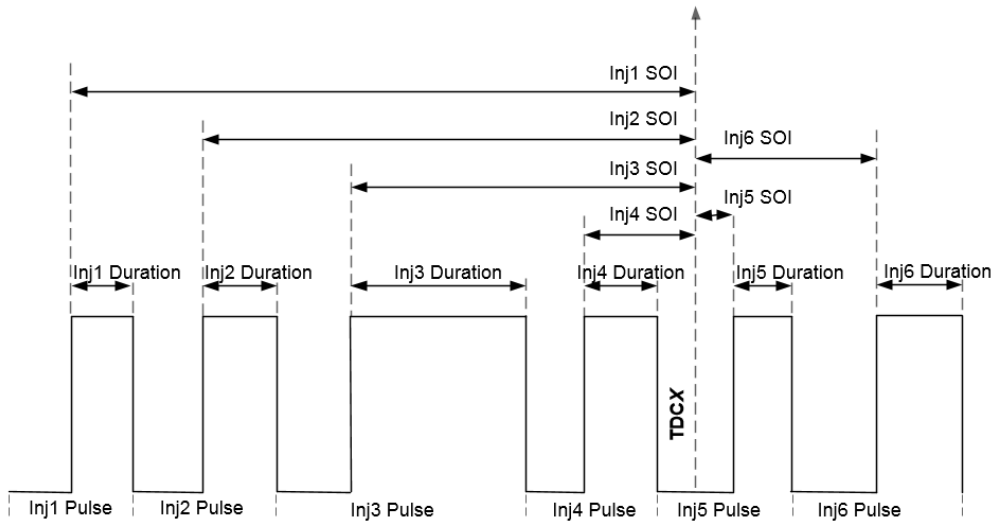

Figure 4.10.2.a, Pulse Train for SOI Timing Mode. The reference timing is TDC position for each individual cylinder. Applicable to EPT mode.

3 Duration

Uniform Dur. (msec)	0.243	1.5	1	0	0	0
---------------------	-------	-----	---	---	---	---

Tip Strip: Duration of injection pulse

Units: msec

Detail: Specifies the time duration of the injection pulse. The **ON/OFF** button above each [Timing](#) and [Duration](#) parameter determines whether the pulse will be active or inactive.

4 EOI Timing

EOI Timing (DBTDC)	29	20	10	5	0	-20
--------------------	----	----	----	---	---	-----

Tip Strip: End Of Injection angle with respect to TDC

Units: DBTDC

Detail: When [DIX Timing Mode](#) is set to **EOI**, this parameter specifies the End of Injection (EOI) timing in Degrees before TDC. When [DIX Timing Mode](#) is set to **SOI**, this parameter is disabled and retains its most recent value.

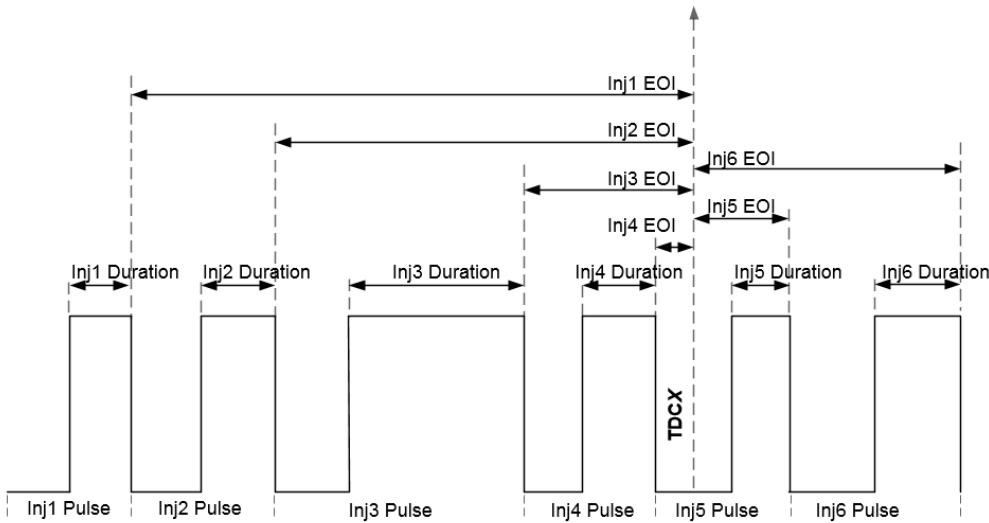

Figure 4.10.2.b, Pulse Train for EOI Timing Mode. The reference timing is TDC position for each individual cylinder. Applicable to EPT mode.

5 Duration

Uniform Dur. (CAD)	0.729	4.5	3	0	0	0
--------------------	-------	-----	---	---	---	---

Tip Strip: Duration of injection pulse

Units: CAD

Detail: This parameter is always disabled, but automatically updated with a calculated value. It is calculated based on [Duration](#) (msec) and [engine speed](#) shown in the [EPT](#) Tab of the [Engine Position Tracking Setup](#) window.

6 DIX Timing Mode

DI1 Timing Mode

- EOI
- SOI

Tip Strip: Selects timing mode of each injection pulse as Start Of Injection or End Of Injection

Detail: Selector for choosing between Start of Injection “SOI” Mode and End of Injection “EOI” Mode. When **SOI** mode is selected, the **EOI** Timing parameters will be disabled and retain their most recently entered end of injection angle. When **EOI** mode is selected, the **SOI** Timing parameters will be disabled and retain their most recently entered start of injection angle.

7 DIX Adv Settings

DI1 Adv Settings

- CH1 Dur
- CH2 Dur
- CH3 Dur

Tip Strip: Press this button to define duration for each Driver channel.

Detail: Pressing this button launches the [DI1 Advanced Configuration](#) control window. The DI1 Advanced Configuration window allows a user to program individual injection pulse durations for each pulse in an injection sequence.

8 Uniform/Individual DIX Channel Duration Enabled Indicator



Tip Strip: Defines whether the DI Driver module is in uniform channel duration or individual channel duration mode.
Detail: Shows the state of the [Enable Individual DIX Channel Duration](#) control in the corresponding [DIX Advance Settings](#) window. When the control is disabled, the indicator appears green and says the channels all have uniform duration, as pictured above. When enabled, the indicator appears blue and says the channels have individual durations enabled, as pictured on Channel 2 in the window shown at the beginning of [DI-EPT Tab](#).

9 SkipFire_DI1_ChX

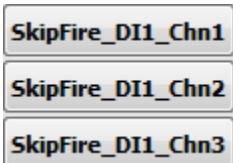

Tip Strip: Enables Skip Fire on DI channel when EPT Mode is selected
Detail: Enables the skip fire sequence defined by [SkipFire_Cycles](#) and [SkipFire_OnCycle](#) for their assigned DI channels. It also manipulates the corresponding [SkipFire_DI1_ChnX](#) buttons in the [DI1 Adv Settings Window](#).

10 SkipFire_Cycles

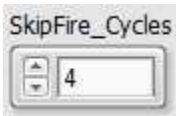

Tip Strip: Specifies the period length, in number of cycles, for the Skip Fire Sequence in EPT Mode (Min = 1).
Detail: Specifies the number of cycles included in a Skip Fire Sequence when the DI injector is operated in EPT mode. For example, if the number 7 is entered, the DI injector will continuously repeat a seven cycle sequence as long as [SkipFire_DI1_ChnX](#) is enabled for the desired channel. It is also manipulated by the corresponding [SkipFire_Cycles](#) control in all the [DIX Advanced Settings](#) windows.

11 SkipFire_OnCycle

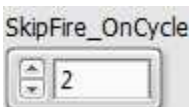

Tip Strip: Specifies the number of active cycles during Skip Fire Sequence in EPT Mode (Min = 1).
Detail: Specifies the number of active cycles included in a Skip Fire Sequence when the DI injector is operated in EPT mode. For example, if the number 4 is entered and [DI SkipFire_Cycles](#) is set to 7, the DI injector will continuously repeat a seven cycle sequence with four active cycles, followed by three inactive cycles as

long as [SkipFire_DI1_ChnX](#) is enabled for the desired channel. It is also manipulated by the corresponding [SkipFire_OnCycle](#) control in all the [DIX Advanced Settings](#) windows.

12 DI Drivers 2-4

DI Driver 2	OFF	OFF	OFF	OFF	OFF	OFF
SOI Timing (DBTDC)	30	20	10	5	0	-20
EOI Timing (DBTDC)	29	20	10	5	0	-20
Uniform Dur. (msec)	2	0	0	0	0	0
Uniform Dur. (CAD)	6	0	0	0	0	0

DI Driver 3	ON	OFF	OFF	OFF	OFF	OFF
SOI Timing (DBTDC)	31	19.5	10	5	0	-20
EOI Timing (DBTDC)	30	20	10	5	0	-20
Uniform Dur. (msec)	0.45	0.56	1.09	0	0	0
Uniform Dur. (CAD)	1.35	1.68	3.27	0	0	0

DI Driver 4	OFF	OFF	OFF	OFF	OFF	OFF
SOI Timing (DBTDC)	30	20	10	5	0	-20
EOI Timing (DBTDC)	30	20	10	5	0	-20
Uniform Dur. (msec)	0	0	0	0	0	0
Uniform Dur. (CAD)	0	0	0	0	0	0

DI2 Timing Mode
EOI

SkipFire_DI2_Chn1
SkipFire_DI2_Chn2
SkipFire_DI2_Chn3

DI2 Adv Settings

CH Dur: CH Dur: CH Dur:

Individual DI2 Channel Duration Enabled

DI3 Timing Mode
SOI

SkipFire_DI3_Chn1
SkipFire_DI3_Chn2
SkipFire_DI3_Chn3

DI3 Adv Settings

CH Dur: CH Dur: CH Dur:

Uniform DI3 Channel Duration

DI4 Timing Mode
SOI

SkipFire_DI4_Chn1
SkipFire_DI4_Chn2
SkipFire_DI4_Chn3

DI4 Adv Settings

CH Dur: CH Dur: CH Dur:

Uniform DI4 Channel Duration

Detail: Please see information for DI Driver 1

4.10.2.1 DI Advanced Settings Window

The DI1 Advanced Settings Window allows users to configure individual channel durations for DI EPT injection command pulse sequences. The pulse enable and timing controls can be configured from this window, but they apply to all channels of the DI Driver module. Similar to the [DI-EPT Tab](#), Figures [4.10.2.1.a](#) and [4.10.2.1.b](#), below, are timing diagrams showing the effect of each [DIX Timing Mode](#) parameter. An independent EPT injection duration command sequence is provided for each DI Driver channel. The command pulse sequence can be configured to operate in [Start of Injection \(SOI\) mode](#) or [End of Injection \(EOI\) mode](#) according to a specified angle with respect to the channel's Top Dead Center (TDC) reference. Some parameters are disabled according to the selected [DIX Timing Mode](#); the disabled parameters will retain their most recent value and will not accept a value from the keyboard.

The DI module can also be operated in a Skip Fire mode, wherein the user specifies a Skip Fire Sequence according to the total number of cycles desired in the sequence, [SkipFire_Cycles](#), and the number of active cycles on which an injection occurs, [SkipFire_OnCycle](#). Only one Skip Fire Sequence can be defined for the entire DI Driver System, but it can be enabled on all present channels. Changing [SkipFire_Cycles](#) or [SkipFire_OnCycle](#) from this window programmatically changes the value of that parameter on the [DI-EPT Tab](#) and all other [DIX Advanced Settings](#) windows. Similarly, changing the value of each [SkipFire_DI1_ChnX](#) parameter programmatically updates the value of the corresponding parameters on the DI-EPT Tab.



1 Pulse



Tip Strip: Enables injection pulse

Detail: When **ON**, the command to the associated DI Driver module channel will be active for the specified duration. When **OFF**, the command will be inactive. These controls also manipulate the corresponding Pulse # controls on the main [DI-EPT Tab](#).

2 SOI Timing

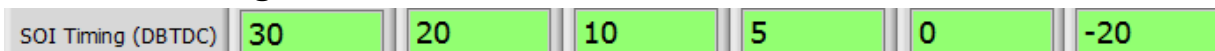

Tip Strip: Start Of Injection angle with respect to TDC
Units: DBTDC

Detail: When [DIX Timing Mode](#) is set to **SOI**, this parameter specifies the Start of Injection (SOI) timing in Degrees before TDC. When [DIX Timing Mode](#) is set to **EOI**, this parameter is disabled and retains its most recent value.

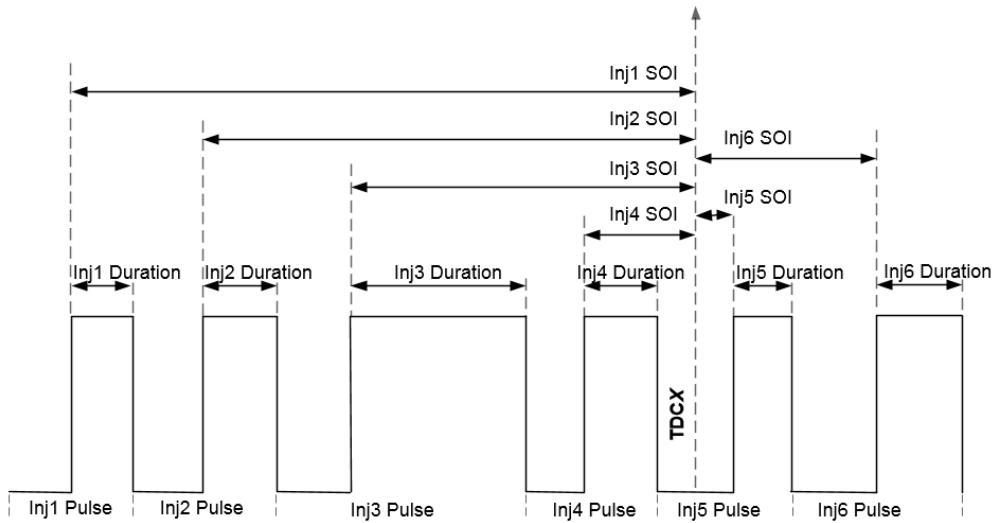

Figure 4.10.2.1.a, Pulse Train for SOI Timing Mode. The reference timing is TDC position for each individual cylinder. Applicable to EPT mode.

3 EOI Timing

EOI Timing (DBTDC)	30	20	10	5	0	-20
--------------------	----	----	----	---	---	-----

Tip Strip: End Of Injection angle with respect to TDC

Units: DBTDC

Detail: When [DIX Timing Mode](#) is set to **EOI**, this parameter specifies the End of Injection (EOI) timing in Degrees before TDC. When [DIX Timing Mode](#) is set to **SOI**, this parameter is disabled and retains its most recent value.

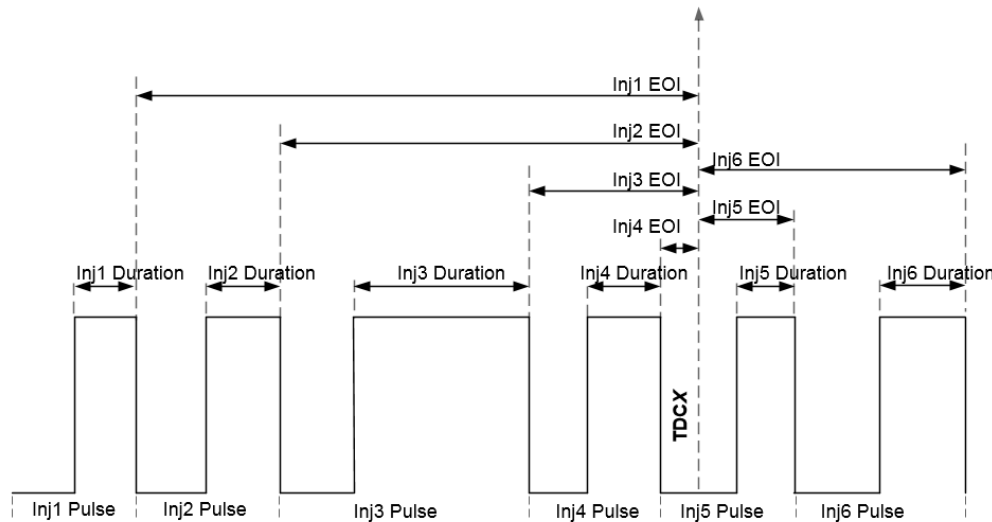

Figure 4.10.2.1.b, Pulse Train for EOI Timing Mode. The reference timing is TDC position for each individual cylinder. Applicable to EPT mode.

4 Duration Ch1 (msec)

Duration Ch1 (msec)	0.5	0.18	2.5	0	0	0
---------------------	-----	------	-----	---	---	---

Tip Strip: Duration of injection pulse

Units: msec

Detail: Specifies the time duration of the injection pulse. The **ON/OFF** button above each [Timing](#) and [Duration](#) parameter determines whether the pulse will be active or inactive.

5 Duration Ch1 (CAD)

Duration Ch1 (CAD)	3.6	1.296	18	0	0	0
--------------------	-----	-------	----	---	---	---

Tip Strip: Duration of injection pulse

Units: CAD

Detail: This parameter is always disabled, but automatically updated with a calculated value. It is calculated based on [Duration](#) (msec) and [engine speed](#) shown in the [EPT](#) Tab of the [Engine Position Tracking Setup](#) window.

6 DIX Timing Mode

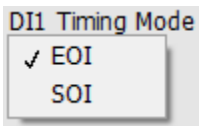

Tip Strip: Selects timing mode of each injection pulse as Start Of Injection or End Of Injection

Detail: Selector for choosing between Start of Injection “SOI” Mode and End of Injection “EOI” Mode. When **SOI** mode is selected, the **EOI** Timing parameters will be disabled and retain their most recently entered end of injection angle. When **EOI** mode is selected, the **SOI** Timing parameters will be disabled and retain their most recently entered start of injection angle.

7 Enable Individual DI1 Channel Duration

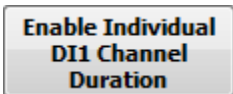

Tip Strip: Defines whether the DI Driver module is in uniform or individual mode.

Detail: Activates the individual channel duration controls shown on this screen and also controls the [Uniform/Individual Channel Duration Indicator](#) on the [DI-EPT Pulse Generation Tab](#).

8 Duration Ch2 and Ch3

Duration Ch2 (msec)	0.8	0.2	2.4	0	0	0
Duration Ch2 (CAD)	5.76	1.44	17.28	0	0	0
Duration Ch3 (msec)	0.9	0.15	2.6	0	0	0
Duration Ch3 (CAD)	6.48	1.08	18.72	0	0	0

Detail: Please see information for channel 1

9 Average Duration

Avg Duration (msec)	0.733	0.177	2.5	0	0	0
Avg Duration (CAD)	5.28	1.272	.18	0	0	0

Detail: Displays the average duration of the injection commands for all three channels.

10 SkipFire_DI1_ChnX



Tip Strip: Enables Skip Fire on DI channel when EPT Mode is selected

Detail: Enables the skip fire sequence defined by [SkipFire_Cycles](#) and [SkipFire_OnCycle](#) for their assigned DI channels. It is also manipulated by the corresponding [SkipFire_DI1_ChnX](#) buttons on the [DI-EPT Pulse Generation Tab](#).

11 SkipFire_Cycles

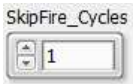

Tip Strip: Specifies the period length, in number of cycles, for the skip fire sequence in EPT Mode (Min = 1).

Detail: Specifies the number of cycles included in a skip fire sequence when the DI injector is operated in EPT mode. For example, if the number 7 is entered, the DI injector will continuously repeat a seven cycle sequence as long as [SkipFire_DI1_ChnX](#) is enabled for the desired channel. It is also manipulated by the corresponding [SkipFire_Cycles](#) controls on the [DI-EPT Pulse Generation Tab](#) and the other [DIX Advanced Settings](#) windows.

12 SkipFire_OnCycle

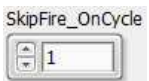

Tip Strip: Specifies the number of active cycles during skip fire sequence in EPT Mode (Min = 1).

Detail: Specifies the number of active cycles included in a skip fire sequence when the DI injector is operated in EPT mode. For example, if the number 4 is entered and [DI SkipFire_Cycles](#) is set to 7, the DI injector will continuously repeat a seven cycle sequence with four active cycles, followed by three inactive cycles as long as [SkipFire_DI1_ChnX](#) is enabled for the desired channel. It is also manipulated by the corresponding [SkipFire_OnCycle](#) control on the [DI-EPT Pulse Generation Tab](#) and the other [DIX Advanced Settings](#) windows.

4.10.3 PFI X Tabs

The PFI X tabs are intended for configuring both EPT and TMP operating modes for the PFI channels of the PFI Driver module X. The EPT and TMP injection pulse command sequences support one pulse and apply it to all four PFI channels of the module. The individual channel enable buttons, operating mode, and current profile parameters for the PFI Driver module are configured via the [PFI and LS Driver Setup](#) window. When the [EPT Mode](#) is selected in the [PFI Module Control](#) tab of the [PFI and LS Driver Setup](#), the TMP parameters of this tab are not applicable. When [TMP Mode](#) is selected in the [PFI Module Control](#) tab of the [PFI and LS Driver Setup](#), the EPT parameters of this tab are not applicable. The lowside driver channels of the PFI Driver module do not have the ability to be operated engine-synchronously and are not configured from this tab (refer to [PFI and LS Driver Setup](#) window). The PFI Driver modules are optional modules for DI Driver Systems and these tabs are not applicable when the modules are not present.

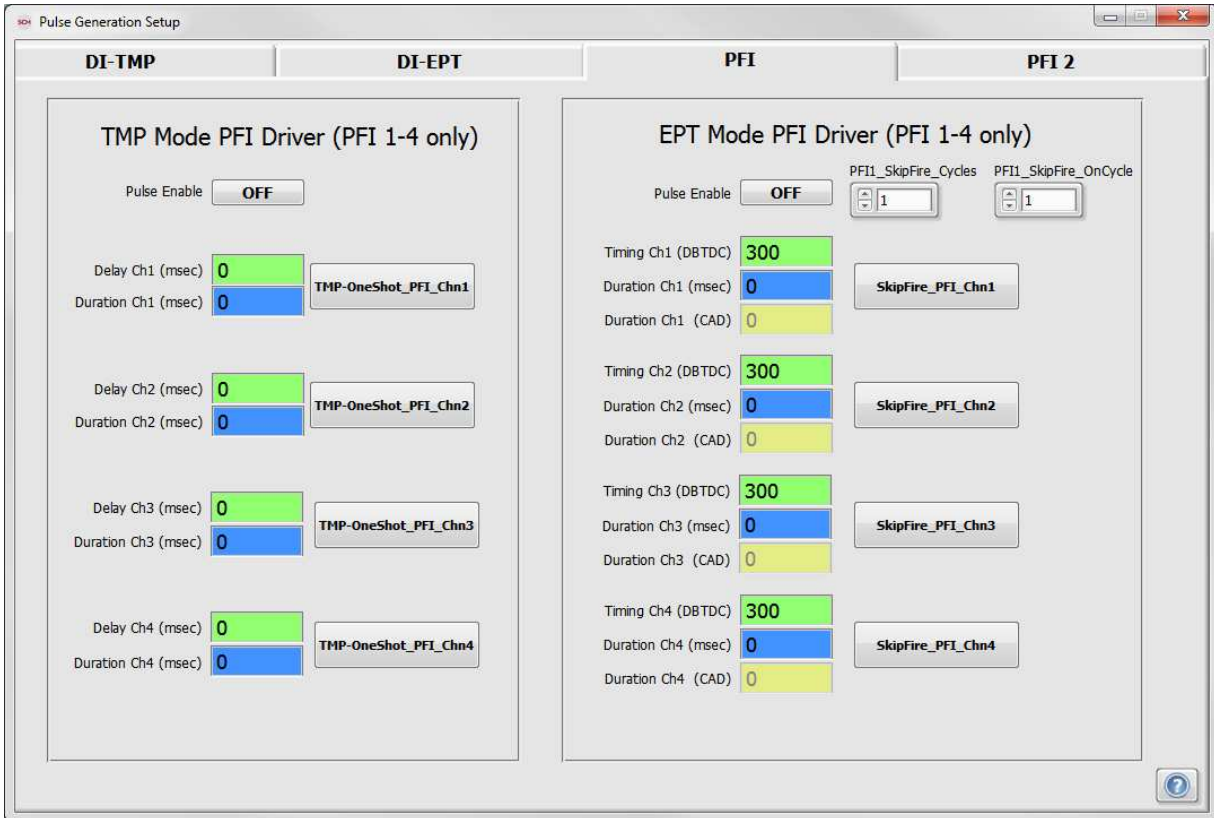

1 Pulse Enable

Pulse Enable

Tip Strip: Enables injection pulse

Detail: When **ON**, the EPT Mode command to the PFI Driver module will be active for the specified duration. When **OFF**, the command will be inactive, but the specified timing and duration will still be implemented. Therefore, the timing of the adjacent pulses will remain the same whether the pulse is **ON** or **OFF**.

2 Timing

Timing (DBTDC)

Tip Strip: Start Of Injection angle with respect to TDC

Units: DBTDC

Detail: Specifies the Start of Injection (SOI) timing in Degrees before TDC.

3 Duration Ch1 (msec)

Duration Ch1 (msec) 0

Tip Strip: Duration of injection pulse

Units: msec

Detail: Time duration of the EPT mode injection pulse. The **ON/OFF** button above each [Timing](#) and [Duration](#) parameter determines whether the pulse will be active or inactive.

4 Duration Ch1 (CAD)

Duration Ch1 (CAD) 0

Tip Strip: Duration of injection pulse

Units: CAD

Detail: This parameter is always disabled but automatically updated with a calculated crank angle degrees duration value. It is calculated based on [Duration](#) (msec) and [engine speed](#) shown in the [EPT](#) Tab of the [Engine Position Tracking](#) Setup window.

5 Duration Ch2-4 (msec) and (CAD)

Duration Ch2 (msec) 0
Duration Ch2 (CAD) 0
Duration Ch3 (msec) 0
Duration Ch3 (CAD) 0
Duration Ch4 (msec) 0
Duration Ch4 (CAD) 0

Tip Strip: Duration of injection pulse

Units: msec and CAD

Detail: See information for [Duration Ch1 \(msec\)](#) and [Duration Ch1 \(CAD\)](#)

6 SkipFire_PFI_ChnX

SkipFire_PFI_Chn1

Tip Strip: Enables Skip Fire on selected DI channel when EPT Mode is selected.

Detail: Enables the skip fire sequence defined by [PFI1_SkipFire_Cycles](#) and [PFI1_SkipFire_OnCycle](#) for its assigned PFI channel.

7 PFI1_SkipFire_Cycles



Tip Strip: Specifies the period length, in number of cycles, for the skip fire sequence in EPT Mode (Min = 1).
Detail: Specifies the number of cycles included in a skip fire sequence when the PFI injector is operated in EPT mode. For example, if the number 7 is entered, the PFI injector will continuously repeat a seven cycle sequence as long as [SkipFire_PFI_ChnX](#) is enabled for the desired channel.

8 PFI1_SkipFire_OnCycle

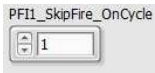

Tip Strip: Specifies the number of active cycles during skip fire sequence in EPT Mode (Min = 1).
Detail: Specifies the number of active cycles included in a Skip Fire Sequence when the DI injector is operated in EPT mode. For example, if the number 4 is entered and [PFI SkipFire_Cycles](#) is set to 7, the PFI injector will continuously repeat a seven cycle sequence with four active cycles, followed by three inactive cycles as long as [SkipFire_PFI_ChnX](#) is enabled for the desired channel. It is also manipulated by the corresponding [SkipFire_OnCycle](#) control in all the [PFI Advanced Settings](#) windows.

9 TMP Pulse Enable



Tip Strip: Enables injection pulse
Detail: When **ON**, the TMP Mode command to the PFI Driver module will be active for the specified duration. When **OFF**, the command will be inactive, but the specified timing and duration will still be implemented. Therefore, the timing of the adjacent pulses will remain the same whether the pulse is **ON** or **OFF**

10 Delay

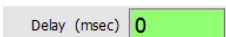

Tip Strip: Time until beginning of this injection pulse
Units: msec
Detail: Specifies the delay of the start of injection from the trigger event.

11 Duration Ch1

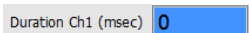

Tip Strip: Duration of injection pulse
Units: msec
Detail: Time duration of the TMP Mode injection pulse. The **ON/OFF** button above each [Delay](#) and [Duration](#) parameter determines whether the pulse will be active or inactive.

12 Duration Ch2-4

Duration Ch2 (msec)	0
Duration Ch3 (msec)	0
Duration Ch4 (msec)	0

Tip Strip: Duration of injection pulse

Units: msec

Detail: See information for [Duration Ch1](#).

13 **TMP-OneShot_PFI_ChnX**



The image shows a vertical stack of four rectangular buttons. Each button has a light gray background and a thin border. The text on each button is bold and black. From top to bottom, the buttons are labeled: "TMP-OneShot_PFI_Chn1", "TMP-OneShot_PFI_Chn2", "TMP-OneShot_PFI_Chn3", and "TMP-OneShot_PFI_Chn4".

Tip Strip: Manually triggers TMP injection command sequence

Detail: Pressing this button will trigger the configured TMP command sequence to the associated PFI Driver module channel. The sequence will be triggered once with each button press.

4.11 Engine Position Tracking Setup Window

The purpose of the Engine Position Tracking (EPT) Setup window is to configure angular position tracking of the engine crankshaft for supervising the generation of engine-synchronous injection commands. The [Engine Position Tracking Setup](#) window contains a tabbed pane with four tabs:

[EPT](#): Tab for configuring parameters related to the EPT functions

[TDC Channel Mapping](#): Tab for assigning Top Dead Center (TDC) values to each DI Driver and PFI Driver channel.

[Cam Phase Capture](#): Tab for configuring the crank angle capture of rising edges of Cam1 and Cam2 signals.

[EPT Diagnostics](#): Tab for diagnosing problems with engine position tracking and signals.

Configuration of EPT is only applicable if one or more of the DI Driver modules or PFI Driver module is configured for **EPT mode**. EPT supports a variety of crank and cam signal patterns, including encoder patterns, N-M patterns and N+1 patterns.

Position Signal Types and Connections

The DI Driver System only supports digital crank and cam position signal types wired to the NI 9411 digital input module(s). Hall-effect sensors are a common example of digital position sensors. They are active sensors requiring power and ground. There are a wide variety of Hall-effect position sensors and they typically have three wires. Some drive their outputs digitally low and high from 0 V (signal ground) to the sensor power supply voltage, resulting in a square-wave pulse as a trigger tooth passes the sensor. The NI 9411 will accept a high digital voltage level up to 24V. Other types of Hall-effect sensors have an open-collector or open-drain output which requires a pullup resistor (typically ~5 KOhm) connected between the sensor output and the sensor power supply voltage. The pullup resistor should be installed as physically close to the NI 9411 module as possible. The sensor data sheet should be consulted for properly connecting the sensor to power, ground, and the NI 9411 digital input channel.

The NI 9411 supports both single-ended and differential digital signal types. Hall-effect sensors typically have single-ended outputs and should be wired to the “a” input pin of its associated digital input channel, while leaving the “b” pin disconnected, or floating. This configuration causes a default 1.5V threshold for detecting a low (FALSE or 0) or high (TRUE or 1) digital input. If the sensor requires a different switching threshold, then a voltage other than 1.5 V can be wired to the “b” pin. This can be accomplished by a simple resistor voltage divider close to the module.

Sometimes, optical encoders have a differential, or complementary pair of outputs for each signal. In this case, the differential pair should be connected to the “a” and “b” pins of the NI 9411 input channel.

In all cases, the sensor ground should be connected to the NI 9411 COM pin as a voltage reference, otherwise the module will not be able to read the proper digital signal level. Refer to the [operating manual for the NI 9411](#) module for further details.

Variable Reluctance (VR) position sensors are not supported by the DI Driver System. VR position sensors are passive sensors and are sometimes referred to as inductive or magnetic (“mag”) pickup sensors. They typically have only two wires. These sensors output a positive/negative sinusoidal waveform with an amplitude proportional to the speed of the trigger wheel. The NI 9411 digital input module does not support such waveforms.

Supported Pattern Types

The EPT function supports three crank and cam pattern types described in Table 4.11.a below.

Pattern Type	EPT Type Selections	Pattern Description
N - M	EPT N-M 7	<p>N-M patterns have N evenly spaced teeth and M missing adjacent teeth (gap) on the crankshaft trigger wheel. M is limited to 1 or 2 missing teeth. N is stated in terms of evenly spaced teeth, as if there were no missing teeth. For example, a 60-2 pattern would consist of 58 physical teeth followed by two missing teeth. EPT N-M function can be configured to track 360 or 720 degrees depending upon an optional camshaft input. When tracking 360 degrees for 2-stroke engines, the camshaft input is ignored. When tracking 720 degrees for 4-stroke engines, the camshaft input signal must be TRUE during every other crank tooth gap. The cam signal can be manipulated using the offset and extend functions to satisfy this requirement.</p>
N + 1	EPT N+1 9	<p>N+1 patterns have N evenly spaced teeth and a single additional tooth (Plus1), placed between two evenly spaced teeth, on the crankshaft trigger wheel. The Plus1 tooth can be located at one of two different positions between two evenly spaced teeth, advanced or retarded. N is stated in terms of evenly spaced teeth, as if there were no additional teeth. For example, a 6+1 pattern would consist of 6 physical evenly spaced teeth and an additional physical tooth placed between two evenly spaced teeth. EPT N+1 function can be configured to track 360 or 720 degrees depending upon an optional camshaft input. When tracking 360 degrees for 2-stroke engines, the camshaft input is ignored. When tracking 720 degrees for 4-stroke engines, the camshaft input signal must be TRUE during every other Plus1 tooth. The cam signal can be manipulated using the offset and extend functions to satisfy this requirement.</p>

		<p>teeth rising edges each engine cycle. The EPT Encoder function can be configured to track 360 or 720 degrees. When tracking 360 degrees, the reference tooth is located on the crankshaft, yet is directed to the CamSig input of the EPT function. When tracking 720 degrees, the reference tooth is located either on the crankshaft or on the camshaft. When located on the crankshaft, then an additional cam phase signal must be present in order to mask (using EncZMask) every other crank reference, such that every other crank reference is allowed to pass through to the CamSig input of the EPT function. This would cause the crank encoder pattern to effectively generate twice the teeth between each reference tooth seen by the EPT function.</p>
--	--	--

Table 4.11.a, Supported EPT Patterns

Brief Glossary of EPT Function Terms

CAD: Crank Angle Degrees. There are 360 CAD per two stroke cycle or one crankshaft rotation. There are 720 CAD per 4-stroke cycle, or two crankshaft rotations. In a 4-stroke engine, the camshaft completes exactly one rotation per two rotations of the crankshaft. There are two strokes of the piston (up and down) within the cylinder during a single rotation of the crankshaft. A single stroke of the piston covers 180 CAD.

EXTRAP: The single numerical digit suffix of each EPT function selection refers to the level of EPT Position Extrapolation. This is a fixed power of two by which the angular resolution of tracked crankshaft position is improved over the physical teeth alone. For example, if the EPT function has a fixed extrapolation level of 7, then the crank angle resolution between each physical tooth is improved by a factor of $2^7 = 128$. Each individual extrapolated angle unit between the physical crank teeth is called a Crank Angle Tick (CAT)

CAT: Crank Angle Ticks. Single unit of angular measure of the EPT function. Reported as a power-of-two angular ticks of crank position travel, having a resolution dependent on EXTRAP and the number of physical teeth per crankshaft rotation. For example, if using the N-M EPT VI, which has an extrapolation of 7, the number of CAT per crank tooth would be $2^7=128$, and angular position would be evenly incremented by 128 CAT from one physical tooth to the next. If a 60-2 pattern were used, the maximum number of CAT per crankshaft rotation would be $60*128=7680$. If the engine was a 4-stroke, the total number of CAT per engine cycle would be $2*60*128=15360$.

MAX_CAT: Maximum Crank Angle Ticks per engine cycle.

EPT Function Commonality

EPT Input Signals

All EPT functions have a common internal core that tracks angular position. The supporting internal logic around the core interprets the incoming crank and cam position pulses according to an expected pattern. Each EPT function has a Boolean crankshaft and camshaft input. These signals may be connected via any available NI 9411 digital input source within the DI Driver System. The pattern input signals are named according to the most common engine applications, such that there is a crankshaft trigger wheel and an optional 4-stroke camshaft trigger wheel. However, it is also possible to operate with a single trigger wheel mounted to a camshaft of a 4-stroke engine. This would require routing the physical camshaft trigger wheel sensor signal into the Crank_DigChanAsn of the DI Driver System. Refer to the [Digital Input Setup](#) window description for assigning NI 9411 digital inputs to internal signals.

Digital Signal Filtering

It is often necessary to implement filtering of the crank and/or cam signals prior to entering the EPT function. The DI Driver System software provides an integrating filter function which rejects positive and negative digital signal pulses having a pulse width less than the filter time. Refer to the [Digital Input Setup](#) window description for further information about filtering the NI 9411 digital inputs.

EPT Pattern Simulation

All EPT functions contain a built in pattern simulation tool specific to the pattern for which the EPT function was configured. Pattern simulation is turned on simply by setting [EngineSimEnable](#) button of the [EPT tab](#) to **TRUE** and setting the [SimulatedSpeed](#) to an appropriate value for the simulated speed. When simulation is turned on, the Crank and Cam inputs to the EPT function are internally disconnected and replaced by the internally simulated counterparts. The simulation feature allows the designer to bench test the DI Driver System functionality at any stage of the development without the need for external simulation hardware.

Achieving Sync

In order for position tracking (sync) to start, a few conditions must be met. First, some pattern specific values must be set correctly to the EPT function, such as [NumberOfCrankTeeth](#), [NumberOfMissingTeeth](#) (if N-M), [Stroke](#), and [StallSpeed](#). Next, the [SyncEnable](#) must be turned **ON**. Next, the [EngineSpeed](#) must exceed the [StallSpeed](#). When the stall speed (RPM) is exceeded, the [CrankStalled](#) indicator will be set to **Spinning** and the EPT function begins counting a complete cycle of crank teeth. After a complete engine cycle of crank teeth is received, the EPT function begins looking for the first occurrence of a unique feature of the crankshaft and camshaft pattern which identifies an absolute position. For example, if an N-M pattern is being used, the function searches for the occurrence of the M-tooth gap. This is the moment of achieving sync. When sync is achieved, the [SyncStopped](#) indicator is set to **Sync** and the angular position of the crankshaft will be tracked. As sync is maintained, [CrankCount](#) will show the latest crankshaft tooth count with respect to absolute 0 position. Each EPT function will have different rules for achieving and maintaining sync, as well as location for absolute position 0. This information is contained in the EPT Pattern-Specific Information section below.

CrankCount

During sync, the EPT function provides the latest crank tooth count at the [CrankCount](#) indicator, referenced to tooth 0. Tooth 0 is determined according to the pattern that is being tracked and is discussed within the Pattern-Specific Information section below. [CrankCount](#) is provided in terms of a complete engine cycle and is reported as if there were no missing or extra teeth in the pattern. For example, if the pattern type is N-M, [NumberOfCrankTeeth](#) = 60 and [Stroke](#) = TRUE, then [CrankCount](#) will range from 0 to 119. [CrankCount](#) is for monitoring purposes only.

Crank Position

During sync, the EPT function calculates the latest crankshaft position in terms of absolute Crank Angle Ticks (CAT) over a complete engine cycle, referenced to position 0. It is internally converted to a crank angle position in terms of Crank Angle Degrees (CAD), referenced to position 0, so that injection angles may be specified in CAD. Position 0 is determined according to the pattern that is being tracked and is discussed within the Pattern-Specific Information section below. The CurrentPosition in CAD is calculated according to the following:

$$\text{CurrentPosition(CAD)} = [\text{CurrentPosition(CAT)} * \text{Stroke} * 360] / \text{MAX_CAT}$$

Where Stroke = 2 if 4-stroke, and Stroke = 1 if 2-stroke.

CurrentPosition is not displayed on the EPT tab because it changes very rapidly.

Position Tracking

Between each crank tooth, CurrentPosition is incremented smoothly at a rate proportional to the previous crank tooth period. In the presence of crankshaft acceleration or deceleration, sync is still properly maintained. If a new crank tooth is received before CurrentPosition has incremented to the correct position, then CurrentPosition is incremented at a faster rate until proper synchronization is achieved. CurrentPosition is then further incremented at a rate proportional to the previous crank tooth period. If CurrentPosition reaches the correct position expected for the next tooth before the tooth is received, then CurrentPosition holds its value until the next crank tooth.

EPT Function Selection

There are four EPT function selections available in the [EPT_Type](#) drop-down list. Each EPT function type is optimized for a particular range of number of crank teeth. For example, the DI Driver System provides two encoder pattern EPT functions, each optimized for different ranges of crank tooth counts. The suggested tooth count ranges are shown below in Table 4.11.b for each pattern type selection. The EPT function extrapolation value, which is the single-digit suffix of each EPT_Type selection, will affect the CAD resolution of the internally calculated CurrentPosition. The worst case resolution is 0.500 CAD for very low encoder pattern tooth counts.

For example, if using a 4-stroke 36-1 pattern, then the suggested EPT function is the “EPT N-M 7”. The “7” component of the selection refers to the number of bits of binary extrapolation of crank angle between each crank tooth. In this case, CurrentPosition would increment by 2^7 , or 128 CAT, between each crank tooth. The range of CurrentPosition would be from 0 to $MAX_CAT = 2 * 36 * 128 = 9216$. This is the total number of angular positional ticks that are tracked by the EPT over a complete 4-stroke engine cycle. Therefore CurrentPosition will track from 0 to 9216 and roll over to 0 at the occurrence of tooth 0. This provides an angular resolution of 0.078 CAD/CAT. The calculated CurrentPosition is maintained with a 16-bit integer and cannot exceed 65535. Therefore, [NumberOfCrankTeeth](#) should not exceed a value that causes [MaxCAT](#) to exceed 16-bit representation. The calculated [MaxCAT](#) value is displayed on the EPT tab.

Pattern Type	NumberOfCrankTeeth	Stroke	Extrapolation	MaxCAT
EPT ENC 2 (max)	3600	4	2	28800
EPT ENC 2 (min)	180	4	2	1440
EPT ENC 4 (max)	720	4	4	23040
EPT ENC 4 (min)	45	4	4	1440
EPT N-M 7 (max)	120	4	7	30720
EPT N-M 7 (min)	12	4	7	3072
EPT N+1 9 (max)	24	4	9	24576
EPT N+1 9 (min)	4	4	9	4096

Table 4.11.b, EPT function Extrapolation Values and Suggestion Tooth Count Ranges

Loss of Sync

The EPT will lose sync under normal conditions if the crankshaft speed falls below the stall speed, as specified by the [StallSpeed](#) parameter of the EPT tab. Keep in mind that the EPT function uses a 24-bit, 40MHz timer to measure the period between each physical tooth. Therefore, a [StallSpeed](#) should be specified such that the tooth period timer

will not exceed 24-bit representation. This is a straight-forward calculation for encoder patterns. For example, if a 180-count encoder were used on the crankshaft, and it is desired to have a [StallSpeed](#) of 50 RPM, then the resulting tooth period timer for that speed (266666) must be checked so that it does not exceed a 24-bit value (2^{24}). It does not, so a [StallSpeed](#) of 50 RPM is acceptable. When EPT N-M 7 function is selected, extra attention must be given to the [StallSpeed](#) parameter. For example, if a 60-2 crank pattern is used, then there is a two-tooth gap, which means that the timer period during the gap will be three times the period between the other evenly spaced teeth. A true crankshaft [StallSpeed](#) of 50 RPM correlates to an evenly spaced tooth period of 20 milliseconds. Therefore, the period during the gap would be 60 milliseconds at 50 RPM. Sixty milliseconds correspond to a 40 MHz timer value of 2400000, which can be represented by a 24-bit value. Therefore, a 50 RPM [StallSpeed](#) is acceptable for this example.

The EPT function will lose sync in error when missing or extra crank/cam pulses are encountered where unexpected. In all conditions, when sync is lost, [CrankCount](#) will be set to 0 and [SyncStopped](#) will be set to "Stopped". A loss of sync due to an error condition will be further signaled by the appropriate pattern-specific error flag on the EPT tab. An error condition causing loss of sync will prevent any further sync until the error flag is cleared using the [SyncFlagClear](#) button on the EPT tab. An obvious possible reason for such errors would be that the crank or cam trigger wheel pattern does not match the configuration of the selected EPT function. If this is the case, the EPT will either not sync at all or will lose sync almost immediately after initial sync. Assuming that the trigger wheel pattern is correct, there is another common source of sync errors, which is electrical noise. This problem is discussed below, along with some diagnostic techniques.

Electrical Noise

Electrical noise can be picked up and manifested in a wide variety of ways. There are a few guidelines that should be followed for ensuring appropriate immunization against electrical noise. It is unlikely that noise will be introduced on the crank or cam signals between the NI 9411 module and the cRIO controller. It is most likely that electrical noise will be picked up along the wires between the sensor and the external connection to the NI 9411 module. If possible, the wiring for sensors should be twisted shielded pairs and as short as possible. There should be few electrical connections between the sensor and the module. The signals should be routed away, if possible, from high-current wires such as injector wires or dynamometer wiring. The NI 9411 module should have a sensor signal ground connected to its COM pin. Efforts should be made to fully understand all ground connections within the system, making sure that ground connections are made in a "star" fashion instead of daisy-chain. Daisy-chain grounding can lead to problematic ground loops where sensors and actuators use signal ground reference wires as a return path for current back to ground. The wire used for NI 9411 COM ground reference should not be considered as a power ground return path. If noise spikes are still causing false triggering of the digital input circuit, digital filtering may be implemented within the DI Driver System using the integrated digital filter function. The digital filter rejects signal pulses up to a specified width. The filter times are specified via the [Digital Input Setup](#) window. It is common to use a filter time of 1 to 5 microseconds. If filter times higher than 10 microseconds are required, then it is likely that noise problems can be resolved in the external wiring.

Troubleshooting

Achieving reliable, clean crank and cam signals can sometimes be a trial and error process. It is National Instruments' experience that reliable sync is often not achieved with the first attempt at running the engine over the entire speed and load range. Even though sync may occur successfully at low engine speeds, it does not always mean that sync will be consistent at high speeds or loads due to trigger wheel imperfections, sensor placement distance from the trigger teeth, ignition or injection radiated noise, or camshaft position lash or stretch with respect to the crankshaft. The system engineer should take care to check that external signal shielding and routing are optimal and that there is plenty of signal-edge margin for cam belt or chain stretch.

The [EPT Diagnostics](#) tab can be used to capture the crank and cam signals for diagnosing post-filter problems with extraneous pulses or pulse alignment. The [EPT Diagnostics](#) tab can continuously display crank and cam signals and then be stopped for analysis. The signals can be captured upon a loss of sync trigger to look at the crank and cam signals captured before the loss of sync.

EPT Pattern-Specific Information

N-M Patterns

Pattern Description:

N-M patterns have N evenly spaced teeth and M missing adjacent teeth (gap) on the crankshaft trigger wheel. M is limited to 1 or 2 missing teeth. N is stated in terms of evenly spaced teeth, as if there were no missing teeth. For example, a 60-2 pattern would consist of 58 physical teeth followed by two missing teeth. EPT N-M function can be configured to track 360 or 720 degrees depending upon an optional camshaft input. When tracking 360 degrees for 2-stroke engines, the camshaft input is ignored. This is designated by configuring the function with [Stroke](#) = 2-STROKE. When tracking 720 degrees for 4-stroke engines, the camshaft input signal must be TRUE during every other crank tooth gap. This is designated by configuring the VI with [Stroke](#) = 4-STROKE.

2-Stroke Applications:

Position 0 and tooth 0 coincide with the first tooth following each crank tooth gap. The [CamSig](#) input is ignored. [CrankCount](#) will increment from 0 to [NumberOfCrankTeeth](#) - 1. During crank tooth gaps, [CrankCount](#) will continue to increment at the location of each missing tooth. For example, if [NumberOfCrankTeeth](#) (N) = 60 and [NumberOfMissingTeeth](#) (M) = 2, then [CrankCount](#) would increment from 0 to 59, such that teeth 58 and 59 would correspond to the two missing teeth and tooth 0 would correspond to the tooth following missing tooth 59.

4-Stroke Applications:

Position 0 and tooth 0 coincide with the first tooth following the crank tooth gap while the [CamSig](#) input is TRUE. The [CamSig](#) is only used for achieving initial sync. Once sync is achieved, it is maintained according to the location of each gap. However, [CamSig](#) is still monitored to report whether the signal is normally alternating high and low at each gap. The [CamHistory](#) indicator of the EPT tab reports whether the signal is “Normal”, “Always High”, “Always Low”, or an unexpected pattern reported as “Error”. [CrankCount](#) will increment from 0 to 2*[NumberOfCrankTeeth](#) - 1. During crank tooth gaps, [CrankCount](#) will continue to increment at the location of each missing tooth. For example, if [NumberOfCrankTeeth](#) (N) = 60 and [NumberOfMissingTeeth](#) (M) = 2, then [CrankCount](#) would increment from 0 to 119, such that teeth 58 and 59 would correspond to the two missing teeth while [CamSig](#) is FALSE. Teeth 118 and 119 would correspond to the two missing teeth while [CamSig](#) is TRUE. Tooth 0 would correspond to the tooth following missing tooth 119.

It is allowed for [CamSig](#) to have more than one pulse per cycle, as long as the signal is high and low during the correct crank tooth gap for the correct phase of the engine. In some applications [CamSig](#) may only be a single short pulse which is not high during either crank tooth gaps. In this case, the [CamOffset](#) and [CamExtension](#) parameters may be used to move the cam signal forward by a specified number of crank teeth and extend the [CamSig](#) for a specified number of crank teeth in order to cover one of the gaps. The Cam Offset function results in the cam signal width being equal to one crank tooth period; therefore, the extension function is required to extend it over the appropriate gap.

N+1 Patterns

Pattern Description:

N+1 patterns have N evenly spaced teeth and a single additional tooth (Plus1), placed between two evenly spaced teeth, on the crankshaft trigger wheel. There are two different sub-configurations within this pattern type, specified by the Plus1Location button. An advanced Plus1 tooth must be positioned such that it is advanced from the midpoint between two evenly spaced teeth. The amount of advance must be at least $\frac{1}{4}$ of the normal tooth spacing. A retarded Plus1 tooth must be positioned such that it is retarded from the midpoint between two evenly spaced teeth. The amount of retard must be at least $\frac{1}{4}$ of the normal tooth spacing. N is stated in terms of evenly spaced teeth, as if there were no additional teeth. For example, a 6+1 pattern would consist of 6 physical evenly spaced teeth and an additional physical tooth placed between two evenly spaced teeth. EPT N+1 function can be configured to track 360 or 720 degrees depending upon an optional camshaft input. When tracking 360 degrees for 2-stroke engines, the

camshaft input is ignored. This is designated by configuring the function with [Stroke](#) = 2-STROKE. When tracking 720 degrees for 4-stroke engines, the camshaft input signal must be TRUE during every other Plus1 tooth. This is designated by configuring the function with [Stroke](#) = 4-STROKE.

2-Stroke Applications (Stroke = FALSE):

For advanced Plus1 tooth configurations, position 0 and tooth 0 coincide with the first tooth following the Plus1 tooth. For retarded Plus1 tooth configurations, position 0 and tooth 0 coincide with the second tooth following the Plus1 tooth. The [CamSig](#) input is ignored. [CrankCount](#) will increment from 0 to [NumberOfCrankTeeth](#) - 1. [CrankCount](#) will not be incremented at the location of the Plus1 tooth. For example, if the Plus1 tooth is advanced, and [NumberOfCrankTeeth](#) = 6, then [CrankCount](#) would increment from 0 to 5, such that tooth 5 would correspond to the tooth immediately before the Plus1 tooth and tooth 0 would correspond to the tooth immediately following the Plus1 tooth. As another example, if the Plus1 tooth is retarded, and [NumberOfCrankTeeth](#) = 6, then [CrankCount](#) would increment from 0 to 5, such that tooth 5 would correspond to the tooth immediately after the Plus1 tooth and tooth 0 would correspond to the second tooth following the Plus1 tooth.

4-Stroke Applications (Stroke = TRUE):

For advanced Plus1 tooth configurations, position 0 and tooth 0 coincides with the first tooth following the Plus1 tooth while the [CamSig](#) input is TRUE. For retarded Plus1 tooth configurations, position 0 and tooth 0 coincide with the second tooth following the Plus1 tooth while the [CamSig](#) input is TRUE. The [CamSig](#) is actually only used for achieving initial sync. Once sync is achieved, it is maintained according to the location of each Plus1 tooth. However, [CamSig](#) is still monitored to report whether the signal is normally alternating high and low at each Plus1 tooth. The [CamHistory](#) indicator of the EPT tab reports whether the signal is “Normal”, “Always High”, “Always Low”, or an unexpected pattern reported as “Error”. [CrankCount](#) will increment from 0 to $2 * \text{NumberOfCrankTeeth} - 1$. [CrankCount](#) will not increment at the Plus1 tooth. For example, if the Plus1 tooth is advanced, and [NumberOfCrankTeeth](#) = 6, then [CrankCount](#) would increment from 0 to 11, such that tooth 5 and tooth 11 would correspond to the tooth immediately before the Plus1 tooth while [CamSig](#) is FALSE and [CamSig](#) is TRUE, respectively. Tooth 6 and tooth 0 would correspond to the tooth immediately following the Plus1 tooth while [CamSig](#) is FALSE and [CamSig](#) is TRUE, respectively.

Tooth numbering for the two different Plus1 tooth location configurations is shown in figures 4.11.c and 4.11.d below.

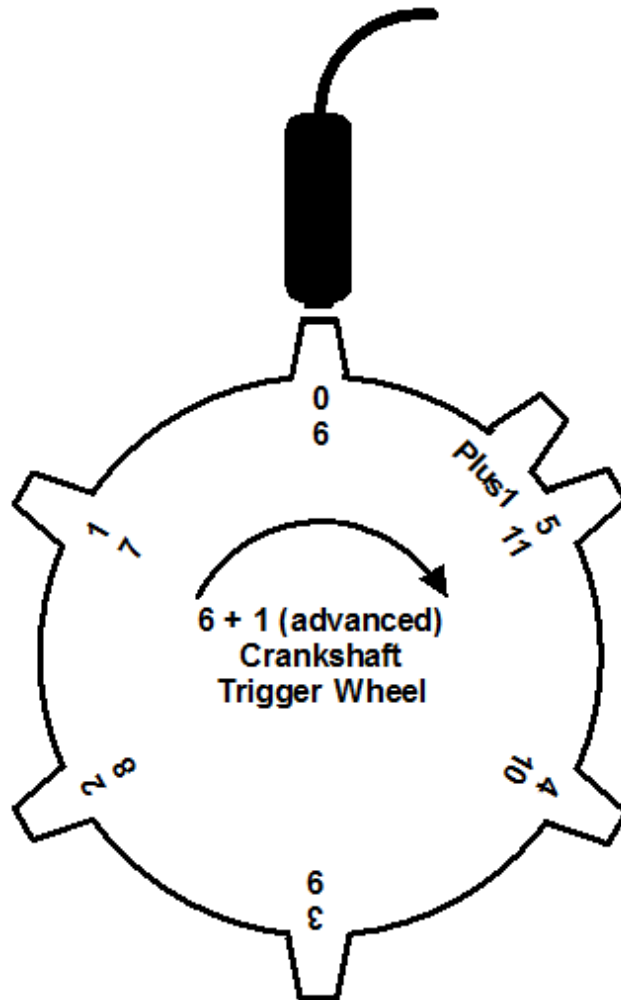

Figure 4.11.c, 6+1 (advanced) crankshaft trigger wheel tooth numbering

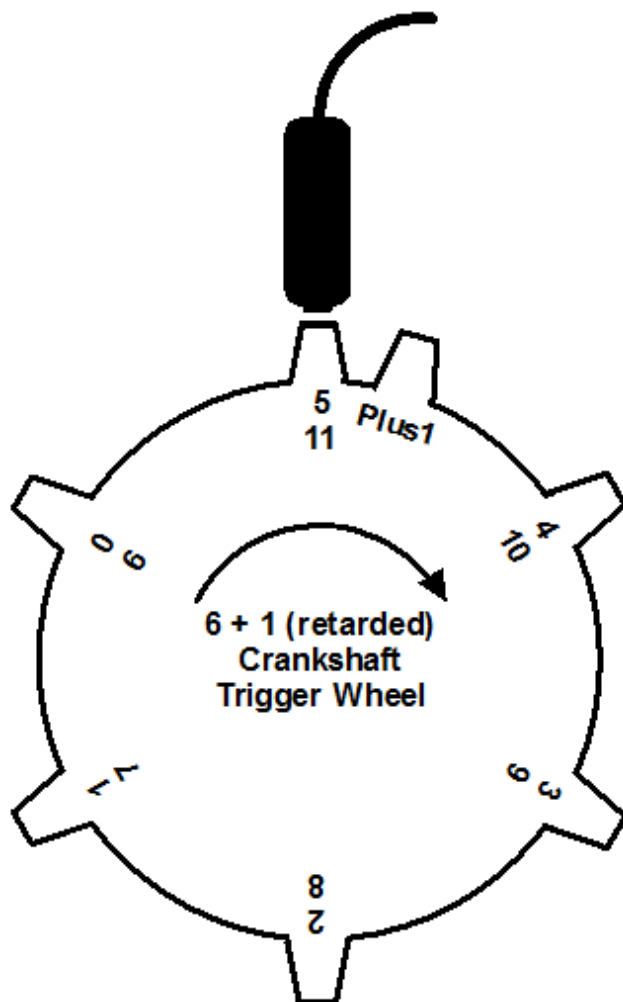

Figure 4.11.d, 6+1 (retarded) crankshaft trigger wheel tooth numbering

Encoder Patterns

Pattern Description:

Encoder patterns have N evenly spaced teeth on the crankshaft with a separately sensed single reference (index, [EncZ](#)) tooth on the crankshaft or camshaft. The rising edge of the reference must occur between the same two crankshaft teeth rising edges each and every cycle. The EPT ENC function can be configured to track 360 or 720 degrees. When tracking 360 degrees, the reference tooth is located on the crankshaft, yet is internally connected to the [CamSig](#) input of the EPT function via the [EncZ](#) digital input. When tracking 720 degrees, the reference tooth is located either on the crankshaft or on the camshaft. When located on the crankshaft, then an additional cam phase signal must be present in order to mask (using [EncZMask](#)) every other crank reference, such that every other crank reference is allowed to pass through to the [CamSig](#) input of the EPT function. Encoder style patterns are a very common form of engine position tracking in both production and research engine control systems.

Production Engine Encoder Patterns:

In production engines, an encoder pattern will typically consist of a trigger position sensor sensing a relatively low resolution crankshaft trigger wheel. The camshaft trigger position sensor is sensing a single tooth on the cam. For this configuration, the cam position signal should be routed to the DI Driver System [EncZ](#) signal via the [Digital Input Setup](#) window, and the [EncZMask](#) button of the EPT tab should be set to **EncZ Passed**. For this configuration, the rising edge of the cam signal should occur as close as possible to the midway point between two crank signals. The system designer should also ensure that the camshaft lash due to stretching of the camshaft belt or chain during acceleration or deceleration will not cause the cam signal to move with respect to the crank signals by more than half of the crank tooth spacing. For this reason, production systems will use a low resolution crank trigger wheel. The

[EncZ](#) signal may be inverted via the [Digital Input Setup](#) window to properly present a rising edge between the same two crank rising edges, each and every engine cycle.

Research Engine Encoder Patterns:

Optical encoders are a common source of signals for this pattern type in research applications. A single optical encoder will typically have three different outputs named A, B and Z. Signals A and B are quadrature encoded 90 degrees out of phase, while Z is a single reference pulse per 360 degrees rotation of the encoder shaft. Signal A or B (not both, typically A) may be wired to the Crank digital input while signal Z must be wired to the [EncZ](#) digital input. Encoders having pulse-counts of 360 to 3600 pulses per rotation are common for research engine control applications, although any pulse count may be used. The EPT ENC function will then extrapolate this to an improved resolution, depending on the EPT extrapolation level.

If the optical encoder is mounted to the crankshaft, then [NumberOfCrankTeeth](#) should be set to the encoder pulse-count and Stroke should be set according to the engine type – 2-STROKE or 4-STROKE. If the engine is a 4-stroke, then a cam phase signal must be present and logically gated ([EncZMask](#)) with the Z pulse, so that every other Z pulse is allowed to pass through. The gating function is accomplished by setting the [EncZMask](#) button to **EncZ Masked**. The result will be that the EPT function will see two full rotations of crank pulses for every Z pulse. The cam phase signal may be a complex pattern, as long as it provides a consistent TRUE state for one Z pulse and a FALSE state for the next, repeating this pattern. The [Cam offset and extension functions](#) can be used to adjust the cam phase signal in order to meet the proper masking requirement of the Z pulse.

If the engine is a 2-stroke, then the [EncZMask](#) button of the EPT tab should be set to **EncZ Passed**.

If the optical encoder is mounted to the camshaft, then [NumberOfCrankTeeth](#) should be set to the encoder pulse-count divided by two, Stroke should set to 4-STROKE, and the [EncZMask](#) button should be set to **EncZ Passed**. This setup will track 720 degrees.

With encoder patterns, position 0 and tooth 0 correspond to the rising edge of the first [CrankSig](#) tooth following the rising edge of the [EncZ](#) input.

4.11.1 EPT Tab

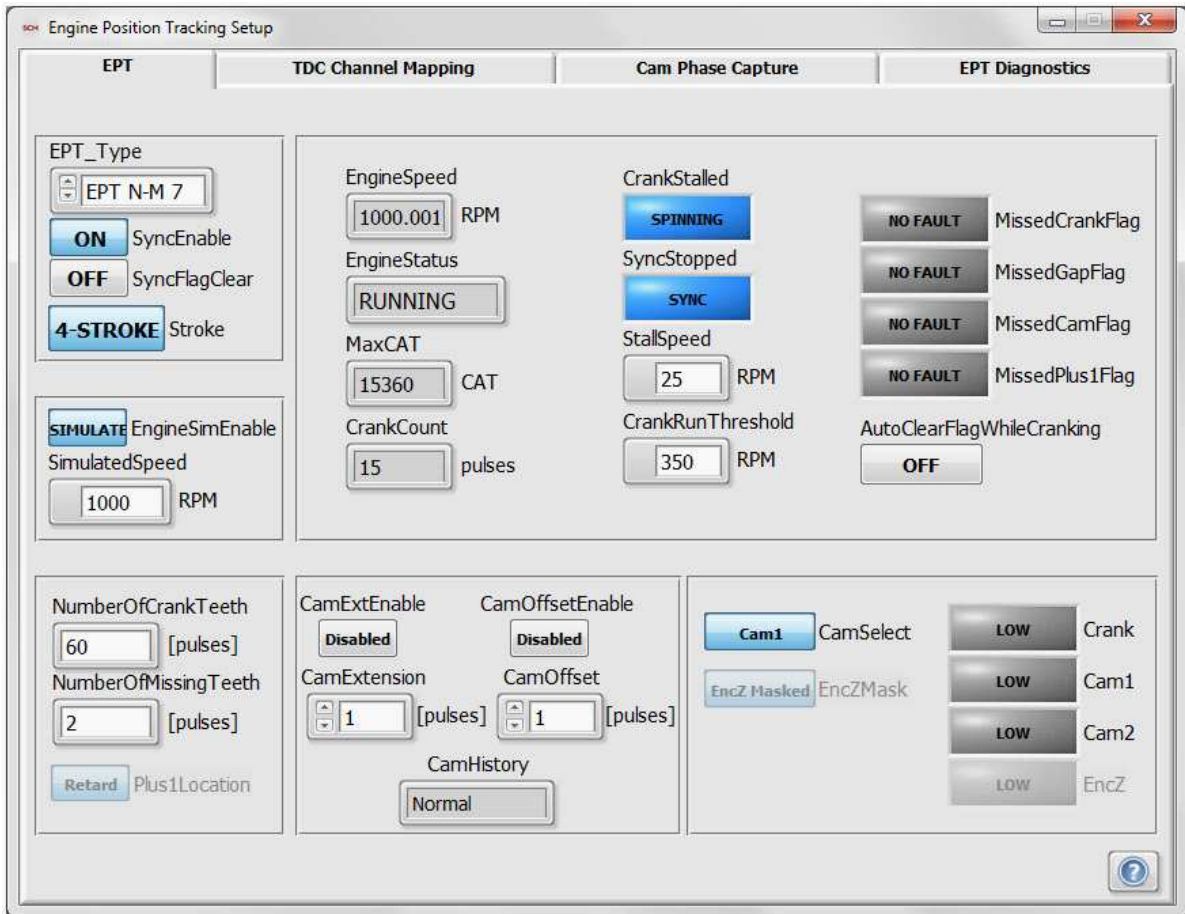

1 EPT_Type

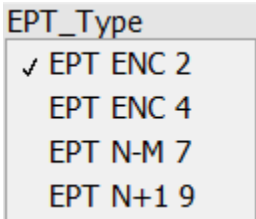

Tip Strip: Selects pattern type for the EPT function

Detail: EPT function selection for pattern type and extrapolation level. Some pattern type selections only support one level of extrapolation due to the typical number of crank teeth for that pattern type. Refer to tables 4.11.a and 4.11.b in the [Engine Position Tracking Setup](#) window section for pattern support details.

EPT ENC 2: Supports encoder pattern types and extrapolates to $2^2=4$ Crank Angle Ticks (CAT) between each crank tooth.

EPT ENC 4: Supports encoder pattern types and extrapolates to $2^4=16$ CAT between each crank tooth.

EPT N-M 7: Supports N-M pattern types and extrapolates to $2^7=128$ CAT between each crank tooth. M can be one or two missing adjacent teeth.

EPT N+1 9: Supports N+1 pattern types and extrapolates to $2^9=512$ CAT between each crank tooth.

2 SyncEnable

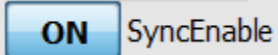

Tip Strip: Enables EPT to sync

Detail: When **ON**, sync is enabled and position tracking will take place if valid crank and cam signal patterns are presented to the EPT function at an engine speed greater than the stall speed.

3 SyncFlagClear

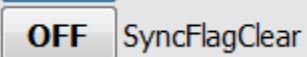

Tip Strip: Clears EPT errors

Detail: When **ON**, any of the following errors will be cleared: [MissedCrankFlag](#), [MissedGapFlag](#), [MissedCamFlag](#), and [MissedPlus1Flag](#). This button will reset itself after being pressed.

4 Stroke

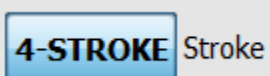

Tip Strip: Piston strokes per engine cycle

Detail: When **2-STROKE**, the EPT is tracking teeth from 0 to NumberOfCrankTeeth. When **4-STROKE**, the EPT is tracking teeth from 0 to 2xNumberOfCrankTeeth.

5 EngineSimEnable

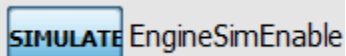

Tip Strip: Enables simulation of select EPT type

Detail: When **SIMULATE**, [CrankSig](#) and [CamSig](#) inputs are internally disconnected from the EPT function and simulated signals are connected in their place.

6 SimulatedSpeed

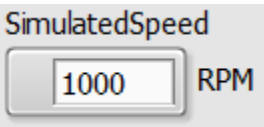

Tip Strip: Simulated engine speed during Simulation mode

Units: RPM

Detail: The simulated crank speed of the simulated signals to the EPT function when [EngineSimEnable](#) is set to **SIMULATE**. The EPT will not sync to the simulator unless the engine speed is greater than the [StallSpeed](#).

7 NumberOfCrankTeeth

NumberOfCrankTeeth

60 [pulses]

Tip Strip: Number of crank pulses per rotation

Units: pulses

Detail: Specifies the number of teeth on the crankshaft trigger wheel as if there were no missing or extra crank teeth. For example, a 60-2 crankshaft pattern would have [NumberOfCrankTeeth](#) = 60. For encoders this is the pulses per revolution.

8 NumberOfMissingTeeth

NumberOfMissingTeeth

2 [pulses]

Tip Strip: Number missing adjacent crank teeth for the gap. M = 1 or 2.

Units: pulses

Detail: Specifies the number of missing adjacent teeth on the crankshaft trigger wheel for an [N-M pattern](#) type. For example, a 60-2 crankshaft pattern would have [NumberOfMissingTeeth](#) = 2. This parameter is only applicable for [N-M pattern](#) types.

9 Plus1Location

Retard Plus1Location

Tip Strip: Plus1 tooth location with respect to mid-point

Detail: When **Advance**, the EPT is configured to look for a Plus1 tooth which is advanced from the mid-point between two evenly spaced crank teeth. An advanced Plus1 tooth should be advanced from the mid-point by approximately $\frac{1}{4}$ of the normal tooth spacing. When **Retard**, the EPT is configured to look for a Plus1 tooth which is retarded from the midpoint between two evenly spaced crank teeth. A retarded Plus1 tooth should be retarded from the mid-point by approximately $\frac{1}{4}$ of the normal tooth spacing. This parameter is only applicable for Plus1 pattern types.

10 EngineSpeed

EngineSpeed

1000.001 RPM

Tip Strip: Indicates engine speed

Units: RPM

Detail: Engine speed output from the EPT function.

11 EngineStatus

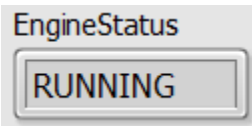

Tip Strip: Engine status based on StallSpeed and CrankRunThreshold

Detail: Indicates the status of the engine crankshaft as stalled, cranking, or running, depending on the values of [StallSpeed](#) and [CrankRunThreshold](#).

STALLED: Crank speed is less than [StallSpeed](#)

CRANKING: Crank speed is greater than [StallSpeed](#) and less than [CrankRunThreshold](#)

RUNNING: Crank speed is greater than [CrankRunThreshold](#)

12 MaxCAT

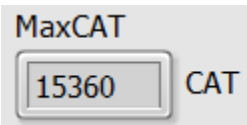

Tip Strip: Maximum crank angle ticks for complete engine cycle

Units: CAT

Detail: Maximum Crank Angle Ticks per engine cycle. A Crank Angle Tick (CAT) is a single unit of angular measure by the EPT function. [MaxCAT](#) is reported as power-of-two angular ticks of crank position travel, having a resolution dependent on binary extrapolation level and the number of physical teeth per crankshaft rotation. For example, if using the [N-M EPT VI](#), which has an extrapolation of 7, the number of CAT per crank tooth would be $2^7=128$, and the internally calculated CurrentPosition would be evenly incremented by 128 CAT from one physical tooth to the next. If a 60-2 pattern were used and the engine was a 2-stroke, the [MaxCAT](#) per engine cycle would be $60*128=7680$. If the engine was a 4-stroke, the [MaxCAT](#) per engine cycle would be $2*60*128=15360$.

13 CrankCount

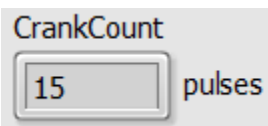

Tip Strip: EPT crank pulse count while in sync

Units: pulses

Detail: The latest tooth count referenced to crank tooth 0. Tooth 0 is determined according to the pattern that is being tracked and is discussed within the [pattern specific EPT documentation](#). Also see the description for [GlobalTDCOffset](#). [CrankCount](#) is provided in terms of a complete engine cycle and is reported as if there were no missing or extra teeth in the pattern. For example, if [PATTERN](#) = N-M, [NumberOfCrankTeeth](#) = 60 and [Stroke](#) = 4-STROKE, then [CrankCount](#) will range from 0 to 119.

14 CrankStalled

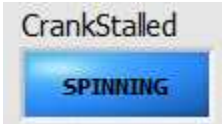

Tip Strip: Indicates engine speed is below [StallSpeed](#)

Detail: Indicates **STALLED** when the engine speed is below [StallSpeed](#). Indicates **SPINNING** when the engine speed is above [StallSpeed](#).

15 SyncStopped



Tip Strip: Indicates EPT is not in sync with engine

Detail: Indicates **STOPPED** while position tracking is not taking place. In other words, there is no synchronization acquired with the crank and cam signals. Indicates **SYNC** while position tracking is taking place.

16 StallSpeed

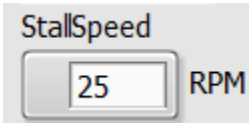

Tip Strip: Engine speed at which EPT will lose sync and indicate [CrankStalled](#)

Units: RPM

Detail: A crankshaft speed less than [StallSpeed](#) causes the engine speed to indicate zero, [CrankStalled](#) to indicate **STALLED**, and [EngineStatus](#) to indicate **STALLED**.

17 CrankRunThreshold

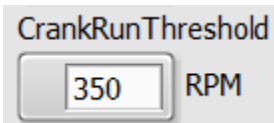

Tip Strip: Engine speed which determines [EngineStatus=RUNNING](#)

Units: RPM

Detail: The engine speed threshold used to differentiate the [EngineStatus](#) between **CRANKING** and **RUNNING**.

18 MissedCrankFlag



Tip Strip: Indicates that not enough crank pulses were received for complete engine cycle

Detail: Set to **FAULT** upon the detection of a pattern-specific crank feature while the [CrankCount](#) value has not yet reached the expected value.

Encoder Patterns: Indicates **FAULT** when an EncZ rising edge occurs before the expected number of Crank teeth have been counted.

N-M Patterns: Indicates **FAULT** when a gap occurs before the expected number of Crank teeth have been counted.

N+1 Patterns: Indicates **FAULT** when a Plus1 tooth occurs before the expected number of Crank teeth have been counted.

The **FAULT** condition causes a loss of sync. Re-sync is not allowed until the flag is cleared by pressing the [SyncFlagClear](#) button.

19 MissedGapFlag



Tip Strip: Indicates that the crank gap was not detected when expected

Detail: This indicator only applies to [N-M patterns](#). Indicates **FAULT** when an excess number of crank teeth are counted before the gap is detected. In other words, physical teeth are received at the location where a gap is expected. This condition causes a loss of sync. Re-sync is not allowed until the flag is cleared by pressing the [SyncFlagClear](#) button.

20 MissedCamFlag



Tip Strip: Indicates that the [EncZ](#) rising edge was not detected when expected

Detail: This indicator only applies to encoder patterns. Indicates **FAULT** when an excess number of crank teeth are counted before the [EncZ](#) rising edge occurs.

This condition causes a loss of sync. Re-sync is not allowed until the flag is cleared by pressing the [SyncFlagClear](#) button.

21 MissedPlus1Flag



Tip Strip: Indicates that the crank Plus1 pulse was not detected when expected

Detail: This indicator only applies to [N+1 patterns](#). Indicates **FAULT** when an excess number of crank teeth are counted before the Plus1 tooth is detected. In other words, evenly spaced teeth are received at the location where a Plus1 tooth is expected. This condition causes a loss of sync. Re-sync is not allowed until the flag is cleared by pressing the [SyncFlagClear](#) button.

22 AutoClearFlagWhileCranking

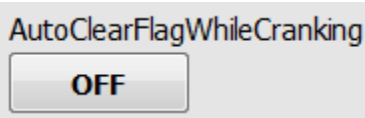

Tip Strip: Auto-clears EPT errors during [EngineStatus=CRANKING](#)

Detail: Sometimes, as the engine stops, the crankshaft may spin in a way that causes an erroneous loss of sync as the crankshaft comes to a rest and a fault flag will be set. This can often be prevented by increasing the [StallSpeed](#) value. However, if an EPT fault flag is set when the engine stops, the DI Driver System can optionally automatically clear any EPT fault flags during the next cranking of the engine for starting. When this button is **ON**, then EPT error flags will be automatically cleared while [EngineStatus](#) indicates **CRANKING**.

23 CamOffsetEnable

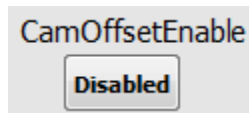

Tip Strip: Enables the cam signal to be offset by a specified number of crank pulses

Detail: The DI Driver System provides an optional offset function applied to the cam signal selected by [CamSelect](#). The offset function offsets the cam signal by the number of crank teeth specified by [CamOffset](#). The starting reference for the offset is the rising edge of the cam signal input to the function. The resulting offset cam signal will have a width equal to one crank tooth period. The offset cam signal will go high at the falling edge of the crankshaft signal immediately following the specified [CamOffset](#) number of rising edges of the crank signal. The offset cam signal will go low at the following rising edge of the crank signal. The resulting signal may need to be extended. The input to the cam offset function is from the digital input assigned to the Cam1 or Cam2 signal via the [Digital Input Setup](#) window. The output of the cam offset function is delivered to the cam extension function. When **Enabled**, the cam signal is offset. When **Disabled**, the camshaft signal is unaltered. The offset and the extended cam signals may be monitored in the [EPT Diagnostics](#) tab.

24 CamOffset



Tip Strip: Specifies the number of crank pulses to offset the cam pulse

Units: pulses

Detail: The DI Driver System provides an optional offset function applied to the cam signal selected by [CamSelect](#). The offset function offsets the cam signal by the number of crank teeth specified by [CamOffset](#). The starting reference for the offset is the rising edge of the cam signal input to the function. The resulting offset cam signal will have a width equal to one crank tooth period. The offset cam signal will go high at the falling edge of the crankshaft signal immediately following the specified [CamOffset](#) number of rising edges of the crank signal. The offset cam signal will go low at the following rising edge of the crank signal. The resulting signal may need to be extended. The input to the cam offset function is from the digital input assigned to the Cam1 or Cam2 signal via the [Digital Input Setup](#) window. The output of the [CamOffset](#) function is delivered to the [CamExtension](#) function. The offset and the extended cam signals may be monitored in the [EPT Diagnostics](#) tab.

25 CamExtEnable

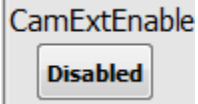

Tip Strip: Enables the cam signal to be extended by a specified number of crank pulses

Detail: The DI Driver System provides an optional extension function applied to the cam signal selected by [CamSelect](#). The extension function extends the cam signal by the number of crank teeth specified by [CamExtension](#). The starting reference for the extension is the rising edge of the cam signal input to the function. Therefore, the resulting extended cam signal will be shorter than the input cam signal if the [CamExtension](#) value is shorter than the cam input signal. The input to the [CamExtension](#) function is from the output of the [CamOffset](#) function. The output of the cam extension function is delivered to the [EncZMask](#) function for encoder patterns, and delivered directly to the EPT function for [N-M and N+1 patterns](#). When **Enabled**, the cam signal is extended. When **Disabled**, the cam signal is unaltered. The offset and the extended cam signals may be monitored in the [EPT Diagnostics](#) tab.

26 CamExtension

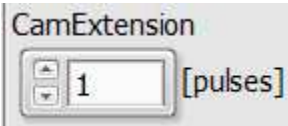

Tip Strip: Specifies the number of crank pulses to extend the cam pulse

Units: pulses

Detail: The DI Driver System provides an optional extension function applied to the cam signal selected by [CamSelect](#). The extension function extends the cam signal by the number of crank teeth specified by [CamExtension](#). The starting reference for the extension is the rising edge of the cam signal input to the function. Therefore, the resulting extended cam signal will be shorter than the input cam signal if the [CamExtension](#) value is shorter than the input signal. The input to the cam extension function is from the output of the cam offset function. The output of the cam extension function is delivered to the [EncZMask](#) function for encoder patterns, and delivered directly to the EPT function for [N-M and N+1 patterns](#). The offset and the extended cam signals may be monitored in the [EPT Diagnostics](#) tab.

27 CamHistory

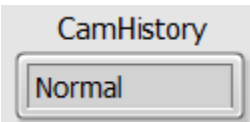

Tip Strip: Cam Signal Status

Detail: This parameter is only applicable to EPT types of [N-M and N+1](#). When the EPT is in sync, reports the state of the cam: **Normal**, **Error**, **Always High** or **Always Low**.

Normal: Indicated when the cam signal is alternating consistently between high and low upon each crank trigger wheel feature (M tooth gap or Plus1 tooth).

Error: Indicated when the cam signal is alternating between high and low, but not consistently upon each crank trigger wheel feature (M tooth gap or Plus1 tooth).

Always High: Indicated when the cam signal is constantly high upon each crank trigger wheel feature (M tooth gap or Plus1 tooth).

Always Low: Indicated when the cam signal is constantly low upon each crank trigger wheel feature (M tooth gap or Plus1 tooth).

An **Error** condition of the parameter does not cause a loss of sync.

28 CamSelect

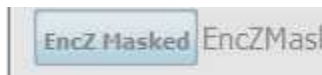

Tip Strip: Selects which Cam signal is used for EPT

Detail: The DI Driver System supports up to two cam signals for the purpose of variable valve timing control. For EPT [N-M and N+1 patterns](#), this setting toggles between the use of Cam1 or Cam2 for EPT synchronization. For EPT encoder patterns, this setting determines which cam signal is used for masking of the [EncZ](#) signal when an encoder is mounted to the crankshaft of a 4-STROKE engine.

29 EncZMask

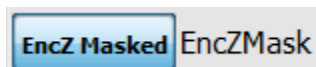

Tip Strip: Selects whether encoder Z signal is masked by the selected cam signal or passed directly to the EPT function

Detail: When set to **EncZ Masked**, the [EncZ](#) signal will be logically ANDed with the cam signal selected by [CamSelect](#). Therefore, the cam signal must be TRUE to allow the [EncZ](#) signal to pass through to the EPT. When set to **EncZ Passed**, the [EncZ](#) signal will always be passed through to the EPT, regardless of the cam signal level. Typically, when an encoder is mounted to the crankshaft of a 4-stroke engine, [EncZMask](#) should be set to **EncZ Masked**, and a cam phase signal must be used. When an encoder is mounted to the crankshaft of a 2-stroke engine, or mounted to the camshaft of a 4-stroke engine, [EncZMask](#) should be set to **EncZ Passed**, and a cam phase signal is not required.

30 Crank



Tip Strip: Indicates state of the crank signal

Detail: Indicates the logic level of the digital input assigned to the Crank signal in the [Digital Input Setup](#) window. This indicator is not updated at the same rate the signal is changing. It is for reference only.

31 Cam1



Tip Strip: Indicates state of the CAM signal

Detail: Indicates the logic level of the digital input assigned to the Cam1 signal in the [Digital Input Setup](#) window. This indicator is not updated at the same rate the signal is changing. It is for reference only.

32 Cam2



Tip Strip: Indicates state of the CAM signal

Detail: Indicates the logic level of the digital input assigned to the Cam2 signal in the [Digital Input Setup](#) window. This indicator is not updated at the same rate the signal is changing. It is for reference only.

33 EncZ



Tip Strip: Indicates state of the CAM signal

Detail: Indicates the logic level of the digital input assigned to the [EncZ](#) signal in the [Digital Input Setup](#) window. This indicator is not updated at the same rate the signal is changing. It is for reference only.

4.11.2 TDC Channel Mapping Tab



1 GlobalTDCOffset

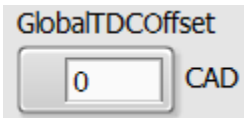

Tip Strip: Global TDC offset between absolute 0 and TDC1

Units: CAD

Detail: Crank angle degrees between the EPT absolute zero position and TDC1. When TDC1 is before EPT absolute zero position, then [GlobalTDCOffset](#) is negative. When TDC1 is after EPT absolute zero position, then [GlobalTDCOffset](#) is positive. The absolute zero position is specific to the [EPT pattern type](#).

2 TDCX

TDC1	0	CAD
TDC2	240	CAD
TDC3	480	CAD
TDC4	60	CAD
TDC5	300	CAD
TDC6	540	CAD
TDC7	120	CAD
TDC8	360	CAD
TDC9	600	CAD
TDC10	180	CAD
TDC11	420	CAD
TDC12	660	CAD

Tip Strip: Top Dead Center

Units: CAD

Detail: Crank angle degrees of offset between the TDC1 and TDCX, where X represents the cylinder number.

Typically, engine cylinder #1 will have a TDC of zero because the [GlobalTDCOffset](#) is used to specify CAD between absolute zero and TDC1. The other TDC parameters will have non-zero values, which specify the CAD spacing with respect to TDC1. TDC values are independent from any particular DI Driver or PFI Driver channel. The TDC values are mapped to a specific hardware driver channel using the [DIX-Y_TDC](#) and [PREFIX_TDC](#) drop-down list parameters.

3 DIX-Y_TDC

TDC1	DI1-1_TDC
TDC2	DI1-2_TDC
TDC3	DI1-3_TDC
TDC4	DI2-1_TDC
TDC5	DI2-2_TDC
TDC6	DI2-3_TDC
TDC7	DI3-1_TDC
TDC8	DI3-2_TDC
TDC9	DI3-3_TDC
TDC10	DI4-1_TDC
TDC11	DI4-2_TDC
TDC12	DI4-3_TDC

- ✓ TDC1
- TDC2
- TDC3
- TDC4
- TDC5
- TDC6
- TDC7
- TDC8
- TDC9
- TDC10
- TDC11
- TDC12

Tip Strip: Selects Top Dead Center reference associated with driver channel

Detail: TDC parameters are mapped to a specific DI Driver channel by selecting a [TDCX](#) from the drop-down list in each [DIX-Y_TDC](#) parameter, where X is the DI Driver module number and Y is the DI Driver channel number.

4 DIX_Firing_Window_Start / DIX_Firing_Window_End

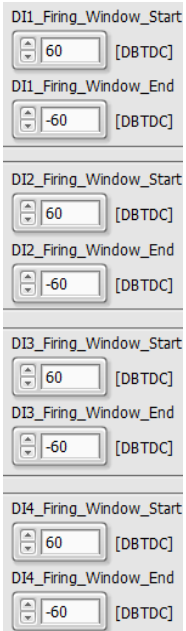

Tip Strip: Start of angle-based window around all injection events for a channel, End of angle-based window around all injection events for a channel

Units: DBTDC

Detail: The three channels within a DI Driver module share driver circuitry and are multiplexed. Only one channel within a DI Driver module is able to operate at one time. Therefore angle-based firing windows are used to define a period during which an injection event can take place for a given DI Driver channel. A firing window is created around each DI Driver channel, specified by a firing window start and end parameter for each DI Driver module. The firing window must not be greater than a span of 240 degrees, such that the firing windows around each of the three channels overlap. If the windows around each of the three DI Driver channels overlap, then the [Firing Window Overlap Detected](#) Indicator will be set **TRUE** and one or more of the three injector channels may not operate.

DIX_Firing_Window_Start: Defines the start of the window in Degrees Before Top Dead Center (DBTDC). The TDC reference for the window is the [TDCX](#) value associated with the applicable DI Driver module channel.

DIX_Firing_Window_End: Defines the end of the window in Degrees Before Top Dead Center (DBTDC). The TDC reference for the window is the [TDCX](#) value associated with the applicable DI Driver module channel.

5 Firing Window Overlap Detected

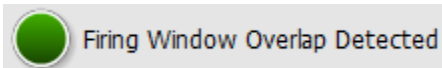

Tip Strip: Indicates that the firing window for one channel overlaps with the next multiplexed channel within the module

Detail: This indicator will be set to **TRUE** if any [firing window](#) overlap is detected in any of the channels within a single DI Driver or PFI Driver module.

6 PFI_TDC

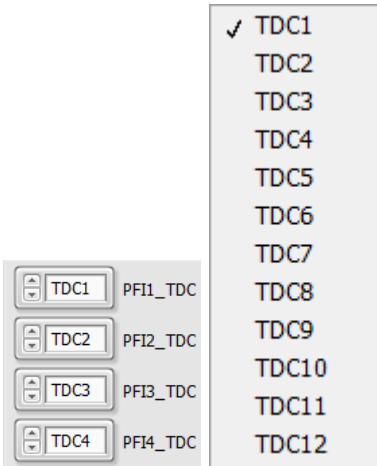

Tip Strip: Selects Top Dead Center reference associated with driver channel

Detail: TDC parameters are mapped to a specific PFI Driver channel by selecting a [TDCX](#) from the drop-down list in each [PFI_X_TDC](#) parameter, where X is the PFI Driver channel number.

7 PFI_Firing_Window_Start / PFI_Firing_Window_End

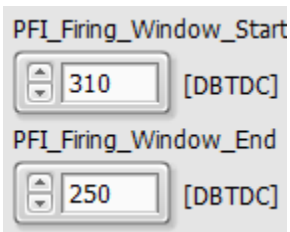

Tip Strip: Start of angle-based window around all injection events for a channel, End of angle-based window around all injection events for a channel

Units: DBTDC

Detail: The four PFI channels within the PFI Driver module share software functions and are multiplexed. Only one PFI channel within the PFI Driver module is able to operate at one time. Therefore, angle-based firing windows are used to define a period during which an injection event can take place for a given PFI channel. A firing window is created around each PFI channel, specified by a firing window start and end parameter for the PFI Driver module. The firing window must not be greater than a span of 180 degrees, such that the firing windows around each of the four channels overlap. If the windows around each of the four PFI channels overlap, then the [Firing Window Overlap Detected](#) Indicator will be set **TRUE** and one or more of the four injector channels may not operate.

PFI_Firing_Window_Start: Defines the start of the window in Degrees Before Top Dead Center (DBTDC). The TDC reference for the window is the [TDCX](#) value associated with the applicable PFI channel.

PFI_Firing_Window_End: Defines the end of the window in Degrees Before Top Dead Center (DBTDC). The TDC reference for the window is the [TDCX](#) value associated with the applicable PFI channel.

4.11.3 Cam Phase Capture Tab

The purpose of the Cam Phase Capture Tab is to configure the cam-capture function and monitor the captured rising edges of each cam signal. This function is designed for Variable Valve Actuation (VVA) control. The PFI Driver module lowside driver channels can be used to implement PID control of VVA oil control valves. The auxiliary PID functions can be used for this purpose and configured via the [Auxiliary PID Controller Setup](#) window. The auxiliary PID controller setpoint can be used to define the desired crank-angle location of the cam signal rising edge. The [CamX_RisingEdge](#) from this tab can be used as feedback to the PID control function.

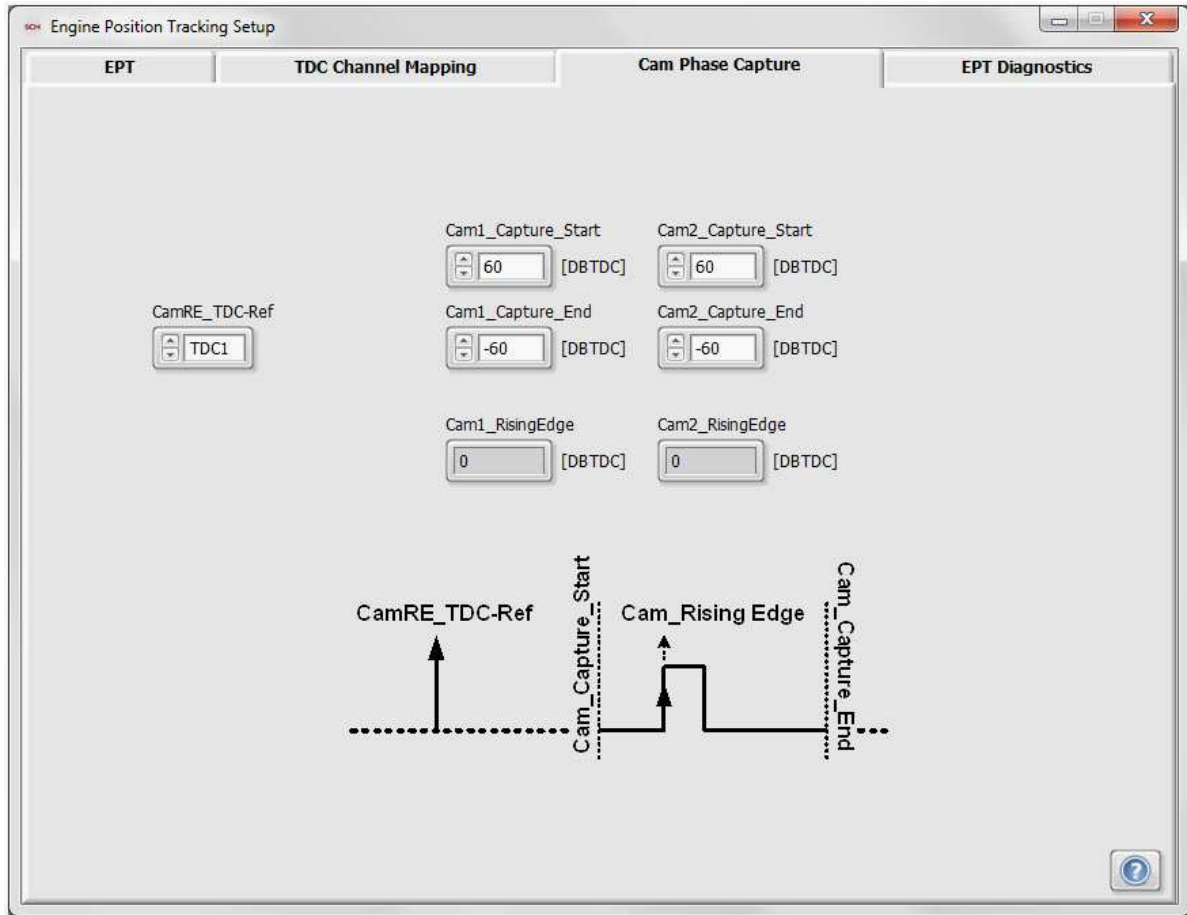

1 CamRE_TDC-Ref

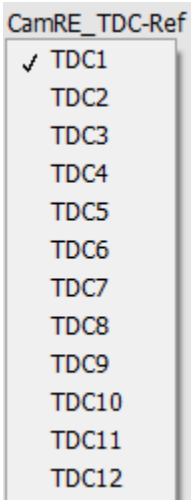

Tip Strip: Selects Top Dead Center reference associated with cam edge capturing

Detail: Selects the [TDCX](#) reference for the [CamX_Capture](#) window.

2 Cam1_Capture_Start

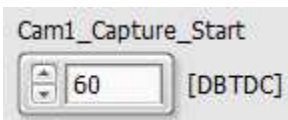

Tip Strip: Start of angle-based capture window for cam signal

Units: DBTDC

Detail: Defines the start of a window, with respect to the selected [TDCX](#), to search within for Cam1 rising edge.

3 Cam1_Capture_End

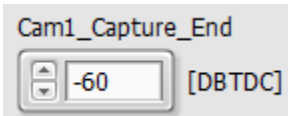

Tip Strip: End of angle-based capture window for cam signal

Units: DBTDC

Detail: Defines the end of a window, with respect to the selected [TDCX](#), to search within for Cam1 rising edge.

4 Cam1_RisingEdge

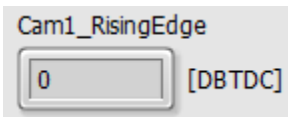

Tip Strip: Captured angle of rising cam edge

Units: DBTDC

Detail: The crank-angle location of a Cam1 signal rising edge, in Degrees Before TDC (DBTDC), captured in the window defined by [Cam1_Capture_Start](#) and [Cam1_Capture_End](#).

5 Cam2_Capture_Start

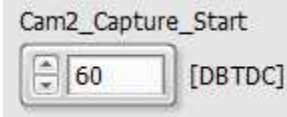

Tip Strip: Start of angle-based capture window for cam signal

Units: DBTDC

Detail: Defines the start of a window, with respect to the selected [TDCX](#), to search within for Cam2 rising edge.

6 Cam2_Capture_End

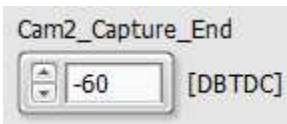

Tip Strip: End of angle-based capture window for cam signal

Units: DBTDC

Detail: Defines the end of a window, with respect to the selected [TDCX](#), to search within for Cam2 rising edge.

7 Cam2_RisingEdge

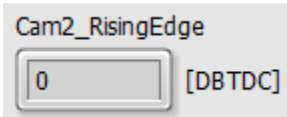

Tip Strip: Captured angle of rising cam edge

Units: DBTDC

Detail: The crank-angle location of a Cam2 signal rising edge, in Degrees Before TDC (DBTDC), captured in the window defined by [Cam2_Capture_Start](#) and [Cam2_Capture_End](#).

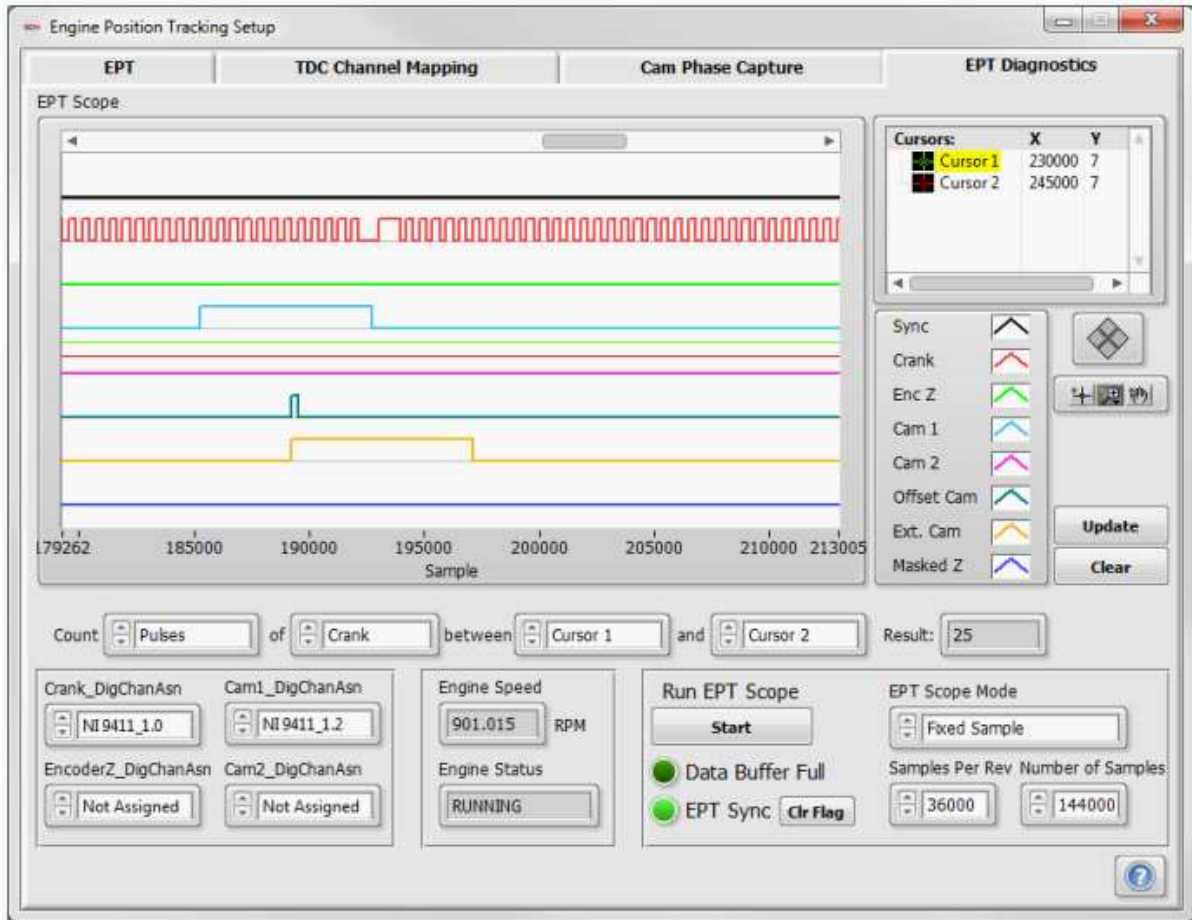

1 EPT Scope

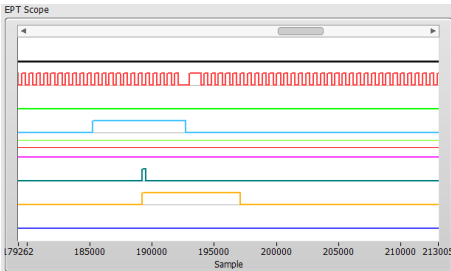

Tip Strip: Displays scope traces determined by setup

Units: Samples

Detail: Displays the logic level of each EPT function input.

2 Scope Controls

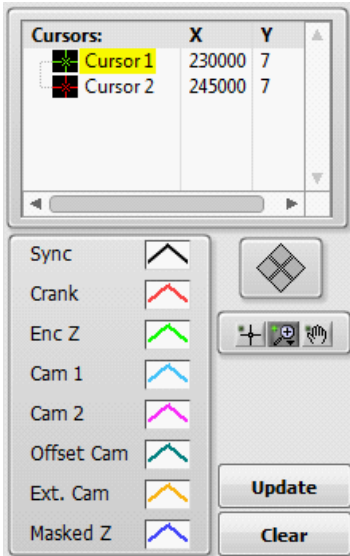

Tip Strip: Scope Controls, Update: Refreshes the [EPT scope](#) display, Clear: Clears the [EPT scope](#) display
 Detail: Used to manipulate the EPT Scope display and define cursors for measuring time and logic level of the various signals.

3 Scope Definitions

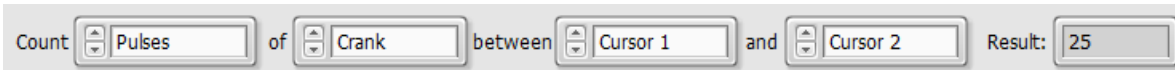

Tip Strip: Defines information to be shown on scope trace
 Detail: This collection of parameters is used to count pulses, rising edges, or falling edges of a specified signal between the cursors in the [EPT Scope](#).

4 Scope Channel Assignments

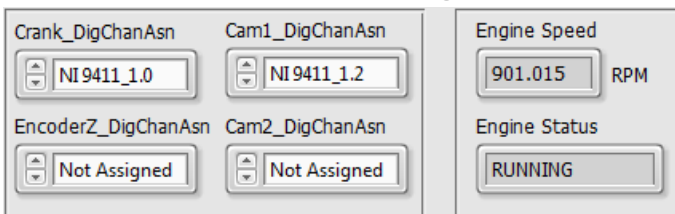

Tip Strip: Scope channel assignments
 Detail: The assignment controls are exact copies of the same controls within the [Digital Input Setup](#) window. The [EngineSpeed](#) and [EngineStatus](#) indicators are exact copies of the indicators on the EPT tab. These controls and indicators are placed here in duplicate for convenience.

5 Run EPT Scope

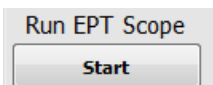

Tip Strip: Starts the [EPT scope](#)

Detail: When pressed, the EPT diagnostic function will begin to acquire EPT signals. While the acquisition is running this control can be pressed again to abort the acquisition.

6 Data Buffer Full

 Data Buffer Full

Tip Strip: Indicates data stream is too fast and some samples may have been lost

Detail: Indicates that the sampling rate is too fast for all samples to be recorded. This can happen if the engine speed and sampling rate specified in the [Scope Mode Options](#) are too high.

7 EPT Sync

 EPT Sync

Tip Strip: Indicates if the system is currently in sync, Clr Flag = Clears EPT errors

Detail: When **TRUE**, indicates that the EPT function is in sync. When **FALSE**, indicates that the EPT function is not in sync.

8 Scope Mode Options

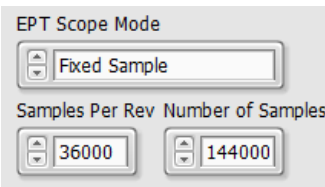

EPT Scope Mode

Samples Per Rev Number of Samples

Tip Strip: Defines amount and type of information to be displayed in scope trace

Detail: When set to **Fixed Sample**, the data acquisition will upon the press of [Run EPT Scope](#) and stop after the specified number of points is collected. The data will be displayed in the [EPT Scope](#) after pressing the **Update** control. When set to **Stop On Sync Stopped**, the data acquisition will begin filling the buffer upon the press of [Run EPT Scope](#) and continue acquiring data and purging the buffer until there is a loss of sync. Then the data acquisition will stop and the data will be displayed in the [EPT Scope](#) after pressing the **Update** control.

4.11.4 EPT Diagnostics Tab



1 EPT Scope

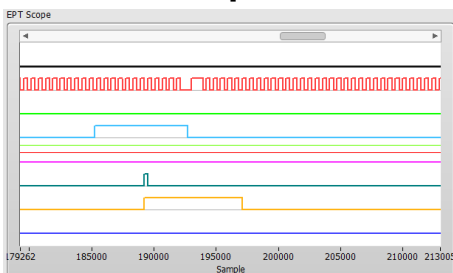

Tip Strip: Displays scope traces determined by setup
 Units: Samples
 Detail: Displays the logic level of each EPT function input.

2 Scope Controls

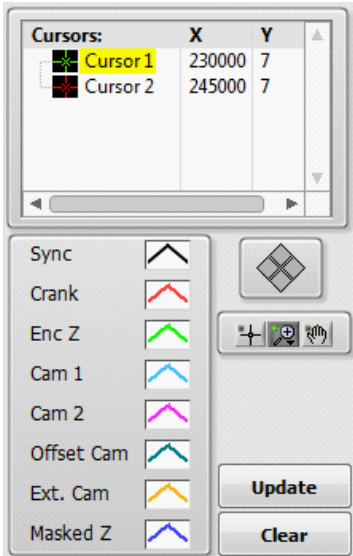

Tip Strip: Scope Controls, Update: Refreshes the [EPT scope](#) display, Clear: Clears the [EPT scope](#) display
 Detail: Used to manipulate the EPT Scope display and define cursors for measuring time and logic level of the various signals.

3 Scope Definitions

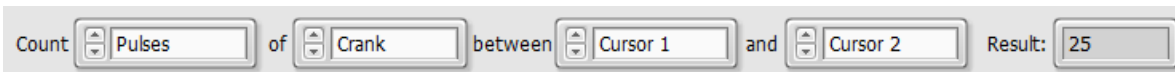

Tip Strip: Defines information to be shown on scope trace
 Detail: This collection of parameters is used to count pulses, rising edges, or falling edges of a specified signal between the cursors in the [EPT Scope](#).

4 Scope Channel Assignments

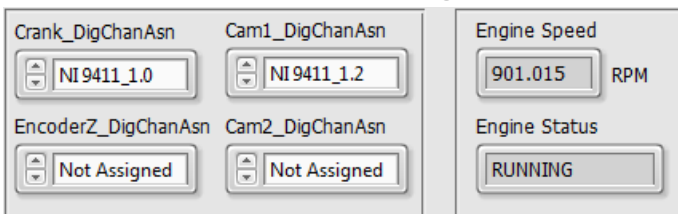

Tip Strip: Scope channel assignments
 Detail: The assignment controls are exact copies of the same controls within the [Digital Input Setup](#) window. The [EngineSpeed](#) and [EngineStatus](#) indicators are exact copies of the indicators on the EPT tab. These controls and indicators are placed here in duplicate for convenience.

5 Run EPT Scope

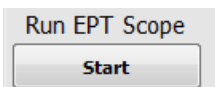

Tip Strip: Starts the [EPT scope](#)

Detail: When pressed, the EPT diagnostic function will begin to acquire EPT signals. While the acquisition is running this control can be pressed again to abort the acquisition.

6 Data Buffer Full

 Data Buffer Full

Tip Strip: Indicates data stream is too fast and some samples may have been lost

Detail: Indicates that the sampling rate is too fast for all samples to be recorded. This can happen if the engine speed and sampling rate specified in the [Scope Mode Options](#) are too high.

7 EPT Sync

 EPT Sync

Tip Strip: Indicates if the system is currently in sync, Clr Flag = Clears EPT errors

Detail: When **TRUE**, indicates that the EPT function is in sync. When **FALSE**, indicates that the EPT function is not in sync.

8 Scope Mode Options

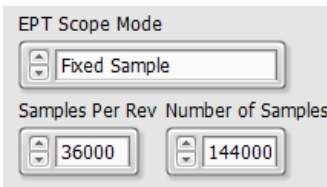

Tip Strip: Defines amount and type of information to be displayed in scope trace

Detail: When set to **Fixed Sample**, the data acquisition will upon the press of [Run EPT Scope](#) and stop after the specified number of points is collected. The data will be displayed in the [EPT Scope](#) after pressing the **Update** control. When set to **Stop On Sync Stopped**, the data acquisition will begin filling the buffer upon the press of [Run EPT Scope](#) and continue acquiring data and purging the buffer until there is a loss of sync. Then the data acquisition will stop and the data will be displayed in the [EPT Scope](#) after pressing the **Update** control.

4.13 Calibration Mode Setup Window

The purpose of the Calibration Mode Setup window is to configure a series of uniform injection command pulses to the enabled channel of each DI Driver module. Only one channel of each DI Driver may be enabled at a time, otherwise no commands will be delivered to a module with multiple channels enabled. This window is only applicable when one or more DI Driver Driver modules are configured for Calibration mode.

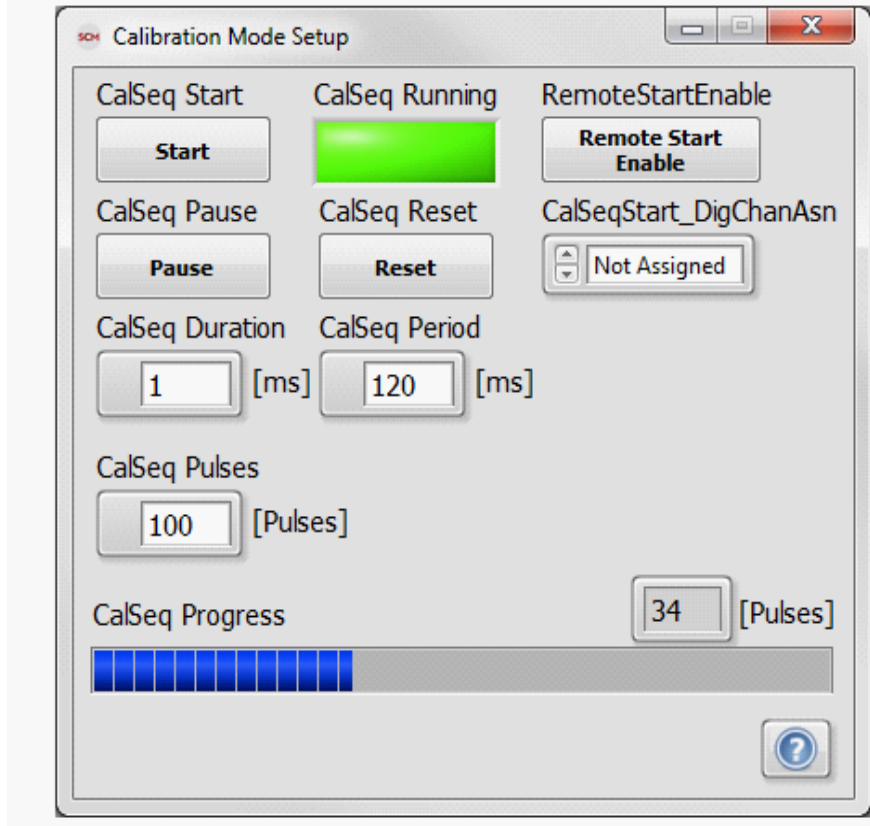

1 CalSeq Start

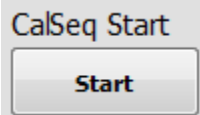

Tip Strip: Starts the specified pulse sequence

Detail: When pressed, starts delivering the number of injection command pulses specified by [CalSeq Pulses](#), according to the specified [CalSeq Period](#) and [CalSeq Duration](#).

2 CalSeq Pause

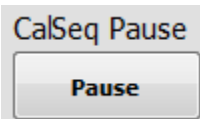

Tip Strip: Pauses calibration sequence

Detail: When pressed, pauses the delivery of the specified injection command sequence. When depressed, continues the command sequence at the paused location. Pausing the sequence will allow any active injection command to complete.

3 CalSeq Reset

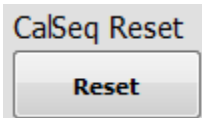

Tip Strip: Resets calibration sequence

Detail: When pressed, resets the internal pulse counter to zero.

4 CalSeq Running

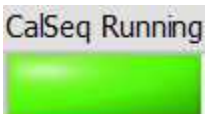

Tip Strip: Indicates sequence status

Detail: Indicates the running status of the injection command sequence.

5 CalSeq Duration

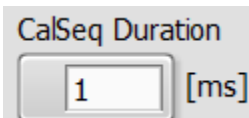

Tip Strip: Duration of injection pulses

Units: msec

Detail: Pulse width of each pulse during a calibration sequence.

6 CalSeq Period

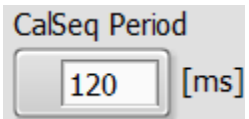

Tip Strip: Period between start of injection pulses

Units: msec

Detail: Time period between the rising edges of injection pulses during a calibration sequence.

7 CalSeq Pulses

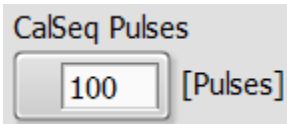

Tip Strip: Number of pulses for calibration sequence

Units: Pulses

Detail: Number of injection pulses to be commanded during a calibration sequence.

8 RemoteStartEnable



Tip Strip: Enables remote start through External Digital Trigger

Detail: Enables remote start through an external digital trigger configured by [CalSeqStart_DigChanAsn](#).

9 CalSeqStart_DigChanAsn

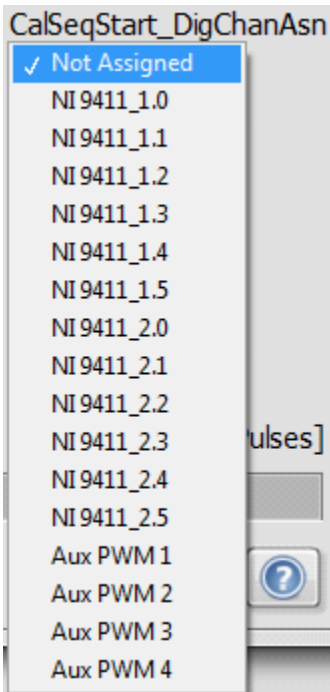

Tip Strip: Selects the digital signal used for triggering the calibration sequence.

Detail: Allows the user to select an external digital signal for triggering the start of the calibration sequence.

10 CalSeqProgress

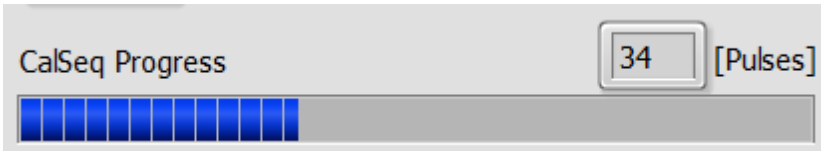

Tip Strip: Indicates sequence progress

Detail: Indicates the progress through the calibration sequence. The progress bar fill rate is automatically adjusted for the value of [CalSeq Pulses](#).

4.14 Expansion Calibration Mode Setup Window

The purpose of the Calibration Mode Setup window is to configure a series of uniform injection command pulses to the enabled channel of each PFI Driver module. Only one channel of each PFI Driver may be enabled at a time, otherwise no commands will be delivered to a module with multiple channels enabled. This window is only applicable when one or more PFI Driver modules are configured for Calibration mode.

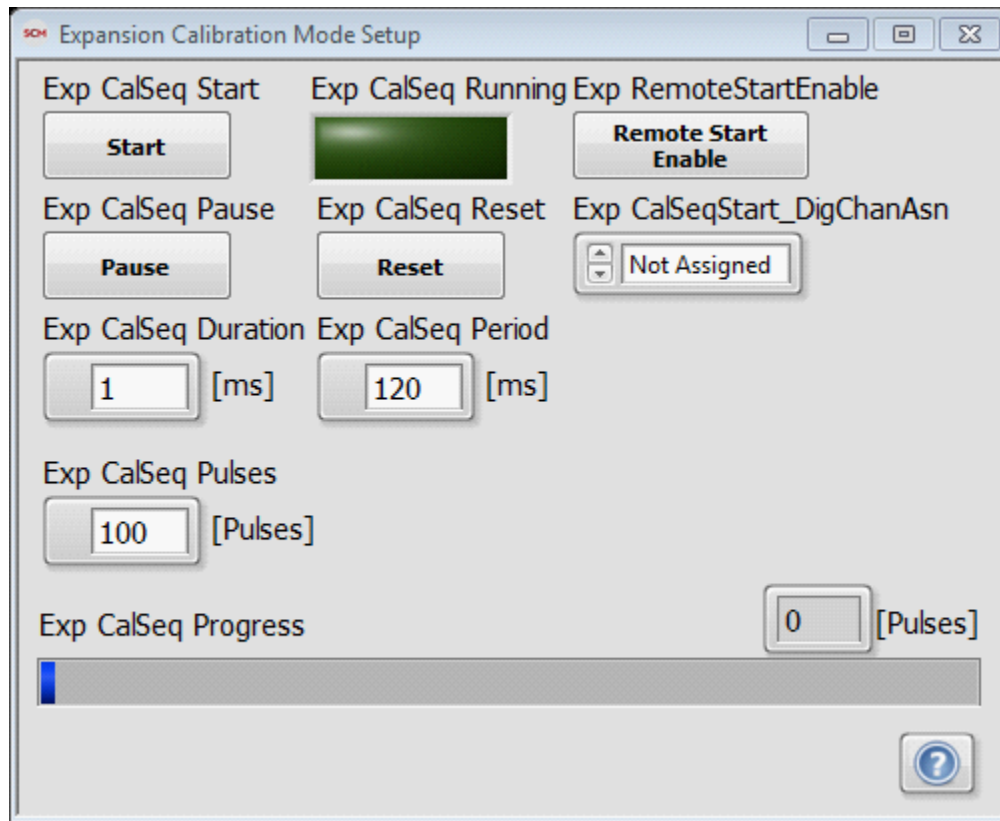

1 Exp CalSeq Start

Exp CalSeq Start



Tip Strip: Starts the specified pulse sequence

Detail: When pressed, starts delivering the number of injection command pulses specified by [Exp CalSeq Pulses](#), according to the specified [Exp CalSeq Period](#) and [Exp CalSeq Duration](#).

2 Exp CalSeq Pause

Exp CalSeq Pause

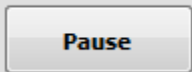

Tip Strip: Pauses calibration sequence

Detail: When pressed, pauses the delivery of the specified injection command sequence. When depressed, continues the command sequence at the paused location. Pausing the sequence will allow any active injection command to complete.

3 Exp CalSeq Reset

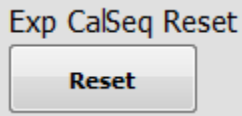

Tip Strip: Resets calibration sequence

Detail: When pressed, resets the internal pulse counter to zero.

4 Exp CalSeq Running

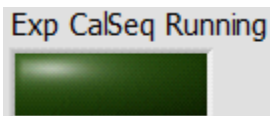

Tip Strip: Indicates sequence status

Detail: Indicates the running status of the injection command sequence.

5 Exp CalSeq Duration

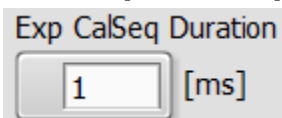

Tip Strip: Duration of injection pulses

Units: msec

Detail: Pulse width of each pulse during a calibration sequence.

6 Exp CalSeq Period

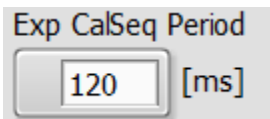

Tip Strip: Period between start of injection pulses

Units: msec

Detail: Time period between the rising edges of injection pulses during a calibration sequence.

7 Exp CalSeq Pulses

Exp CalSeq Pulses

 [Pulses]

Tip Strip: Number of pulses for calibration sequence

Units: Pulses

Detail: Number of injection pulses to be commanded during a calibration sequence.

8 Exp RemoteStartEnable

Exp RemoteStartEnable

Tip Strip: Enables remote start through External Digital Trigger

Detail: Enables remote start through an external digital trigger configured by [Exp CalSeqStart_DigChanAsn](#).

9 Exp CalSeqStart_DigChanAsn

Exp CalSeqStart_DigChanAsn

- ✓ Not Assigned
- NI9411_3.0
- NI9411_3.1
- NI9411_3.2
- NI9411_3.3
- NI9411_3.4
- NI9411_3.5
- VR/Hall_1
- VR/Hall_2
- VR/Hall_3
- VR/Hall_4
- VR/Hall_5
- VR/Hall_6
- Aux: PWM 5
- Aux: PWM 6
- Aux: PWM 7
- Aux: PWM 8

Tip Strip: Selects the digital signal used for triggering the calibration sequence.

Detail: Allows the user to select an external digital signal for triggering the start of the calibration sequence.

10 Exp CalSeqProgress

Exp CalSeq Progress

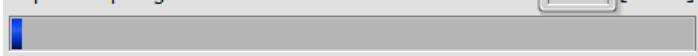
 [Pulses]

Tip Strip: Indicates sequence progress

Detail: Indicates the progress through the calibration sequence. The progress bar fill rate is automatically adjusted for the value of [Exp CalSeq Pulses](#).

4.15 Direct Mapping

The direct mapping feature allows users to directly map DI Driver System inputs and [User Variables](#) to Flex Control Parameters. The input values correspond to the input parameter as specified in [DirectMap_X_InputSelector](#). The direct mapping output is routed to the Flex Control Parameters selected in [DirectMap_X_FlexControlParameters](#). The Flex Control Parameters are a list of many controls from the various setup windows of the DI Driver System. When a Flex Control Parameter is selected here, the value from the [DirectMap_X_InputSelector](#) will overwrite that parameter. The Direct Map function is only active when it is enabled via [Enable DirectMap_X button](#).

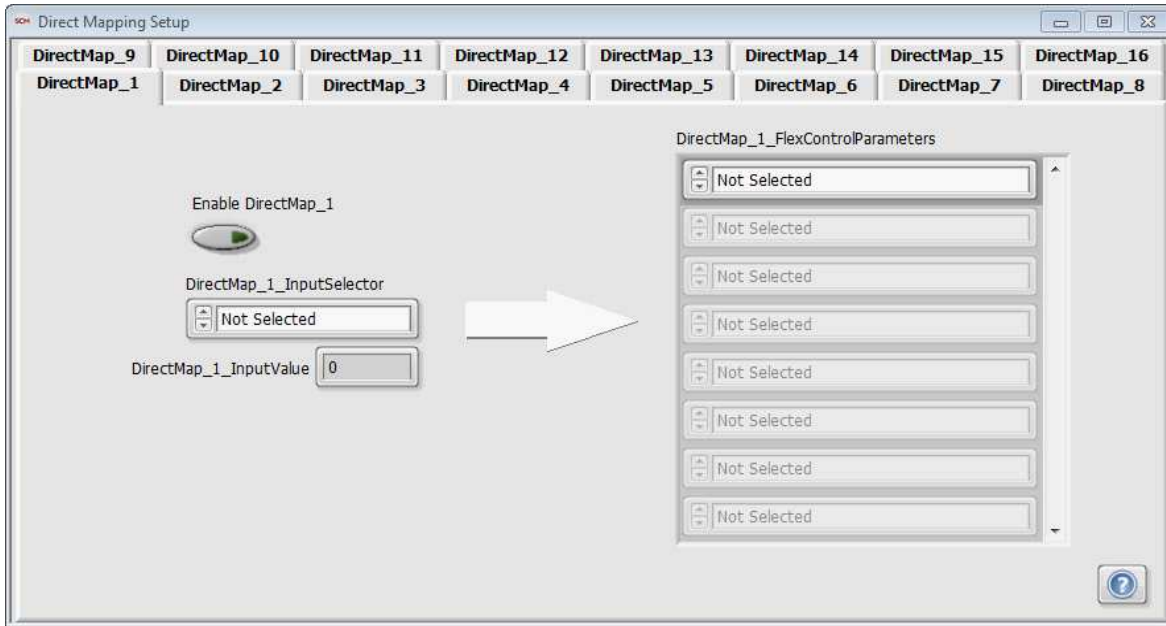

1 Enable DirectMap_X



Tip Strip: Enables DirectMap_X

Detail: When **ON** the direct mapping is enabled and the selected Flex Control Parameters will be overwritten by the direct mapping input.

2 DirectMap_X_InputSelector

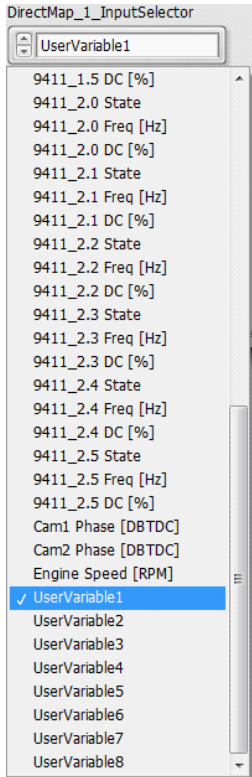

Tip Strip: Assigns signal source to the Flex Control Parameter array

Detail: Drop-down selection control for selecting the input parameter for direct mapping. The available parameters for selection are analog inputs, battery voltage, digital input parameters, cam phase, engine speed, and user variables.

3 DirectMap_X_InputValue

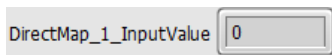

Tip Strip: Shows the value of the selected direct mapping input

4 DirectMap_X_FlexControlParameters

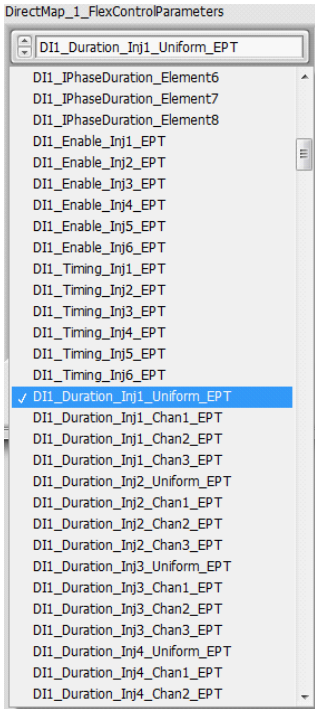

Tip Strip: Selects destination of the direct mapping input

Detail: Array of Flex Control Parameter selectors. Each selector maps the [DirectMap_X_InputSelector](#) to a Flex Control Parameter. The selected parameter will be overwritten by the [DirectMap_X_InputSelector](#) value. The Flex Control Parameters can be selected one of two ways: by left unclicking and searching through the full list of Flex Control Parameters, shown above, or by right unclicking and searching through a hierarchical list of menus to find the particular Flex Control Parameter of interest, as shown below.

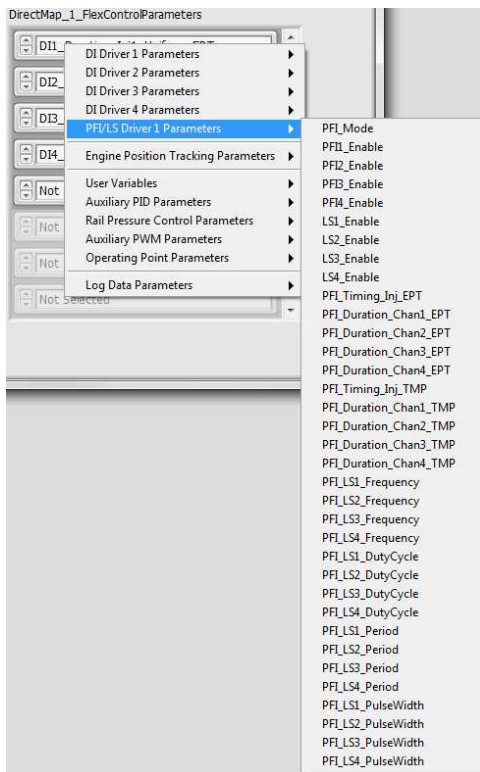

4.16 Table Setup Window

The purpose of the Table Setup window is to configure up to eight one-dimensional (1D) lookup tables and up to eight two-dimensional (2D) lookup tables for mapping input values to output values. A separate tab is utilized for each lookup table configuration. Each tab provides the ability to select from a variety of table input sources and assign the table output to an array of [Flex Control Parameter](#) destinations. Each lookup table can be individually enabled or disabled. The 1D lookup table function will perform a linear interpolation between the X indices which bound the X input value. The 2D lookup table function will perform a triple linear interpolation between the X and Y indices which bound the X and Y input values.

4.16.1 Table1D

A 1D lookup table control consists of a set of matching X and Y arrays. The X values correspond to the input parameter as specified in [Table1D_X_InputSelector](#). The 1D lookup table output is routed to the Flex Control Parameters selected in [Table1D_X_FlexControlParameters](#). The Flex Control Parameters are a list of many controls from the various setup windows of the DI Driver System. When a Flex Control Parameter is selected here, the value from the lookup table output will overwrite that parameter. The table is only active when it is enabled via [Enable Table1D_X](#) button.

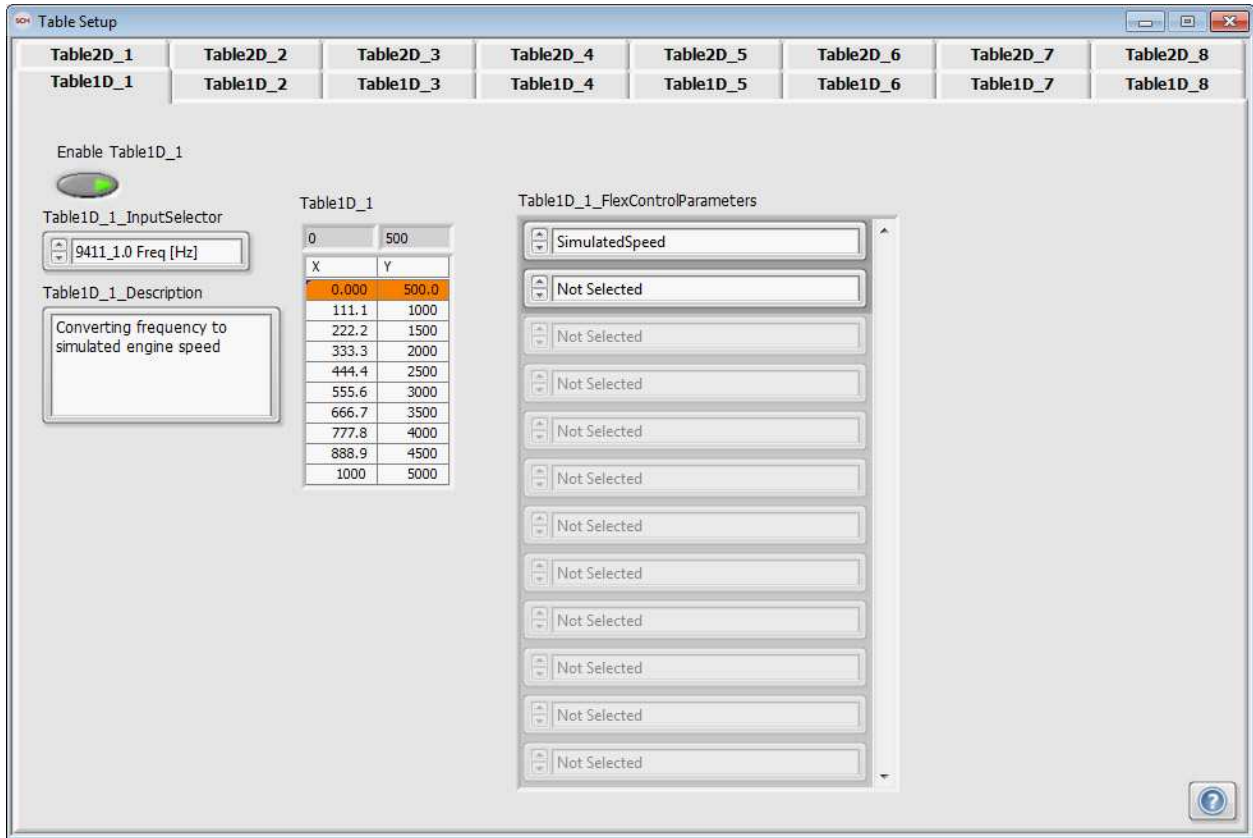

1 Enable Table1D_X



Tip Strip: Enables 1D Table

Detail: When **ON** the lookup table is enabled and the selected Flex Control Parameters will be overwritten by the lookup table output.

2 Table1D_X_InputSelector

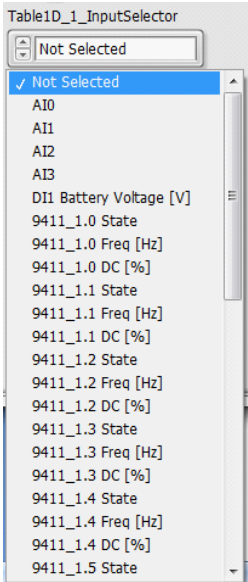

Tip Strip: Assigns signal source to the 1D lookup table X array

Detail: Drop-down selection control for selecting the input parameter for the X values of the lookup table. The available parameters for selection are analog inputs, battery voltage, digital input parameters, cam phase, engine speed, and user variables.

3 Table1D_X_Description

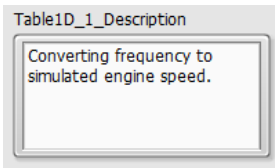

Detail: Text field for entering a lookup table description.

4 Table1D_X

0		500	
X	Y		
100.0	500.0		
200.0	555.6		
300.0	1111		
400.0	1667		
500.0	2222		
600.0	2778		
700.0	3333		
800.0	3889		
900.0	4444		
1000	5000		

Tip Strip: 1D conversion table

Detail: The X column is for input and the Y column is for the output conversion. Linear interpolation is done between the values.

5 Table1D_X_FlexControlParameters

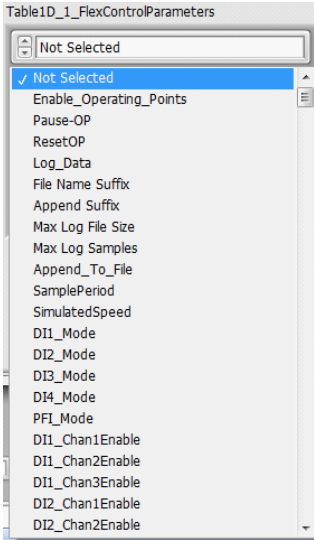

Tip Strip: Selects destination of the 1D lookup table output

Detail: Array of Flex Control Parameter selectors. Each selector maps the lookup table output to a Flex Control Parameter. The selected parameter will be overwritten by the lookup table output. The Flex Control Parameter can be selected one of two ways: by left unclicking and searching through the full list of Flex Control Parameters, shown above, or by right unclicking and searching through a hierarchical list of menus to find the particular Flex Control Parameter of interest, as shown in the [Direct Mapping Section](#).

4.16.2 Table2D

A 2D lookup table control consists of a set of X and Y 1D input arrays and a matching Z 2D output array. The X values correspond to the input parameter as specified in [Table2D_Xa_InputSelector](#). The Y values correspond to the input parameter as specified in [Table2D_Xb_InputSelector](#). The 2D lookup table Z output is routed to the Flex Control Parameters selected in [Table2D_X_FlexControlParameters](#). The Flex Control Parameters are a list of many controls from the various setup windows of the DI Driver System. When a Flex Control Parameter is selected here, the value from the lookup table output will overwrite that parameter. The table is only active when it is enabled via [Enable Table2D_X](#) button.

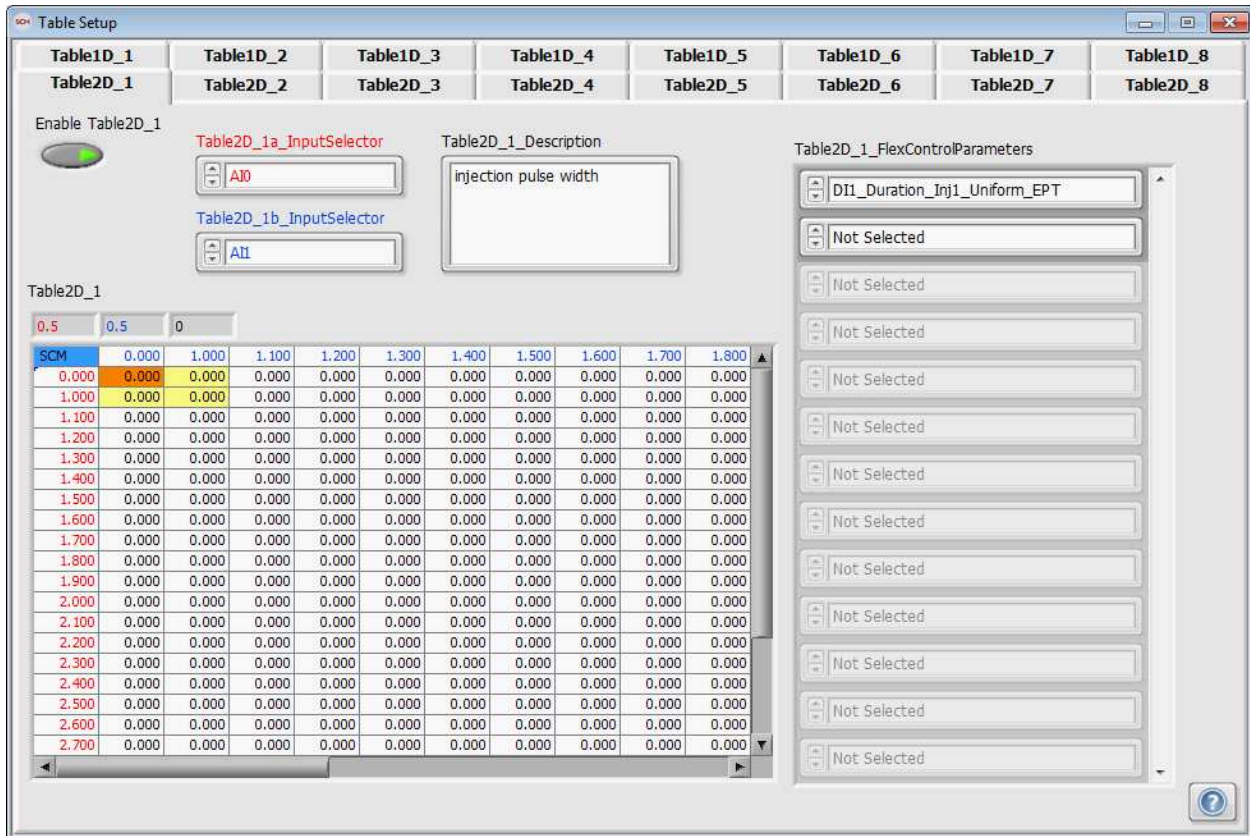

1 Enable Table2D_X



Tip Strip: Enables 2D Table

Detail: When **ON** the lookup table is enabled and the selected Flex Control Parameters will be overwritten by the lookup table output.

2 Table2D_Xa_InputSelector

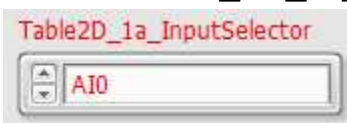

Tip Strip: Assigns signal source to the 2D lookup table X array

Detail: Drop-down selection control for selecting the input parameter for the X values of the lookup table. The available parameters for selection are analog inputs, battery voltage, digital input parameters, cam phase, engine speed, and user variables.

3 Table2D_Xb_InputSelector

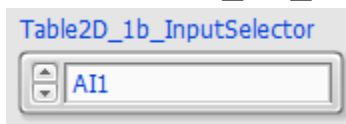

Tip Strip: Assigns signal source to the 2D lookup table Y array

Detail: Drop-down selection control for selecting the input parameter for the Y values of the lookup table. The available parameters for selection are analog inputs, battery voltage, digital input parameters, cam phase, engine speed, and user variables.

4 Table2D_X_Description

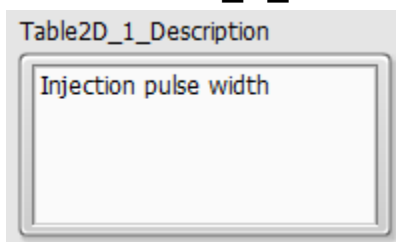

Detail: Text field for entering a lookup table description.

5 Table2D_X_FlexControlParameters

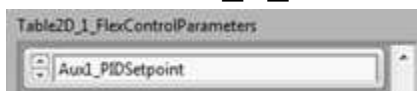

Tip Strip: Selects destination of the 2D lookup table output

Detail: Array of Flex Control parameter selectors. Each selector maps the lookup table output to a Flex Control Parameter. The selected parameter will be overwritten by the lookup table output. The Flex Control Parameter can be selected one of two ways: by left unclicking and searching through the full list of Flex Control Parameters, shown above, or by right unclicking and searching through a hierarchical list of menus to find the particular Flex Control Parameter of interest, as shown in the [Direct Mapping Section](#).

6 Table2D_X

Table2D_1

1.6 1.2 0.24305

SCM	0.2000	0.4000	0.6000	0.8000	1.000	1.200	1.400	1.600	1.800	2.000
0.2000	0.000	0.000	0.000	0.000	0.000	0.000	0.000	0.000	0.000	0.000
0.4000	0.000	0.00694	0.01388	0.02082	0.02776	0.03470	0.04164	0.04858	0.05552	0.06246
0.6000	0.000	0.01388	0.02776	0.04164	0.05552	0.06940	0.08328	0.09716	0.11104	0.12492
0.8000	0.000	0.02082	0.04164	0.06246	0.08328	0.10410	0.12492	0.14574	0.16656	0.18738
1.000	0.000	0.02776	0.05552	0.08328	0.11104	0.13880	0.16656	0.19432	0.22208	0.24984
1.200	0.000	0.03470	0.06940	0.10410	0.13880	0.17350	0.20820	0.24290	0.27760	0.31230
1.400	0.000	0.04164	0.08328	0.12492	0.16656	0.20820	0.25000	0.29174	0.33348	0.37522
1.600	0.000	0.04858	0.09716	0.14574	0.19432	0.24310	0.29174	0.34038	0.38896	0.43754
1.800	0.000	0.05552	0.11104	0.16656	0.22208	0.27760	0.33312	0.38864	0.44416	0.50000
2.000	0.000	0.06246	0.12492	0.18738	0.25000	0.31250	0.37500	0.43750	0.50000	0.56250

Tip Strip:2D lookup table

Detail: The left most X column (red) and the top Y row (blue) are for input. The 2D Z table values are triple interpolated to generate the lookup table output.

4.17 Auxiliary PID Controller Setup Window

The purpose of the Auxiliary PID Controller Setup window is for configuring up to eight general purpose Proportional-Integral-Derivative (PID) controller functions for commanding a variety of Flex Control Parameters. The purpose of a PID controller is to manipulate a final output parameter in such a way that the error between the PID setpoint and the process variable is zero. The process variable for each PID controller can be sourced from a variety of inputs to the system. The setpoint for each PID controller can be entered manually or overwritten by [lookup table outputs](#) or [operating points](#). Each PID controller has proportional gain, integral time, and derivative time for specifying PID output behavior. The PID controller function output is added to a Feed-Forward parameter to produce a final output value to be mapped to a Flex Control Parameter. The Feed-Forward can be entered manually or overwritten by lookup table outputs or operating points. While PID operation is enabled, the final output value can be overridden by a manual entry for debug purposes. Each PID controller can be monitored within a dedicated plot window to assist with PID tuning. This document does not discuss the detailed theory of PID control. However, the general PID equation used for PID control within this system is according to:

$$PID\ Output = [Kc \cdot e(t)] + \left[\left(\frac{Kc}{Ti} \right) \cdot \int e(t) dt \right] + \left[(Kc \cdot Td) \cdot \frac{dPV}{dt} \right]$$

Where:

PV = Process Variable

e(t) = Error (Setpoint – Process Variable) as a function of time

Kc = Proportional gain

Ti = Integral time constant

Td = Derivative time constant

$\int e(t)$ = Integral of error as a function of time

There are many internet articles and books available covering PID control theory. One recommended internet resource for PID control theory is at <http://www.ni.com/white-paper/3782/en>. The core of the DI Driver System PID control function is very similar to the LabVIEW code described in the above recommended article. This document assumes that the reader understands the purpose of PID setpoints, CalPoints, and gains.

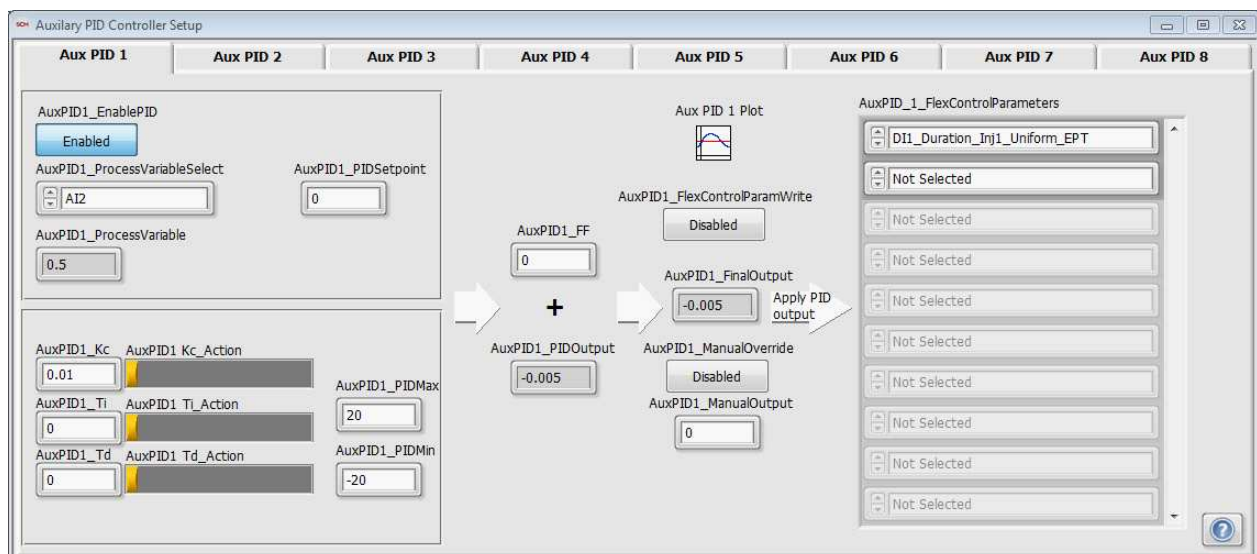

1 AuxPIDX_EnablePID

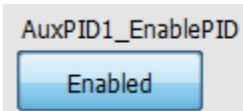

Tip Strip: Enables PID controller function

2 AuxPIDX_ProcessVariableSelect

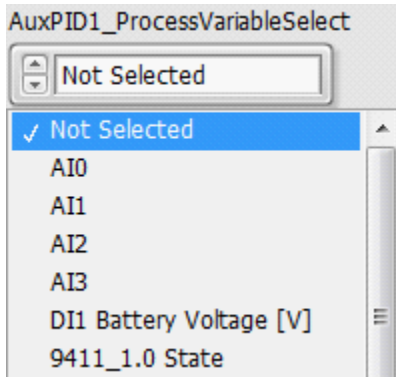

Tip Strip: Select feedback variable for PID control

Detail: Drop-down selection control for selecting the process variable input for the PID controller. The available parameters for selection are analog inputs, battery voltage, digital input parameters, cam phase, engine speed, and user variables.

3 AuxPIDX_ProcessVariable

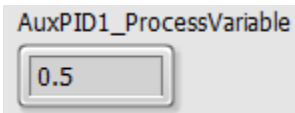

Tip Strip: Feedback value to PID controller

Units: Same as Process Variable (Could be V, bar, RPM, etc.)

Detail: Displays current value of the parameter selected in [AuxPIDX_ProcessVariableSelect](#).

4 AuxPIDX_PIDSetpoint

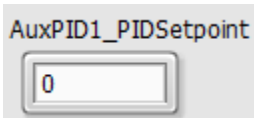

Tip Strip: PID controller setpoint

Detail: The control setpoint to the Aux PID X function. This parameter can be manually entered or overwritten by [lookup table outputs](#) or [operating points](#).

5 AuxPIDX_Kc

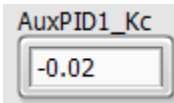

Tip Strip: PID proportional gain

Detail: Proportional gain. A value of zero disables proportional, integral, and derivative contributions to the PID output. (See the equation above for reference.) Smaller values cause less proportional contribution to the PID output. Larger values cause more proportional contribution to the PID output. Negative values will generate PID outputs that are inversely proportional to the error (Setpoint – Process Variable).

6 AuxPIDX Kc_Action

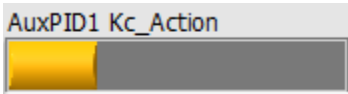

Tip Strip: Proportional contribution of PID controller

Detail: Indicates the contribution of the proportional term to the total PID output.

7 AuxPIDX_Ti

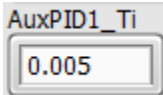

Tip Strip: Integral time constant for PID controller (lower = stronger action. 0 = disabled.)

Detail: Integral time constant. A value of zero disables integral contribution to the PID output. Smaller non-zero values cause more contribution to the PID output. Larger values cause less contribution to the PID output. Negative values should not be used.

8 AuxPIDX Ti_Action

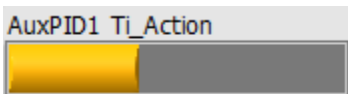

Tip Strip: Integral contribution of PID controller

Detail: Indicates the contribution of the integral term to the total PID output.

9 AuxPIDX_Td

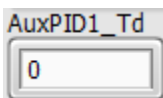

Tip Strip: Derivative time constant for PID controller (higher = stronger action. 0 = disabled.)

Detail: Derivative time constant. A value of zero disables derivative contribution to the PID output. Smaller values cause less contribution to the PID output. Larger values cause more contribution to the PID output. Negative values should not be used.

10 AuxPIDX Td_Action

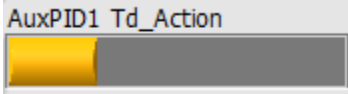

Tip Strip: Derivative contribution of PID controller

Detail: Indicates the contribution of the derivative term to the total PID output.

11 AuxPIDX_PIDMax

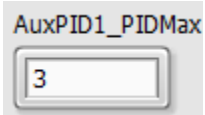

Tip Strip: PID output maximum limit (before feed forward is added)

Detail: Maximum output allowed from the PID controller.

12 AuxPIDX_PIDMin

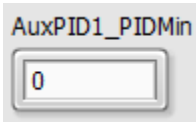

Tip Strip: PID output minimum limit (before feed forward is added)

Detail: Minimum output allowed from the PID controller.

13 AuxPIDX_FF

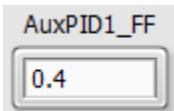

Tip Strip: Feed forward value added to PID output. Result placed in PID final output.

Detail: Feed forward value that is added to the PID output value. The result is placed in [AuxPID1_FinalOutput](#).

14 AuxPIDX_PIDOutput

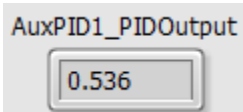

Tip Strip: PID controller output (before feed forward is added)

Detail: Output value from the PID controller. This value is limited by the values in [AuxPIDX_PIDMin](#) and [AuxPIDX_PIDMax](#). This value is added to [AuxPIDX_FF](#) and the result is placed in [AuxPIDX_FinalOutput](#).

15 Aux PID X Plot

Aux PID 1 Plot



Tip Strip: Launches a plot displaying [AuxPIDX_ProcessVariable](#), [AuxPIDX_PIDSetpoint](#) and [AuxPIDX_FinalOutput](#).

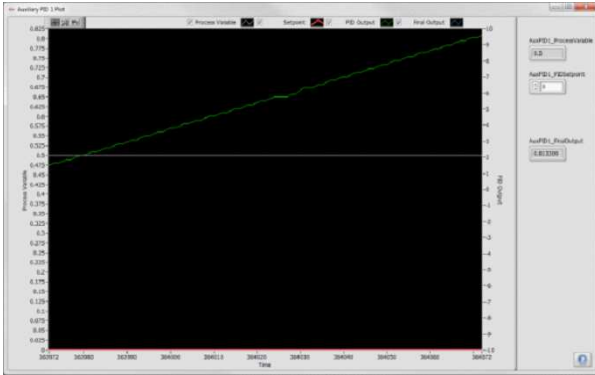

16 AuxPID1_FlexControlParamWrite

AuxPID1_FlexControlParamWrite

Disabled

Tip Strip: Enables writing of PID final output to selected Flex Control Parameters

Detail: When **Enabled**, enables the writing of the [AuxPIDX_FinalOutput](#) value to the array of selected Flex Control Parameters in [AuxPID_X_FlexControlParam](#).

17 AuxPIDX_FinalOutput

AuxPID1_FinalOut

0.936

Tip Strip: Result of PID output + PID feed forward

Units: %

Detail: Displays the result of [AuxPIDX_FF](#) added to [AuxPIDX_PIDOutput](#).

18 AuxPIDX_ManualOverride

AuxPID1_ManualOverride

Disabled

Detail: When **Enabled**, causes [AuxPIDX_ManualOutput](#) to override [AuxPIDX_FinalOutput](#).

19 AuxPIDX_ManualOutput

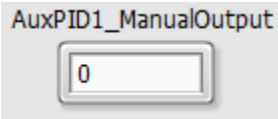

Units: %

Detail: Value to override [AuxPIDX_FinalOutput](#) when [AuxPIDX_ManualOverride](#) is **Enabled**.

20 AuxPID_X_FlexControlParam

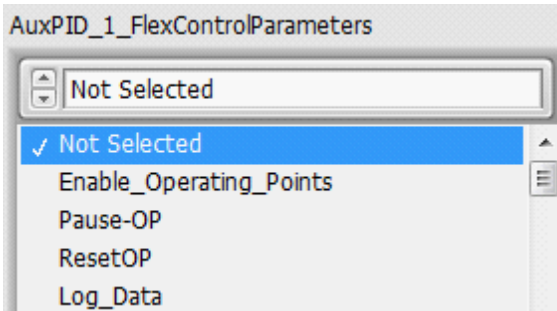

Tip Strip: Select flex control parameters to be controlled by this PID control

Detail: Array of Flex Control Parameter selectors. Each selector maps the [AuxPIDX_FinalOutput](#) value to a Flex Control Parameter. The selected parameter will be overwritten by the [AuxPIDX_FinalOutput](#). The Flex Control Parameter can be selected one of two ways: by left unclicking and searching through the full list of Flex Control Parameters, shown above, or by right unclicking and searching through a hierarchical list of menus to find the particular Flex Control Parameter of interest, as shown in the [Direct Mapping Section](#).

4.18 Rail Pressure Control Setup Window

The purpose of the Rail Pressure Control (RPC) Setup window, is to configure a dedicated direct injection common-rail fuel pressure control function. The function writes to the optional PFI Driver 1 module lowside driver channels which are connected to a high pressure pump Inlet Metering Valve (IMV) and a High Pressure Valve (HPV) on the rail. The RPC function implements two PID controllers; one for RPC via the IMV, and one for RPC via the HPV. Only one PID controller may be enabled at one time, either for IMV PID or HPV PID. While IMV PID is enabled, the HPV must be controlled via constant PWM duty cycle. While HPV PID is enabled, the IMV must be controlled via constant PWM duty cycle. The reason for this is because two PID controllers acting on IMV and HPV simultaneously would conflict. Typically, RPC is performed using IMV PID control while applying a constant duty cycle to the HPV. The RPC function must also have rail pressure feedback from an analog sensor mounted to the fuel rail. The analog signal can be connected to any of the four channels of the optional NI 9220 analog input module. The utilized analog channel can be selected via this Rail Pressure Control Setup window.

Typical IMV and HPV solenoids require up to 3A continuous current operation. Therefore it is important to utilize the [LS channel linking](#) feature which locks LS1 with LS2 and locks LS3 with LS4. The locked channel pairs can be used to operate the IMV and HPV with up to 3A continuous current. The example wiring diagram, figure 4.10.a, illustrates wiring an IMV to a locked LS1 and LS2 pair, and wiring a HPV to a locked LS3 and LS4 pair. The LS channel locking feature can be implemented via the [PFI and LS Driver 1 Setup](#) window.

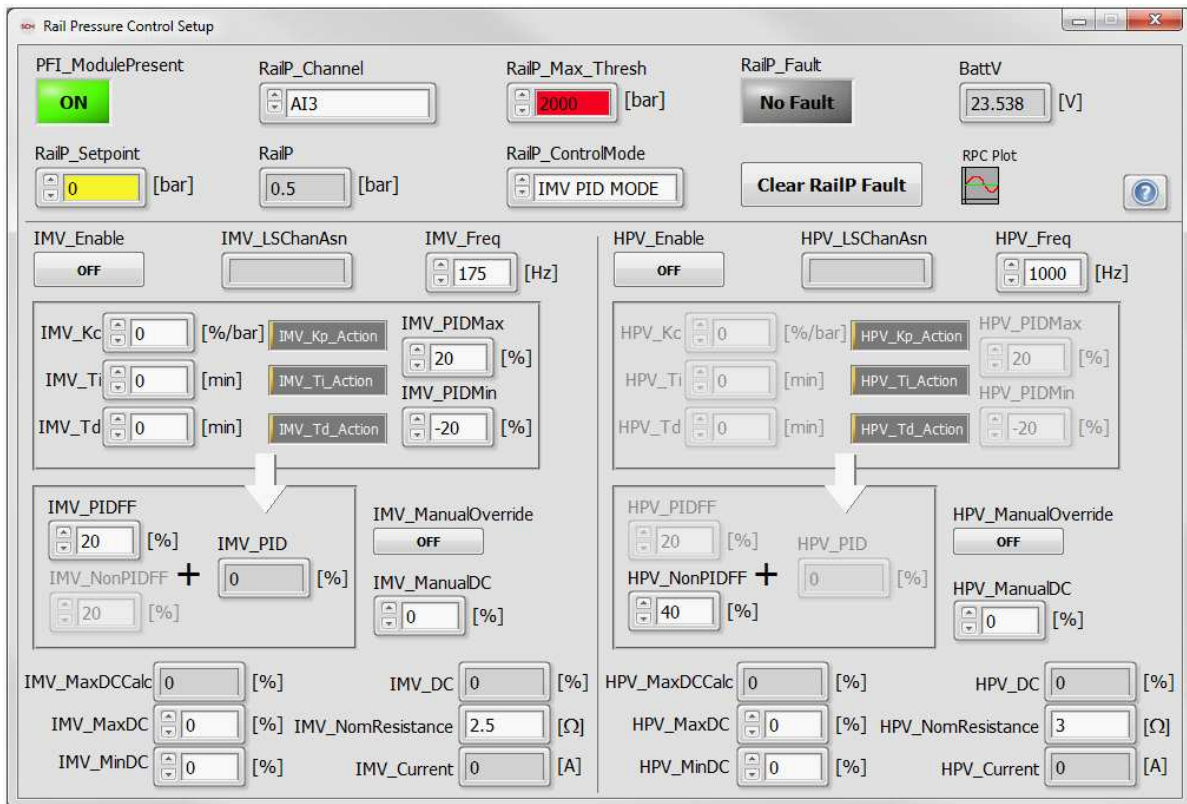

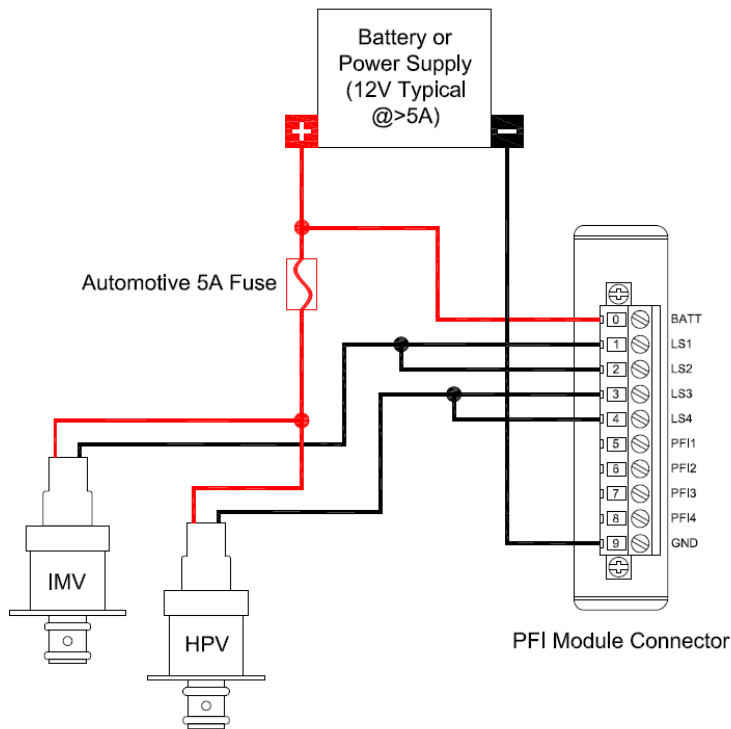

Figure 4.10.a, Diagram of Typical Wiring of an Inlet Metering Valve (IMV) and a High Pressure Valve (HPV) to a PFI Driver Module

1 PFI_ModulePresent



Tip Strip: Indicates PFI Driver module present and externally powered

Detail: Indicates that the system software detects that the PFI Driver module is externally powered and inserted in the assigned slot.

2 RailP_Channel

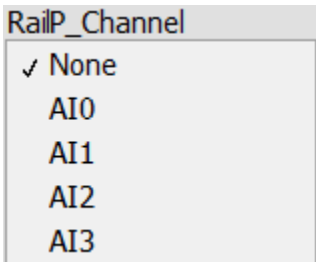

Tip Strip: Assigns analog signal source to IMV and HPV rail pressure controller

Detail: Selects one of the four channels of the [NI 9220 analog input module](#) assigned to rail pressure PID control feedback.

3 RailP_Max_Thresh



Tip Strip: Rail pressure maximum threshold which causes a critical fault and shuts down associated PFI LSX channels

Units: bar

Detail: An upper threshold for rail pressure which defines a critical fault level that could potentially damage the fuel system. If this threshold is exceeded, the low-side channels controlling the IMV and HPV turn off until the [RailPFault](#) error has been cleared.

4 RailP_Fault



Tip Strip: Indicates the rail pressure fault status

Detail: Indicates that the rail pressure has exceeded the value specified in [RailP_Max_Thresh](#). This fault must be manually cleared by [Clear RailP Fault](#).

5 BattV

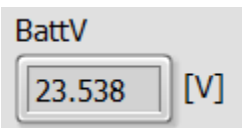

Tip Strip: Battery voltage measured by the DI Driver module

Units: V

Detail: Battery voltage measured by the DI Driver module. Battery voltage is used to calculate, in real time, the current supplied to the IMV and HPV solenoids, to ensure that the current does not exceed 3A.

6 RailP_Setpoint

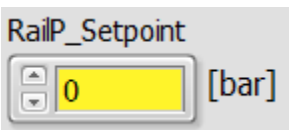

Tip Strip: Rail pressure setpoint to PID controller

Units: bar

Detail: Desired rail pressure setpoint.

7 RailP

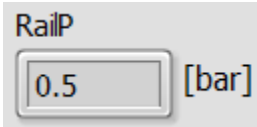

Tip Strip: Rail pressure in bar

Units: bar

Detail: Rail pressure used as feedback to the PID controller. The analog channel utilized for pressure feedback is selected via [RailP_Channel](#). The analog channel must be converted to units of bar via the Analog Input Setup window.

8 RailP_ControlMode

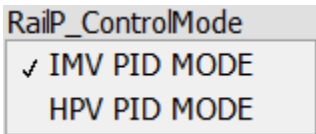

Tip Strip: Selects the IMV or HPV as controlled by PID

Detail: Selects between **IMV PID Mode** or **HPV PID Mode**. When in **IMV PID Mode**, the HPV PID control parameters will be disabled (grayed out) and the HPV will be controlled by a constant duty cycle and frequency. When in **HPV PID Mode**, the IMV PID control parameters will be disabled (grayed out) and the IMV will be controlled by a constant duty cycle and frequency.

9 Clear RailP Fault



Tip Strip: Clears faults related to rail pressure control

Detail: Clears [RailP_Fault](#) after the fault has been resolved.

10 RPC Plot

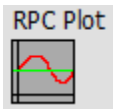

Tip Strip: Opens a plot window of [RailP_Setpoint](#), [RailP](#), [IMV_DC](#) and [HPV_DC](#).



11 IMV_Enable

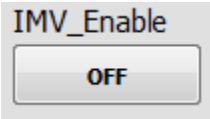

Tip Strip: Enables PWM control of IMV

Detail: Enables the final PWM parameters to the lowside channels configured for IMV via the [PFI and LS Driver 1 Setup](#) window.

12 IMV_LSChanAsn

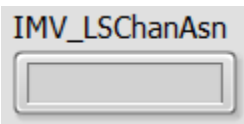

Tip Strip: Indicates the PFI Driver lowside channels assigned to drive the IMV. The channel assignment is configured via the [PFI and LS Driver 1 Setup](#) window.

13 IMV_Freq



Tip Strip: Operating Frequency of IMV PWM command

Units: Hz

Detail: Frequency of the PWM signal to the IMV solenoid.

14 IMV_Kc



Tip Strip: IMV PID proportional gain

Units: %/bar

Detail: Proportional gain. A value of zero disables proportional, integral, and derivative contributions to the PID output. (See the equation in [Auxiliary PID Controller Setup](#) for reference.) Smaller values cause less proportional contribution to the PID output. Larger values cause more proportional contribution to the PID output. Negative values will generate PID outputs that are inversely proportional to the error ([Setpoint](#) – [Process Variable](#)).

15 IMV_Kp_Action

IMV_Kp_Action

Tip Strip: Proportional contribution of IMV PID controller

Detail: Indicates the contribution of the proportional term to the total PID output.

16 IMV_Ti

IMV_Ti [min]

Tip Strip: Integral time constant for IMV PID controller (lower = stronger action. 0 = disabled.)

Units: min

Detail: Integral time constant for the IMV PID controller. A value of zero disables integral contribution to the PID output. Smaller non-zero values cause more contribution to the PID output. Larger values cause less contribution to the PID output. Negative values should not be used.

17 IMV_Ti_Action

IMV_Ti_Action

Tip Strip: Integral contribution of IMV PID controller

Detail: Indicates the contribution of the integral term to the total PID output.

18 IMV_Td

IMV_Td [min]

Tip Strip: Derivative time constant for IMV PID controller (higher = stronger action. 0 = disabled.)

Units: min

Detail: Derivative time constant for the IMV PID controller. A value of zero disables derivative contribution to the PID output. Smaller values cause less contribution to the PID output. Larger values cause more contribution to the PID output. Negative values should not be used.

19 IMV_Td_Action

IMV_Td_Action

Tip Strip: Derivative contribution of IMV PID controller

Detail: Indicates the contribution of the derivative term to the total PID output.

20 IMV_PIDMax

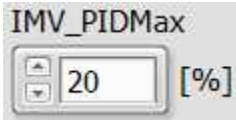

Tip Strip: IMV PID output maximum limit (before feed forward is added) (Max=30,Min=0)

Units: %

Detail: Maximum output allowed from the PID controller, before the feed forward ([IMV_PIDFF](#)) is added.

21 IMV_PIDMin

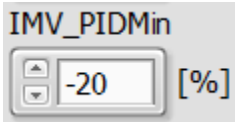

Tip Strip: IMV PID output minimum limit (before feed forward is added)

Units: %

Detail: Minimum output allowed from the PID controller, before the feed forward ([IMV_PIDFF](#)) is added.

22 IMV_PIDFF



Tip Strip: Duty cycle feed forward added to the IMV PID output

Units: %

Detail: Feed forward value that is added to the PID output value. The result is placed in [IMV_DC](#). This parameter is only applicable when [RailP_ControlMode](#) is set to **IMV PID Mode**.

23 IMVNonPIDFF

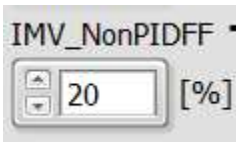

Tip Strip: Duty cycle feed forward for the IMV while doing PID control of the HPV

Units: %

Detail: Feed forward duty cycle applied to the IMV when [RailP_ControlMode](#) is in **HPV PID Mode**.

24 IMV_PID

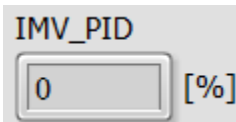

Tip Strip: IMV PID controller output added to [IMV_PIDFF](#). Result is directed to selected PFI LS channel duty cycle parameter.

Units: %

Detail: Output value from the PID controller. This value is limited by the values in [IMV_PIDMin](#) and [IMV_PIDMax](#). This value is added to [IMV_PIDFF](#) and the result is placed in [IMV_DC](#).

25 IMV_ManualOverride

IMV_ManualOverride

Tip Strip: Causes ManualDC to override IMV PID final output

Detail: When **ON**, Cause the PID controller to be bypassed and sets PWM parameters for the IMV with a constant duty cycle defined by [IMV_ManualDC](#).

26 IMV_ManualDC

IMV_ManualDC

 [%]

Tip Strip: Value to override IMV PID final output when ManualOverride=TRUE

Units: %

Detail: Manual duty cycle applied to IMV when [IMV_ManualOverride](#) is on.

27 IMV_MaxDCCalc

IMV_MaxDCCalc [%]

Tip Strip: Maximum allowed duty cycle for IMV based on battery voltage and nominal solenoid resistance to limit current to 3A for channel pair

Units: %

Detail: Maximum duty cycle limit based on the battery voltage and the nominal resistance of the valve. This value prevents the current from exceeding the limitations of the LS channels driving the IMV solenoid.

28 IMV_MaxDC

IMV_MaxDC [%]

Tip Strip: Maximum allowed duty cycle for IMV. This value is effective if lower than [IMV_MaxDCCalc](#).

Units: %

Detail: Maximum allowed duty cycle for IMV. This value is effective if lower than [IMV_MaxDCCalc](#).

29 IMV_MinDC

 [%]

Tip Strip: Minimum allowed duty cycle for IMV.

Units: %

Detail: Minimum allowed duty cycle for IMV.

30 IMV_DC

 [%]

Tip Strip: Final IMV duty cycle

Units: %

Detail: Final duty cycle applied to the IMV solenoid.

31 IMV_NomResistance

 [Ω]

Tip Strip: Nominal resistance of IMV solenoid

Units: Ohms

Detail: Nominal resistance of the IMV solenoid. This value is used to calculate the maximum final duty cycle allowed to the IMV. It is important to measure this resistance within +/-0.5 ohms

32 IMV_Current

 [A]

Tip Strip: Estimated current to IMV based on battery voltage and nominal solenoid resistance

Units: A

Detail: An estimate of the current flowing through the IMV based on the duty cycle, battery voltage, and the nominal resistance of the valve.

33 HPV_Enable

Tip Strip: Enables PWM control of HPV

Detail: Enables the final PWM parameters to the lowside channels configured for HPV via the [PFI and LS Driver 1 Setup](#) window.

34 HPV_LSChanAsn

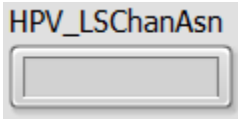

Tip Strip: Indicates the PFI Driver lowside channels assigned to drive the HPV. The channel assignment is configured via the [PFI and LS Driver 1 Setup](#) window.

35 HPV_Freq

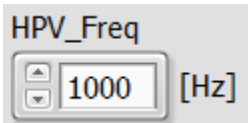

Tip Strip: Operating Frequency of HPV PWM command
Units: Hz
Detail: Frequency of the PWM signal to the HPV solenoid.

36 HPV_Kc



Tip Strip: HPV PID proportional gain
Units: %bar
Detail: Proportional gain. A value of zero disables proportional, integral, and derivative contributions to the PID output. (See the equation in [Auxiliary PID Controller Setup](#) for reference.) Smaller values cause less proportional contribution to the PID output. Larger values cause more proportional contribution to the PID output. Negative values will generate PID outputs that are inversely proportional to the error ([Setpoint](#) – [Process Variable](#)).

37 HPV_Kp_Action



Tip Strip: Proportional contribution of HPV PID controller
Detail: Indicates the contribution of the proportional term to the total PID output.

38 HPV_Ti

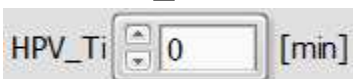

Tip Strip: Integral time constant for HPV PID controller (lower = stronger action. 0 = disabled.)

Units: min

Detail: Integral time constant. A value of zero disables integral contribution to the PID output. Smaller non-zero values cause more contribution to the PID output. Larger values cause less contribution to the PID output. Negative values should not be used.

39 HPV_Ti_Action

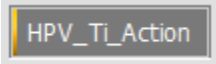

Tip Strip: Integral contribution of HPV PID controller

Detail: Indicates the contribution of the integral term to the total PID output.

40 HPV_Td

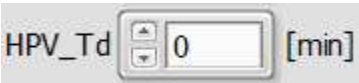

Tip Strip: Derivative time constant for HPV PID controller (higher = stronger action. 0 = disabled.)

Units: min

Detail: Derivative time constant. A value of zero disables derivative contribution to the PID output. Smaller values cause less contribution to the PID output. Larger values cause more contribution to the PID output. Negative values should not be used.

41 HPV_Td_Action

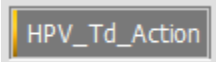

Tip Strip: Derivative contribution of HPV PID controller

Detail: Indicates the contribution of the derivative term to the total PID output.

42 HPV_PIDMax

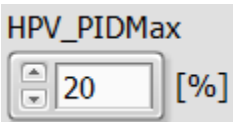

Tip Strip: HPV PID output maximum limit (before feed forward is added)

Units: %

Detail: Maximum output allowed from the PID controller, before the feed forward ([HPV_PIDFF](#)) is added.

43 HPV_PIDMin

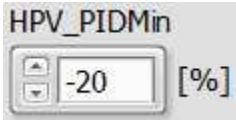

Tip Strip: HPV PID output minimum limit (before feed forward is added)

Units: %

Detail: Minimum output allowed from the PID controller, before the feed forward ([HPV_PIDFF](#)) is added.

44 HPV_PIDFF

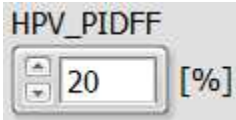

Tip Strip: Duty cycle feed forward added to the HPV PID output

Units: %

Detail: Feed forward value that is added to the PID output value. The result is placed in [HPV_DC](#). This parameter is only applicable when [RailP_ControlMode](#) is set to **HPV PID Mode**.

45 HPV_NonPIDFF

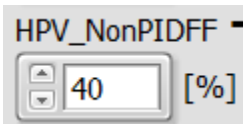

Tip Strip: Duty cycle feed forward for the HPV while doing PID control of the IMV

Units: %

Detail: Feed forward duty cycle applied to the HPV when [RailP_ControlMode](#) is in **IMV PID MODE**.

46 HPV_PID

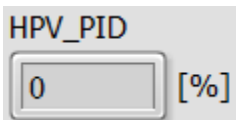

Tip Strip: HPV PID controller output added to HPV_PIDFF. Result is directed to selected PFI LS channel duty cycle parameter.

Units: %

Detail: Output value from the PID controller. This value is limited by the values in [HPV_PIDMin](#) and [HPV_PIDMax](#). This value is added to [HPV_PIDFF](#) and the result is placed in [HPV_DC](#).

47 HPV_ManualOverride

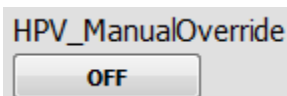

Tip Strip: Causes ManualDC to override HPV PID final output

Detail: When **ON**, causes the PID controller to be bypassed and sets PWM parameters for the HPV with a constant duty cycle defined by [HPV_ManualDC](#).

48 HPV_ManualDC

HPV_ManualDC

 [%]

Tip Strip: Value to override HPV PID final output when ManualOverride=TRUE

Units: %

Detail: Manual duty cycle applied to HPV when [HPV_ManualOverride](#) is enabled.

49 HPV_MaxDCCalc

HPV_MaxDCCalc

 [%]

Tip Strip: Maximum allowed duty cycle for HPV based on battery voltage and nominal solenoid resistance to limit current to 3A for channel pair

Units: %

Detail: Maximum duty cycle limit based on the battery voltage and the nominal resistance of the valve. This value prevents the current from exceeding the limitations of the LS channels driving the HPV solenoid.

50 HPV_MaxDC

HPV_MaxDC

 [%]

Tip Strip: Maximum allowed duty cycle for HPV. This value is effective if lower than [HPV_MaxDCCalc](#).

Units: %

Detail: Maximum allowed duty cycle for HPV. This value is effective if lower than [HPV_MaxDCCalc](#).

51 HPV_MinDC

HPV_MinDC

 [%]

Tip Strip: Minimum allowed duty cycle for HPV

Units: %

Detail: Minimum allowed duty cycle for HPV

52 HPV_DC

HPV_DC [%]

Tip Strip: Final HPV duty cycle

Units: %

Detail: Final duty cycle applied to the HPV solenoid.

53 HPV_NomResistance

HPV_NomResistance [Ω]

Tip Strip: Nominal resistance of HPV solenoid

Units: Ohms

Detail: Nominal resistance of the HPV solenoid. This value is used to calculate the maximum duty cycle applied to the HPV. It is important to measure this resistance within +/-0.5 ohms

4.19 Auxiliary PWM Setup Window

The purpose of the Auxiliary PWM Setup window is to configure up to four independent internally generated Pulse Width Modulation (PWM) signals to be assigned to digital input destinations via the [Digital Input Setup](#) window. The timing specification can be Frequency or Period, and the control specification can be Duty Cycle or Pulse Width.

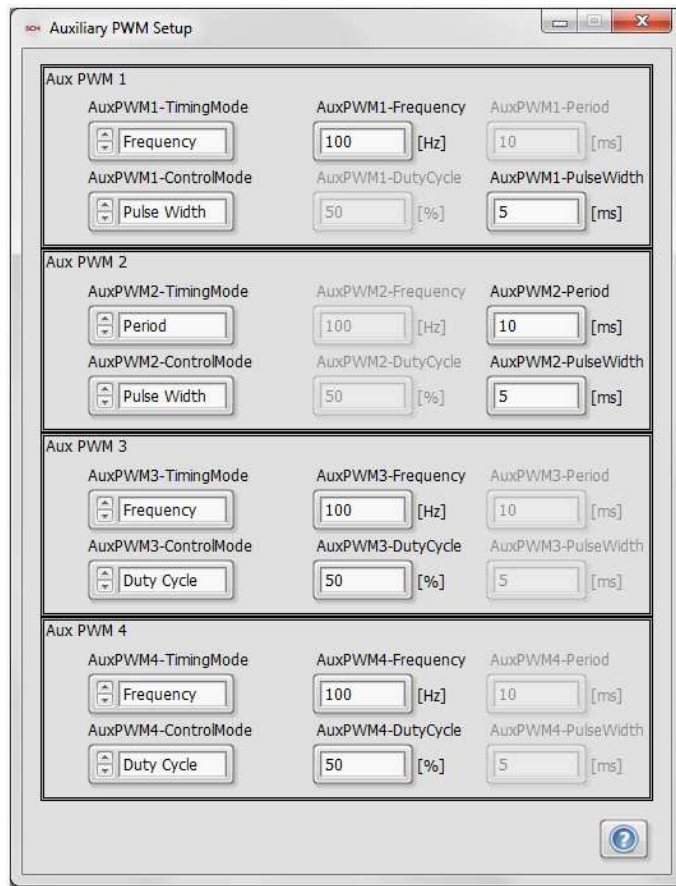

1 AuxPWMX-TimingMode

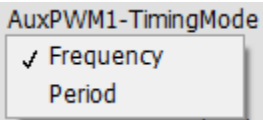

Tip Strip: Format of PWM signal command

Detail: Selects the specification mode for the time between rising edges of the PWM signal. The options are **Frequency** or **Period**. The fields for **Frequency** or **Period** will be enabled according to the selection.

2 AuxPWMX-ControlMode

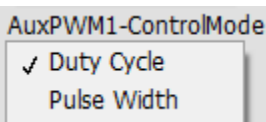

Tip Strip: Format of PWM signal command

Detail: Selects the specification mode for the time between rising and falling edges of the PWM signal. The options are **Duty Cycle** or **Pulse Width**. The fields for **Duty Cycle** or **Pulse Width** will be enabled according to the selection.

3 AuxPWMX-Frequency

AuxPWM1-Frequency

 [Hz]

Tip Strip: Frequency of PWM signal

Units: Hz

Detail: When [AuxPWMX-TimingMode](#) is set to **Frequency**, this field is enabled for specifying the time between rising edges of the PWM signal.

4 AuxPWMX-DutyCycle

AuxPWM1-DutyCycle

 [%]

Tip Strip: Duty cycle of PWM signal

Units: %

Detail: When [AuxPWMX-ControlMode](#) is set to **Duty Cycle**, this field is enabled for specifying the time between rising and falling edges of the PWM signal.

5 AuxPWMX-Period

AuxPWM1-Period

 [ms]

Tip Strip: Period of PWM signal

Units: msec

Detail: When [AuxPWMX-TimingMode](#) is set to **Period**, this field is enabled for specifying the time between rising edges of the PWM signal.

6 AuxPWMX-PulseWidth

AuxPWM1-PulseWidth

 [ms]

Tip Strip: Pulse width of PWM signal

Units: msec

Detail: When [AuxPWMX-ControlMode](#) is set to **Pulse Width**, this field is enabled for specifying the time between rising and falling edges of the PWM signal.

7 Aux PWX 2-4

Aux PWM 2		
AuxPWM2-TimingMode <input type="text" value="Period"/>	AuxPWM2-Frequency <input type="text" value="100"/> [Hz]	AuxPWM2-Period <input type="text" value="10"/> [ms]
AuxPWM2-ControlMode <input type="text" value="Pulse Width"/>	AuxPWM2-DutyCycle <input type="text" value="50"/> [%]	AuxPWM2-PulseWidth <input type="text" value="5"/> [ms]

Aux PWM 3		
AuxPWM3-TimingMode <input type="text" value="Frequency"/>	AuxPWM3-Frequency <input type="text" value="100"/> [Hz]	AuxPWM3-Period <input type="text" value="10"/> [ms]
AuxPWM3-ControlMode <input type="text" value="Duty Cycle"/>	AuxPWM3-DutyCycle <input type="text" value="50"/> [%]	AuxPWM3-PulseWidth <input type="text" value="5"/> [ms]

Aux PWM 4		
AuxPWM4-TimingMode <input type="text" value="Frequency"/>	AuxPWM4-Frequency <input type="text" value="100"/> [Hz]	AuxPWM4-Period <input type="text" value="10"/> [ms]
AuxPWM4-ControlMode <input type="text" value="Duty Cycle"/>	AuxPWM4-DutyCycle <input type="text" value="50"/> [%]	AuxPWM4-PulseWidth <input type="text" value="5"/> [ms]

See above descriptions.

4.20 Expansion Auxiliary PWM Setup Window

The purpose of the Expansion Auxiliary PWM Setup window is to configure up to four independent internally generated Pulse Width Modulation (PWM) signals to be assigned to digital input destinations via the [Expansion Digital Input Setup](#) window. The timing specification can be Frequency or Period, and the control specification can be Duty Cycle or Pulse Width.

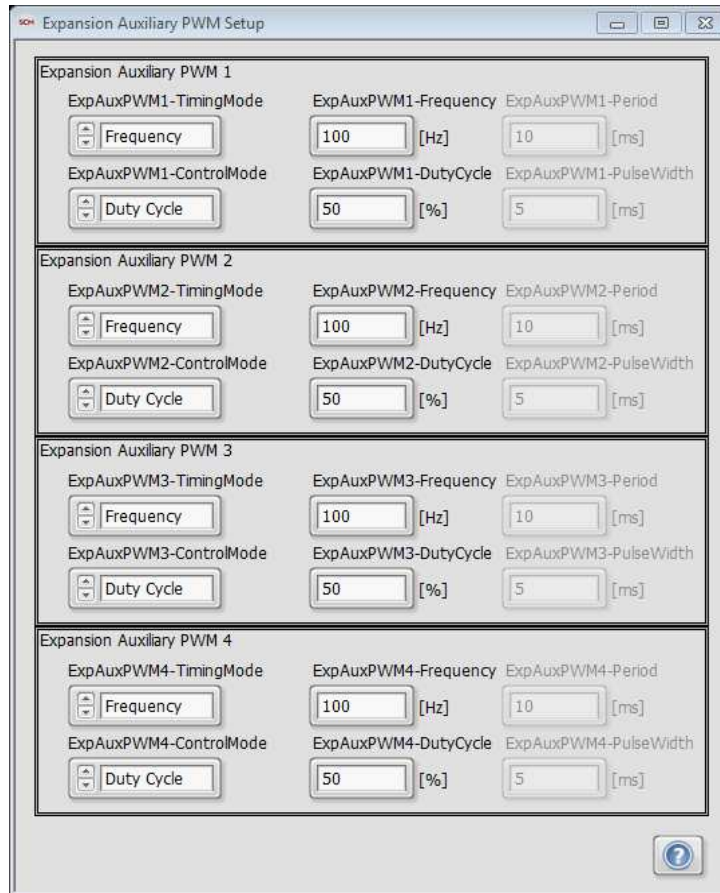

1 ExpAuxPWMX-TimingMode

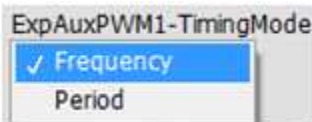

Tip Strip: Format of PWM signal command

Detail: Selects the specification mode for the time between rising edges of the PWM signal. The options are **Frequency** or **Period**. The fields for **Frequency** or **Period** will be enabled according to the selection.

2 ExpAuxPWMX-ControlMode

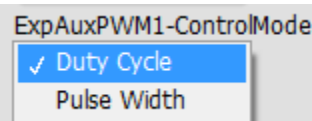

Tip Strip: Format of PWM signal command

Detail: Selects the specification mode for the time between rising and falling edges of the PWM signal. The options are **Duty Cycle** or **Pulse Width**. The fields for **Duty Cycle** or **Pulse Width** will be enabled according to the selection.

3 ExpAuxPWMX-Frequency

ExpAuxPWM1-Frequency

 [Hz]

Tip Strip: Frequency of PWM signal

Units: Hz

Detail: When [ExpAuxPWMX-TimingMode](#) is set to **Frequency**, this field is enabled for specifying the time between rising edges of the PWM signal.

4 ExpAuxPWMX-DutyCycle

ExpAuxPWM1-DutyCycle

 [%]

Tip Strip: Duty cycle of PWM signal

Units: %

Detail: When [ExpAuxPWMX-ControlMode](#) is set to **Duty Cycle**, this field is enabled for specifying the time between rising and falling edges of the PWM signal.

5 ExpAuxPWMX-Period

ExpAuxPWM1-Period

 [ms]

Tip Strip: Period of PWM signal

Units: msec

Detail: When [ExpAuxPWMX-TimingMode](#) is set to **Period**, this field is enabled for specifying the time between rising edges of the PWM signal.

6 ExpAuxPWMX-PulseWidth

ExpAuxPWM1-PulseWidth

 [ms]

Tip Strip: Pulse width of PWM signal

Units: msec

Detail: When [ExpAuxPWMX-ControlMode](#) is set to **Pulse Width**, this field is enabled for specifying the time between rising and falling edges of the PWM signal.

7

Expansion Aux PWMX 2-4

Expansion Auxiliary PWM 2		
ExpAuxPWM2-TimingMode Frequency	ExpAuxPWM2-Frequency 100 [Hz]	ExpAuxPWM2-Period 10 [ms]
ExpAuxPWM2-ControlMode Duty Cycle	ExpAuxPWM2-DutyCycle 50 [%]	ExpAuxPWM2-PulseWidth 5 [ms]

Expansion Auxiliary PWM 3		
ExpAuxPWM3-TimingMode Frequency	ExpAuxPWM3-Frequency 100 [Hz]	ExpAuxPWM3-Period 10 [ms]
ExpAuxPWM3-ControlMode Duty Cycle	ExpAuxPWM3-DutyCycle 50 [%]	ExpAuxPWM3-PulseWidth 5 [ms]

Expansion Auxiliary PWM 4		
ExpAuxPWM4-TimingMode Frequency	ExpAuxPWM4-Frequency 100 [Hz]	ExpAuxPWM4-Period 10 [ms]
ExpAuxPWM4-ControlMode Duty Cycle	ExpAuxPWM4-DutyCycle 50 [%]	ExpAuxPWM4-PulseWidth 5 [ms]

See above descriptions.

4.21 Operating Point Setup Window

The purpose of the Operating Point Table Setup window is to configure two types of operation for automated test cycles:

Timer Mode: Configure time-based, sequential operating points to be executed according to a specified time for each operating point.

Trigger Mode: Configure triggered operating points to be executed according to one or more process variable ranges. As long as the specified range is true for the selected process variable, the associated operating point will be executed.

Up to 254 Flex Control Parameters and up to 254 Operating Points can be implemented. The operating point table function is manually started, paused, and reset. The operating point table can be imported and exported from/to a tab-delimited text file, which can be manipulated using spreadsheets. In Timer Mode, the operating points can be repeated for a specified number of Loops. While Operating Points are enabled, the values for the selected Flex Control Parameters will be overwritten by the associated values in the table.

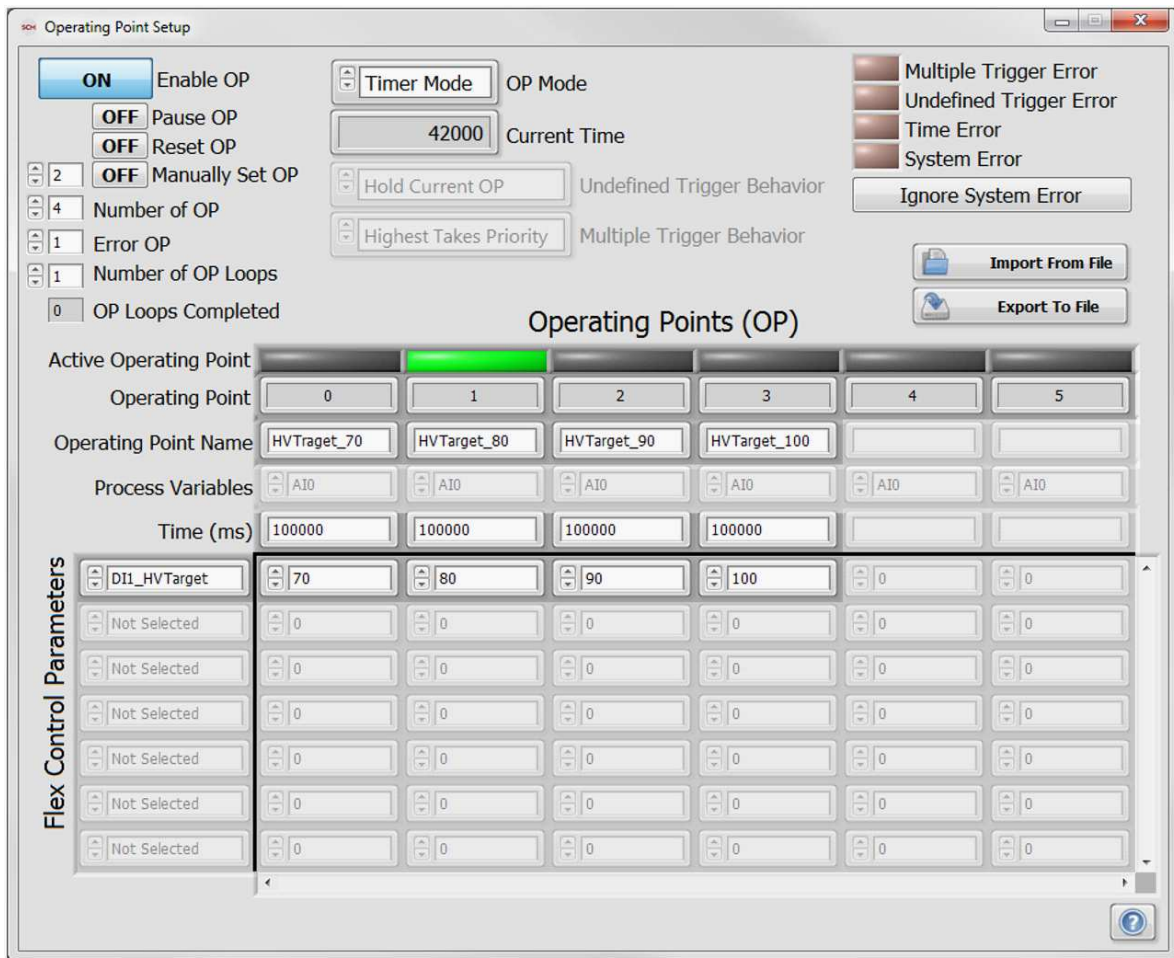

1

Enable OP

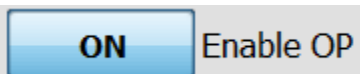

Tip Strip: Enable operating point function

Detail: When **ON**, operating points are active according to the operating point table, and the table values will override the parameter values specified elsewhere within the DI Driver System setup windows. When **OFF**, the parameter values will remain set to the most recent values used from the operating point table. For example, HVTarget for DI Driver Module 1 may be set to 50V via the [DI1 Setup window](#). The Operating Point Setup window may implement a time-based table for incrementing HVTarget by 10V every 10 seconds, from 50V to 100V. At the end of the operating point cycle, HVTarget will be left at the last operating point of 100V. If it is desired that HVTarget be set back to 50V, then an additional operating point should be added to the end of the table to revert back to 50V.

2 Pause OP

OFF Pause OP

Tip Strip: In [Timer Mode](#) pause operating point execution

Detail: When **ON**, pauses the table to remain at the current operating point. When **OFF**, operating point operation resumes. This parameter is only applicable when [Enable OP](#) is **ON**.

3 Reset OP

OFF Reset OP

Tip Strip: In [Timer Mode](#) reset operating point execution to point 0

Detail: In [Timer Mode](#), when **ON**, resets the operating point back to zero. This parameter is not applicable to [Trigger Mode](#). This parameter is only applicable when [Enable OP](#) is **ON**.

4 Manually Set OP

OFF Manually Set OP

Tip Strip: Causes execution of Manual OP

Detail: When **ON**, sets the operating point to the point specified by the value to the left of the button. In [Timer Mode](#), when set to **OFF** execution will resume at the current operating point. In [Trigger Mode](#), when set to **OFF** execution will resume at the operating point determined by the [Process Variable Trigger Wildcards](#).

5 Number of OP

Number of OP

Tip Strip: Number of operating points to be considered for execution

Detail: Specifies the number of operating points to be considered by the operating point function. For example, if [Number of OP](#) is set to 3, then operating points 0, 1, & 2 will be applicable to the function. Operating points 3 and greater will not be considered.

6 Error OP

Error OP

Tip Strip: Operating point executed during error state

Detail: Specifies the operating point which will be executed upon an error condition. This parameter is only applicable if [Undefined Trigger Behavior](#) is set to **Goto Error State** or [Multiple Trigger Behavior](#) is set to **Goto Error State**, and [Ignore System Error](#) is **FALSE**.

7 Number of OP Loops

Number of OP Loops

Tip Strip: Number of operating point loops to execute. 0 = continuous.

Detail: Specifies the number of times to execute the complete set of operating points. A special value of zero means that the cycle will repeat continuously. This parameter is only applicable to [Timer Mode](#).

8 OP Loops Completed

OP Loops Completed

Tip Strip: Indicates the number of operating point loops completed. This parameter is only applicable to [Timer Mode](#).

9 OP Mode

Timer Mode
 Trigger Mode

Tip Strip: Mode of executing operating points

Detail:

Timer Mode: Executes the number of points specified by [Number of OP](#) sequentially, according to the [Time](#) value associated with each operating point.

Trigger Mode: Executes the operating point specified by the selected [Process Variables](#) and their associated [Wildcards](#).

10 Current Time/Trigger

Current Time

Units: msec

Detail: Indicates the current timer value. This parameter is only applicable in [Timer Mode](#).

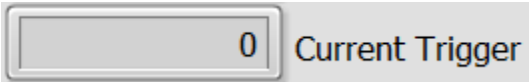

Detail: Indicates the active trigger wildcard. This parameter is only applicable in [Trigger Mode](#).

11 Undefined Trigger Behavior

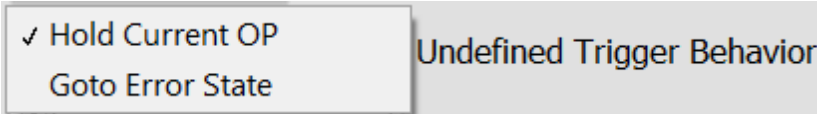

Tip Strip: Determines behavior when no trigger is present

Detail: Selects the behavior of the operating points function while an operating point is not defined during [Trigger Mode](#). This parameter is not applicable to [Timer Mode](#).

Hold Current OP: Do not do anything, but remain in the current operating point until one of the [Trigger Wildcards](#) is satisfied.

Goto Error State: Change operating point to the point specified by [Error OP](#).

12 Multiple Trigger Behavior

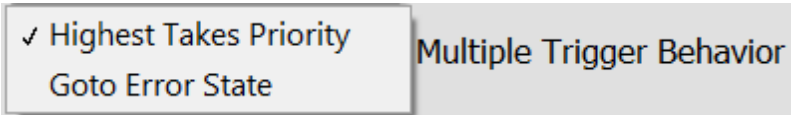

Tip Strip: Determines behavior when multiple triggers are present

Detail: Selects the behavior of the operating points function while there are multiple operating points satisfied by the [Trigger Wildcards](#). This parameter is not applicable to [Timer Mode](#).

Highest Takes Priority: Change operating point to the point which has the highest operating point number (index).

Goto Error State: Change operating point to the point specified by [Error OP](#).

13 Multiple Trigger Error

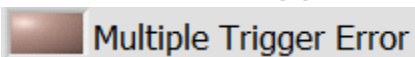

Tip Strip: Indicates multiple triggers are present

Detail: When in [Trigger Mode](#), and [Multiple Trigger Behavior](#) is set to **Goto Error State**, indicates when multiple simultaneous triggers have been encountered and the error state will be executed.

14 Undefined Trigger Error



Tip Strip: Indicates no trigger is defined for selected CalPoints

Detail: When in [Trigger Mode](#), indicates when no trigger condition is satisfied by the specified [Trigger Wildcards](#), and the error state will be executed.

15 Time/Wildcard Error

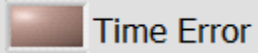

Tip Strip: Invalid entry for an operating point time value

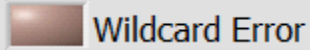

Tip Strip: Invalid entry for a wildcard

Detail: When in [Timer Mode](#), indicates when one or more of the [Time](#) fields have non-numeric characters entered, and the error state will be executed. When in [Trigger Mode](#), indicates when one or more of the [Wildcard](#) fields have an invalid entry, and the error state will be executed.

16 System Error

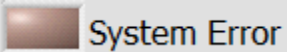

Tip Strip: Indicates DI Driver System error has occurred

Detail: Indicates when a critical error is present related to the DI Driver modules, PFI Driver module, or EPT, and the error state will be executed if the [Ignore System Error](#) button is **FALSE**.

17 Ignore System Error

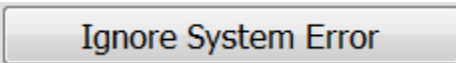

Tip Strip: When enabled OP will continue regardless of DI Driver System errors

Detail: When set to **True**, normal execution of the operating point function will take place, regardless of the state of the [System Error](#). When **FALSE**, and a System Error is present, the error state will be executed.

18 Import From/Export To File

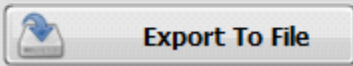
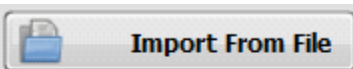

Tip Strip: Import/export tab-delimited text files

Detail: The operating point table can be imported and exported from/to a tab-delimited text file, which can be manipulated using text editors or spreadsheets. National Instruments recommends using a text editor, such as Notepad or WordPad, when editing the operating point table outside the provided interface. If MS Excel is used to edit the operating point table, care must be taken to ensure that any quotation marks around the data added by MS Excel are removed from the text-based version of the file before importing back into the DI Driver System application.

19 Active Operating Point



Detail: Array of Boolean LED indicators, highlighting the active operating point.

20 Operating Point

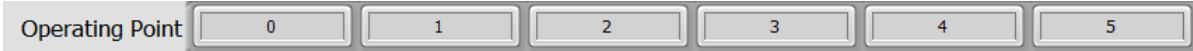

Detail: Displays the number of the operating point, starting from 0. The operating point numbers cannot be changed

21 Operating Point Name

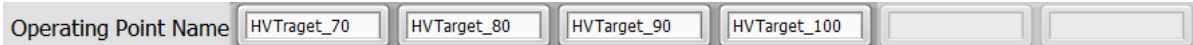

Detail: String fields allowing the operator to enter text names for each operating point.

22 Process Variables

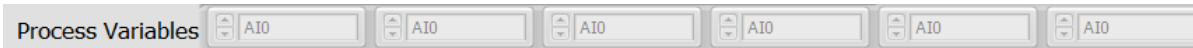

Detail: Array of drop-down selection controls for selecting the [Trigger Mode](#) process variable for each operating point. The available parameters for selection are analog inputs, battery voltage, digital input parameters, cam phase, engine speed, and user variables. Typically, all operating points would utilize the same process variable. For example, a set of four operating points could be created for four different ranges of digital input frequency. However, complex operating point tables may be created using multiple inputs.

23 Time/Trigger Wildcards

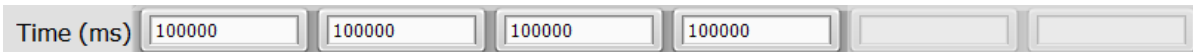

Units: msec

Detail: Array of time values for each operating point while in [Timer Mode](#). After the time for each operating point elapses, execution will proceed to the next sequential operating point.

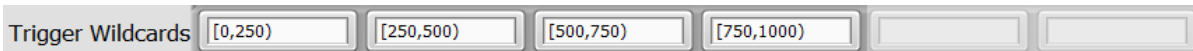

Detail: Array of text-based specifications for each operating point while in [Trigger Mode](#).

When a [Trigger Wildcard](#) specification is TRUE, the associated operating point will be executed. The behavior of the operating point function while no [Trigger Wildcard](#) is satisfied or multiple [Trigger Wildcards](#) are satisfied is determined by the settings of the [Undefined Trigger Behavior](#) and [Multiple Trigger Behavior](#) parameters. The syntax for [Trigger Wildcard](#) entries is as follows:

Parenthesis Bounded (Lower Value, Upper Value)

Detail: [Trigger Wildcard](#) is satisfied if the [Process Variable](#) is greater than Lower Value and less than Upper Value

Example: (20,40) [Trigger Wildcard](#) is satisfied if the [Process Variable](#) is greater than 20 and less than 40.

Bracket Bounded [Lower Value, Upper Value]

Detail: [Trigger Wildcard](#) is satisfied if the [Process Variable](#) is greater than or equal to Lower Value and less than or equal to Upper Value

Example: [20,40] [Trigger Wildcard](#) is satisfied if the [Process Variable](#) is greater than or equal to 20 and less than or equal to 40.

Note: A [Trigger Wildcard](#) can combine the usage of parenthesis and brackets.

Example: [20, 40) [Trigger Wildcard](#) is satisfied if the [Process Variable](#) is greater than or equal to 20 and less than 40.

Single Point Value

Detail: [Trigger Wildcard](#) is satisfied if the [Process Variable](#) is exactly equal to the single point value. It is not recommended to use this type of [Trigger Wildcard](#) for continuously variable [Process Variables](#). This type of Wildcard should be used for Boolean [Process Variables](#).

Example: A [Trigger Wildcard](#) single point value of **1** is satisfied if a Boolean parameter, such as 9411_1.0 State is equal to **1**, or **TRUE**.

Note: For single point value Wildcards, do not use text such as TRUE or FALSE. Use **1** to represent **TRUE** and **0** to represent **FALSE**.

Blank

Detail: If [Trigger Wildcard](#) is blank, then the associated operating point is always satisfied. This type of Wildcard can be useful to specify a default operating point if it is used for operating point 0. If no other Wildcard is satisfied, then the default operating point will be executed, without setting the [Undefined Trigger Error](#). If another higher operating point Wildcard is satisfied, then the higher operating point will be executed if the [Multiple Trigger Behavior](#) control is set to “Highest Takes Priority”. Otherwise, the [Error OP](#) operating point will be executed.

24 Flex Control Parameters



Detail: Array of drop-down selection controls for selecting the [Flex Control Parameter](#) to be manipulated by each operating point. There are many [Flex Control Parameters](#) to choose from, related to many different controls from various setup windows within the DI Driver System. The value for each selected [Flex Control Parameter](#) will be overwritten by the value entered for each active operating point in the table. The Flex Control Parameter can be selected one of two ways: by left unclicking and searching through the full list of Flex Control Parameters, shown above, or by right unclicking and searching through a hierarchical list of menus to find the particular Flex Control Parameter of interest, as shown in the [Direct Mapping Section](#).

25 Operating Point Table Values

70	80	90	100	0	0
0	0	0	0	0	0
0	0	0	0	0	0
0	0	0	0	0	0
0	0	0	0	0	0
0	0	0	0	0	0
0	0	0	0	0	0
0	0	0	0	0	0

Detail: The table values are shown as a two dimensional array of values, specifying the value to overwrite each selected [Flex Control Parameter](#) during each active operating point. Most [Flex Control Parameters](#) are single-point precision controls which require a single-point precision numeric value. Some [Flex Control Parameters](#) are Boolean controls which require a value of **0** or **1** to represent **FALSE** or **TRUE**, respectively. Other [Flex Control Parameters](#) are mode controls from various system setup windows which have drop-down text descriptions. The text descriptions should not be entered in these table fields. Instead, the integer representation should be entered, starting with 0 for the first drop-down selection.

4.22 User Variables

Sixteen Flex Control Parameters are available as general purpose variable storage. They are named UserVariable1 through UserVariable16. The User Variables Window is used to document and manually specify the value of each user variable. If a lookup table output value is mapped to one of these user variables, then the lookup table output value will overwrite the user variable in this tab. User variables can also be selected as inputs to the lookup tables. It is important that the user variables not be selected as both input and output parameters.

The screenshot shows the 'User Variables Setup' window. It contains a table with the following columns: Index, User Variable Value, User Variable Name, Units, and User Variable Description. The table is populated with 16 rows. The first two rows are pre-filled with data, while the remaining 14 rows are empty.

Index	User Variable Value	User Variable Name	Units	User Variable Description
1	1.125	Lambda SP		Variable storage for Lambda set point for 1D table lookup
2	230	VVT		Variable storage setpoint from 1D lookup table
3	0			
4	0			
5	0			
6	0			
7	0			
8	0			
9	0			
10	0			
11	0			
12	0			
13	0			
14	0			
15	0			
16	0			

User Variables Setup

Index	User Variable Value	User Variable Name	Units	User Variable Description
1	1.125	Lambda SP		Variable storage for Lambda set point for 1D table lookup
2	168.75	VVT		Variable storage setpoint from 1D lookup table
3	0			
4	0			
5	0			
6	0			
7	0			
8	0			
9	0			
10	0			
11	0			
12	0			
13	0			
14	0			
15	0			
16	0			

Table Setup

Table2D_1	Table2D_2	Table2D_3	Table2D_4	Table2D_5	Table2D_6	Table2D_7
Table1D_1	Table1D_2	Table1D_3	Table1D_4	Table1D_5	Table1D_6	Table1D_7

Enable Table1D_2

Table1D_2_InputSelector:

Table1D_2_Description: Controls VVT setpoint as a function of lambda setpoint

X	Y
0.8500	120.0
0.9000	0.000
0.9500	37.50
1.000	75.00
1.050	112.5
1.100	150.0
1.150	187.5
1.200	225.0
1.250	262.5
1.300	300.0

Table1D_2_FlexControlParameters

<input type="text" value="UserVariable2"/>
<input type="text" value="Not Selected"/>
<input type="text" value="Not Selected"/>
<input type="text" value="Not Selected"/>
<input type="text" value="Not Selected"/>
<input type="text" value="Not Selected"/>
<input type="text" value="Not Selected"/>
<input type="text" value="Not Selected"/>
<input type="text" value="Not Selected"/>
<input type="text" value="Not Selected"/>
<input type="text" value="Not Selected"/>
<input type="text" value="Not Selected"/>

4.23 XNET CAN Setup Window

The purpose of the XNET CAN Setup window is to configure the operation of the [NI 9862 XNET CAN module](#) to communicate data to and from external devices that are on the same network. To use the DI Driver System XNET CAN feature, you must download NI-XNET driver version 15.0 or later. It is freely downloadable from <http://sine.ni.com/psp/app/doc/p/id/psp-903/lang/en>.

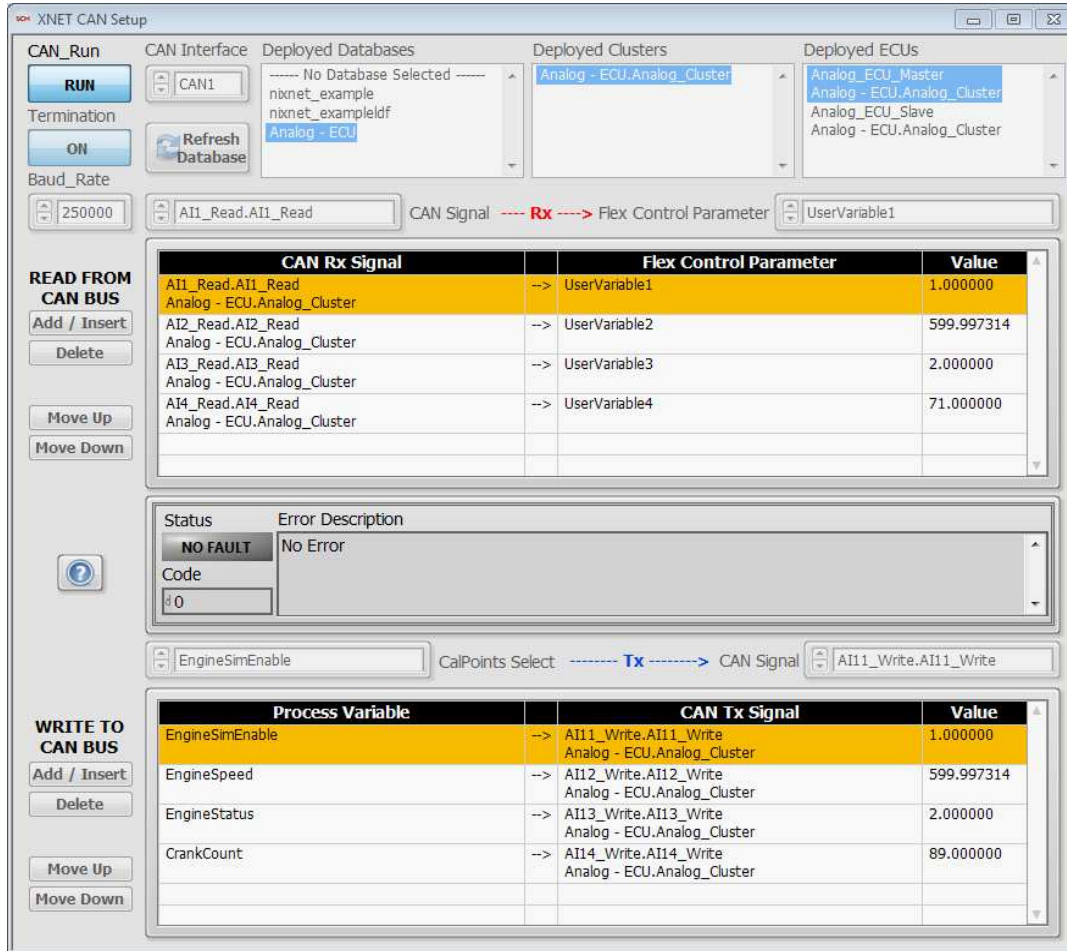

1 CAN_Run

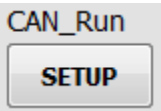

Tip Strip: Commences communication to external CAN device(s)

Detail: If the NI 9862 XNET CAN module is externally powered in its [assigned slot](#) and the variables are appropriately mapped to the CAN signal list, CAN communication between the DI Driver system and external CAN device(s) will begin as soon as the [CAN Init](#) button is pressed.

2 Termination

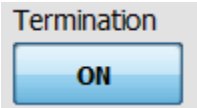

Tip Strip: Enables 120 Ohm termination at the module

Detail: The Termination property configures the onboard 120 Ohm termination of the NI-XNET interface CAN connector (port). If your bus already has the correct amount of termination, leave this property in the default state of Off. However, if you require termination, set this property to On.

3 CAN Interface

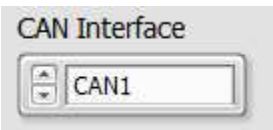

Tip Strip: CAN Interface Module when module is externally powered and recognized by the software

Detail: The interface represents a single CAN on an NI hardware device. Within NI-XNET, the interface is the object used to communicate with external hardware described in the database. If the module is in the [assigned slot](#) and is externally powered, the module should appear under a generic "CANX". If the field is blank, check the module slot assignment and power wiring to the module.

4 Baud_Rate

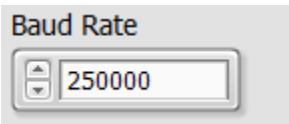

Tip Strip: CAN communication data transfer rate

Units: bit/s

Detail: NI-XNET CAN hardware currently accepts the following numeric baud rates: 33333, 40000, 50000, 62500, 80000, 83333, 100000, 125000, 160000, 200000, 250000, 400000, 500000, 800000, and 1000000.

5 Refresh Database

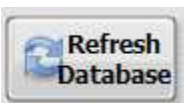

Tip Strip: Refreshes a list of deployed databases on this controller

Detail: Press this button to refresh database list after deploying or undeploying a database

6 Deployed Databases

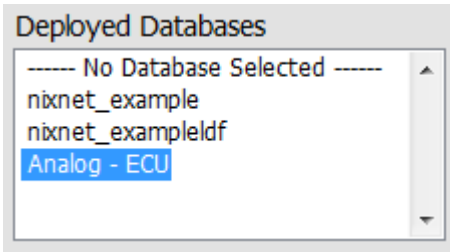

Tip Strip: A list of deployed databases on the controller

Detail: Use NI-XNET database editor ([see section 4.23.1](#)) to create, edit, deploy and undeploy databases from the controller. The Deployed Databases list will be updated once the [Refresh Database](#) button is pressed.

7 Deployed Clusters

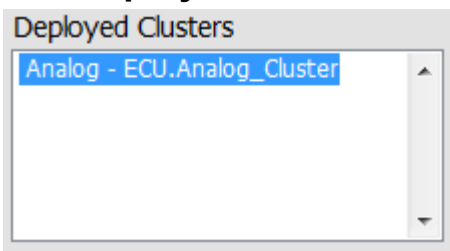

Tip Strip: A list of clusters from selected database on the controller

Detail: The basic entity of a database is a cluster. A cluster is the description of a single network (for example, a CAN bus). For CAN, the cluster contains only the baud rate.

Usually, a database contains only one cluster. For example, the NI-CAN database and vector CANdb formats support only one cluster. However, FIBEX supports multiple clusters per database; you could, for example, describe all of a car's networks in a single database.

8 Deployed ECUs

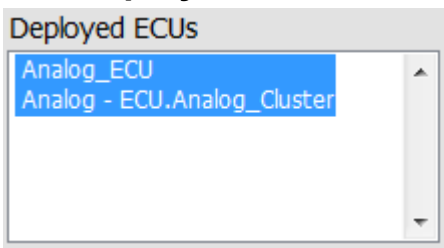

Tip Strip: A list of ECUs from selected ECU database on the controller

Detail: ECUs appear in the NI-XNET Database Editor only as transmitters and receivers of frames within clusters. They are not separate entities. This means that the same ECU might appear in different clusters of the database, but in the exported FIBEX file, it appears as different ECU entities.

Read from CAN Bus

9 Add/Insert



Tip Strip: Add/Insert item onto the “Read from CAN Bus” List box

Detail: Clicking Add/Insert button to start mapping a variable from CAN signal list to a variable on the Flex Control Parameter list. When there are duplicate line items, they will be highlighted red and the [CAN Init](#) button will be grayed out and disabled.

10 Delete



Tip Strip: Delete selected item from the “Read from CAN Bus” List box

11 Move Up

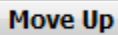

Tip Strip: Move selected item up the “Read from CAN Bus” List box

12 Move Down

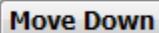

Tip Strip: Move selected item down the “Read from CAN Bus” List box

13 CAN Signal

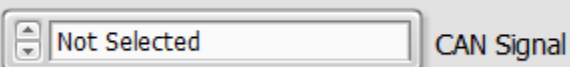

Tip Strip: CAN signal list when according to a selected database on the Deployed Databases list

Detail: This list will be populated according to signals defined in the selected database on the controller

14 Flex Control Parameter

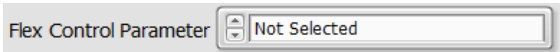
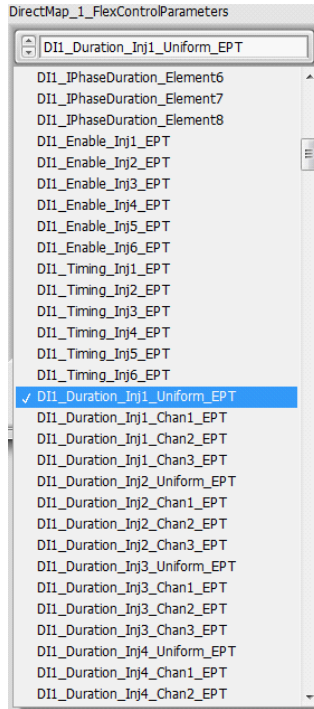

Tip Strip: Selects destination of the CAN signal to be mapped

Detail: A list of Flex Control Parameter selector. It maps the CAN signal list to a Flex Control Parameter. The selected parameter on the Flex Control Parameter list will be overwritten by the CAN signal output value as soon as [CAN_Run](#) is enabled. The rate at which it is written depends on what is defined in the database (see section 4.23.1 for more details). The Flex Control Parameters can be selected one of two ways: by left unclicking and searching through the full list of Flex Control Parameters, shown above, or by right unclicking and searching through a hierarchical list of menus to find the particular Flex Control Parameter of interest, as shown below. A selected flex control parameter cannot be selected twice as it may otherwise lead to double overwriting. When there are duplicate flex control parameters, the entries will be highlighted red and the [CAN_Run](#) button will be disabled.

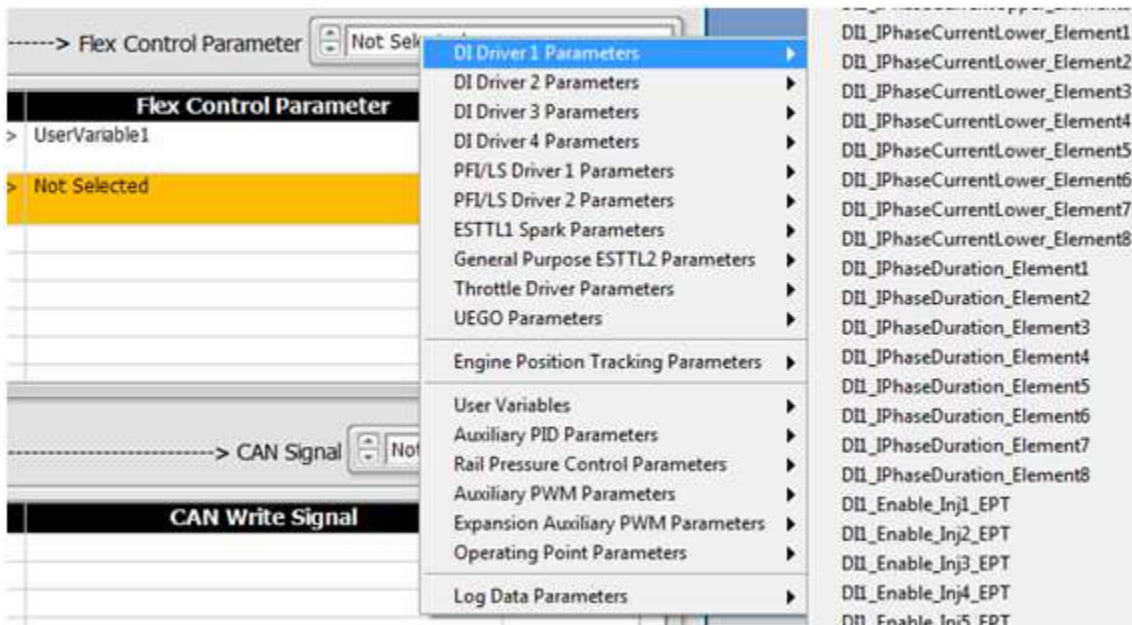

15 Read from CAN Bus Signal List

CAN Read Signal		Flex Control Parameter	Value
Uservariable1 D130.D130	-->	UserVariable1	0.000000
Uservariable2 D130.D130	-->	UserVariable2	0.000000

Detail: A list of mapped CAN Signal to Flex Control Parameter.

Write to CAN Bus

16 Add/Insert

Add / Insert

Tip Strip: Add/Insert item onto the “Write to CAN Bus” List box

Detail: Clicking Add/Insert button to start mapping a variable from the [CalPoints Select](#) list to a variable on the [CAN Signal](#) list. When there are duplicate line items, they will be highlighted red and the [CAN_Run](#) button will be grayed out and disabled.

17 Delete

Delete

Tip Strip: Delete selected item from the “Write to CAN Bus” List box

18 Move Up

Move Up

Tip Strip: Move selected item up the “Write to CAN Bus” List box

19 Move Down

Move Down

Tip Strip: Move selected item down the “Write to CAN Bus” List box

20 CalPoints Select

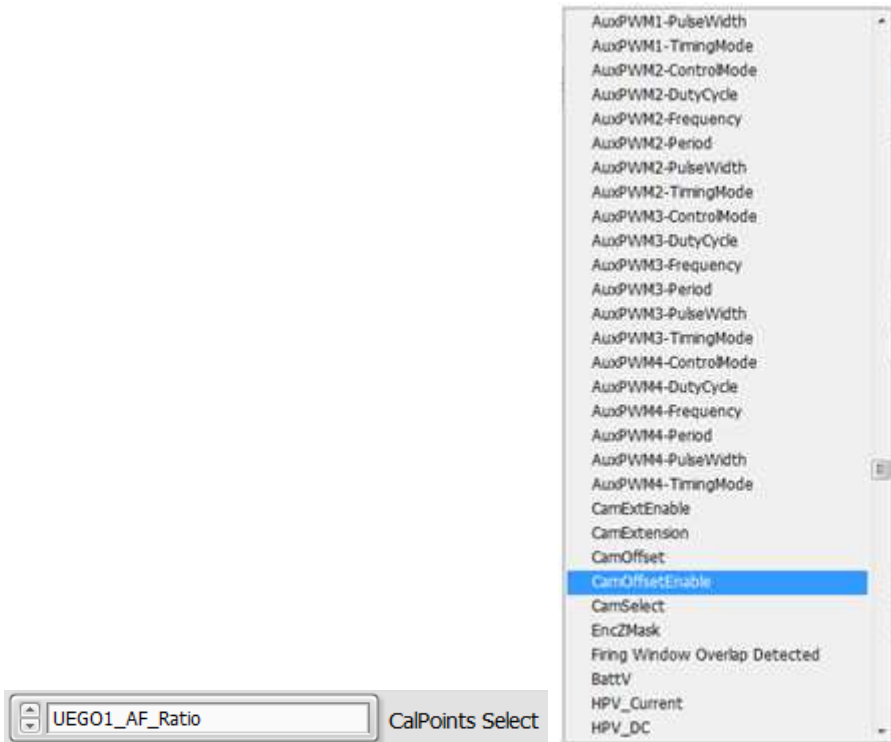

Tip Strip: Assigns signal source to write to a CAN Signal

Detail: Drop-down selection control for selecting the input parameter to be mapped into a CAN Signal. There are more than 1800 parameters in the list. They do not include Tables, Arrays or String characters. This list is different from Process Variable drop-down selection that appears in the Direct Mapping Setup, Table Setup, Auxiliary PID Controller Setup and Operating Point Setup windows.

21 CAN Signal

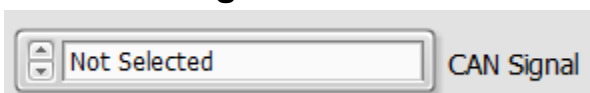

Tip Strip: CAN signal list according to a selected database on the Deployed Databases list

Detail: This list will be populated according to signals defined in the selected database on the controller. No duplicate CAN signals are allowed. As with Flex control parameter, duplicate items will be highlighted red and when there are duplicate [Tx CAN signals](#), the [CAN_Run](#) button will be disabled.

22 Write to CAN Bus Signal List

Process Variable		CAN Write Signal	Value
Engine Speed [RPM]	-->	EngineSpeed D130.D130	0.000000
CrankStalled	-->	CrankStalled D130.D130	0.000000

Detail: A list of mapped CalPoints to CAN Signal.

23 XNET Error

XNET Error	Status	Source
	NO FAULT	
	Code	
	0	

Detail: Reports any XNET error and the associated code and description

4.23.1 NI-XNET Database Editor

The downloaded XNET driver comes with the NI-XNET Database Editor. The purpose of the NI-XNET Database Editor is to create and maintain embedded network databases. The Database Editor is a generic embedded network tool and hence it supports CAN, LIN and FlexRay communication protocols. Since the DI Driver System only supports CAN interface, only CAN communication will be discussed in this document. The database editor comes with a built-in user manual so this document will only touch on relevant features typically used in conjunction with the DI Driver system application.

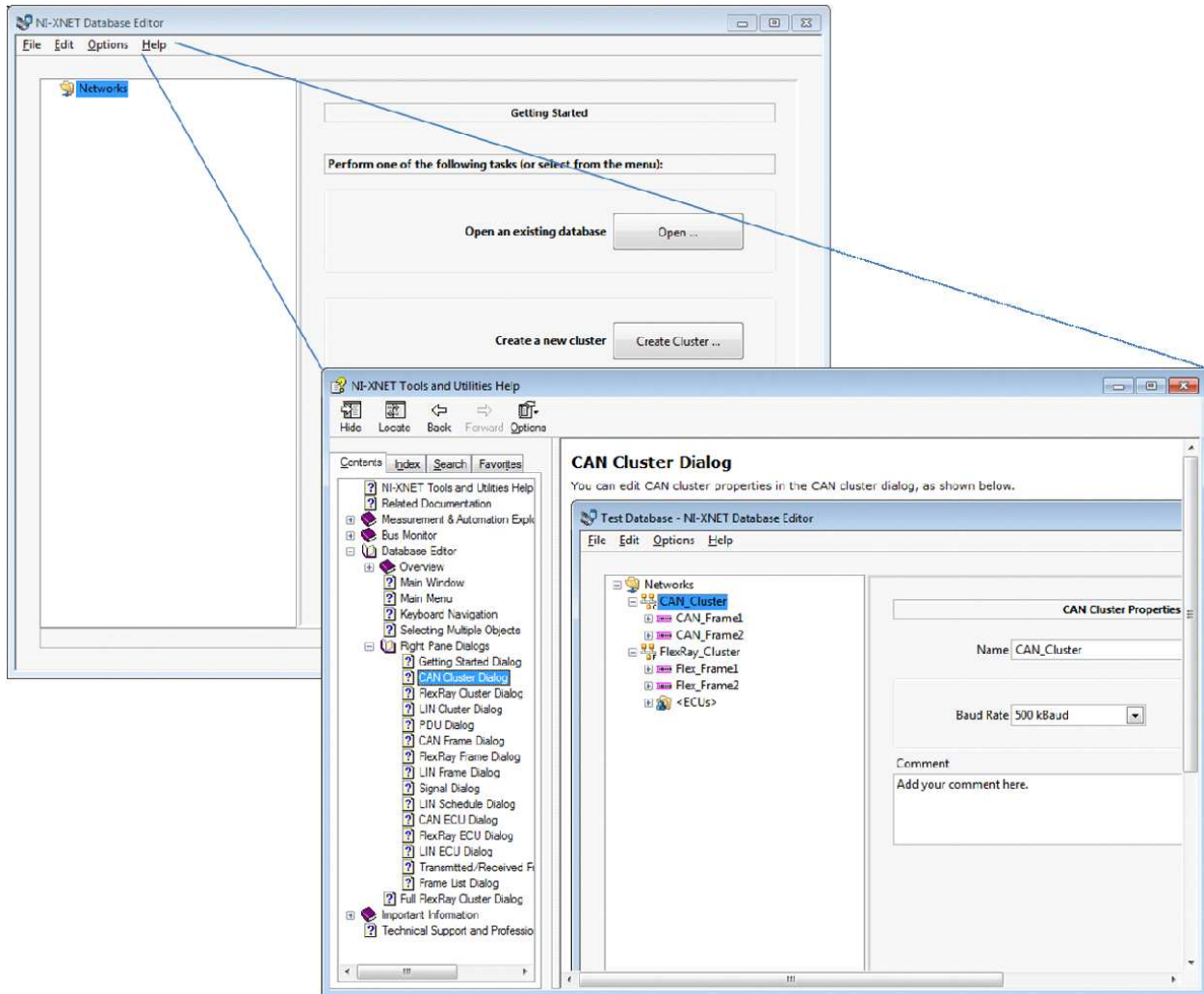

1 Open an existing database

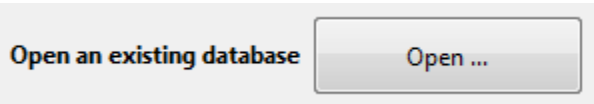

Detail: Click to open an existing database. NI-XNET uses the ASAM FIBEX database storage format. FIBEX (Field Bus EXchange) is a vendor-independent exchange format for embedded network data. It is an XML-based text format. The Database Editor can read and write this format.

In addition, the Database Editor can import the NI-CAN database format (.ncd), vector CANdb format (.dbc), and LIN description file format (.ldf) and convert them to FIBEX.

2 Create a new cluster

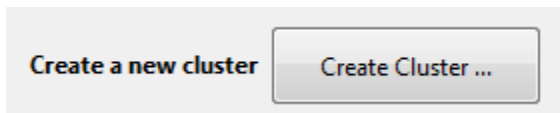

Detail: Click Create Cluster button to create a new database. A cluster is the description of a single network. For CAN, the cluster contains only the baud rate. Usually, a database contains only one cluster. For example, the NI-CAN database and vector CANdb formats support only one cluster. However, FIBEX supports multiple clusters per database; you could, for example, describe all of a vehicle's networks in a single database.

4.23.1.1 CAN Signal Dialog

Signal properties within a cluster can be configured in the Database Editor Signal dialog. Please refer to the Database Editor built-in manual for details of a specific signal property.

Note on Data Type property: You must select Floating Point type given that all variables in the **CalPoint Select** and **Flex Control Parameter** list are of Floating Point type.

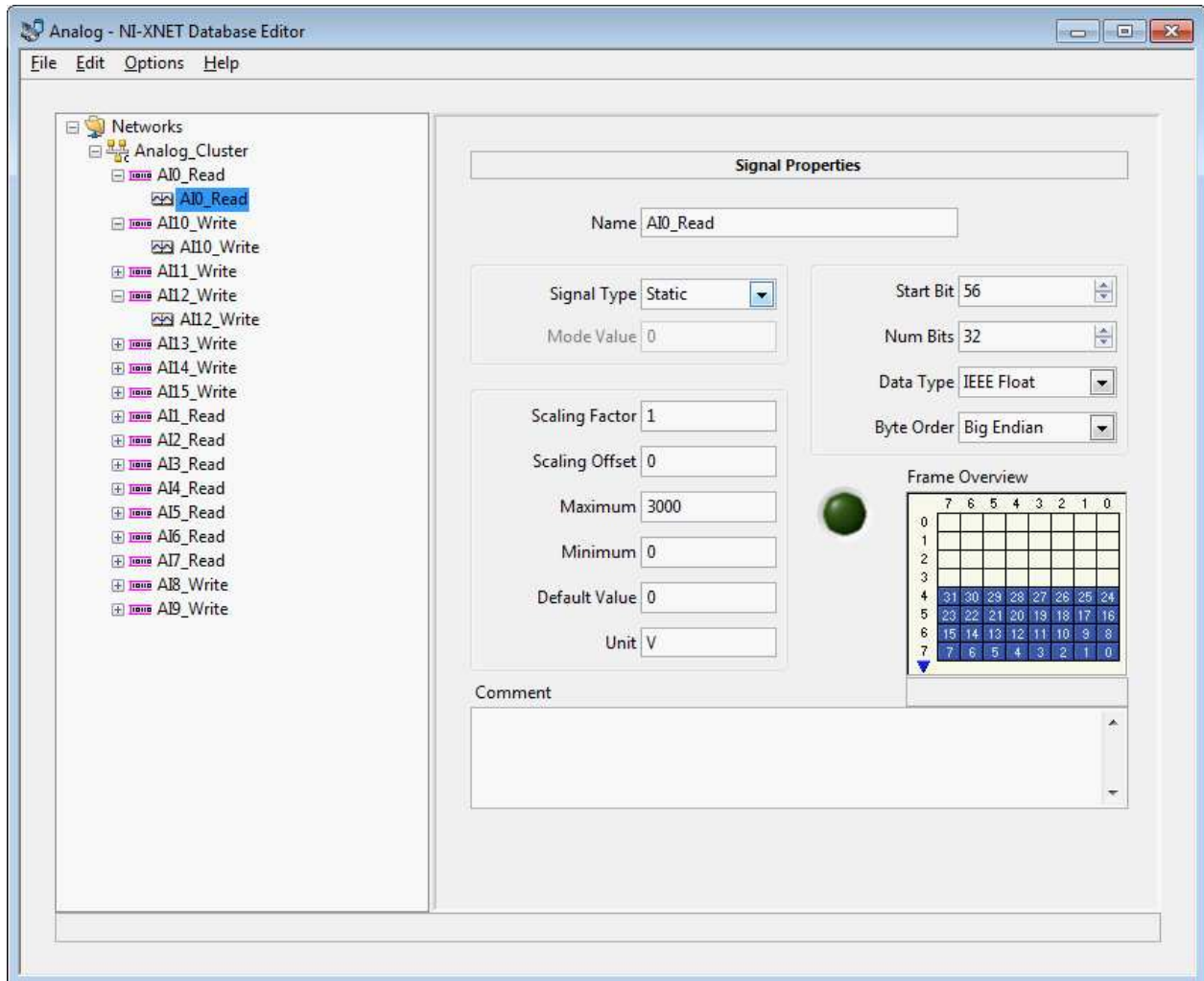

You must create ECUs within a cluster in order for the CAN signals to show up in the XNET CAN Setup Window. Please follow these instructions to create ECUs:

1. Right click on a cluster within a database and select "Create ECU"

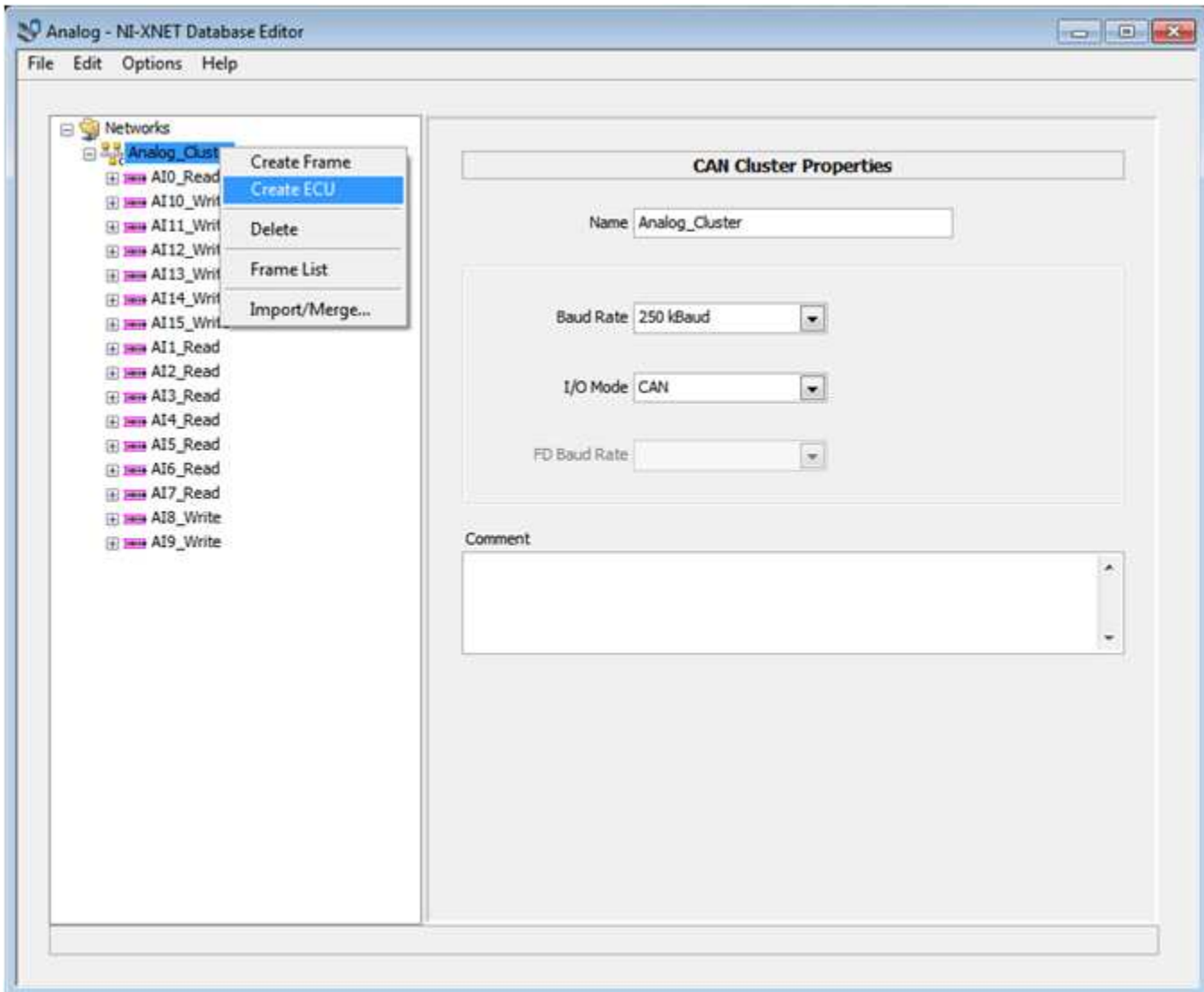

2. Once an ECU is created, you may edit the ECU name and add a comment

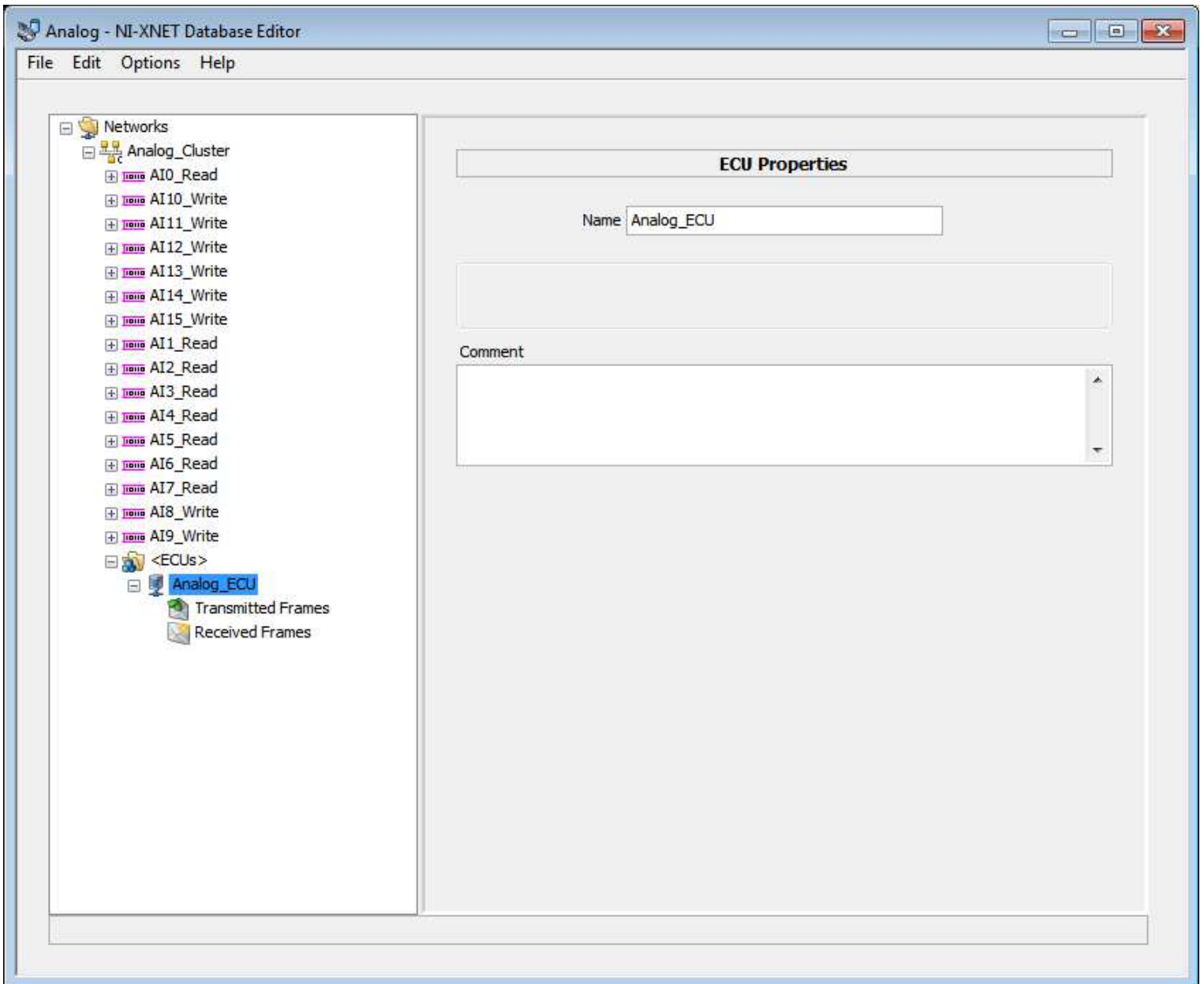

3. Select and assign frames to be transmitted or received by a certain ECU in the Transmitted/Received Frames dialog. You can drag and drop frames from the **Available Frames** list to the **Transmitted Frames** or **Received Frames** lists. The signals on the Transmitted Frames will now appear on the **Write to CAN Bus (Tx) CAN Signal list**. The signals on the Received Frames will now appear on the **Read from CAN Bus (Rx) CAN Signal list**. The same ECU cannot transmit and receive a frame; therefore, each frame can appear in only one list. Click the appropriate list header to specify whether the frame lists are sorted by name or ID.

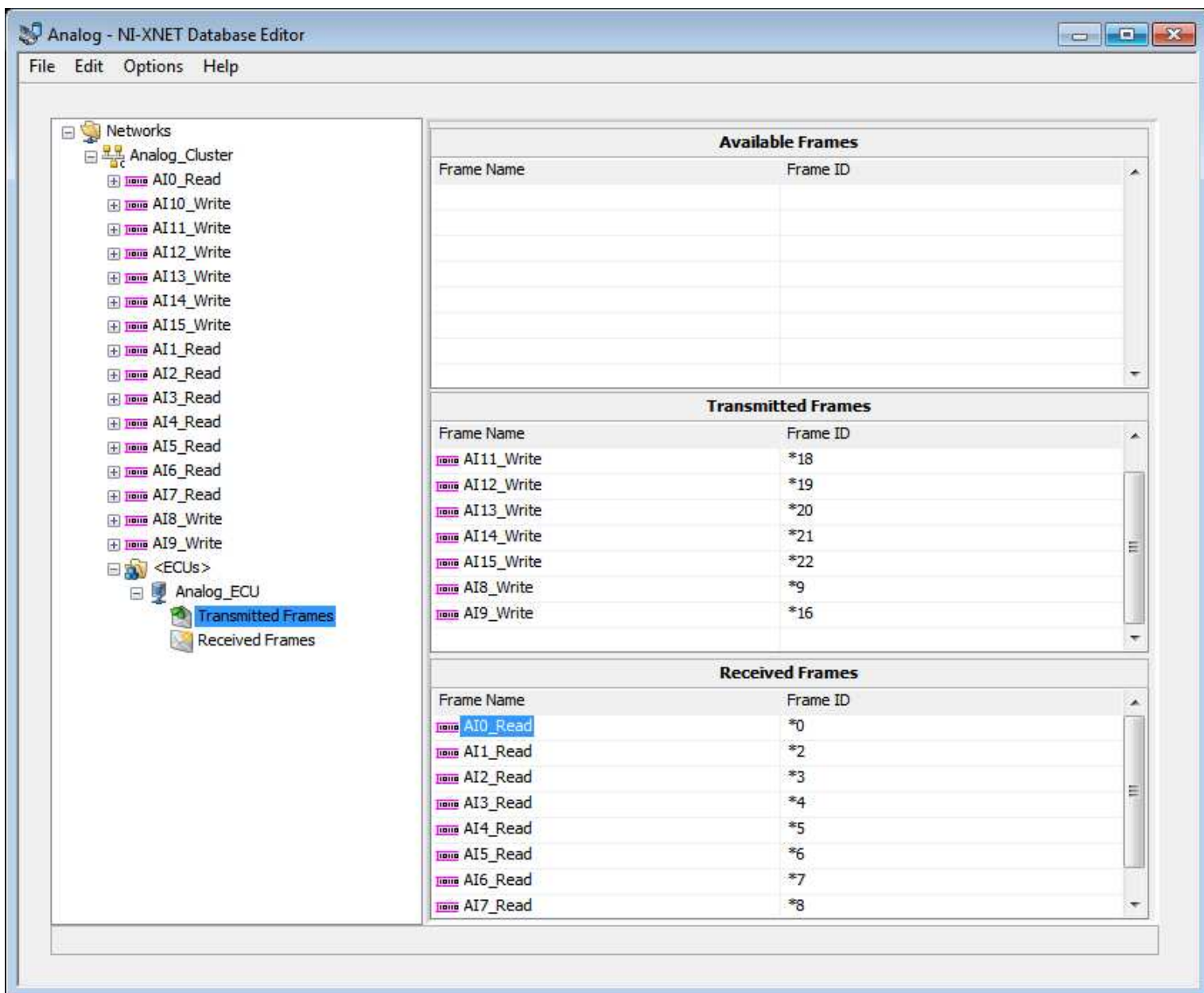
 Analog - NI-XNET Database Editor
 File Edit Options Help

Networks
 Analog_Cluster
 + AI0_Read
 + AI10_Write
 + AI11_Write
 + AI12_Write
 + AI13_Write
 + AI14_Write
 + AI15_Write
 + AI1_Read
 + AI2_Read
 + AI3_Read
 + AI4_Read
 + AI5_Read
 + AI6_Read
 + AI7_Read
 + AI8_Write
 + AI9_Write
 <ECUs>
 Analog_ECU
 Transmitted Frames
 Received Frames

Available Frames
 Frame Name Frame ID

Frame Name	Frame ID

Transmitted Frames
 Frame Name Frame ID

Frame Name	Frame ID
AI11_Write	*18
AI12_Write	*19
AI13_Write	*20
AI14_Write	*21
AI15_Write	*22
AI8_Write	*9
AI9_Write	*16

Received Frames
 Frame Name Frame ID

Frame Name	Frame ID
AI0_Read	*0
AI1_Read	*2
AI2_Read	*3
AI3_Read	*4
AI4_Read	*5
AI5_Read	*6
AI6_Read	*7
AI7_Read	*8

4.23.1.2 Manage NI-XNET Databases Dialog

Another helpful tool within the Database Editor is the Manage NI-XNET Databases Dialog tool which can be used to create and delete database aliases and to deploy and undeploy databases to your DI Driver System controller.

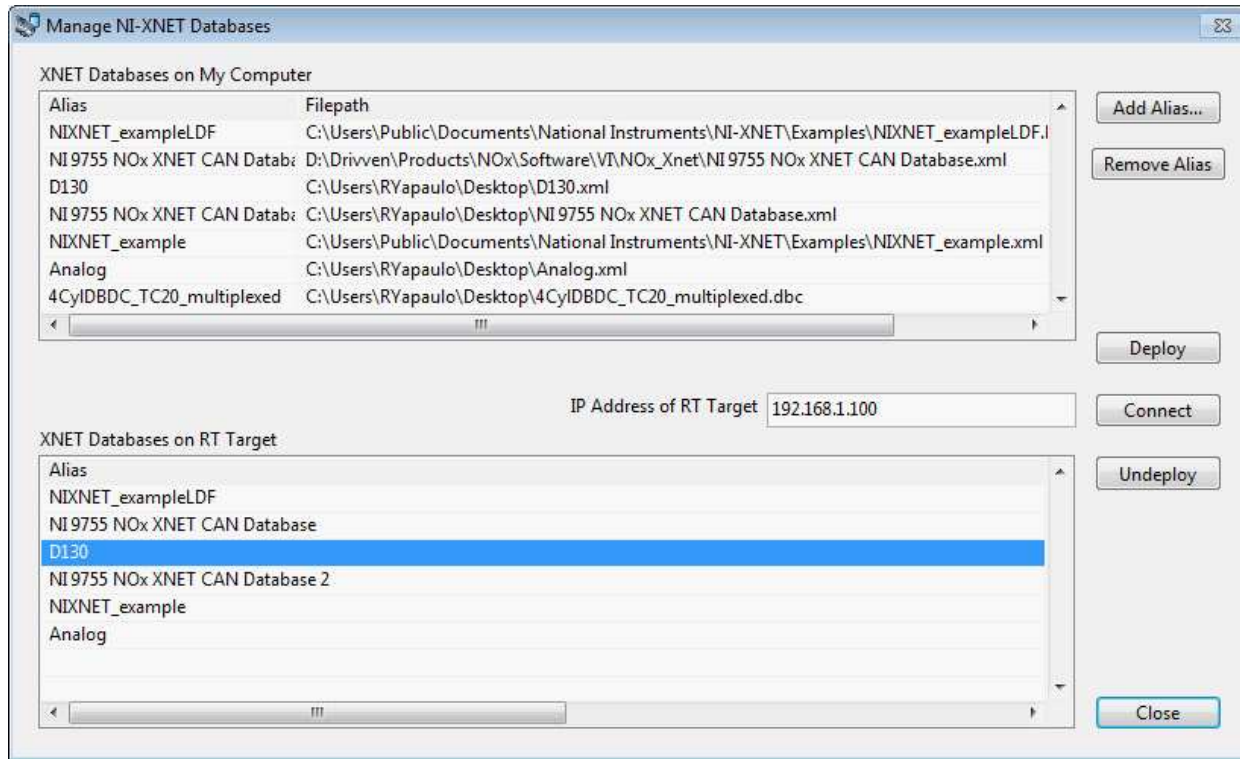

1 Add Alias

Add Alias...

Detail: Click to browse to a database file on the Windows PC and assign an alias name that will be associated to that database

2 Remove Alias

Remove Alias

Detail: Remove Alias on the list of recognized database on the Windows PC. You must select a database to remove. You can select multiple entries by holding the <Shift>+<left –click> key for a range of entries or holding the <Ctrl>+<left –click> for multiple single entries.

Alias	Filepath
NIXNET_exampleLDF	C:\Users\Public\Documents\National Instruments\NI-XNET\Examples\NIXNET_exampleLDF.
NI 9755 NOx XNET CAN Datab: D130	D:\Drivven\Products\NOx\Software\VI\NOx_Xnet\NI 9755 NOx XNET CAN Database.xml
NI 9755 NOx XNET CAN Datab: D130	C:\Users\RYapaulo\Desktop\D130.xml
NI 9755 NOx XNET CAN Datab: D130	C:\Users\RYapaulo\Desktop\NI 9755 NOx XNET CAN Database.xml
NIXNET_example	C:\Users\Public\Documents\National Instruments\NI-XNET\Examples\NIXNET_example.xml
Analog	C:\Users\RYapaulo\Desktop\Analog.xml
4CylDBDC_TC20_multiplexed	C:\Users\RYapaulo\Desktop\4CylDBDC_TC20_multiplexed.dbc

3 IP Address of RT Target/Connect

IP Address of RT Target

Detail: To deploy/undeploy databases to the controller, enter the IP Address of the DI Driver System controller you are interfacing to and click the **Connect** button.

4 Deploy

Detail: Clicking this button will deploy selected database on the Windows PC to the controller.

5 UnDeploy

Detail: Clicking this button will undeploy selected database from the controller.

Note: If a database on the controller is active (i.e. if it is selected on the DI Driver System XNET CAN Setup Window), you cannot undeploy the database. If you attempt to undeploy an active database, you will get an error message that indicates that it is currently being accessed. When this happens, unselect the database or set it to 'No Database Selected' on the [Deployed Databases](#) list on the XNET CAN Setup window and retry the Undeploy operation on the Manage NI-XNET Databases Dialog window.

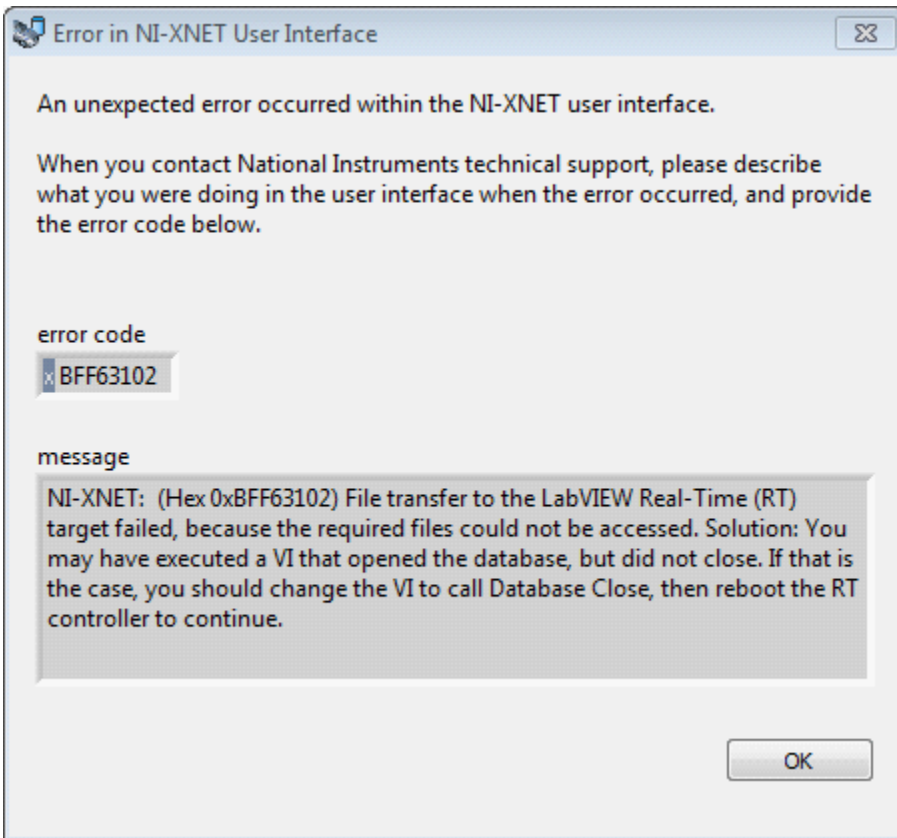

4.24 TDK HV Supply Control Setup Window

The purpose of the TDK HV Supply Control Setup window is to remotely configure the TDK High Voltage Power Supply (via cabling shown below) for providing external high voltage power supply to the DI Driver module(s) – pins 7 and 8 on the DI Driver connector. The DB9 to RJ45 cable pin-out is shown below according to the TDK power supply manual downloadable from TDK website.

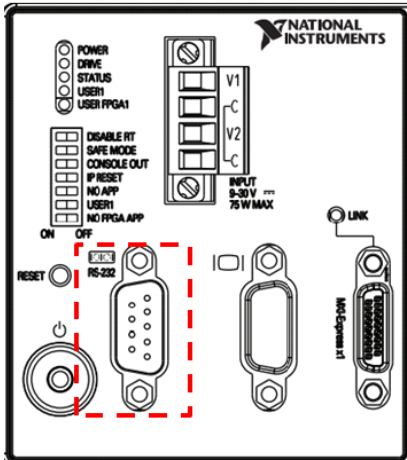

**cRIO 9082
RS232 serial
connector**

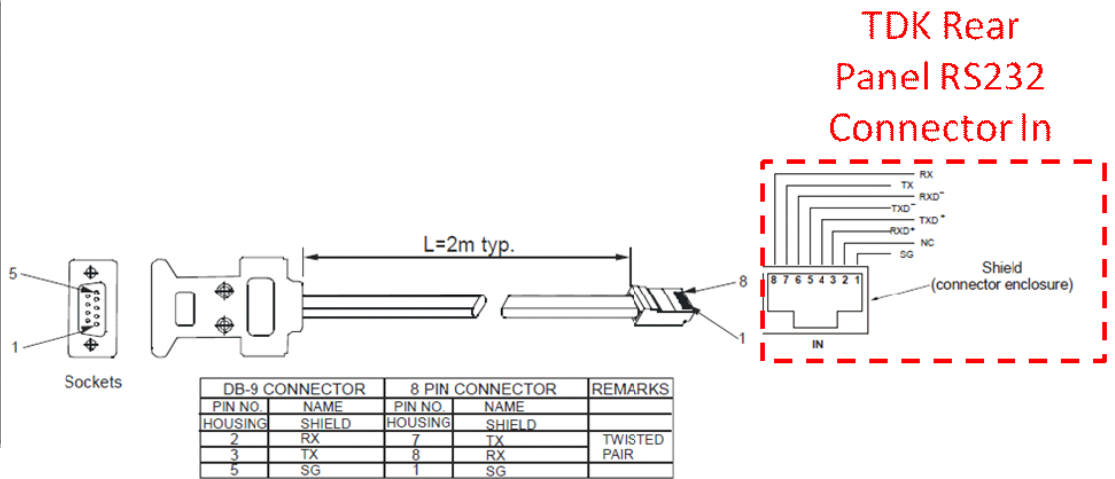
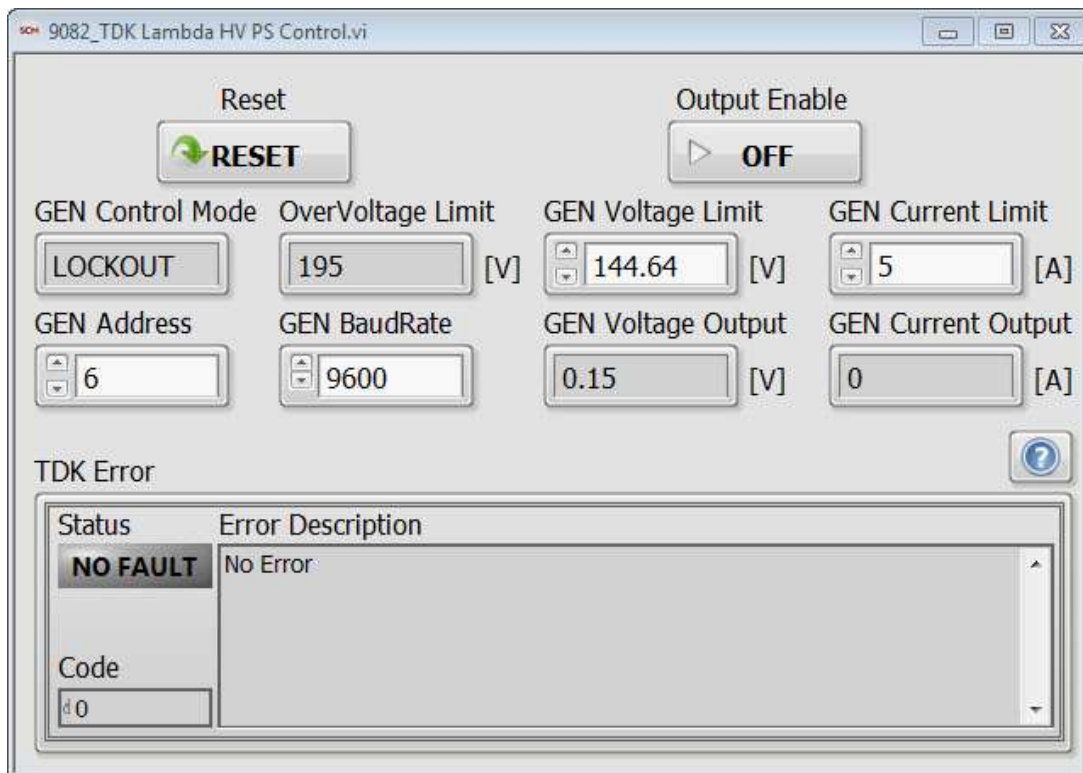
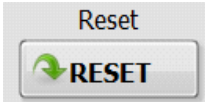

Fig.7-3: RS232 cable with DB9 connector (P/N: GEN/232-9)



1 Reset



Tip Strip: Resets TDK High Voltage power supply

2 GEN Control Mode

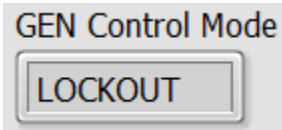

Tip Strip: Indicates TDK High Voltage Power Supply Control Mode

Detail: By default the TDK supply control mode should be in LOCKOUT mode which means the device front panel will be inoperable.

3 OverVoltage Limit

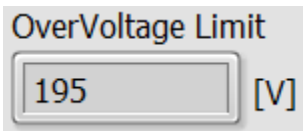

Tip Strip: TDK Genesys Power High Voltage Power Supply OverVoltage Protection

Detail: The OverVoltage limit is set to 195V. The external high voltage supply to be applied to the DI Driver module is limited to 190V and thus the limit on the **GEN Voltage Limit** parameter. This should give enough room for the user to operate up to 190V without error.

4 GEN Address

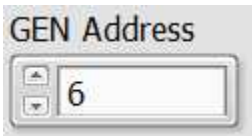

Tip Strip: TDK Genesys Power Supply instrument address

Detail: By default the TDK supply instrument address is set to 6.

5 GEN BaudRate

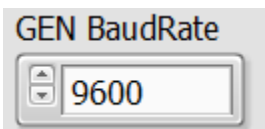

Tip Strip: TDK Genesys Power Supply instrument RS232 serial communication baud rate (Default = 9600)
Detail: By default, the serial communication with the instrument is set to 9600.

6 Output Enable

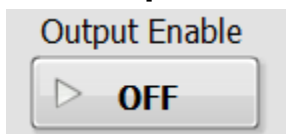

Tip Strip: Enables Current output on the TDK Lambda High Voltage Supply

7 GEN Voltage Limit

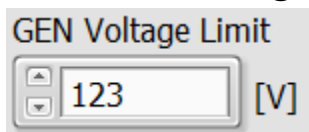

Tip Strip: TDK Genesys Power Supply Voltage Limit.

Detail: This parameter is part of FlexControlParameter list and thus can be overwritten by a table, Auxiliary PID Controller, external CAN Variable or User Variable.

8 GEN Current Limit

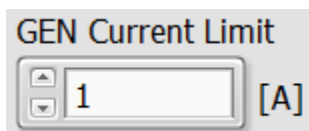

Tip Strip: TDK Genesys Power Supply Current Limit

Detail: This parameter is part of FlexControlParameter list and thus can be overwritten by a table, Auxiliary PID Controller, external CAN Variable or User Variable.

9 GEN Voltage Output

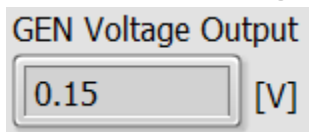

Tip Strip: Indicates TDK Genesys High Voltage Power Supply Voltage Output

10 GEN Current Output

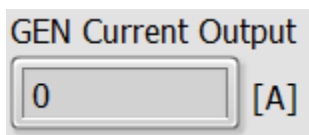

Tip Strip: Indicates TDK Genesys High Voltage Power Supply Current Output

11 TDK Error

Status	Error Description
NO FAULT	No Error
Code	
0	

Tip Strip: Indicates error associated with TDK Genesys High Voltage Power Supply communication or current/voltage control.

4.25 Active Flex Control Parameters Window

The purpose of the Active Flex Control Parameters window is to show, within a single window, any Flex Control Parameters that are selected to be written by one of the DI Driver System software functions. Flex Control Parameters may be selected within the various setup windows, but the function may be optionally enabled or disabled. The green LED for each parameter indicates whether the parameter is actively being written by the function. For example, the screen shot in Figure 4.24.a shows that the 1D-Table 1 output, which is configured via the [Table Setup](#) window, is actively writing to the PFI_Duration_Chan1_EPT Flex Control Parameter because the table is enabled. The SimulatedSpeed Flex Control Parameter is also selected to be written by the 1D-Table 2 function, but the table is not enabled, and is not actively writing the parameter.



Figure 4.25.a, Active Flex Control Parameters

4.26 CalScopes Window

The purpose of the CalScopes window is to configure up to eight oscilloscope-like displays for monitoring various software variables within the DI Driver System. This is an advanced feature which is documented within the [SCM user manual](#).

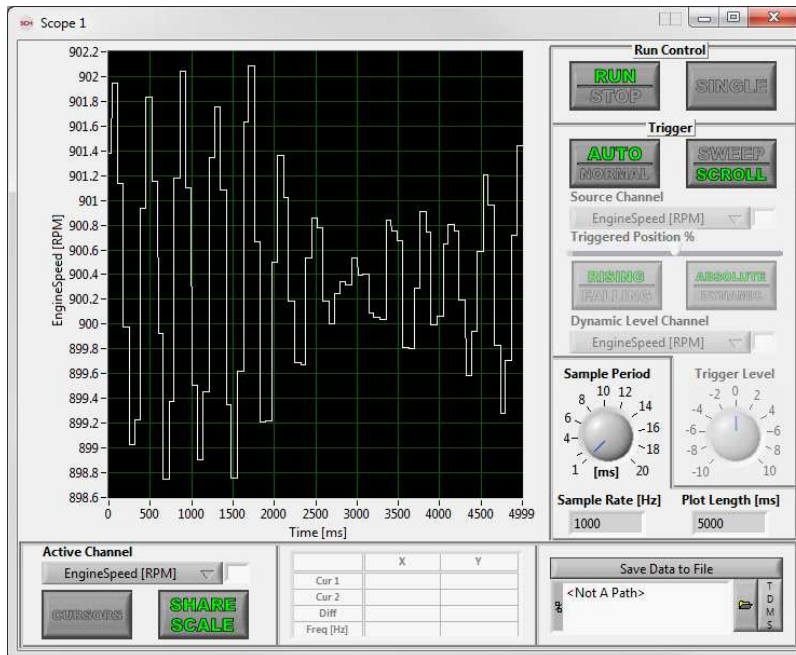
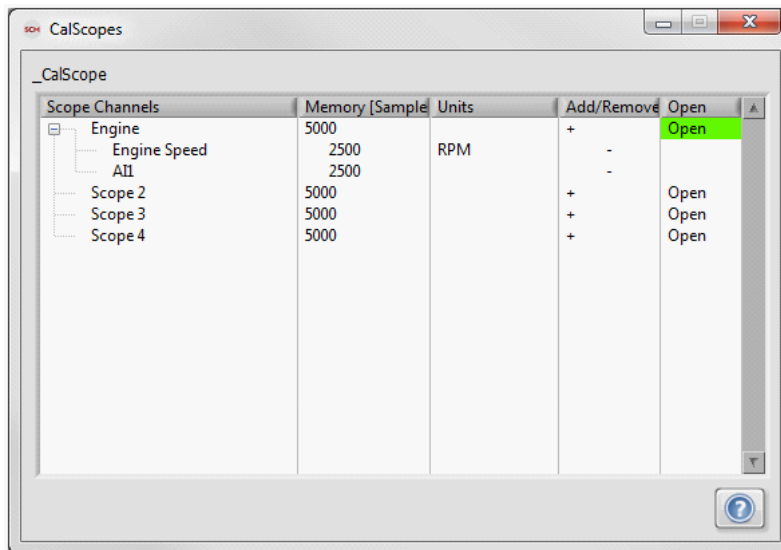

4.27 CalTrend Window

The purpose of the CalTrend window is to configure up to eight multi-variable plot windows for monitoring various software variables within the DI Driver System. This is an advanced feature which is documented within the [SCM user manual](#).

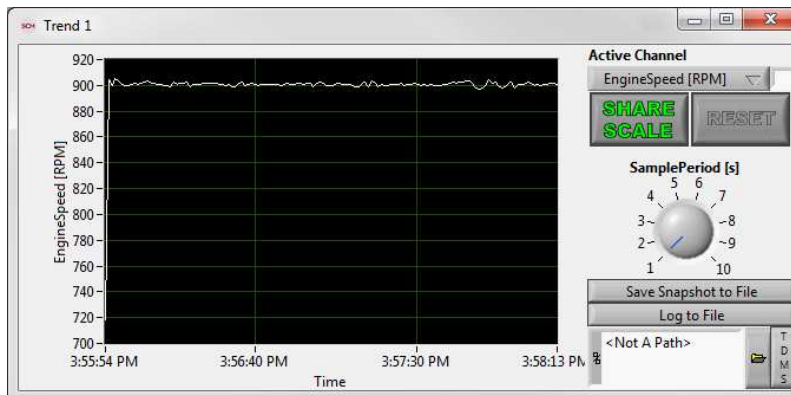
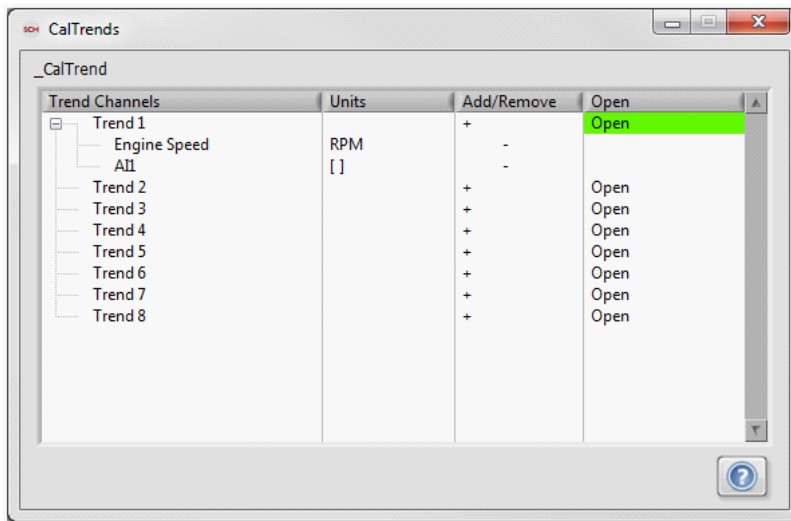

4.28 Log Data Setup Window

The purpose of the Log Data Setup window is to configure data logging of a variety of DI Driver System software parameters to a text file, stored on the cRIO controller file system. The data files are NOT able to be logged over the network to another computer. After the data logging is completed, the data file may be copied to another computer via File Transfer Protocol (FTP) connection over the network. Options for logging data include Sample Period, RAM Buffer Size, Stop Trigger, Filename Suffix, and Data Delimiter. The variables to be logged are specified in an array of drop-down selection lists. A logging parameter plot is available within the window and parameters may be individually selected for plotting.

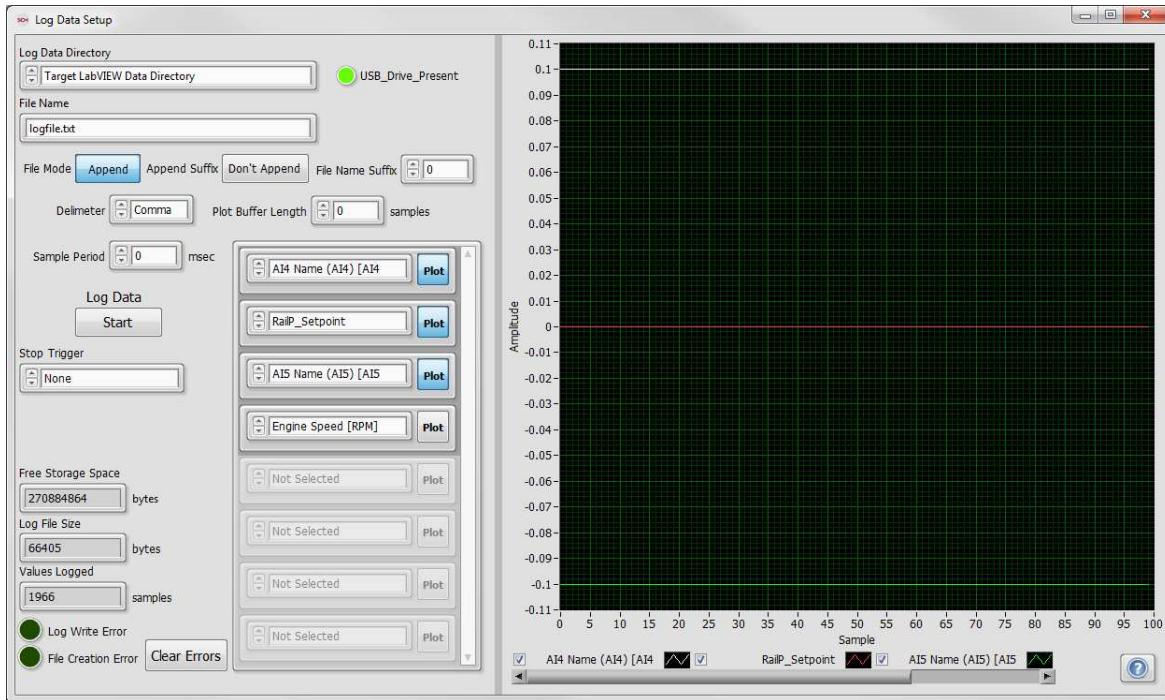

1 File Path

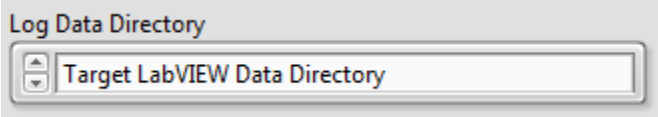

Tip Strip: Location to save log data

Detail: Specifies the location on the cRIO controller where the log file will be saved. Two choices are available: **Target LabVIEW Data Directory** and **USB Storage Device**. If **Target LabVIEW Data Directory** is selected, then the file can be retrieved via an FTP browser from the location "c:\ni-rt\LabVIEW Data". (DI Driver Systems based on the cRIO-9022 and cRIO-9076 have their LabVIEW Data directories located at the same location; DI Driver Systems based on the cRIO-9066 have their LabVIEW Data directories located at "/home/lvuser/natinst/LabVIEW Data".) File Paths starting with c:\ indicates that the log file will be saved to the cRIO controller local hard drive. Data files can optionally be stored to a USB storage device if connected via the USB port on the cRIO controller front panel. Typically, a USB storage device will be shown in the controller file browser as u:\.

2 File Mode

File Mode

Tip Strip: Select to append new data to existing file data

Detail: When set to **Append**, causes the [Log Data](#) function to append data to an existing file specified in the [File Path](#). When set to **Overwrite**, causes the [Log Data](#) function to create a new file for the data, overwriting any existing file.

3 Append Suffix

Append Suffix

Tip Strip: Select to append suffix to file name

Detail: Determines whether the numerical suffix specified in [File Name Suffix](#) is appended to the filename.

4 File Name Suffix

File Name Suffix

Tip Strip: Suffix to append to file name

Detail: Specifies the numerical suffix to append to the filename if [Append Suffix](#) is set to **Append**.

5 Delimiter

Delimiter Comma
 Tab
 Colon

Tip Strip: Text file delimiter between data points

Detail: Selects one of three delimiters to use for separating data in the text log file. The options are **Comma**, **Tab** or **Colon**.

6 Plot Buffer Length

Plot Buffer Length samples

Tip Strip:

Units: samples

Detail: Specifies the number of samples to plot in the plot area to the right of the window.

7 Sample Period



Tip Strip: Should be in multiples of 50 msec

Units: msec

Detail: Specifies the time interval for sampling the values of the parameters specified in [Variables to Log](#).

8 Log Data

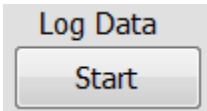

Tip Strip: Enables logging of selected parameters

Detail: Enables or disables data logging.

9 Stop Trigger

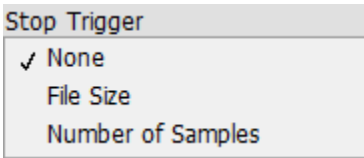

Tip Strip: Selects the method by which the data logging is stopped or continued if set to None.

Detail:

None: Data logging is started and stopped via [Log Data](#).

File Size: Data logging is stopped when the file size reaches the value specified by [Max Log File Size](#).

Number of Samples: Data logging is stopped when the number of logged samples reaches the value specified by [Max Log Samples](#).

The appropriate [Stop Trigger](#) parameter will be shown according to the trigger method selected.

Max Log File Size



Units: bytes

Detail: When [Stop Trigger](#) is set to **File Size**, data logging is stopped when the file size reaches the value specified by [Max Log File Size](#).

Max Log Samples



Units: samples

Detail: When [Stop Trigger](#) is set to **Number of Samples**, data logging is stopped when the number of logged samples reaches the value specified by [Max Log Samples](#).

10 Free Storage Space

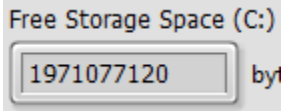

Detail: Local drive space (c:\) available for data storage.
Units: bytes

11 Log File Size

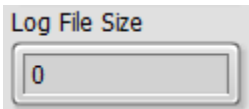

Tip Strip: Size of log file
Units: bytes
Detail: Indicates the current file size of the log file in process.

12 Values Logged

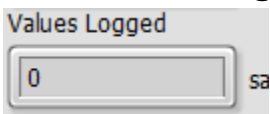

Tip Strip: Number of samples logged
Units: samples
Detail: Indicates the current number of samples logged to the log file in process.

13 Log Write Error

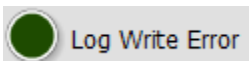

Tip Strip: Error encountered writing to log file
Detail: Set to **TRUE** when an error is encountered during the data logging process, such as insufficient memory available.

14 File Creation Error

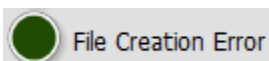

Tip Strip: File creation error
Detail: Set to **TRUE** when an error is encountered during log file creation.

15 Clear Errors

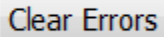
A rectangular button with a light gray background and a thin border, containing the text "Clear Errors" in a standard sans-serif font.

Tip Strip: Select to clear log file fault

Detail: Clears the error indicated by [Log Write Error](#) or [File Creation Error](#) LEDs.

16 Variables to Log

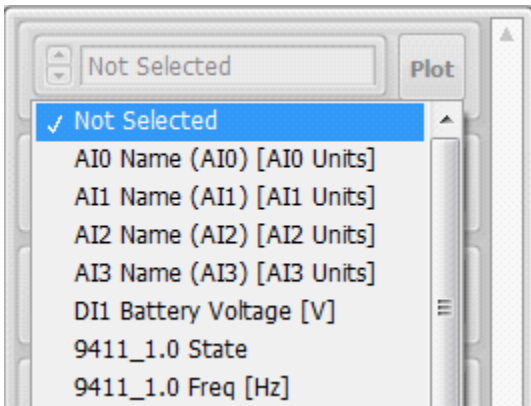

Detail: The variables to be logged are specified in an array of drop-down selection lists. A logging parameter plot is available within the window and parameters may be individually selected for plotting.

17 Log Scope

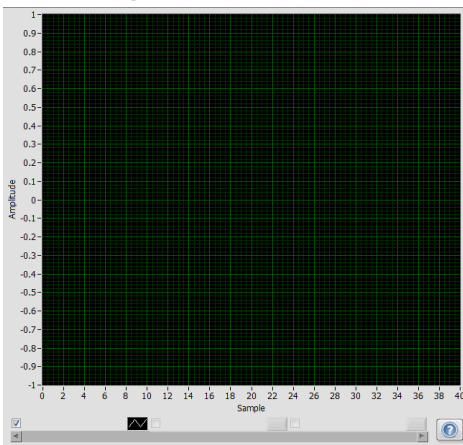

Detail: Plot of selected [Variables to Log](#)
Units: samples

4.29 Faults Window

The purpose of the Faults window is to show the status of each fault within the DI Driver System. The faults are displayed in alphabetical order.

Hide Inactive Faults	Very Low	14	Key Cycle	Ack All	Clr All	0	Very Low	0	Low	0	Medium	0	High	0	Very High
Fault Point	Description	Count	Up Rate	Down Rate	Thresh	Severity	Sticky	Sticky Time	Sticky Cycle	Fault Time	Fault Cycle	Clear Time	Trip Count*	Disable**	
D DI1 F11_OpenCrcuit		0	1	1	1	Very Low	-	-	12/31/1	0	8:57:00	0			
D DI1 F12_OpenCrcuit		0	1	1	1	Very Low	-	-	12/31/1	0	8:57:00	0			
D DI1 F13_OpenCrcuit		0	1	1	1	Very Low	-	-	12/31/1	0	8:57:00	0			
D DI1 HV_Limit		0	1	1	1	Very Low	-	-	12/31/1	0	8:57:00	0			
D DI1 HighVoltageDrive		0	1	1	1	Very Low	-	-	12/31/1	0	8:57:00	0			
D DI1 LowVoltageDrive		0	1	1	1	Very Low	-	-	12/31/1	0	8:57:00	0			
D DI1 ModuleTemp		0	1	1	1	Very Low	-	-	12/31/1	0	8:57:00	0			
D DI1 PS_Charge		0	1	1	1	Very Low	-	-	12/31/1	0	8:57:00	0			
D DI1 PS_OverLoad		0	1	1	1	Very Low	-	-	12/31/1	0	8:57:00	0			
D DI1 Short_Circuit		0	1	1	1	Very Low	-	-	12/31/1	0	8:57:00	0			
D DI2 F11_OpenCrcuit		0	1	1	1	Very Low	-	-	12/31/1	0	8:57:00	0			
D DI2 F12_OpenCrcuit		0	1	1	1	Very Low	-	-	12/31/1	0	8:57:00	0			
D DI2 F13_OpenCrcuit		0	1	1	1	Very Low	-	-	12/31/1	0	8:57:00	0			
D DI2 HV_Limit		0	1	1	1	Very Low	-	-	12/31/1	0	8:57:00	0			
D DI2 HighVoltageDrive		0	1	1	1	Very Low	-	-	12/31/1	0	8:57:00	0			
D DI2 LowVoltageDrive		0	1	1	1	Very Low	-	-	12/31/1	0	8:57:00	0			
D DI2 ModuleTemp		0	1	1	1	Very Low	-	-	12/31/1	0	8:57:00	0			
D DI2 PS_Charge		0	1	1	1	Very Low	-	-	12/31/1	0	8:57:00	0			
D DI2 PS_OverLoad		0	1	1	1	Very Low	-	-	12/31/1	0	8:57:00	0			
D DI2 Short_Circuit		0	1	1	1	Very Low	-	-	12/31/1	0	8:57:00	0			
D DI3 F11_OpenCrcuit		0	1	1	1	Very Low	-	-	12/31/1	0	8:57:00	0			
D DI3 F12_OpenCrcuit		0	1	1	1	Very Low	-	-	12/31/1	0	8:57:00	0			
D DI3 F13_OpenCrcuit		0	1	1	1	Very Low	-	-	12/31/1	0	8:57:00	0			
D DI3 HV_Limit		0	1	1	1	Very Low	-	-	12/31/1	0	8:57:00	0			
D DI3 HighVoltageDrive		0	1	1	1	Very Low	-	-	12/31/1	0	8:57:00	0			

Double click a fault to acknowledge it, Double click again to clear it. *Double click a fault in specified column to change the value.

1 Hide Inactive Faults

Hide Inactive Faults

Detail: Filters the fault list to show only active faults.

2 Fault Severity

Very Low 4

- ✓ Very Low
- Low
- Medium
- High
- Very High

Detail: Filters the fault list to show only the faults registered with the specified severity.

3 Key Cycle

14 Key Cycle

Detail: Indicates the number of times the system power has been cycled.

4 Ack All

Ack All

Detail: Acknowledges all active faults.

5 Clr All

Clr All

Detail: Clears all active faults.

6 Fault Count

0 Very Low 0 Low 0 Medium 0 High 0 Very High

Detail: Indicates the number of active faults within each severity category.

7 Fault Point

Fault Point

Detail: The name assigned to the fault.

8 Description

Description

Detail: The description registered with the fault.

9 Count

Count

Detail: Indicates the number of times a fault has occurred. Value resets to 0 when fault is acknowledged and cleared.

10 Up Rate

Up
Rate

Detail: The rate at which the fault counter is incremented while the fault condition is present.

11 Down Rate

Down
Rate

Detail: The rate at which the fault counter is decremented while the fault condition is not present.

12 Thresh



Detail: The fault counter threshold at which the fault is active.

13 Severity



Detail: Shows the severity of the fault.

14 Sticky



Detail: Indicates whether the fault is register as Sticky. When registered as Sticky, the fault will remain active for the time shown in Sticky Time.

15 Sticky Time



Detail: Indicates the amount of time a fault will remain active, after the fault condition is removed.

16 Sticky Cycle



Detail: Indicates the number of Key Cycles the fault will remain active, after the fault condition is removed.

17 Fault Time

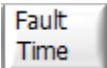

Detail: Indicates the date and time of the last occurrence of the fault.

18 Fault Cycle

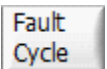

Detail: Indicates the number of Key Cycles since the fault condition was removed.

19 Clear Time

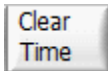

Detail: Indicates the date and time when the fault was last cleared.

20 Trip Count



Detail: Double clicking on the cell related to the fault in the "Trip Count" column will clear that fault's trip count.

21 Disable

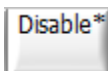

Detail: Double clicking the "Disable" cell associated with the fault will disable the fault from becoming active, even if the fault condition is present.

4.30 Execution Information Window

The purpose of the Execution Information window is for diagnostic purposes. It is divided into four tabs titled [Static Info](#), [Network](#), [Run-Time Info](#) and [Expansion/Misc. Execution Info](#). The first tab shows information about system configuration. The second tab is used to change the system controller network interface settings. The third and fourth tab shows software processes.

4.30.1 Static Info

The Static Info Tab of the Execution Information window displays configuration information for the DI Driver System.

The screenshot shows the 'Execution Information' window with the 'Static Info' tab selected. The window contains several input fields and labels for configuration parameters. At the bottom, there is a status indicator showing 'NO ERROR' and 'FPGAError', and a help icon.

Field	Label
192.168.1.100	Target IP Address
DefaultCal	CalFile Name
NI-DIDS-2F131F17	Target Name
cRIO-9082	Controller Model
9082	Chassis Model
3.140.F5.9082.14550b	Software Version
14.0.0	SCM Build
12	DI Driver System Size
<input type="checkbox"/>	DI1 Module Revision
<input type="checkbox"/>	DI2 Module Revision
<input type="checkbox"/>	DI3 Module Revision
<input type="checkbox"/>	DI4 Module Revision
<input type="checkbox"/>	PFI Module Revision
<input type="checkbox"/>	PFI2 Module Revision
2F131F17	DI Driver System Serial Number

● Activated

NO ERROR FPGAError

4.30.2 Network

The Network tab of the Execution Information window displays the current network settings of the controller and allows the network settings to be changed.

Execution Information

Static Info Network Run-Time Info Expansion/Misc. Execution Info

Current Network Status

192.168.1.100 IP Address

255.255.0.0 Subnet Mask

255.255.255.255 Default Gateway

0.0.0.0 DNS Server

IP Address Settings

Obtain an IP address automatically

Use the following settings:

192.168.1.100 IP Address

255.255.0.0 Subnet Mask

255.255.255.255 Default Gateway

0.0.0.0 DNS Server

Apply Change

You must reboot the DI Driver System for this change to take effect. Note, you will also need to find the target again in SCM

NI-DIDS-2F131F17 Target Name

Apply Change

?

4.30.3 Run-Time Info

The Run-Time Info tab of the Execution Information window displays the execution time of various software processes and parameters related to the controller hardware.

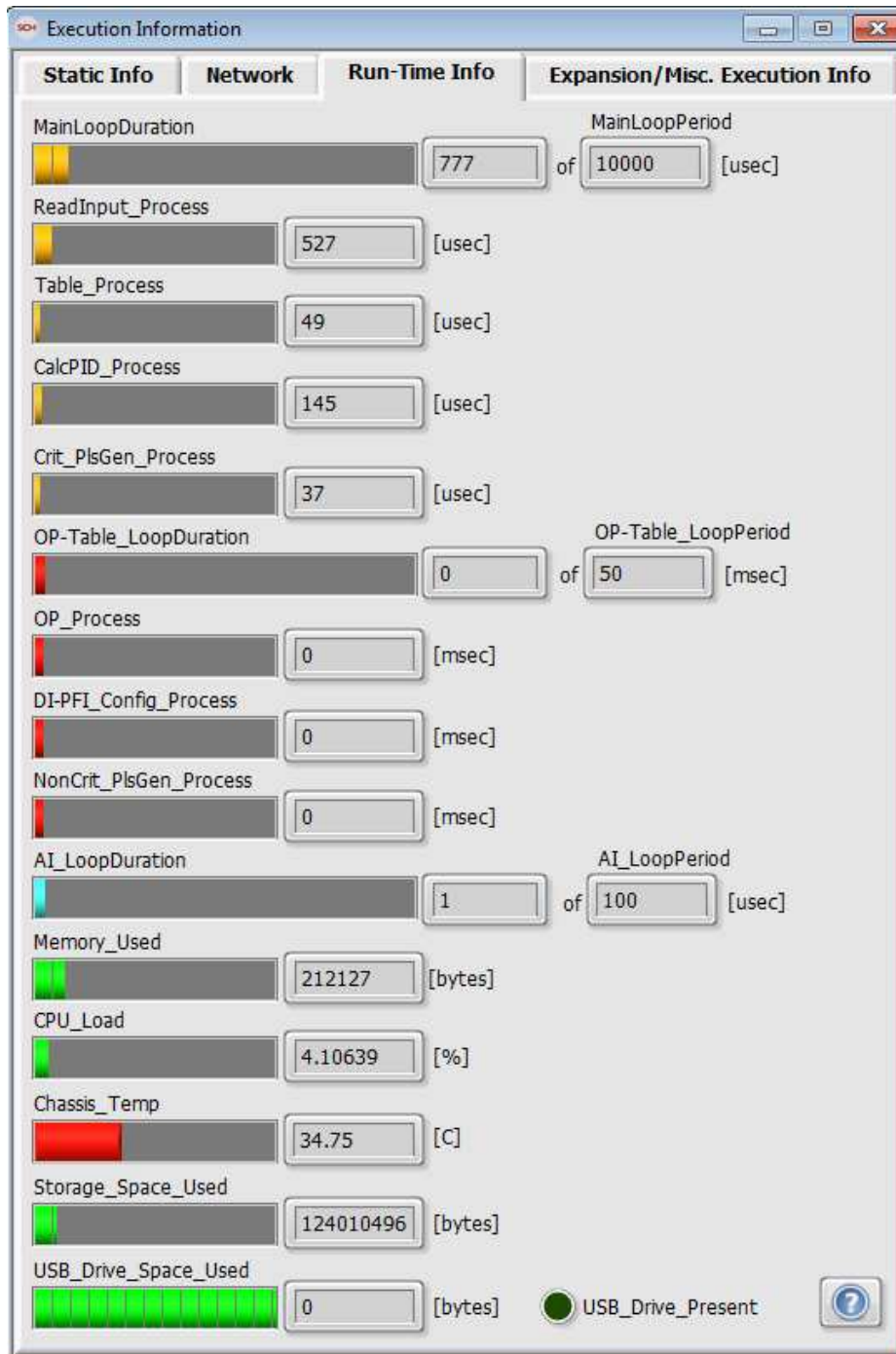

4.30.4 Expansion/Misc. Execution Info

The Expansion Execution Info tab of the Execution Information window displays the execution time of various software processes and parameters related to the Inputs/Outputs on the MXIe expansion chassis.

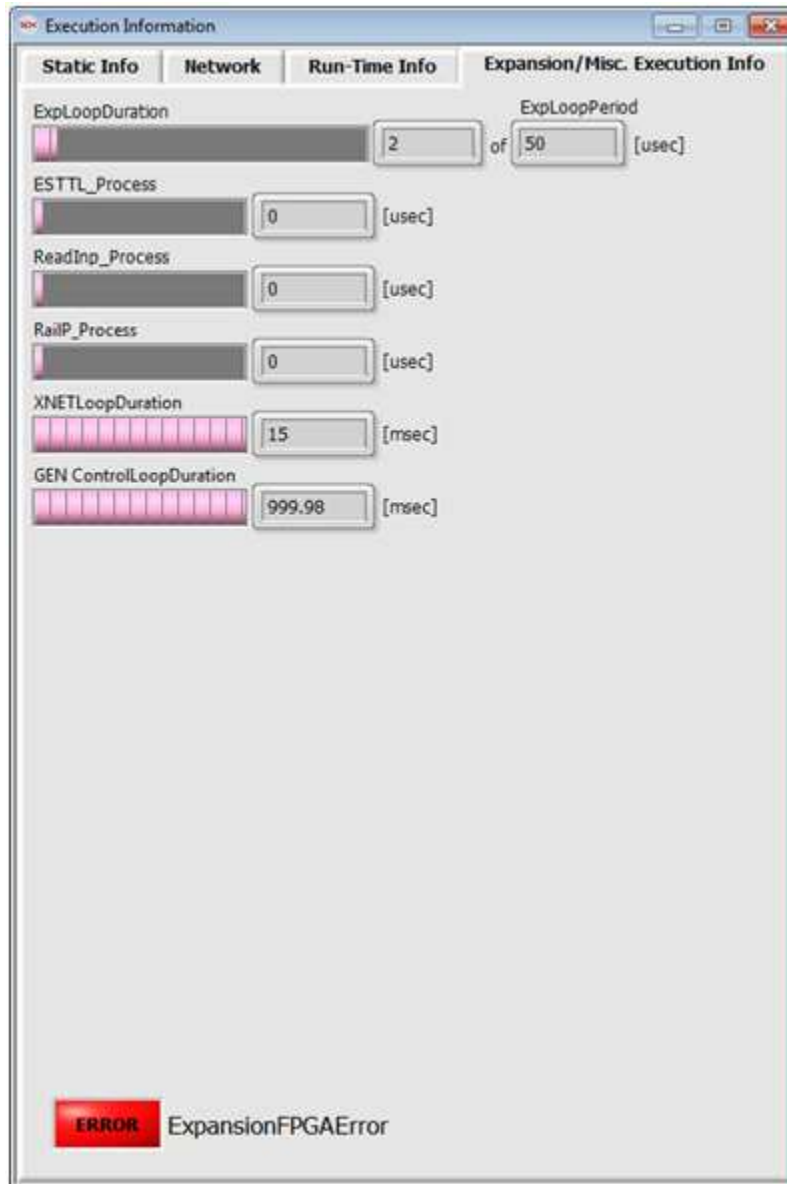

5. Troubleshooting

A Windows Help file (.chm) for the DI Driver System is provided on the cRIO controller along with the DI Driver System software image. The help file is downloaded from the controller to the computer along with the user interface windows when making the initial system connection. Each window within the user interface contains a Help "?" button in the bottom right corner. Pressing this button will open the Help file to the associated help topic page.

Frequently Asked Questions (FAQs)

Q: I powered the DI Driver System controller and the USER1 and USER FPGA LEDs are not both blinking after 1 minute. What do I do?

A: Is the USER1 LED blinking 3 times followed by a long steady ON? If so, there is an activation error. Please contact the National Instruments support team.

If the USER1 and USER FPGA LEDs are not blinking at all, please try pressing and immediately releasing the controller reset button. Wait 1 minute for the LEDs to start blinking. If they do not start blinking, refer to the section [Restoring A Backup Image To The DI Driver System Controller](#). If a system backup image is not available, please contact the National Instruments support team.

Verify power supply voltage and current specifications.

Q: I cannot connect to the DI Driver System user interface via SCM and I do not know the system controller IP address. What do I do?

A: Refer to the section [Manually Resetting The Controller Network Interface to DHCP](#) to troubleshoot and establish a network connection to the controller. If a connection still cannot be established, please contact the National Instruments support team or visit www.ni.com/getting-started/.

Q: I got the following error message on the XNET CAN Setup Window upon enabling the CAN_Run button: "NI-XNET: (Hex 0xBFF63020) An invalid reference has been passed to a NI-XNET session function. Solution: Only pass reference retrieved from Create Session, or from an IO name of a session in LabVIEW project." What do I do?

A: Follow these debugging steps:

- a) Verify that the XNET module is appropriately powered on the Vsup pin (pin 9) and COM pin (either pin 3 or 6).
- b) Disable the CAN_Run button. Ensure that the CAN Interface and deployed databases, clusters and ECUs all show up on the XNET CAN Setup Window. Click the Refresh Database button and ensure that the appropriate database, cluster(s) and ECU(s) are selected. Click the CAN_Run button again. If the error still persists, follow step c)
- c) Download and install NI-RIO 14.0: <http://www.ni.com/download/ni-rio-14.0.1/4862/en/>. This should install NI MAX (Measurement and Automation Explorer) if you don't already have it installed. Open up NI MAX, then under remote systems, find your controller and expand the tree. Under Devices and Interfaces, you should see NI 9862 "CAN1". There should be a warning mark next to it which indicates a compatibility issue between the XNET CAN module and the controller. Click on the NI 9862 "CAN1" device and push Update Firmware on the right window and click OK. You don't have to stop the user interface or the application that is running on the controller while the firmware is updating. Click the CAN_Run button again on the XNET CAN Setup Window. If the error still persists, please contact the National Instruments support team.

6. Diagrams

1. Reverse Battery Relay Protection Diagram

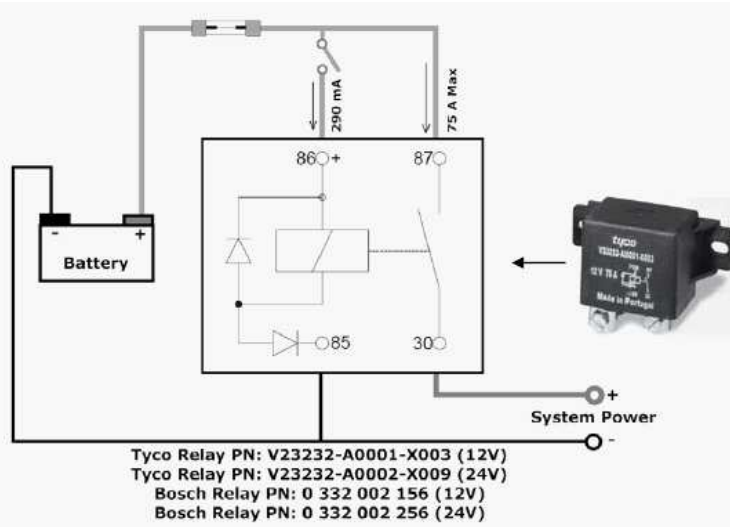

2. NI cRIO-9082 Slot Assignments

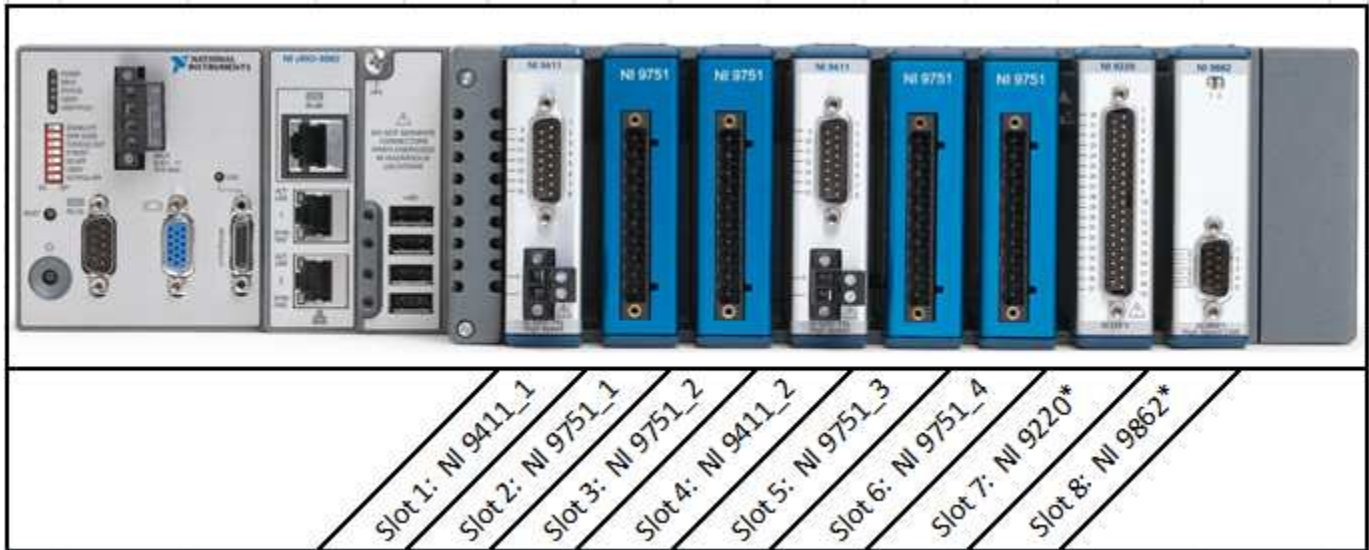

3. NI 9155 MXIe Express RIO Chassis Slot Assignments

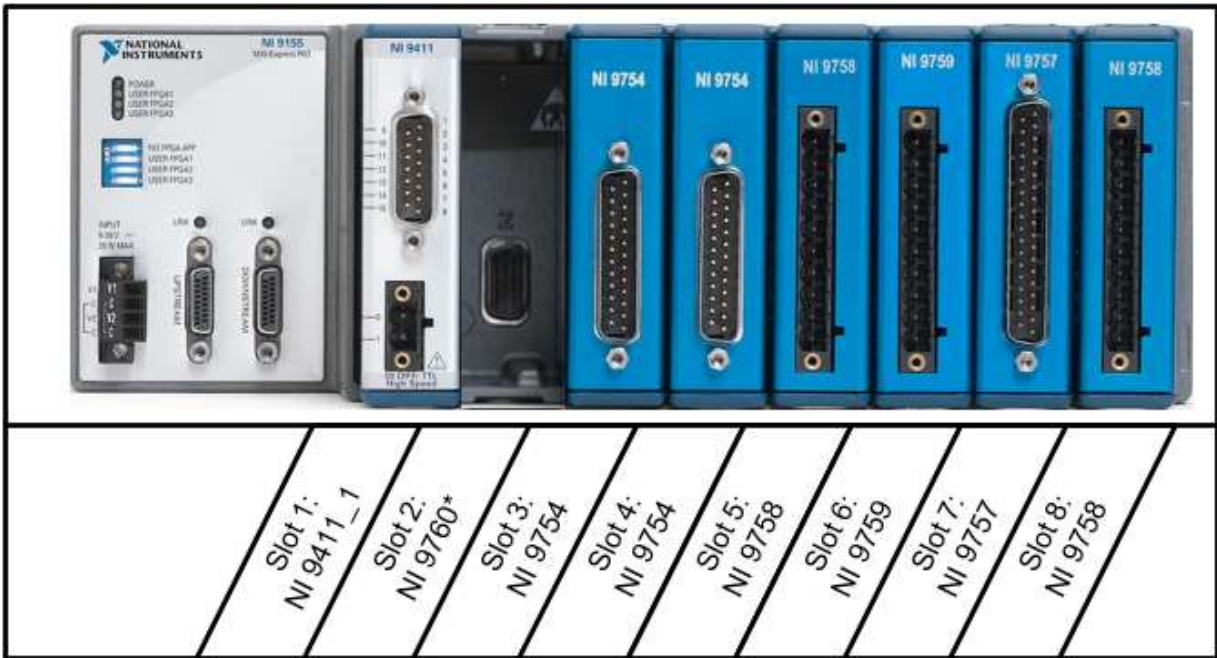

* Slot 2 is Reserved for future support modules

4. NI cRIO-9082 Front Panel

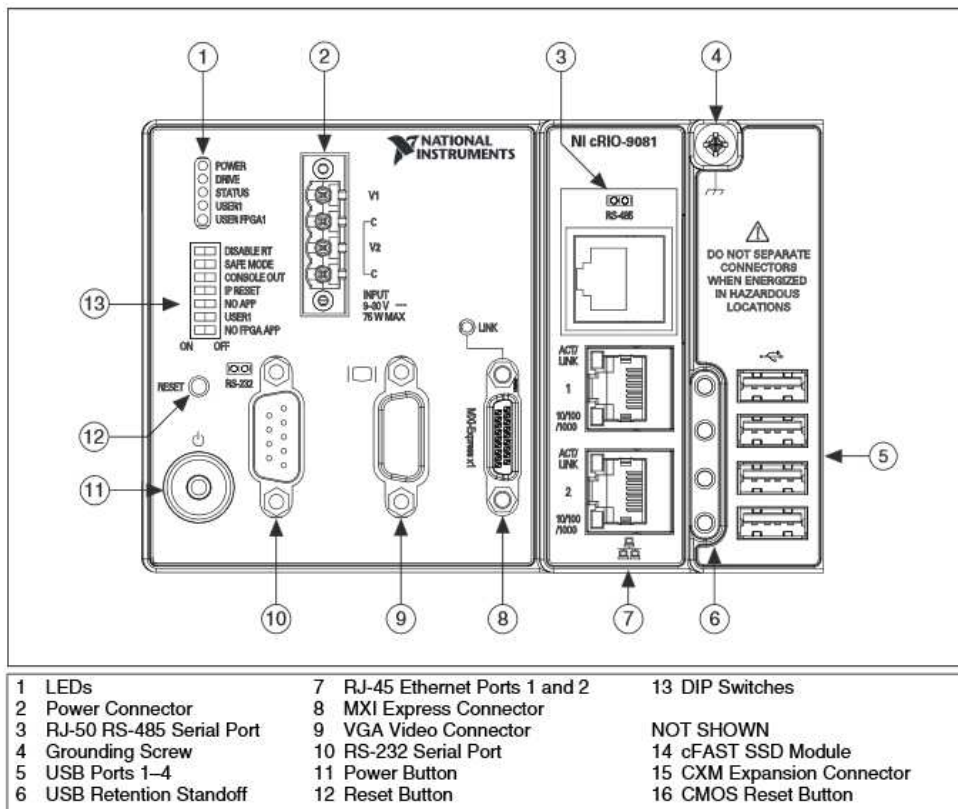

5. COMBICON power connector for NI cRIO-9082

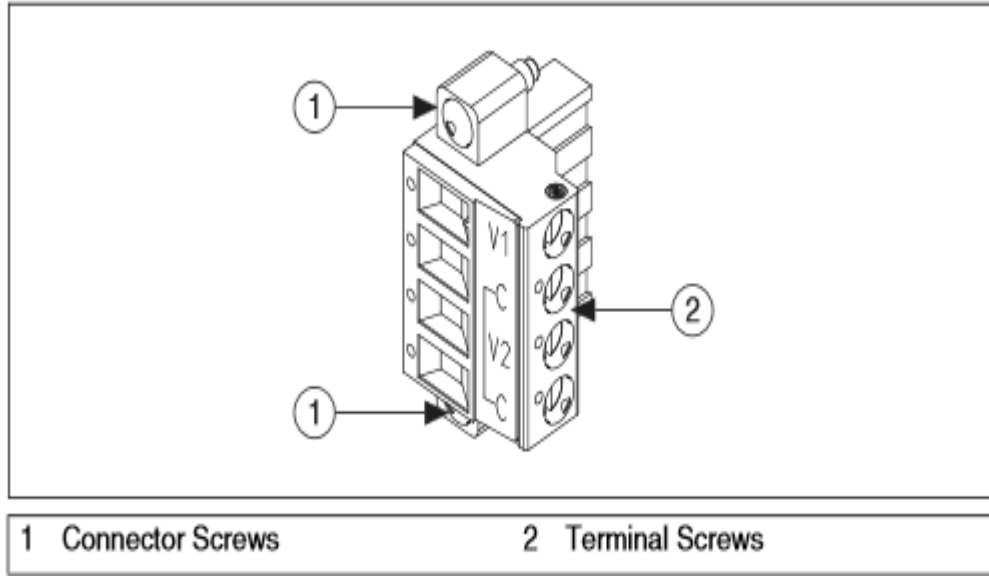

6. NI 9155 MXIe Express RIO Front Panel

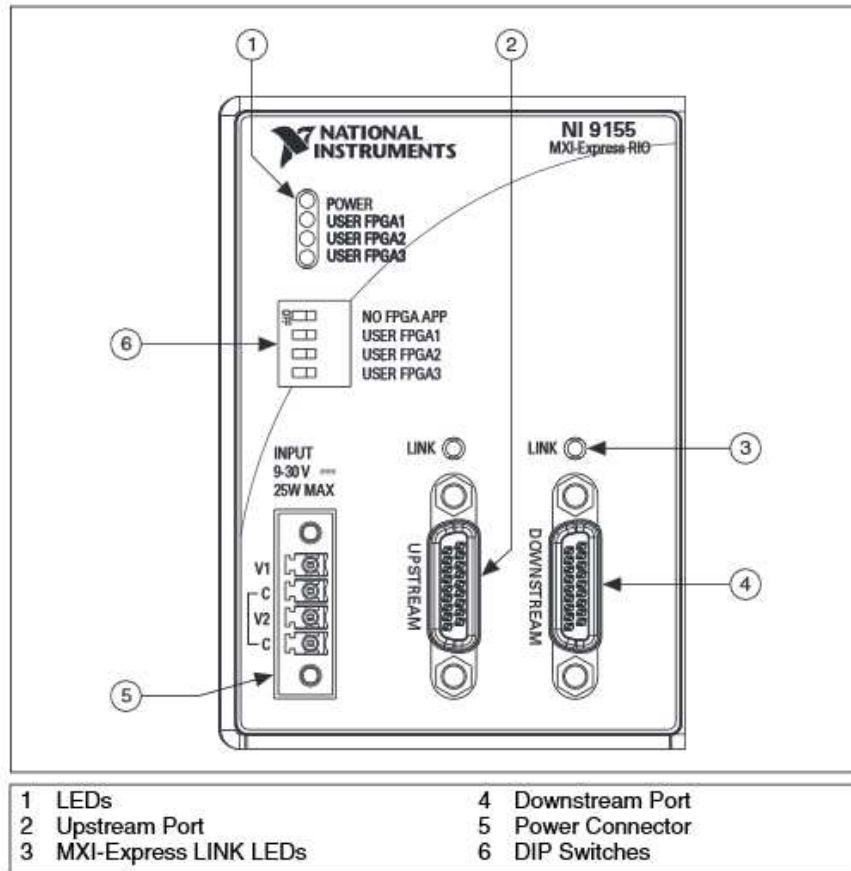

7. COMBICON power connector for NI 9155 MXIe Express RIO Chassis

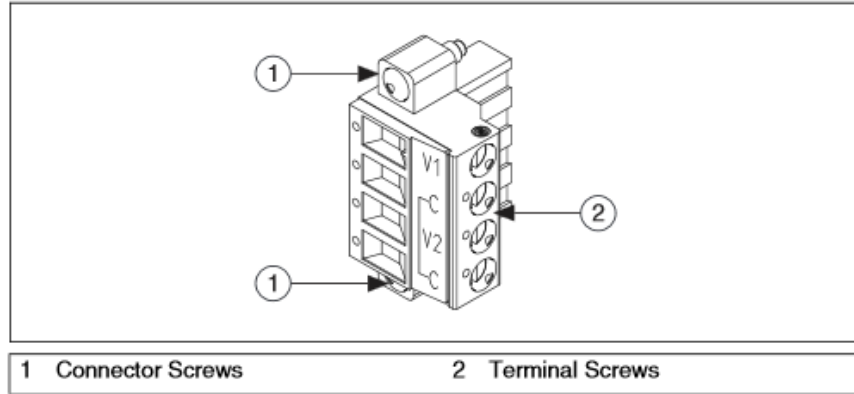

8. NI 9411 Digital Input Module Terminal Assignments

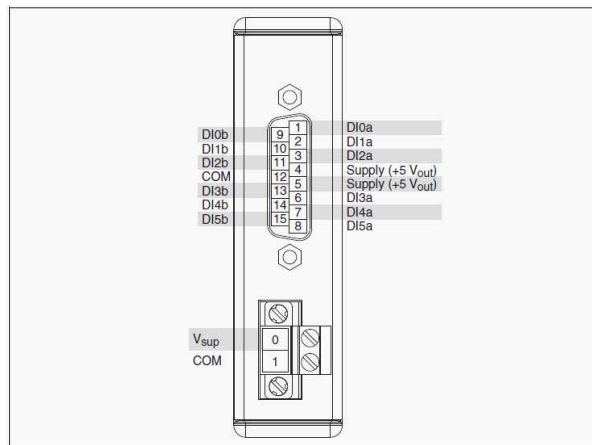

9. NI 9751 DI Driver Terminal assignments

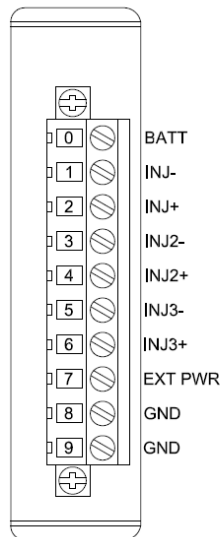

10. NI 9220 Analog Input Module Terminal assignments

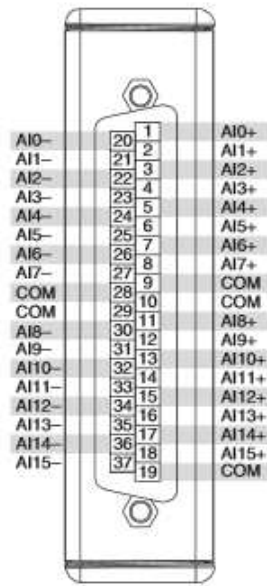

11. NI 9862 1-Port CAN Module Terminal Assignments

Connector	Pin	Signal
	1	No Connection (NC)
	2	CAN_L
	3	COM
	4	NC
	5	SHLD
	6	COM
	7	CAN_H
	8	NC
	9	V _{SUP}

12. NI-9754 ESTTL Output Module Terminal Assignments

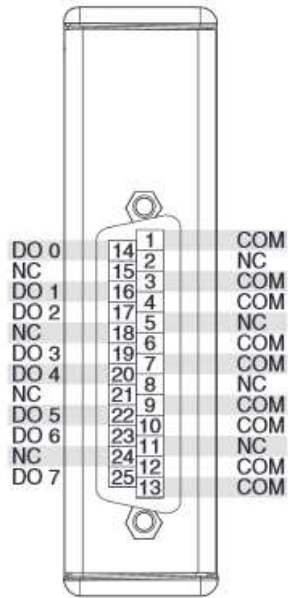

13. NI-9757 O2 Sensor Module Terminal Assignments

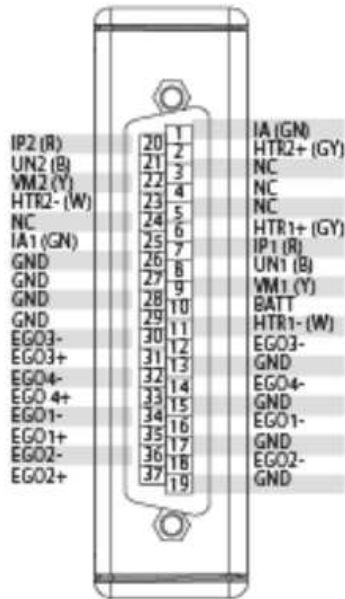

14. NI 9758 PFI Driver Module Terminal assignments

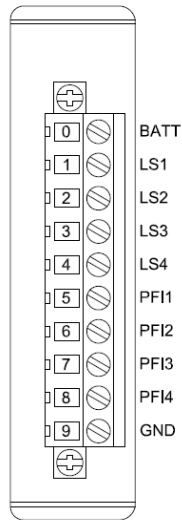

15. NI 9759 Electronic Throttle Driver Module Terminal Assignments

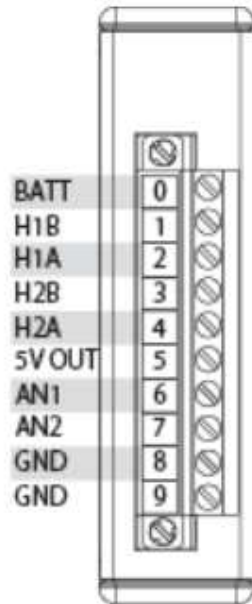

16. Use of Ferrules on Screw Terminal Connections

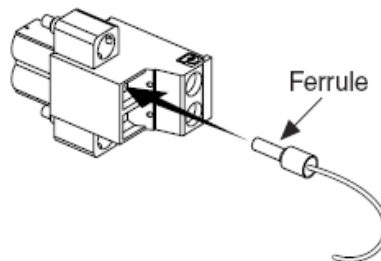

17. Connecting Solenoid Direct Injectors to the DI Driver

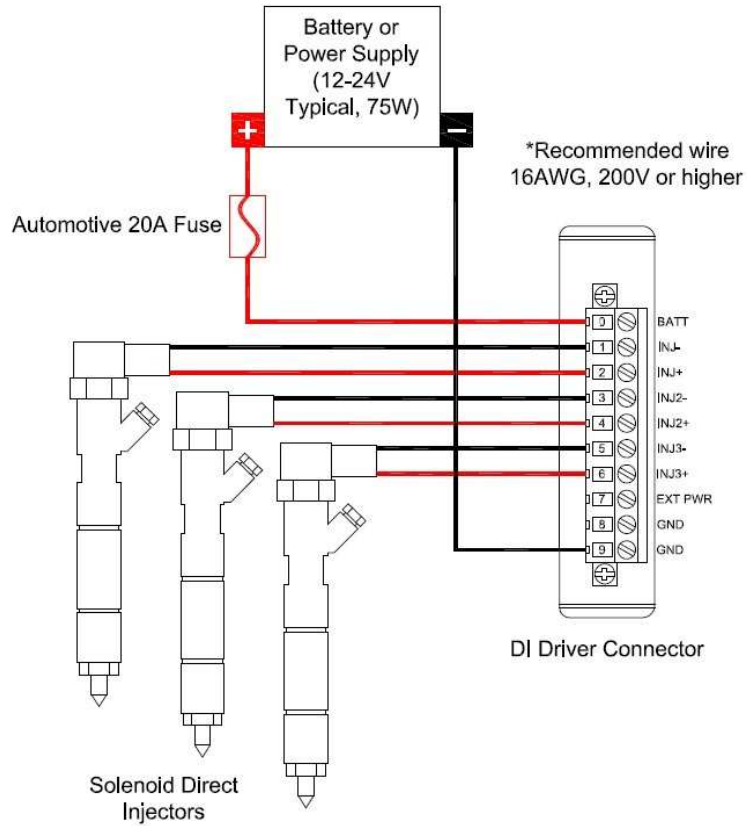

18. Connecting Piezo Direct Injectors to the DI Driver

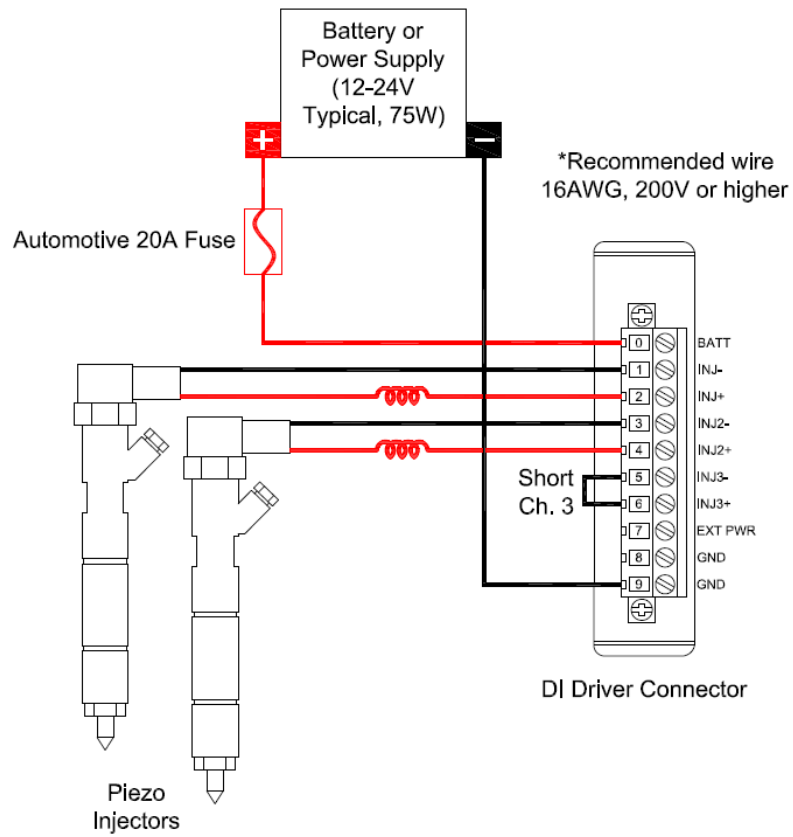

19. Connecting Port Fuel Injectors to the PFI Driver

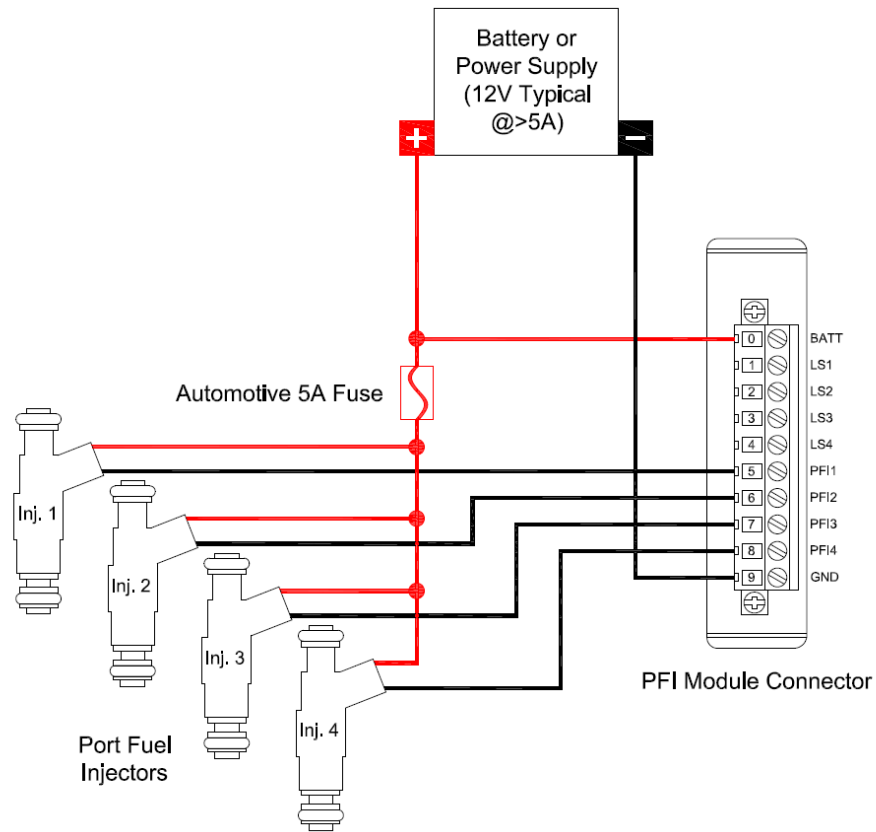

20. Connecting General Purpose Solenoids to the PFI Driver LS Channels

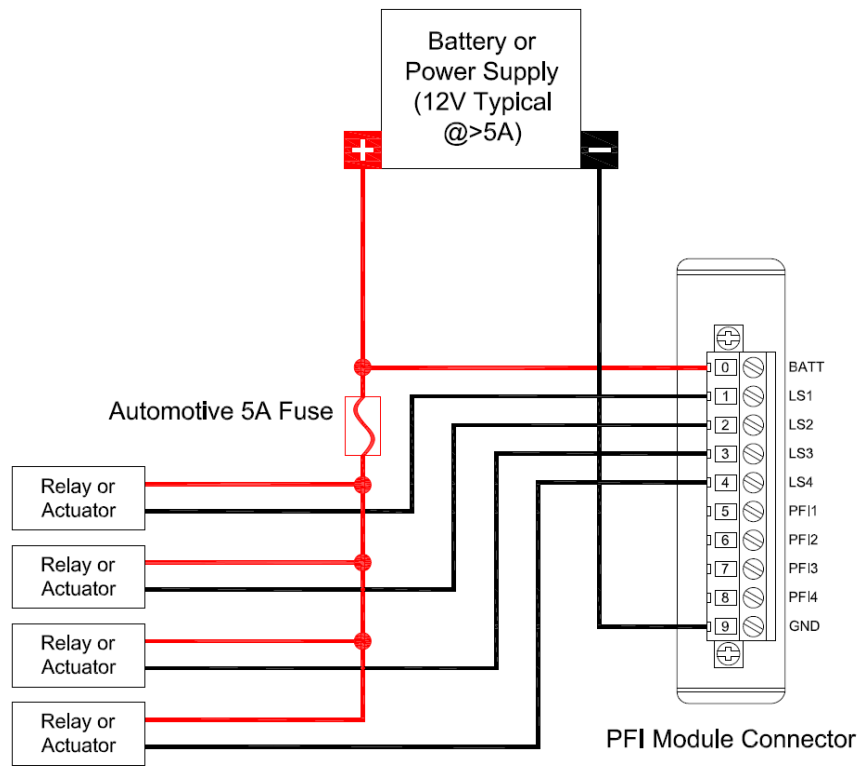

21. Connecting Inlet Metering/High Pressure Valves to the PFI Driver

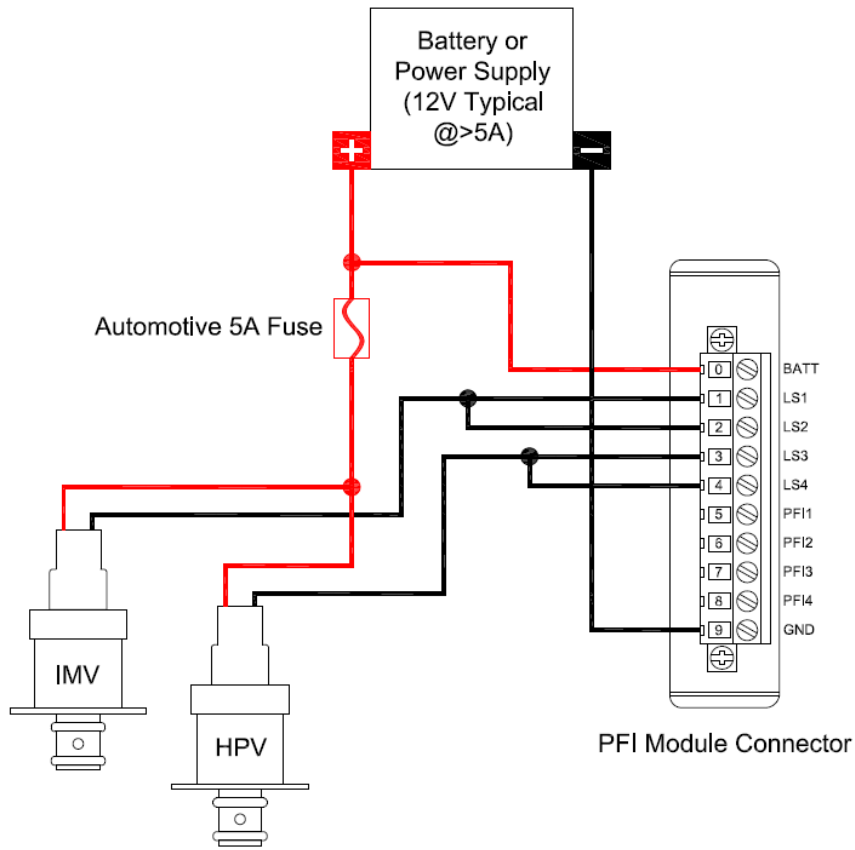

22. TDK to cRIO Remote Connection

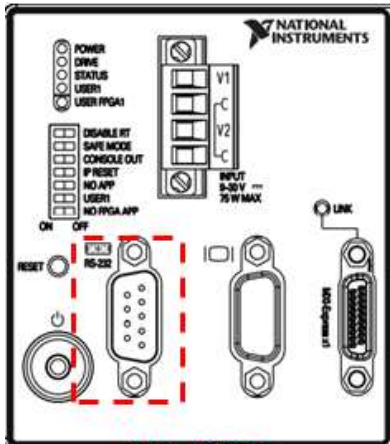

**cRIO 9082
RS232 serial
connector**

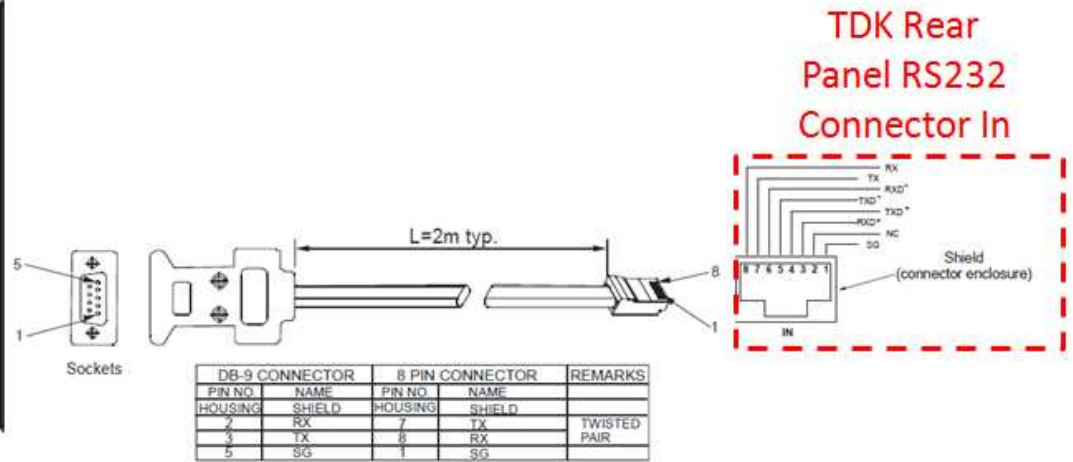

Fig.7-3: RS232 cable with DB9 connector (P/N: GEN/232-9)

7. Additional Support/Feedback

Please contact NI Systems Support at 1-210-248-9308 or powertraincontrolsinfo@ni.com.

8. Important Information

8.1 Warranty

Remove the following paragraph for software products.

The EXPANDABLE DIRECT INJECTOR DRIVER SYSTEM is warranted against defects in materials and workmanship for a period of one year from the date of shipment, as evidenced by receipts or other documentation. National Instruments will, at its option, repair or replace equipment that proves to be defective during the warranty period. This warranty includes parts and labor.

The media on which you receive National Instruments software are warranted not to fail to execute programming instructions, due to defects in materials and workmanship, for a period of 90 days from date of shipment, as evidenced by receipts or other documentation. National Instruments will, at its option, repair or replace software media that do not execute programming instructions if National Instruments receives notice of such defects during the warranty period. National Instruments does not warrant that the operation of the software shall be uninterrupted or error free.

A Return Material Authorization (RMA) number must be obtained from the factory and clearly marked on the outside of the package before any equipment will be accepted for warranty work. National Instruments will pay the shipping costs of returning to the owner parts which are covered by warranty.

National Instruments believes that the information in this document is accurate. The document has been carefully reviewed for technical accuracy. In the event that technical or typographical errors exist, National Instruments reserves the right to make changes to subsequent editions of this document without prior notice to holders of this edition. The reader should consult National Instruments if errors are suspected. In no event shall National Instruments be liable for any damages arising out of or related to this document or the information contained in it.

EXCEPT AS SPECIFIED HEREIN, NATIONAL INSTRUMENTS MAKES NO WARRANTIES, EXPRESS OR IMPLIED, AND SPECIFICALLY DISCLAIMS ANY WARRANTY OF MERCHANTABILITY OR FITNESS FOR A PARTICULAR PURPOSE. CUSTOMER'S RIGHT TO RECOVER DAMAGES CAUSED BY FAULT OR NEGLIGENCE ON THE PART OF NATIONAL INSTRUMENTS SHALL BE LIMITED TO THE AMOUNT THEREFORE PAID BY THE CUSTOMER. NATIONAL INSTRUMENTS WILL NOT BE LIABLE FOR DAMAGES RESULTING FROM LOSS OF DATA, PROFITS, USE OF PRODUCTS, OR INCIDENTAL OR CONSEQUENTIAL DAMAGES, EVEN IF ADVISED OF THE POSSIBILITY THEREOF. This limitation of the liability of National Instruments will apply regardless of the form of action, whether in contract or tort, including negligence. Any action against National Instruments must be brought within one year after the cause of action accrues. National Instruments shall not be liable for any delay in performance due to causes beyond its reasonable control. The warranty provided herein does not cover damages, defects, malfunctions, or service failures caused by owner's failure to follow the National Instruments installation, operation, or maintenance instructions; owner's modification of the product; owner's abuse, misuse, or negligent acts; and power failure or surges, fire, flood, accident, actions of third parties, or other events outside reasonable control.

8.2 Copyright

Under the copyright laws, this publication may not be reproduced or transmitted in any form, electronic or mechanical, including photocopying, recording, storing in an information retrieval system, or translating, in whole or in part, without the prior written consent of National Instruments Corporation.

National Instruments respects the intellectual property of others, and we ask our users to do the same. NI software is protected by copyright and other intellectual property laws. Where NI software may be used to reproduce software or other materials belonging to others, you may use NI software only to reproduce materials that you may reproduce in accordance with the terms of any applicable license or other legal restriction.

End-User License Agreements and Third-Party Legal Notices

You can find end-user license agreements (EULAs) and third-party legal notices in the following locations:

Notices are located in the <National Instruments>_Legal Information and <National Instruments> directories.

EULAs are located in the <National Instruments>\Shared\MDF\Legal\license directory.

Review <National Instruments>_Legal Information.txt for information on including legal information in installers built with NI products.

8.3 Trademarks

Refer to the NI Trademarks and Logo Guidelines at ni.com/trademarks for more information on National Instruments trademarks.

ARM, Keil, and μ Vision are trademarks or registered of ARM Ltd or its subsidiaries.

LEGO, the LEGO logo, WEDO, and MINDSTORMS are trademarks of the LEGO Group. ©2013 The LEGO Group.

TETRIX by Pitsco is a trademark of Pitsco, Inc. ©2013.

FIELDBUS FOUNDATION™ and FOUNDATION™ are trademarks of the Fieldbus Foundation.

EtherCAT® is a registered trademark of and licensed by Beckhoff Automation GmbH.

CANopen® is a registered Community Trademark of CAN in Automation e.V.

DeviceNet™ and EtherNet/IP™ are trademarks of ODVA.

Go!, SensorDAQ, and Vernier are registered trademarks of Vernier Software & Technology. Vernier Software & Technology and vernier.com are trademarks or trade dress.

Xilinx is the registered trademark of Xilinx, Inc.

Taptite and Trilobular are registered trademarks of Research Engineering & Manufacturing Inc.

FireWire® is the registered trademark of Apple Inc.

Linux® is the registered trademark of Linus Torvalds in the U.S. and other countries.

Handle Graphics®, MATLAB®, Real-Time Workshop®, Simulink®, Stateflow®, and xPC TargetBox® are registered trademarks, and TargetBox™ and Target Language Compiler™ are trademarks of The MathWorks, Inc.

Tektronix®, Tek, and Tektronix, Enabling Technology are registered trademarks of Tektronix, Inc.

The Bluetooth® word mark is a registered trademark owned by the Bluetooth SIG, Inc.

The ExpressCard™ word mark and logos are owned by PCMCIA and any use of such marks by National Instruments is under license.

The mark LabWindows is used under a license from Microsoft Corporation. Windows is a registered trademark of Microsoft Corporation in the United States and other countries.

Other product and company names mentioned herein are trademarks or trade names of their respective companies.

Members of the National Instruments Alliance Partner Program are business entities independent from National Instruments and have no agency, partnership, or joint-venture relationship with National Instruments.

8.4 Patents

For patents covering the National Instruments products/technology, refer to the appropriate location: Help»Patents in your software, the patents.txt file on your media, or the National Instruments Patent Notice at ni.com/patents.

8.5 Warning Regarding Use of NI Products

WARNING REGARDING USE OF NATIONAL INSTRUMENTS PRODUCTS

(1) NATIONAL INSTRUMENTS PRODUCTS ARE NOT DESIGNED WITH COMPONENTS AND TESTING FOR A LEVEL OF RELIABILITY SUITABLE FOR USE IN OR IN CONNECTION WITH SURGICAL IMPLANTS OR AS CRITICAL COMPONENTS IN ANY LIFE SUPPORT SYSTEMS WHOSE FAILURE TO PERFORM CAN REASONABLY BE EXPECTED TO CAUSE SIGNIFICANT INJURY TO A HUMAN.

(2) IN ANY APPLICATION, INCLUDING THE ABOVE, RELIABILITY OF OPERATION OF THE SOFTWARE PRODUCTS CAN BE IMPAIRED BY ADVERSE FACTORS, INCLUDING BUT NOT LIMITED TO FLUCTUATIONS IN ELECTRICAL POWER SUPPLY, COMPUTER HARDWARE MALFUNCTIONS, COMPUTER OPERATING SYSTEM SOFTWARE FITNESS, FITNESS OF COMPILERS AND DEVELOPMENT SOFTWARE USED TO DEVELOP AN APPLICATION, INSTALLATION ERRORS, SOFTWARE AND HARDWARE COMPATIBILITY PROBLEMS, MALFUNCTIONS OR FAILURES OF ELECTRONIC MONITORING OR CONTROL DEVICES, TRANSIENT FAILURES OF ELECTRONIC SYSTEMS (HARDWARE AND/OR SOFTWARE), UNANTICIPATED USES OR MISUSES, OR ERRORS ON THE PART OF THE USER OR APPLICATIONS DESIGNER (ADVERSE FACTORS SUCH AS THESE ARE HEREAFTER COLLECTIVELY TERMED "SYSTEM FAILURES"). ANY APPLICATION WHERE A SYSTEM FAILURE WOULD CREATE A RISK OF HARM TO PROPERTY OR PERSONS (INCLUDING THE RISK OF BODILY INJURY AND DEATH) SHOULD NOT BE RELIANT SOLELY UPON ONE FORM OF ELECTRONIC SYSTEM DUE TO THE RISK OF SYSTEM FAILURE. TO AVOID DAMAGE, INJURY, OR DEATH, THE USER OR APPLICATION DESIGNER MUST TAKE REASONABLY PRUDENT STEPS TO PROTECT AGAINST SYSTEM FAILURES, INCLUDING BUT NOT LIMITED TO BACK-UP OR SHUT DOWN MECHANISMS. BECAUSE EACH END-USER SYSTEM IS CUSTOMIZED AND DIFFERS FROM NATIONAL INSTRUMENTS' TESTING PLATFORMS AND BECAUSE A USER OR APPLICATION DESIGNER MAY USE NATIONAL INSTRUMENTS PRODUCTS IN COMBINATION WITH OTHER PRODUCTS IN A MANNER NOT EVALUATED OR CONTEMPLATED BY NATIONAL INSTRUMENTS, THE USER OR APPLICATION DESIGNER IS ULTIMATELY RESPONSIBLE FOR VERIFYING AND VALIDATING THE SUITABILITY OF NATIONAL INSTRUMENTS PRODUCTS WHENEVER NATIONAL INSTRUMENTS PRODUCTS ARE INCORPORATED IN A SYSTEM OR APPLICATION, INCLUDING, WITHOUT LIMITATION, THE APPROPRIATE DESIGN, PROCESS AND SAFETY LEVEL OF SUCH SYSTEM OR APPLICATION.

8.6 Environmental Management

National Instruments is committed to designing and manufacturing products in an environmentally responsible manner. NI recognizes that eliminating certain hazardous substances from our products is beneficial not only to the environment but also to NI customers.

For additional environmental information, refer to the NI and the Environment Web page at ni.com/environment. This page contains the environmental regulations and directives with which NI complies, as well as other environmental information not included in this document.