

## COMPREHENSIVE SERVICES

We offer competitive repair and calibration services, as well as easily accessible documentation and free downloadable resources.

## SELL YOUR SURPLUS

We buy new, used, decommissioned, and surplus parts from every NI series. We work out the best solution to suit your individual needs.

 Sell For Cash    Get Credit    Receive a Trade-In Deal

## OBSOLETE NI HARDWARE IN STOCK & READY TO SHIP

We stock **New**, **New Surplus**, **Refurbished**, and **Reconditioned** NI Hardware.



*Bridging the gap between the manufacturer and your legacy test system.*

 1-800-915-6216

 [www.apexwaves.com](http://www.apexwaves.com)

 [sales@apexwaves.com](mailto:sales@apexwaves.com)

*All trademarks, brands, and brand names are the property of their respective owners.*

**Request a Quote**

 **CLICK HERE**

**NI-9871**

# SPECIFICATIONS AND FEATURES GUIDE

# NI Serial Hardware

This document lists safety and compliance information for NI Serial hardware, as well as physical specifications, software features, and recommended operating conditions.

## Contents

---

|   |    |
|---|----|
| NI-Serial Supported Interfaces .....      | 2  |
| Serial Hardware Features .....            | 6  |
| USB LED Descriptions .....                | 7  |
| Connectors and Pinouts .....              | 8  |
| DB-9 Male .....                           | 8  |
| 10-Position Modular Jack (10P10C) .....   | 9  |
| 68-Pin Connector .....                    | 10 |
| Cables and Accessories .....              | 12 |
| RS-232, RS-422, and RS-485 .....          | 13 |
| RS-232, RS-422, and RS-485 Features ..... | 13 |
| RS-232 Loopback .....                     | 14 |
| RS-232 Signals .....                      | 14 |
| RS-485/422 Loopback .....                 | 14 |
| RS-485/422 Signals .....                  | 15 |
| RS-485 Topologies .....                   | 15 |
| RS-485 Transceiver Control .....          | 16 |
| UART Data Frame Example .....             | 16 |
| Hardware Specifications .....             | 17 |
| NI 9870 RS-232 C-Series Module .....      | 17 |
| NI 9871 RS-485 C-Series Module .....      | 20 |
| PCI Serial Hardware .....                 | 22 |
| PCI Express Serial Hardware .....         | 28 |
| PXI Serial Hardware .....                 | 33 |
| PXI Express Serial Hardware .....         | 39 |
| USB Serial Hardware .....                 | 44 |
| ExpressCard Serial Hardware .....         | 47 |

# NI-Serial Supported Interfaces

The PCI interfaces listed in Table 1 are universal cards which accept either 3.3 or 5 volts.

**Table 1.** PCI Interfaces

| PCI Interfaces | Standard          | # Ports | Isolated | Max Baud (kbaud)* | Connector Type† | FIFO Size (Bytes) |
|----------------|-------------------|---------|----------|-------------------|-----------------|-------------------|
| PCI-8430/2     | RS-232            | 2       | No       | 1000.0            | DB-9 male       | 128               |
| PCI-8430/4     | RS-232            | 4       | No       | 1000.0            | 10P10C          | 128               |
| PCI-8430/8     | RS-232            | 8       | No       | 1000.0            | 68-pin SCSI     | 128               |
| PCI-8430/16    | RS-232            | 16      | No       | 1000.0            | 68-pin VHDCI    | 128               |
| PCI-8431/2     | RS-485/<br>RS-422 | 2       | No       | 3000.0‡           | DB-9 male       | 128               |
| PCI-8431/4     | RS-485/<br>RS-422 | 4       | No       | 3000.0‡           | 10P10C          | 128               |
| PCI-8431/8     | RS-485/<br>RS-422 | 8       | No       | 3000.0‡           | 68-pin SCSI     | 128               |
| PCI-8432/2     | RS-232            | 2       | Yes      | 1000.0            | DB-9 male       | 128               |
| PCI-8432/4     | RS-232            | 4       | Yes      | 1000.0            | 10P10C          | 128               |
| PCI-8433/2     | RS-485/<br>RS-422 | 2       | Yes      | 3000.0‡           | DB-9 male       | 128               |
| PCI-8433/4     | RS-485/<br>RS-422 | 4       | Yes      | 3000.0‡           | 10P10C          | 128               |

\* All NI serial hardware supports standard baud rates. In addition, the PCI/NI PCIe/PXI-843x family of hardware supports any baud rate from 2 baud up to the maximum supported baud rate for that interface. All baud rates are supported because the UART can get within 1.3 percent of all baud rates in that range.

† Serial connector cables end in DB-9 male serial connectors.

‡ The two-wire auto control mode for RS-485 transceiver control has a maximum baud rate of 2000 kbaud.

**Table 2. PCI Express Interfaces**

| PCI Express Interfaces | Standard          | # Ports | Isolated | Max Baud (kbaud)* | Connector Type† | FIFO Size (Bytes) |
|------------------------|-------------------|---------|----------|-------------------|-----------------|-------------------|
| NI PCIe-8430/8         | RS-232            | 8       | No       | 1000.0            | 68-pin VHDCI    | 128               |
| NI PCIe-8430/16        | RS-232            | 16      | No       | 1000.0            | 68-pin VHDCI    | 128               |
| NI PCIe-8431/8         | RS-485/<br>RS-422 | 8       | No       | 3000.0‡           | 68-pin VHDCI    | 128               |
| NI PCIe-8431/16        | RS-485/<br>RS-422 | 16      | No       | 3000.0‡           | 68-pin VHDCI    | 128               |

\* All NI serial hardware supports standard baud rates. In addition, the PCI/NI PCIe/PXI-843x family of hardware supports any baud rate from 2 baud up to the maximum supported baud rate for that interface. All baud rates are supported because the UART can get within 1.3 percent of all baud rates in that range.

† Serial connector cables end in DB-9 male serial connectors.

‡ The two-wire auto control mode for RS-485 transceiver control has a maximum baud rate of 2000 kbaud.

**Table 3. PXI Interfaces**

| PXI Interfaces | Standard          | # Ports | Isolated | Max Baud (kbaud)* | Connector Type† | FIFO Size (Bytes) |
|----------------|-------------------|---------|----------|-------------------|-----------------|-------------------|
| PXI-8430/2     | RS-232            | 2       | No       | 1000.0            | DB-9 male       | 128               |
| PXI-8430/4     | RS-232            | 4       | No       | 1000.0            | 10P10C          | 128               |
| PXI-8430/8     | RS-232            | 8       | No       | 1000.0            | 68-pin SCSI     | 128               |
| PXI-8430/16    | RS-232            | 16      | No       | 1000.0            | 68-pin VHDCI    | 128               |
| PXI-8431/2     | RS-485/<br>RS-422 | 2       | No       | 3000.0‡           | DB-9 male       | 128               |
| PXI-8431/4     | RS-485/<br>RS-422 | 4       | No       | 3000.0‡           | 10P10C          | 128               |
| PXI-8431/8     | RS-485/<br>RS-422 | 8       | No       | 3000.0‡           | 68-pin SCSI     | 128               |
| PXI-8432/2     | RS-232            | 2       | Yes      | 1000.0            | DB-9 male       | 128               |
| PXI-8432/4     | RS-232            | 4       | Yes      | 1000.0            | 10P10C          | 128               |

**Table 3. PXI Interfaces (Continued)**

| PXI Interfaces | Standard          | # Ports | Isolated | Max Baud (kbaud)* | Connector Type† | FIFO Size (Bytes) |
|----------------|-------------------|---------|----------|-------------------|-----------------|-------------------|
| PXI-8433/2     | RS-485/<br>RS-422 | 2       | Yes      | 3000.0‡           | DB-9 male       | 128               |
| PXI-8433/4     | RS-485/<br>RS-422 | 4       | Yes      | 3000.0‡           | 10P10C          | 128               |

\* All NI serial hardware supports standard baud rates. In addition, the PCI/NI PCIe/PXI-843x family of hardware supports any baud rate from 2 baud up to the maximum supported baud rate for that interface. All baud rates are supported because the UART can get within 1.3 percent of all baud rates in that range.

† Serial connector cables end in DB-9 male serial connectors.

‡ The two-wire auto control mode for RS-485 transceiver control has a maximum baud rate of 2000 kbaud.

**Table 4. PXI Express Interfaces**

| PXI Express Interfaces | Standard          | # Ports | Isolated | Max Baud (kbaud)* | Connector Type† | FIFO Size (Bytes) |
|------------------------|-------------------|---------|----------|-------------------|-----------------|-------------------|
| NI PXIe-8430/8         | RS-232            | 8       | No       | 1000.0            | 68-pin<br>VHDCI | 128               |
| NI PXIe-8430/16        | RS-232            | 16      | No       | 1000.0            | 68-pin<br>VHDCI | 128               |
| NI PXIe-8431/8         | RS-485/<br>RS-422 | 8       | No       | 3000.0‡, **       | 68-pin<br>VHDCI | 128               |
| NI PXIe-8431/16        | RS-485/<br>RS-422 | 16      | No       | 3000.0‡, **       | 68-pin<br>VHDCI | 128               |

\* All NI serial hardware supports standard baud rates. In addition, the PXI/NI PXIe-843x family of hardware supports any baud rate from 2 baud up to the maximum supported baud rate for that interface. All baud rates are supported because the UART can get within 1.3 percent of all baud rates in that range.

† Serial connector cables end in DB-9 male serial connectors.

‡ The two-wire auto control mode for RS-485 transceiver control has a maximum baud rate of 2000 kbaud.

\*\* For possible use with higher baud rates, refer to [ni.com/kb](http://ni.com/kb) and search for KnowledgeBase **58KEI82F**.

**Table 5. USB Interfaces**

| <b>USB Interfaces</b> | <b>Standard</b>   | <b># Ports</b> | <b>Isolated</b> | <b>Max Baud (kbaud)*</b> | <b>Connector Type</b> | <b>FIFO Size (Bytes)</b> |
|-----------------------|-------------------|----------------|-----------------|--------------------------|-----------------------|--------------------------|
| USB-232               | RS-232            | 1              | No              | 230.4                    | DB-9 male             | 128                      |
| USB-232/2             | RS-232            | 2              | No              | 230.4                    | DB-9 male             | 128                      |
| USB-232/4             | RS-232            | 4              | No              | 230.4                    | DB-9 male             | 128                      |
| USB-485               | RS-485/<br>RS-422 | 1              | No              | 460.8                    | DB-9 male             | 128                      |
| USB-485/2             | RS-485/<br>RS-422 | 2              | No              | 460.8                    | DB-9 male             | 128                      |
| USB-485/4             | RS-485/<br>RS-422 | 4              | No              | 460.8                    | DB-9 male             | 128                      |

\* All NI serial hardware supports standard baud rates. In addition, the PCI/NI PCIe/PXI-843x family of hardware supports any baud rate from 2 baud up to the maximum supported baud rate for that interface. All baud rates are supported because the UART can get within 1.3 percent of all baud rates in that range.

**Table 6. ExpressCard Interfaces**

| <b>ExpressCard Interfaces</b> | <b>Standard</b>   | <b># Ports</b> | <b>Isolated</b> | <b>Max Baud (kbaud)*</b> | <b>Connector Type</b> | <b>FIFO Size (Bytes)</b> |
|-------------------------------|-------------------|----------------|-----------------|--------------------------|-----------------------|--------------------------|
| NI ExpressCard-8420/2         | RS-232            | 2              | No              | 230.4                    | DB-9 male             | 128                      |
| NI ExpressCard-8421/2         | RS-485/<br>RS-422 | 2              | No              | 460.8                    | DB-9 male             | 128                      |

\* All NI serial hardware supports standard baud rates. In addition, the PCI/NI PCIe/PXI-843x family of hardware supports any baud rate from 2 baud up to the maximum supported baud rate for that interface. All baud rates are supported because the UART can get within 1.3 percent of all baud rates in that range.

National Instruments considers the following baud rates to be standard. NI serial hardware supports these rates up to the maximum rate specified. Your device may also support additional baud rates not listed below:

|      |      |       |        |        |
|------|------|-------|--------|--------|
| 300  | 2400 | 14400 | 57600  | 460800 |
| 600  | 4800 | 19200 | 115200 |        |
| 1200 | 9600 | 38400 | 230400 |        |

To set the baud rate, set the VISA Baud attribute or use the Windows SetCommState function and pass the actual value of the baud rate in the **BaudRate** field of the **DCB** structure.

Refer to [Hardware Specifications](#) for supported baud rates on each board.

# Serial Hardware Features

To determine which features your product supports, refer to the following table.

**Table 7.** Serial Hardware Features

| Hardware  | Adjustable FIFO Settings | Get Interface Type | RS-485 Transceiver Control | RS-485 Socketed Bias Resistors | RS-485 Programmatically Controlled Bias Resistors | RS-232 Transceiver State | RS-232 DTE/DCE Transceiver Control | Hardware Implemented Flow Control |         |          |
|---|--------------------------|--------------------|----------------------------|--------------------------------|---|--------------------------|------------------------------------|-----------------------------------|---------|----------|
|   |                          |                    |                            |                                |   |                          |                                    | RTS/CTS                           | DTR/DSR | Xon/Xoff |
| PCI/NI PCIe/PXI/<br>NIPXIe-8430,<br>PCI/PXI-8432  | ✓                        | ✓                  |                            |                                |   | ✓                        |                                    | ✓                                 | ✓       | ✓        |
| PCI/NI PCIe/PXI/<br>NI PXIe-8431<br>eight port and<br>NI PXIe/<br>NI PCIe-8431<br>16 port | ✓                        | ✓                  | ✓                          |                                |   |                          |                                    | ✓                                 |         | ✓        |
| All other<br>PCI/PXI-8431<br>and<br>PCI/PXI-8433  | ✓                        | ✓                  | ✓                          | ✓                              |   |                          |                                    | ✓                                 |         | ✓        |
| USB-232 one port  |                          | ✓                  |                            |                                |   | ✓                        |                                    | ✓                                 | ✓       | ✓        |
| USB-232 two and<br>four port  |                          | ✓                  |                            |                                |   | ✓                        | ✓                                  | ✓                                 | ✓       | ✓        |
| USB-485 one port  |                          | ✓                  | ✓                          |                                | ✓   |                          |                                    | ✓                                 |         | ✓        |

**Table 7. Serial Hardware Features (Continued)**

| Hardware                  | Adjustable FIFO Settings | Get Interface Type | RS-485 Transceiver Control | RS-485 Socketed Bias Resistors | RS-485 Programmatically Controlled Bias Resistors | RS-232 Transceiver State | RS-232 DTE/DCE Transceiver Control | Hardware Implemented Flow Control |         |          |
|---------------------------|--------------------------|--------------------|----------------------------|--------------------------------|---|--------------------------|------------------------------------|-----------------------------------|---------|----------|
|                           |                          |                    |                            |                                |   |                          |                                    | RTS/CTS                           | DTR/DSR | Xon/Xoff |
| USB-485 two and four port |                          | ✓                  | ✓                          | ✓                              | ✓   |                          |                                    | ✓                                 |         | ✓        |
| NI ExpressCard -8420      |                          | ✓                  |                            |                                |   | ✓                        |                                    | ✓                                 | ✓       | ✓        |
| NI ExpressCard -8421      |                          | ✓                  | ✓                          |                                | ✓   |                          |                                    | ✓                                 |         | ✓        |



# USB LED Descriptions

The USB serial two and four-port hardware uses bicolor LEDs to indicate device and port status. Table 8 describes these LEDs; Figure 1 shows their location.

**Table 8.** USB LEDs

| LED    | Description  |
|--------|--|
| Ready  | <p><b>Dim Red</b>—Powered, but not connected to USB (self-powered USB only)</p> <p><b>Red</b>—Powered and connected to USB, but not fully configured</p> <p><b>Yellow</b>—Device is ready (normal operation)</p> <p><b>Blinking Red or Red-Yellow</b>—Device error. Contact NI.</p>  |
| Port x | <p><b>Solid Red</b>—Port is open, but no valid signals detected (USB-232 only)</p> <p><b>Solid Green</b>—Port is open</p> <p><b>Blinking Yellow</b>—Port is transmitting</p> <p><b>Blinking Green</b>—Port is receiving</p> <p><b>Alternated Blinking Green/Yellow</b>—Port is transmitting and receiving</p> <p><b>Blinking Red</b>—Port error (framing error, FIFO overrun, or parity error)</p> |

**Figure 1.** USB-Serial Hardware LEDs

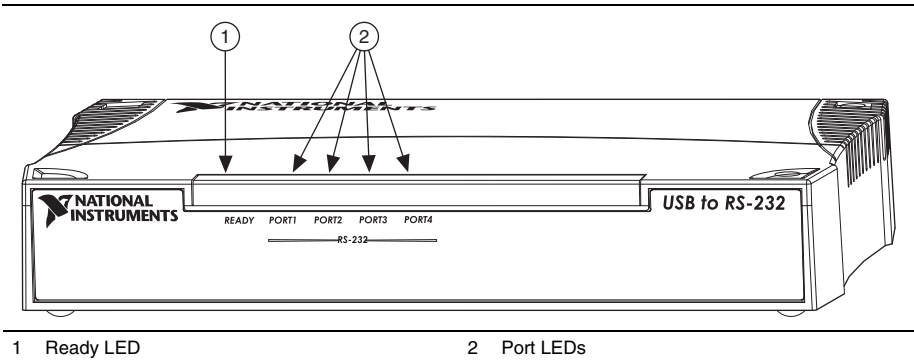

1 Ready LED

2 Port LEDs

## Connectors and Pinouts

### DB-9 Male

**Figure 2.** DB-9 Connector Pin Locations

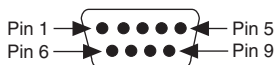

**Table 9. DB-9 Male Pin Descriptions**

| Pin | 232 DTE | 232 DCE | 422/485     |
|-----|---------|---------|-------------|
| 1   | DCD*    | DCD     | GND         |
| 2   | RXD     | TXD     | CTS+ (HSI+) |
| 3   | TXD     | RXD     | RTS+ (HSO+) |
| 4   | DTR*    | DSR     | RXD+        |
| 5   | GND     | GND     | RXD-        |
| 6   | DSR*    | DTR     | CTS- (HSI-) |
| 7   | RTS     | CTS     | RTS- (HSO-) |
| 8   | CTS     | RTS     | TXD+        |
| 9   | RI*     | RI      | TXD-        |

\* These signals are “No Connect” on the PCI-232I and PXI-8422 ports and ports 9-16 on legacy 16-port boards.



**Note** DCE mode supported on USB-232/2 and USB-232/4 only.

## 10-Position Modular Jack (10P10C)

**Figure 3. 10-Position Modular Jack Pin Locations**

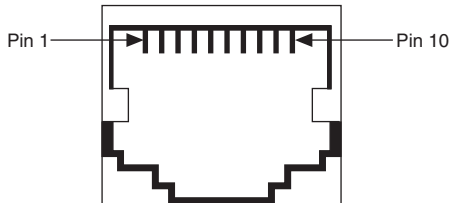

**Table 10. 10-Position Modular Jack Pin Descriptions**

| Pin | 232        | 422/485     |
|-----|------------|-------------|
| 1   | No Connect | No Connect  |
| 2   | RI*        | TXD-        |
| 3   | CTS        | TXD+        |
| 4   | RTS        | RTS- (HSO-) |
| 5   | DSR*       | CTS- (HSI-) |

**Table 10.** 10-Position Modular Jack Pin Descriptions (Continued)

| Pin | 232  | 422/485     |
|-----|------|-------------|
| 6   | GND  | RXD-        |
| 7   | DTR* | RXD+        |
| 8   | TXD  | RTS+ (HSO+) |
| 9   | RXD  | CTS+ (HSI+) |
| 10  | DCD* | GND         |

\* These signals are “No Connect” on the PCI-232I and PXI-8422 ports.

## 68-Pin Connector

The following figures and table give the 68-pin connector pin locations and descriptions. The SCSI 68-pin connector and VHDCI 68-pin connector have the same pinout.

**Figure 4.** 68-Pin SCSI Connector Pin Locations

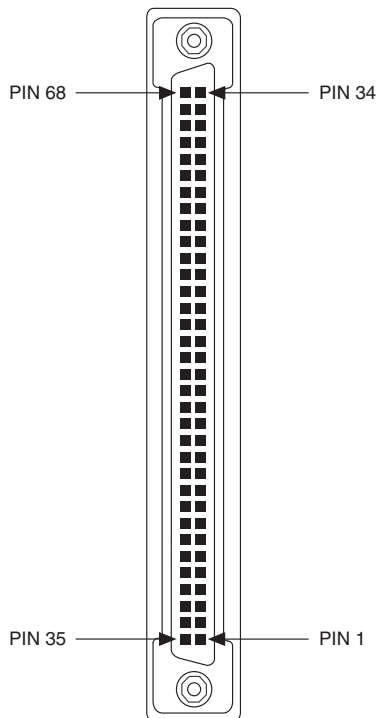

**Figure 5.** 68-Pin VHDCI Connector Pin Locations

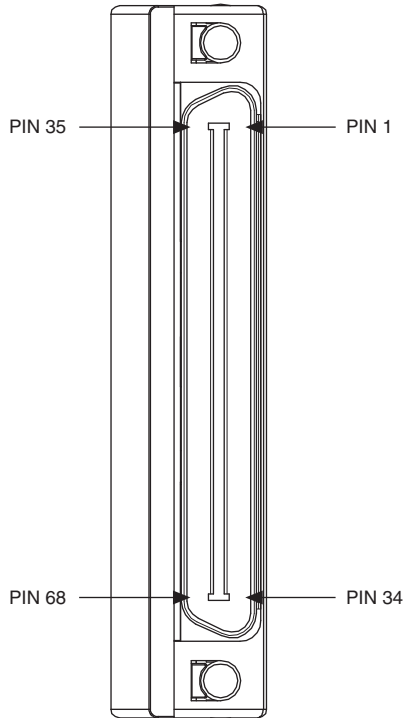

**Table 11.** 68-Pin Connector Pin Descriptions

| 68-Pin Connector Port |    |    |    |    |    |    |   | 485 Signal | 485 D-Sub 9 Connector | 232 Signal | 232 D-Sub 9 Connector |
|-----------------------|----|----|----|----|----|----|---|------------|-----------------------|------------|-----------------------|
| 1                     | 2  | 3  | 4  | 5  | 6  | 7  | 8 |            |                       |            |                       |
| 66                    | 57 | 49 | 40 | 32 | 23 | 15 | 6 | RXD-       | 5                     | DCD        | 1                     |
| 68                    | 59 | 51 | 42 | 34 | 25 | 17 | 8 | CTS+       | 2                     | RXD        | 2                     |
| 65                    | 56 | 48 | 39 | 31 | 22 | 14 | 5 | RTS+       | 3                     | TXD        | 3                     |
| 64                    | 55 | 47 | 38 | 30 | 21 | 13 | 4 | RXD+       | 4                     | DTR        | 4                     |
| 60                    | 60 | 43 | 43 | 26 | 26 | 9  | 9 | GND        | 1                     | GND        | 5                     |
| 63                    | 54 | 46 | 37 | 29 | 20 | 12 | 3 | CTS-       | 6                     | DSR        | 6                     |
| 62                    | 53 | 45 | 36 | 28 | 19 | 11 | 2 | RTS-       | 7                     | RTS        | 7                     |
| 61                    | 52 | 44 | 35 | 27 | 18 | 10 | 1 | TXD+       | 8                     | CTS        | 8                     |
| 67                    | 58 | 50 | 41 | 33 | 24 | 16 | 7 | TXD-       | 9                     | RI         | 9                     |

## Cables and Accessories

The following serial cables and accessories are available from National Instruments. Refer to [ni.com](http://ni.com) for more information.

**Table 12.** Serial Cables and Accessories

| Part Number  | Description   |
|--|---|
| <b>Adapter Cables</b> (DB-9 and DB-25 connectors have jacksockets unless otherwise specified.) |   |
| 182844-01  | DB-9 RS485 terminating pass-through connector 120 $\Omega$      |
| 182845-01  | Serial cable, 10P10C modular plug to DB-9 male, 1 m             |
| 182845-02  | Serial cable, 10P10C modular plug to DB-9 male, 2 m             |
| 182845-03  | Serial cable, 10P10C modular plug to DB-9 male, 3 m             |
| 182846-01  | Serial cable, 10P10C modular plug to DB-25 male, 1 m            |
| 184428-01  | Serial cable, 10P10C modular plug to DB-9 male, 1 m, isolated   |
| 199022-02  | Serial cable, 10P10C to DB-9 male, jackscrews, 2 m              |
| 197545-01  | Serial cable, 68-pin VHDCI to eight DB-9 male, RS-232, 1 m      |
| 197546-01  | Serial cable, 68-pin VHDCI to eight DB-9 male, RS-485, 1 m      |
| <b>Extension and Null-Modem Cables</b> (All cables have jackscrews.)                           |   |
| 182238-01  | Serial cable, RS232 null modem, DB-9 female to DB-9 female, 1 m |
| 182238-02  | Serial cable, RS232 null modem, DB-9 female to DB-9 female, 2 m |

**Table 12.** Serial Cables and Accessories (Continued)

| <b>Part Number</b> | <b>Description</b>  |
|--------------------|---|
| 182238-04          | Serial cable, RS232 null modem, DB-9 female to DB-9 female, 4 m       |
| 183045-01          | Serial cable, RS232 straight through, DB-9 female to DB-9 female, 1 m |
| 183045-02          | Serial cable, RS232 straight through, DB-9 female to DB-9 female, 2 m |
| 183045-04          | Serial cable, RS232 straight through, DB-9 female to DB-9 female, 4 m |
| 183283-01          | Serial cable, RS485/RS422 null modem, DB-9 female to DB-9 female, 1 m |
| 183283-02          | Serial cable, RS485/RS422 null modem, DB-9 female to DB-9 female, 2 m |
| 183283-04          | Serial cable, RS485/RS422 null modem, DB-9 female to DB-9 female, 4 m |

## RS-232, RS-422, and RS-485

### RS-232, RS-422, and RS-485 Features

**Table 13.** RS-232, RS-422, and RS-485 Features

| <b>Feature</b>  | <b>RS-232</b>     | <b>RS-422</b> | <b>RS-485</b> |
|---|-------------------|---------------|---------------|
| Type of transmission lines  | Single ended      | Differential  | Differential  |
| Maximum number of drivers   | 1                 | 1             | 32            |
| Maximum number of receivers                                       | 1                 | 10            | 32            |
| Maximum cable length  | 2.5 nF equivalent | 4,000 ft      | 4,000 ft      |
| Maximum CMV   | ±25 V             | ±7 V          | +12 to -7 V   |
| Driver output*  | 5 to 25 V         | 2 to 6 V      | 1.5 to 6 V    |
| Driver load   | <3 kΩ             | 100 Ω         | 60 Ω          |
| * Actual driver output varies depending on cable length and load. |                   |               |               |

# RS-232 Loopback

**Figure 6.** RS-232 Loopback

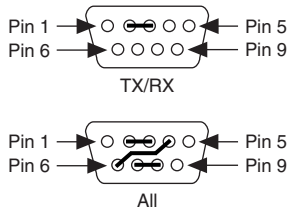

# RS-232 Signals

**Figure 7.** RS-232 Signals

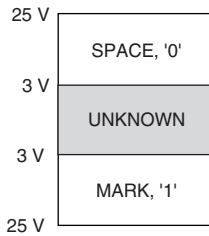

# RS-485/422 Loopback

**Figure 8.** RS-485/422 Loopback

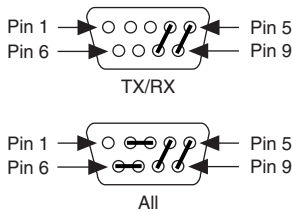

# RS-485/422 Signals

**Figure 9.** RS-485/422 Signals

|                                 |
|---------------------------------|
| If " < '+'<br>then MARK, '1'    |
| If " > '+'<br>then SPACE, '0'   |
| RS-422 Voltage: 7 V             |
| RS-485 Voltage:<br>7 V to +12 V |

## RS-485 Topologies

**Figure 10.** 2-Wire Multidrop Network Using Terminating Resistors

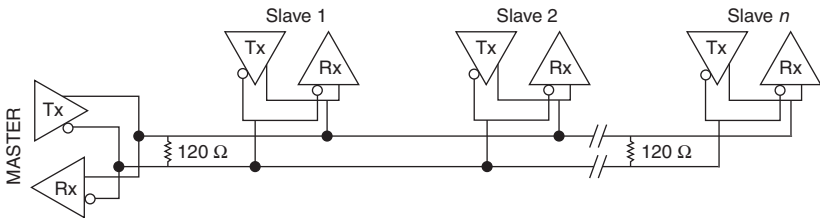

**Figure 11.** 4-Wire Full-Duplex Multidrop Network Using Terminating Resistors

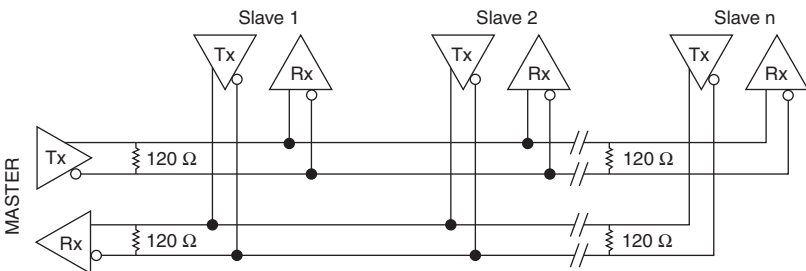

The driver directly supports 4-wire full-duplex operation on peer-to-peer RS-485 networks. Multidrop RS-485 networks require additional software development.

RS-485 terminators are available at [ni.com/serial](http://ni.com/serial).



# RS-485 Transceiver Control

**Table 14.** RS-485 Transceiver Control

| Enable | 4-Wire | 2-Wire   |             |      |
|--------|--------|----------|-------------|------|
|        |        | DTR/Echo | DTR/No Echo | Auto |
| TX     | ON     | DTR      | DTR         | TX   |
| RX     | ON     | ON       | DTR         | TX   |

The available modes might vary with the controller or interface used. For further information refer to [ni.com/kb](http://ni.com/kb) and search for KnowledgeBase **67KEP64G**.

## UART Data Frame Example

0xD9—8 Data Bits, Odd Parity, 1 Stop Bit

**Figure 12.** UART Data Frame Example

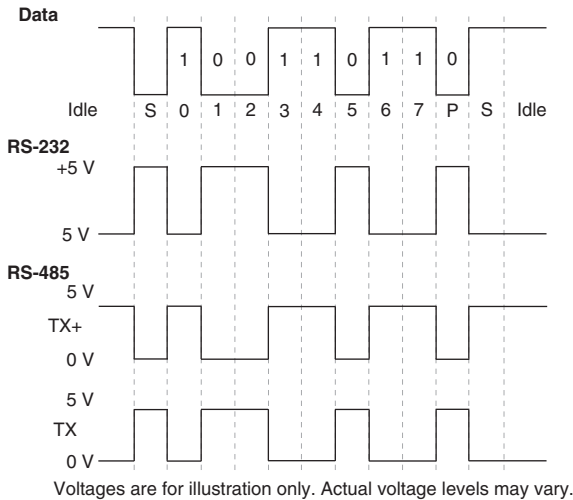

# Hardware Specifications

---

## NI 9870 RS-232 C-Series Module

C-Series modules are for use with the NI CompactRIO platform. For complete module and system specifications, refer to the *NI 9870 Operating Instructions and Specifications*.

### Specifications

The following specifications are typical for the range -40 to 70 °C unless otherwise noted.

Maximum baud rate..... 921.6 kbps

The NI 9870 supports arbitrary baud rates according to the following equation:

$$\text{BaudRate} = 3.6864 \text{ Mbps} / (\text{Prescaler} * \text{Divider})$$

*Prescaler* can be (4..65535).

*Divider* can be 1 or 4.

As long as the actual baud rate is within 2% of the desired baud rate, communication errors should not happen.

Maximum cable length..... 250 pF equivalent



**Note** Cable capacitance greater than 250 pF may adversely affect the maximum baud rate and thermal dissipation.

Maximum RS232 Receive signal  
(RXD, CTS, DSR, DCD, RI)

Continuous Voltage..... ±8 V



**Note** Continuous RS232 input voltages in excess of ±8 V may cause excessive thermal dissipation.

Data line ESD protection

(human body model)..... ±15 kV

MTBF ..... 448,008 hours at 25 °C; Bellcore Issue 6,  
Method 1, Case 3, Limited Part Stress Method



**Note** Contact NI for Bellcore MTBF specifications at other temperatures or for MIL-HDBK-217F specifications.

### Power Requirements

Power consumption from chassis

Active mode..... 0.5 W max

Sleep mode ..... 50 μW max

## Thermal dissipation (at 70 °C)

|                   |           |
|-------------------|-----------|
| Active mode ..... | 1.5 W max |
| Sleep mode .....  | 0.5 W max |

## Required external supply

voltage range ( $V_{SUP}$ ) ..... +8 to +28 VDC

## Power supply consumption from external supply $V_{SUP}$

|              |       |
|--------------|-------|
| Typical..... | 0.5 W |
| Maximum..... | 2 W   |

## Physical Characteristics

If you need to clean the module, wipe it with a dry towel.

Weight ..... Approx. 154 g (5.4 oz)

## Safety

### Maximum Voltage<sup>1</sup>

Connect only voltages that are within these limits.

#### RS232 Receive Signal-to-COM

(RXD, CTS, DSR, DCD, RI)..... ±25 V max,  
Measurement Category I

#### RS232 Transmit Signal-to-COM

(TX, RTS, DTR) ..... ±13.2 V max,  
Measurement Category I

$V_{SUP}$ -to-COM..... ±28 V max,  
Measurement Category I

Measurement Category I is for measurements performed on circuits not directly connected to the electrical distribution system referred to as *MAINS* voltage. MAINS is a hazardous live electrical supply system that powers equipment. This category is for measurements of voltages from specially protected secondary circuits. Such voltage measurements include signal levels, special equipment, limited-energy parts of equipment, circuits powered by regulated low-voltage sources, and electronics.



**Caution** Do *not* connect to signals or use for measurements within Measurement Categories II, III, or IV.

---

<sup>1</sup> The maximum voltage that can be applied or output without creating a safety hazard.

## Isolation Voltages

### Port-to-earth ground

|                  |   |
|------------------|---|
| Withstand .....  | 1000 V <sub>rms</sub> , verified by a 5 s dielectric withstand test |
| Continuous ..... | 60 VDC,<br>Measurement Category I                                   |

## Shock and Vibration

To meet these specifications, you must panel mount the CompactRIO system.

### Operating vibration,

random (IEC 60068-2-64) ..... 5 g<sub>rms</sub>, 10 to 500 Hz

Operating shock (IEC 60068-2-27) ..... 30 g, 11 ms half sine,  
50 g, 3 ms half sine,  
18 shocks at 6 orientations

### Operating vibration,

sinusoidal (IEC 60068-2-6) ..... 5 g, 10 to 500 Hz

## Environmental

CompactRIO modules are intended for indoor use only. For outdoor use, mount the CompactRIO system in a suitably rated enclosure. Refer to the installation instructions for the chassis you are using for more information about meeting these specifications.

Operating temperature ..... -40 to 70 °C

Storage temperature ..... -40 to 85 °C

Ingress protection ..... IP 40

Operating humidity ..... 10 to 90% RH, noncondensing

Storage humidity ..... 5 to 95% RH, noncondensing

Maximum altitude ..... 2,000 m

Pollution Degree (IEC 60664) ..... 2

# NI 9871 RS-485 C-Series Module

C-Series modules are for use with the NI CompactRIO platform. For complete module and system specifications, refer to the *NI 9871 Operating Instructions and Specifications*.

## Specifications

The following specifications are typical for the range -40 to 70 °C unless otherwise noted.

Maximum baud rate ..... 3.6864 Mbps

The NI 9871 supports arbitrary baud rates according to the following equation:

$$\text{BaudRate} = 3.6864 \text{ Mbps} / (\text{Prescaler} * \text{Divider})$$

*Prescaler* can be (4..65535).

*Divider* can be 1 or 4.

As long as the actual baud rate is within 2% of the desired baud rate, communication errors should not happen.

Maximum cable length ..... 1.2 km (4,000 ft)

Data line ESD protection  
(human body model)..... ±15 kV

MTBF..... 514,016 hours at 25 °C; Bellcore Issue 6,  
Method 1, Case 3, Limited Part Stress Method



**Note** Contact NI for Bellcore MTBF specifications at other temperatures or for MIL-HDBK-217F specifications.

## Power Requirements

Power consumption from chassis

Active mode ..... 0.5 W max  
Sleep mode..... 50 µW max

Thermal dissipation (at 70 °C)

Active mode ..... 1.5 W max  
Sleep mode..... 55 mW max

Required external supply

voltage range ( $V_{SUP}$ ) ..... +8 to +28 VDC

Power supply consumption from external supply  $V_{SUP}$

Typical..... 1 W  
Maximum..... 3.5 W

# Physical Characteristics

If you need to clean the module, wipe it with a dry towel.

Weight..... Approx. 153 g (5.4 oz)

## Safety

### Maximum Voltage<sup>1</sup>

Connect only voltages that are within these limits.

RS485/RS422 Port-to-COM.....-8 to +13 VDC max,  
Measurement Category I

V<sub>SUP</sub>-to-COM .....±28 V max,  
Measurement Category I

Measurement Category I is for measurements performed on circuits not directly connected to the electrical distribution system referred to as *MAINS* voltage. MAINS is a hazardous live electrical supply system that powers equipment. This category is for measurements of voltages from specially protected secondary circuits. Such voltage measurements include signal levels, special equipment, limited-energy parts of equipment, circuits powered by regulated low-voltage sources, and electronics.



**Caution** Do *not* connect to signals or use for measurements within Measurement Categories II, III, or IV.

## Isolation Voltages

Port-to-earth ground

Withstand..... 1000 V<sub>rms</sub>, verified by a 5 s dielectric  
withstand test

Continuous..... 60 VDC,  
Measurement Category I

## Shock and Vibration

To meet these specifications, you must panel mount the CompactRIO system.

Operating vibration,  
random (IEC 60068-2-64)..... 5 g<sub>rms</sub>, 10 to 500 Hz

Operating shock (IEC 60068-2-27)..... 30 g, 11 ms half sine,  
50 g, 3 ms half sine,  
18 shocks at 6 orientations

Operating vibration,  
sinusoidal (IEC 60068-2-6)..... 5 g, 10 to 500 Hz

<sup>1</sup> The maximum voltage that can be applied or output without creating a safety hazard.

## Environmental

CompactRIO modules are intended for indoor use only. For outdoor use, mount the CompactRIO system in a suitably rated enclosure. Refer to the installation instructions for the chassis you are using for more information about meeting these specifications.

|                                    |                             |
|------------------------------------|-----------------------------|
| Operating temperature .....        | -40 to 70 °C                |
| Storage temperature .....          | -40 to 85 °C                |
| Ingress protection.....            | IP 40                       |
| Operating humidity .....           | 10 to 90% RH, noncondensing |
| Storage humidity .....             | 5 to 95% RH, noncondensing  |
| Maximum altitude.....              | 2,000 m                     |
| Pollution Degree (IEC 60664) ..... | 2                           |

## PCI Serial Hardware

This section describes the characteristics of the PCI serial hardware and the recommended operating conditions.

### PCI-843x Series Hardware

#### PCI-8430/2 (RS-232) and PCI-8431/2 (RS-485/422)

|                                      |                                     |
|--------------------------------------|-------------------------------------|
| Dimensions .....                     | 10.67 × 14.22 cm<br>(4.2 × 5.6 in.) |
| I/O connector .....                  | DB-9 male connector                 |
| Power requirement (from PCI channel) |                                     |
| PCI-8430/2                           |                                     |
| +5 VDC.....                          | 325 mA typical<br>500 mA maximum    |
| PCI-8431/2                           |                                     |
| +5 VDC.....                          | 500 mA typical<br>700 mA maximum    |

#### Weight

|                 |      |
|-----------------|------|
| PCI-8430/2..... | 88 g |
| PCI-8431/2..... | 92 g |

#### Maximum baud rate

|                 |        |
|-----------------|--------|
| PCI-8430/2..... | 1 Mbps |
| PCI-8431/2..... | 3 Mbps |

Boards support any baud rate from 2 baud up to the maximum.

## PCI-8430/4 (RS-232) and PCI-8431/4 (RS-485/422)

Dimensions ..... 10.67 × 14.22 cm  
(4.2 × 5.6 in.)

I/O connector<sup>1</sup> ..... 10-position modular jack (10P10C)

### Power requirement (from PCI channel)

#### PCI-8430/4

+5 VDC ..... 400 mA typical  
600 mA maximum

#### PCI-8431/4

+5 VDC ..... 725 mA typical  
1.1 A maximum

### Weight

PCI-8430/4 ..... 99 g

PCI-8431/4 ..... 102 g

### Maximum baud rate

PCI-8430/4 ..... 1 Mbps

PCI-8431/4 ..... 3 Mbps

Boards support any baud rate from 2 baud up to the maximum.

## PCI-8430/8 (RS-232) and PCI-8431/8 (RS-485/422)

Dimensions ..... 10.67 × 14.48 cm  
(4.2 × 5.7 in.)

I/O connector<sup>2</sup> ..... 68-pin, SCSI type connector

### Power requirement (from PCI channel)

#### PCI-8430/8

+5 VDC ..... 600 mA typical  
900 mA maximum

#### PCI-8431/8

+5 VDC ..... 1.3 A typical  
1.9 A maximum

---

<sup>1</sup> The four-port PCI serial boards require cables, included in your kit, to convert the 10-position modular jacks (10P10C) to DB-9 male connectors.

<sup>2</sup> The eight-port PCI serial boards require a cable, included in your kit, to convert the 68-pin connector to eight DB-9 connectors.



## Weight

|                 |      |
|-----------------|------|
| PCI-8430/8..... | 84 g |
| PCI-8431/8..... | 85 g |

## Maximum baud rate

|                 |        |
|-----------------|--------|
| PCI-8430/8..... | 1 Mbps |
| PCI-8431/8..... | 3 Mbps |

Boards support any baud rate from 2 baud up to the maximum.

## PCI-8430/16 (RS-232)

|                  |                                     |
|------------------|-------------------------------------|
| Dimensions ..... | 10.67 × 17.52 cm<br>(4.2 × 6.9 in.) |
|------------------|-------------------------------------|

|                                  |                   |
|----------------------------------|-------------------|
| I/O connector <sup>1</sup> ..... | 68-pin, VHDCI × 2 |
|----------------------------------|-------------------|

## Power requirement (from PCI channel)

|             |                                 |
|-------------|---------------------------------|
| PCI-8430/16 |                                 |
| +5 VDC..... | 935 mA typical<br>1.4 A maximum |

|             |      |
|-------------|------|
| Weight..... | 99 g |
|-------------|------|

|                        |        |
|------------------------|--------|
| Maximum baud rate..... | 1 Mbps |
|------------------------|--------|

Boards support any baud rate from 2 baud up to the maximum.

## PCI-8432/2 (RS-232) and PCI-8433/2 (RS-485/422)

|                  |                                     |
|------------------|-------------------------------------|
| Dimensions ..... | 10.67 × 17.52 cm<br>(4.2 × 6.9 in.) |
|------------------|-------------------------------------|

|                     |                     |
|---------------------|---------------------|
| I/O connector ..... | DB-9 male connector |
|---------------------|---------------------|

## Operating rated voltage (continuous)

|              |                |
|--------------|----------------|
| RS-232 ..... | -25 V to +25 V |
| RS-485 ..... | -7 V to + 12 V |

## Isolation voltages

### Port-to-port

|                  |   |
|------------------|---|
| Continuous ..... | 60 VDC (CAT I)  |
| Withstand .....  | 2000 V <sub>rms</sub> , verified by a 5 s dielectric withstand test |

### Port-to-host

|                  |   |
|------------------|---|
| Continuous ..... | 60 VDC (CAT I)  |
| Withstand .....  | 2000 V <sub>rms</sub> , verified by a 5 s dielectric withstand test |

---

<sup>1</sup> The 16-port PCI serial boards require two cables, included in your kit, to convert the two 68-pin connectors to the 16 (2 × 8) DB-9 male connectors.

Power requirement (from PCI channel)

PCI-8432/2

|             |                |
|-------------|----------------|
| +5 VDC..... | 380 mA typical |
|             | 570 mA maximum |

PCI-8433/2

|             |                |
|-------------|----------------|
| +5 VDC..... | 380 mA typical |
|             | 570 mA maximum |

Weight

|                 |       |
|-----------------|-------|
| PCI-8432/2..... | 102 g |
|-----------------|-------|

|                 |       |
|-----------------|-------|
| PCI-8433/2..... | 104 g |
|-----------------|-------|

Maximum baud rate

|                 |        |
|-----------------|--------|
| PCI-8432/2..... | 1 Mbps |
|-----------------|--------|

|                 |        |
|-----------------|--------|
| PCI-8433/2..... | 3 Mbps |
|-----------------|--------|

Boards support any baud rate from 2 baud up to the maximum.

PCI-8432/4 (RS-232) and PCI-8433/4 (RS-485/422)

|                  |                  |
|------------------|------------------|
| Dimensions ..... | 10.67 × 17.44 cm |
|                  | (4.2 × 6.9 in.)  |

|                                  |                                   |
|----------------------------------|-----------------------------------|
| I/O connector <sup>1</sup> ..... | 10-position modular jack (10P10C) |
|----------------------------------|-----------------------------------|

Operating rated voltage (continuous)

|              |                |
|--------------|----------------|
| RS-232 ..... | -25 V to +25 V |
|--------------|----------------|

|              |               |
|--------------|---------------|
| RS-485 ..... | -7 V to +12 V |
|--------------|---------------|

Isolation voltages

Port-to-port

|                 |                |
|-----------------|----------------|
| Continuous..... | 60 VDC (CAT I) |
|-----------------|----------------|

|                |  |
|----------------|--|
| Withstand..... | 2000 V <sub>rms</sub> , verified by a 5 s dielectric<br>withstand test |
|----------------|--|

Port-to-host

|                 |                |
|-----------------|----------------|
| Continuous..... | 60 VDC (CAT I) |
|-----------------|----------------|

|                |  |
|----------------|--|
| Withstand..... | 2000 V <sub>rms</sub> , verified by a 5 s dielectric<br>withstand test |
|----------------|--|

Power requirement (from PCI channel)

PCI-8432/4

|             |                |
|-------------|----------------|
| +5 VDC..... | 550 mA typical |
|             | 815 mA maximum |

PCI-8433/4

|             |                |
|-------------|----------------|
| +5 VDC..... | 785 mA typical |
|             | 1.2 A maximum  |

---

<sup>1</sup> The four-port PCI serial boards require cables, included in your kit, to convert the 10-position modular (10P10C) jacks to DB-9 male connectors.

## Weight

|                 |       |
|-----------------|-------|
| PCI-8432/4..... | 105 g |
| PCI-8433/4..... | 106 g |

## Maximum baud rate

|                 |        |
|-----------------|--------|
| PCI-8432/4..... | 1 Mbps |
| PCI-8433/4..... | 3 Mbps |

Boards support any baud rate from 2 baud up to the maximum.

## Environmental Characteristics (for All PCI Interfaces)

### Operating Environment

|                           |  |
|---------------------------|--|
| Ambient temperature ..... | 0 to 55 °C<br>(Tested in accordance with IEC-60068-2-1 and IEC-60068-2-2.) |
| Relative humidity.....    | 10 to 90%, noncondensing<br>(Tested in accordance with IEC-60068-2-56.)    |
| Altitude (maximum) .....  | 2,000 m  |
| Pollution Degree .....    | 2  |

Indoor use only.

### Storage Environment

|                           |  |
|---------------------------|--|
| Ambient temperature ..... | -20 to 70 °C<br>(Tested in accordance with IEC-60068-2-1 and IEC-60068-2-2.) |
| Relative humidity.....    | 5 to 95%, noncondensing<br>(Tested in accordance with IEC-60068-2-56.)       |

## Other Specifications (for All PCI Interfaces)

### Maximum cable length

|                           |   |
|---------------------------|---|
| RS-485 <sup>1</sup> ..... | 30 m (limited by EMC/surge)               |
| RS-232 .....              | 2,500 pF equivalent (TIA-EIA-232-F 2.1.4) |

### Data line ESD protection (human body model)

|              |        |
|--------------|--------|
| RS-485 ..... | ±15 kV |
| RS-232 ..... | ±15 kV |



**Note** This equipment is intended for indoor use only.

---

<sup>1</sup> RS-485 is capable of 1.2 km (4,000 ft) without surge limitation.

## Safety

This product meets the requirements of the following standards of safety for electrical equipment for measurement, control, and laboratory use:

- IEC 61010-1, EN 61010-1
- UL 61010-1, CSA 61010-1



**Note** For UL and other safety certifications, refer to the product label or the [Online Product Certification](#) section.

## Electromagnetic Compatibility

This product meets the requirements of the following EMC standards for electrical equipment for measurement, control, and laboratory use:

- EN 61326 (IEC 61326): Class A emissions; Basic immunity
- EN 55011 (CISPR 11): Group 1, Class A emissions
- AS/NZS CISPR 11: Group 1, Class A emissions
- FCC 47 CFR Part 15B: Class A emissions
- ICES-001: Class A emissions



**Note** For the standards applied to assess the EMC of this product, refer to the [Online Product Certification](#) section.



**Note** For EMC compliance, operate this device with shielded cabling.

## CE Compliance

This product meets the essential requirements of applicable European Directives as follows:

- 2006/95/EC; Low-Voltage Directive (safety)
- 2004/108/EC; Electromagnetic Compatibility Directive (EMC)

## Online Product Certification

Refer to the product Declaration of Conformity (DoC) for additional regulatory compliance information. To obtain product certifications and the DoC for this product, visit [ni.com/certification](http://ni.com/certification), search by model number or product line, and click the appropriate link in the Certification column.

## Environmental Management

NI is committed to designing and manufacturing products in an environmentally responsible manner. NI recognizes that eliminating certain hazardous substances from our products is beneficial to the environment and to NI customers.

For additional environmental information, refer to the *Minimize Our Environmental Impact* web page at [ni.com/environment](http://ni.com/environment). This page contains the environmental regulations and directives with which NI complies, as well as other environmental information not included in this document.

## Waste Electrical and Electronic Equipment (WEEE)



**EU Customers** At the end of the product life cycle, all products *must* be sent to a WEEE recycling center. For more information about WEEE recycling centers, National Instruments WEEE initiatives, and compliance with WEEE Directive 2002/96/EC on Waste and Electronic Equipment, visit [ni.com/environment/weee](http://ni.com/environment/weee).

## 电子信息产品污染控制管理办法（中国 RoHS）



**中国客户** National Instruments 符合中国电子信息产品中限制使用某些有害物质指令 (RoHS)。关于 National Instruments 中国 RoHS 合规性信息，请登录 [ni.com/environment/rohs\\_china](http://ni.com/environment/rohs_china)。(For information about China RoHS compliance, go to [ni.com/environment/rohs\\_china](http://ni.com/environment/rohs_china).)

## PCI Express Serial Hardware

This section describes the characteristics of the PCI Express serial hardware and the recommended operating conditions.

### NI PCIe-843x Series Hardware

#### NI PCIe-8430/8 (RS-232) and NI PCIe-8431/8 (RS-485/422)

Dimensions ..... 11.12 × 17.53 cm (4.38 × 6.9 in.)

#### I/O connectors

##### NI PCIe-8430/8

RS-232<sup>1</sup> ..... 68-pin VHDCI

PCI Express ..... x1

##### NI PCIe-8431/8

RS-485<sup>1</sup> ..... 68-pin VHDCI

PCI Express ..... x1

#### Power requirement (from PCI Express channel)

##### NI PCIe-8430/8

+3.3 VDC ..... 200 mA typical  
750 mA maximum

+12 VDC ..... 190 mA typical  
220 mA maximum

##### NI PCIe-8431/8

+3.3 VDC<sup>2</sup> ..... 700 mA typical, 1.5 A maximum

+12 VDC ..... 190 mA typical  
220 mA maximum

<sup>1</sup> The 8-port PCI Express serial boards require a cable, included in your kit, to convert the 68-pin connector to eight DB-9 male connectors.

<sup>2</sup> These values are based on the assumption that all 16 ports (for the NI PCIe-8431/16) or 8 ports (for the NI PCIe-8431/8) are using a 620 Ω bias resistor and NI-offered terminators installed on both ends of the cable.

## Weight

|                     |      |
|---------------------|------|
| NI PCIe-8430/8..... | 88 g |
| NI PCIe-8431/8..... | 90 g |

## Maximum baud rate

|                     |        |
|---------------------|--------|
| NI PCIe-8430/8..... | 1 Mbps |
| NI PCIe-8431/8..... | 3 Mbps |

Boards support any baud rate from 2 baud up to the maximum.

## NI PCIe-8430/16 (RS-232) and NI PCIe-8431/16 (RS-485/422)

Dimensions ..... 11.12 × 17.53 cm (4.38 × 6.9 in.)

## I/O connectors

### NI PCIe-8430/16

|                           |                  |
|---------------------------|------------------|
| RS-232 <sup>1</sup> ..... | 68-pin VHDCI × 2 |
| PCI Express .....         | x1               |

### NI PCIe-8431/16

|                           |                  |
|---------------------------|------------------|
| RS-485 <sup>1</sup> ..... | 68-pin VHDCI × 2 |
| PCI Express .....         | x1               |

## Power requirement (from PCI Express channel)

### NI PCIe-8430/16

|               |                                  |
|---------------|----------------------------------|
| +3.3 VDC..... | 400 mA typical, 1.5 A maximum    |
| +12 VDC.....  | 210 mA typical<br>250 mA maximum |

### NI PCIe-8431/16

|                             |                                  |
|-----------------------------|----------------------------------|
| +3.3 VDC <sup>2</sup> ..... | 1.4 A typical, 3 A maximum       |
| +12 VDC.....                | 210 mA typical<br>250 mA maximum |

## Weight

|                      |       |
|----------------------|-------|
| NI PCIe-8430/16..... | 99 g  |
| NI PCIe-8431/16..... | 101 g |

## Maximum baud rate

|                      |        |
|----------------------|--------|
| NI PCIe-8430/16..... | 1 Mbps |
| NI PCIe-8431/16..... | 3 Mbps |

Boards support any baud from 2 baud up to the maximum.

---

<sup>1</sup> The 16-port PCI Express serial boards require two cables, included in your kit, to convert the two 68-pin connectors to the 16 (2 × 8) DB-9 male connectors.

<sup>2</sup> These values are based on the assumption that all 16 ports (for the NI PCIe-8431/16) or 8 ports (for the NI PCIe-8431/8) are using a 620 Ω bias resistor and NI-offered terminators installed on both ends of the cable.

## NI PCIe-8432/2 (RS-232) and NI PCIe-8433/2 (RS-485/422)

Dimensions ..... 11.12 × 16.67 cm (4.38 × 6.6 in.)

### I/O connectors

NI PCIe-8432/2 ..... DB-9 male connector

NI PCIe-8433/2 ..... DB-9 male connector

### Operating rated voltage (continuous)

RS-232 ..... -25 V to +25 V

RS-485 ..... -7 V to +12 V

### Isolation voltages

#### Port-to-port

Continuous ..... 60 VDC (CAT I)

Withstand ..... 2000 V<sub>rms</sub>, verified by a 5 s dielectric  
withstand test

#### Port-to-host

Continuous ..... 60 VDC (CAT I)

Withstand ..... 2000 V<sub>rms</sub>, verified by a 5 s dielectric  
withstand test

### Power requirement (from PCI Express channel)

#### NI PCIe-8432/2

+12 VDC ..... 55 mA typical  
160 mA maximum

+3.3 VDC ..... 610 mA typical  
650 mA maximum

#### NI PCIe-8433/2

+12 VDC ..... 140 mA typical  
240 mA maximum

+3.3 VDC ..... 610 mA typical  
660 mA maximum

### Weight

NI PCIe-8432/2 ..... 90.7 g

NI PCIe-8433/2 ..... 90.7 g

### Maximum serial transfer rate

RS-232 ..... 1 Mbps

RS-485 ..... 3 Mbps

# Environmental Characteristics (for All PCI Express Interfaces)

## Operating Environment

|                           |  |
|---------------------------|--|
| Ambient temperature ..... | 0 to 55 °C<br>(Tested in accordance with IEC-60068-2-1 and IEC-60068-2-2.) |
| Relative humidity .....   | 10 to 90%, noncondensing<br>(Tested in accordance with IEC-60068-2-56.)    |
| Altitude (maximum) .....  | 2,000 m  |
| Indoor use only.          |  |

## Storage Environment

|                           |  |
|---------------------------|--|
| Ambient temperature ..... | -20 to 70 °C<br>(Tested in accordance with IEC-60068-2-1 and IEC-60068-2-2.) |
| Relative humidity .....   | 5 to 95%, noncondensing<br>(Tested in accordance with IEC-60068-2-56.)       |

## Other Specifications (for All PCI Express Interfaces)

### Maximum cable length

|                           |   |
|---------------------------|---|
| RS-485 <sup>1</sup> ..... | 30 m (limited by EMC/surge)               |
| RS-232 .....              | 2,500 pF equivalent (TIA-EIA-232-F 2.1.4) |

### Data line ESD protection (human body model)

|              |        |
|--------------|--------|
| RS-485 ..... | ±15 kV |
| RS-232 ..... | ±15 kV |

### Baud rate accuracy

|              |   |
|--------------|---|
| RS-232 ..... | Within 0.015% for standard baud rate<br>Within 0.5% for nonstandard baud rate   |
| RS-485 ..... | Within 0.015% for standard baud rate<br>Within 0.5% for nonstandard baud rate below 1 Mbps<br>Within 1.3% for nonstandard baud rate between 1 Mbps and 3 Mbps |



**Note** This equipment is intended for indoor use only.

## Safety

This product meets the requirements of the following standards of safety for electrical equipment for measurement, control, and laboratory use:

- IEC 61010-1, EN 61010-1

---

<sup>1</sup> RS-485 is capable of 1.2 km (4,000 ft) without surge limitation.



- UL 61010-1, CSA 61010-1



**Note** For UL and other safety certifications, refer to the product label or the [Online Product Certification](#) section.

## Electromagnetic Compatibility

This product meets the requirements of the following EMC standards for electrical equipment for measurement, control, and laboratory use:

- EN 61326 (IEC 61326): Class A emissions; Basic immunity
- EN 55011 (CISPR 11): Group 1, Class A emissions
- AS/NZS CISPR 11: Group 1, Class A emissions
- FCC 47 CFR Part 15B: Class A emissions
- ICES-001: Class A emissions



**Note** For the standards applied to assess the EMC of this product, refer to the [Online Product Certification](#) section.



**Note** For EMC compliance, operate this device with shielded cabling.

## CE Compliance

This product meets the essential requirements of applicable European Directives as follows:

- 2006/95/EC; Low-Voltage Directive (safety)
- 2004/108/EC; Electromagnetic Compatibility Directive (EMC)

## Online Product Certification

Refer to the product Declaration of Conformity (DoC) for additional regulatory compliance information. To obtain product certifications and the DoC for this product, visit [ni.com/certification](http://ni.com/certification), search by model number or product line, and click the appropriate link in the Certification column.

## Environmental Management

NI is committed to designing and manufacturing products in an environmentally responsible manner. NI recognizes that eliminating certain hazardous substances from our products is beneficial to the environment and to NI customers.

For additional environmental information, refer to the *Minimize Our Environmental Impact* web page at [ni.com/environment](http://ni.com/environment). This page contains the environmental regulations and directives with which NI complies, as well as other environmental information not included in this document.

## Waste Electrical and Electronic Equipment (WEEE)



**EU Customers** At the end of the product life cycle, all products *must* be sent to a WEEE recycling center. For more information about WEEE recycling centers, National Instruments WEEE initiatives, and compliance with WEEE Directive 2002/96/EC on Waste and Electronic Equipment, visit [ni.com/environment/weee](http://ni.com/environment/weee).

## 电子信息产品污染控制管理办法（中国 RoHS）



**中国客户** National Instruments 符合中国电子信息产品中限制使用某些有害物质指令 (RoHS)。关于 National Instruments 中国 RoHS 合规性信息，请登录 [ni.com/environment/rohs\\_china](http://ni.com/environment/rohs_china)。(For information about China RoHS compliance, go to [ni.com/environment/rohs\\_china](http://ni.com/environment/rohs_china).)

## PXI Serial Hardware

This section describes the characteristics of the PXI serial hardware and the recommended operating conditions.

### PXI-843x Serial Hardware

#### PXI-8430/2 (RS-232) and PXI-8431/2 (RS-485/422)

|                                      |                                   |
|--------------------------------------|-----------------------------------|
| Dimensions .....                     | 100 × 160 mm<br>(3.94 × 6.37 in.) |
| I/O connector .....                  | DB-9 male connector               |
| Power requirement (from PXI channel) |                                   |
| PXI-8430/2                           |                                   |
| +5 VDC.....                          | 325 mA typical<br>500 mA maximum  |
| PXI-8431/2                           |                                   |
| +5 VDC.....                          | 500 mA typical<br>750 mA maximum  |
| Weight                               |                                   |
| PXI-8430/2 .....                     | 134 g                             |
| PXI-8431/2 .....                     | 134 g                             |
| Maximum baud rate                    |                                   |
| PXI-8430/2 .....                     | 1 Mbps                            |
| PXI-8431/2 .....                     | 3 Mbps                            |

Boards support any baud rate from 2 baud up to the maximum.

## PXI-8430/4 (RS-232) and PXI-8431/4 (RS-485/422)

Dimensions ..... 100 × 160 mm  
(3.94 × 6.37 in.)

I/O connector<sup>1</sup> ..... 10-position modular jack (10P10C)

### Power requirement (from PXI channel)

PXI-8430/4  
+5 VDC ..... 400 mA typical  
600 mA maximum

PXI-8431/4  
+5 VDC ..... 725 mA typical  
1.1 A maximum

### Weight

PXI-8430/4 ..... 137 g  
PXI-8431/4 ..... 140 g

### Maximum baud rate

PXI-8430/4 ..... 1 Mbps  
PXI-8431/4 ..... 3 Mbps

Boards support any baud rate from 2 baud up to the maximum.

## PXI-8430/8 (RS-232) and PXI-8431/8 (RS-485/422)

Dimensions ..... 100 × 160 mm  
(3.94 × 6.37 in.), 3U

I/O connector<sup>2</sup> ..... 68-pin SCSI (68-pin SCSI to eight DB-9 male  
connector adapter cable included)

### Power requirement (from PXI channel)

PXI-8430/8  
+5 VDC ..... 1 A typical  
1.5 A maximum

PXI-8431/8  
+5 VDC ..... 925 mA typical  
1.4 A maximum

### Weight

PXI-8430/8 ..... 135 g  
PXI-8431/8 ..... 137 g

---

<sup>1</sup> The four-port PXI serial boards require cables, included in your kit, to convert the 10-position modular jacks (10P10C) to DB-9 male connectors.

<sup>2</sup> The eight-port PXI serial boards require a cable, included in your kit, to convert the 68-pin connector to eight DB-9 connectors.

## Shock and vibration

|                         |  |
|-------------------------|--|
| Operational shock ..... | 30 g peak, half-sine, 11 ms pulse<br>(Tested in accordance with IEC-60068-2-27.<br>Test profile developed in accordance with<br>MIL-PRF-28800F.) |
|-------------------------|--|

## Maximum baud rate

|                  |        |
|------------------|--------|
| PXI-8430/8 ..... | 1 Mbps |
| PXI-8431/8 ..... | 3 Mbps |

Boards support any baud rate from 2 baud up to the maximum.

## PXI-8430/16 (RS-232)

|                  |                                       |
|------------------|---------------------------------------|
| Dimensions ..... | 100 × 160 mm<br>(3.94 × 6.37 in.), 3U |
|------------------|---------------------------------------|

I/O connector<sup>1</sup>..... 68-pin VHDCI × 2

## Power requirement (from PXI channel)

|             |                                 |
|-------------|---------------------------------|
| PXI-8430/16 |                                 |
| +5 VDC..... | 935 mA typical<br>1.4 A maximum |

Weight..... 157 g

Maximum baud rate..... 1 Mbps

Boards support any baud rate from 2 baud up to the maximum.

## PXI-8432/2 (RS-232) and PXI-8433/2 (RS-485/422)

|                  |                                       |
|------------------|---------------------------------------|
| Dimensions ..... | 100 × 160 mm<br>(3.94 × 6.37 in.), 3U |
|------------------|---------------------------------------|

I/O connector .....

|                         |
|-------------------------|
| DB-9 male connector × 2 |
|-------------------------|

## Operating rated voltage (continuous)

|              |                |
|--------------|----------------|
| RS-232 ..... | -25 V to +25 V |
| RS-485 ..... | -7 V to +12 V  |

## Isolation voltages

### Port-to-port

|                 |  |
|-----------------|--|
| Continuous..... | 60 VDC (CAT I)   |
| Withstand.....  | 2000 V <sub>rms</sub> , verified by a 5 s dielectric<br>withstand test |

---

<sup>1</sup> The 16-port PXI serial boards require two cables, included in your kit, to convert the two 68-pin connectors to the 16 (2 × 8) DB-9 male connectors.

Port-to-host

|                  |   |
|------------------|---|
| Continuous ..... | 60 VDC (CAT I)  |
| Withstand .....  | 2000 V <sub>rms</sub> , verified by a 5 s dielectric withstand test |

Power requirement (from PXI channel)

|              |                               |
|--------------|-------------------------------|
| PXI-8432/2   |                               |
| +5 VDC ..... | 725 mA typical<br>1 A maximum |
| PXI-8433/2   |                               |
| +5 VDC ..... | 725 mA typical<br>1 A maximum |

Weight

|                 |       |
|-----------------|-------|
| PXI-8432/2..... | 125 g |
| PXI-8433/2..... | 125 g |

Shock and vibration

|                         |   |
|-------------------------|---|
| Operational shock ..... | 30 g peak, half-sine, 11 ms pulse<br>(Tested in accordance with IEC-60068-2-27.<br>Test profile developed in accordance with MIL-PRF-28800F.) |
|-------------------------|---|

Random vibration

|                    |  |
|--------------------|--|
| Operating .....    | 5 to 500 Hz, 0.3 g <sub>rms</sub>  |
| Nonoperating ..... | 5 to 500 Hz, 2.4 g <sub>rms</sub><br>(Tested in accordance with IEC-60068-2-64.<br>Nonoperating test profile exceeds the requirements of MIL-PRF-28800F, Class 3.) |

Maximum baud rate

|                 |        |
|-----------------|--------|
| PXI-8432/2..... | 1 Mbps |
| PXI-8433/2..... | 3 Mbps |

Boards support any baud rate from 2 baud up to the maximum.

PXI-8432/4 (RS-232) and PXI-8433/4 (RS-485/422)

|                  |                                       |
|------------------|---------------------------------------|
| Dimensions ..... | 100 × 160 mm<br>(3.94 × 6.37 in.), 3U |
|------------------|---------------------------------------|

I/O connector<sup>1</sup>..... 10-position modular jack (10P10C)

Operating rated voltage (continuous)

|              |                |
|--------------|----------------|
| RS-232 ..... | -25 V to +25 V |
| RS-485 ..... | -7 V to + 12 V |

<sup>1</sup> The four-port PXI serial boards require cables, included in your kit, to convert the 10-position modular jacks (10P10C) to DB-9 male connectors.

## Isolation voltages

### Port-to-port

|                 |   |
|-----------------|---|
| Continuous..... | 60 VDC (CAT I)  |
| Withstand.....  | 2000 V <sub>rms</sub> , verified by a 5 s dielectric withstand test |

### Port-to-host

|                 |   |
|-----------------|---|
| Continuous..... | 60 VDC (CAT I)  |
| Withstand.....  | 2000 V <sub>rms</sub> , verified by a 5 s dielectric withstand test |

## Power requirement (from PXI channel)

### PXI-8432/4

|             |                               |
|-------------|-------------------------------|
| +5 VDC..... | 925 mA typical<br>2 A maximum |
|-------------|-------------------------------|

### PXI-8433/4

|             |                               |
|-------------|-------------------------------|
| +5 VDC..... | 950 mA typical<br>2 A maximum |
|-------------|-------------------------------|

## Weight

|                  |       |
|------------------|-------|
| PXI-8432/4 ..... | 147 g |
| PXI-8433/4 ..... | 147 g |

## Maximum baud rate

|                  |        |
|------------------|--------|
| PXI-8432/4 ..... | 1 Mbps |
| PXI-8433/4 ..... | 3 Mbps |

Boards support any baud rate from 2 baud up to the maximum.

## Environmental Characteristics (for All PXI Interfaces)

### Operating Environment

|                           |  |
|---------------------------|--|
| Ambient temperature ..... | 0 to 55 °C<br>(Tested in accordance with IEC-60068-2-1 and IEC-60068-2-2.) |
| Relative humidity .....   | 10 to 90%, noncondensing<br>(Tested in accordance with IEC-60068-2-56.)    |
| Altitude (maximum) .....  | 2,000 m  |
| Pollution Degree .....    | 2  |

Indoor use only.

### Storage Environment

|                           |  |
|---------------------------|--|
| Ambient temperature ..... | -20 to 70 °C<br>(Tested in accordance with IEC-60068-2-1 and IEC-60068-2-2.) |
|---------------------------|--|

Relative humidity ..... 5 to 95%, noncondensing  
(Tested in accordance with IEC-60068-2-56.)

## Other Specifications (for All PXI Interfaces)

### Maximum cable length

RS-485<sup>1</sup> ..... 30 m (limited by EMC/surge)  
RS-232 ..... 2,500 pF equivalent (TIA-EIA-232-F 2.1.4)

### Data line ESD protection (human body model)

RS-485 ..... ±15 kV  
RS-232 ..... ±15 kV



**Note** This equipment is intended for indoor use only.

## Safety

This product meets the requirements of the following standards of safety for electrical equipment for measurement, control, and laboratory use:

- IEC 61010-1, EN 61010-1
- UL 61010-1, CSA 61010-1



**Note** For UL and other safety certifications, refer to the product label or the [Online Product Certification](#) section.

## Electromagnetic Compatibility

This product meets the requirements of the following EMC standards for electrical equipment for measurement, control, and laboratory use:

- EN 61326 (IEC 61326): Class A emissions; Basic immunity
- EN 55011 (CISPR 11): Group 1, Class A emissions
- AS/NZS CISPR 11: Group 1, Class A emissions
- FCC 47 CFR Part 15B: Class A emissions
- ICES-001: Class A emissions



**Note** For the standards applied to assess the EMC of this product, refer to the [Online Product Certification](#) section.



**Note** For EMC compliance, operate this device with shielded cabling.

## CE Compliance

This product meets the essential requirements of applicable European Directives as follows:

- 2006/95/EC; Low-Voltage Directive (safety)
- 2004/108/EC; Electromagnetic Compatibility Directive (EMC)

---

<sup>1</sup> RS-485 is capable of 1.2 km (4,000 ft) without surge limitation.

## Online Product Certification

Refer to the product Declaration of Conformity (DoC) for additional regulatory compliance information. To obtain product certifications and the DoC for this product, visit [ni.com/certification](http://ni.com/certification), search by model number or product line, and click the appropriate link in the Certification column.

## Environmental Management

NI is committed to designing and manufacturing products in an environmentally responsible manner. NI recognizes that eliminating certain hazardous substances from our products is beneficial to the environment and to NI customers.

For additional environmental information, refer to the *Minimize Our Environmental Impact* web page at [ni.com/environment](http://ni.com/environment). This page contains the environmental regulations and directives with which NI complies, as well as other environmental information not included in this document.

## Waste Electrical and Electronic Equipment (WEEE)



**EU Customers** At the end of the product life cycle, all products *must* be sent to a WEEE recycling center. For more information about WEEE recycling centers, National Instruments WEEE initiatives, and compliance with WEEE Directive 2002/96/EC on Waste and Electronic Equipment, visit [ni.com/environment/weee](http://ni.com/environment/weee).

## 电子信息产品污染控制管理办法（中国 RoHS）



**中国客户** National Instruments 符合中国电子信息产品中限制使用某些有害物质指令 (RoHS)。关于 National Instruments 中国 RoHS 合规性信息，请登录 [ni.com/environment/rohs\\_china](http://ni.com/environment/rohs_china)。(For information about China RoHS compliance, go to [ni.com/environment/rohs\\_china](http://ni.com/environment/rohs_china).)

## PXI Express Serial Hardware

This section describes the characteristics of the PXI Express serial hardware and the recommended operating conditions.

### NI PXIe-843x Serial Hardware

#### NI PXIe-8430/8 (RS-232) and NI PXIe-8431/8 (RS-485/422)

Dimensions ..... 100 × 160 mm  
(3.94 × 6.37 in.), 3U

I/O connector<sup>1</sup> ..... 68-pin VHDCI

Power requirement (from PXI Express channel)

NI PXIe-8430/8

+12 VDC ..... 220 mA typical

<sup>1</sup> The eight-port PXI Express serial boards require a cable, included in your kit, to convert the 68-pin connector to eight DB-9 connectors.



|                             |                                  |
|-----------------------------|----------------------------------|
|                             | 250 mA maximum                   |
| +3.3 VDC.....               | 200 mA typical<br>750 mA maximum |
| NI PXIe-8431/8              |                                  |
| +12 VDC.....                | 220 mA typical<br>240 mA maximum |
| +3.3 VDC <sup>1</sup> ..... | 0.7 A typical<br>1.5 A maximum   |

#### Weight

|                     |       |
|---------------------|-------|
| NI PXIe-8430/8..... | 143 g |
| NI PXIe-8431/8..... | 143 g |

#### Maximum baud rate

|                     |                     |
|---------------------|---------------------|
| NI PXIe-8430/8..... | 1 Mbps              |
| NI PXIe-8431/8..... | 3 Mbps <sup>2</sup> |

Boards support any baud rate from 2 baud up to the maximum.

#### Baud rate accuracy

|                     |   |
|---------------------|---|
| NI PXIe-8430/8..... | Within 0.015% for standard baud rate<br>Within 0.5% for nonstandard baud rate   |
| NI PXIe-8431/8..... | Within 0.015% for standard baud rate<br>Within 0.5% for nonstandard baud rate below<br>1 Mbps<br>Within 1.3% for nonstandard baud rate between<br>1 Mbps and 3 Mbps |

#### NI PXIe-8430/16 (RS-232) and NI PXIe-8431/16 (RS-485/422)

|                  |                                       |
|------------------|---------------------------------------|
| Dimensions ..... | 100 × 160 mm<br>(3.94 × 6.37 in.), 3U |
|------------------|---------------------------------------|

|                                  |                  |
|----------------------------------|------------------|
| I/O connector <sup>3</sup> ..... | 68-pin VHDCI × 2 |
|----------------------------------|------------------|

#### Power requirement (from PXI Express channel)

|                 |                                  |
|-----------------|----------------------------------|
| NI PXIe-8430/16 |                                  |
| +12 VDC.....    | 250 mA typical<br>270 mA maximum |
| +3.3 VDC.....   | 400 mA typical<br>1.5 A maximum  |

<sup>1</sup> These values are based on the assumption that all 16 ports (for the NI PXIe-8431/16) or 8 ports (for the NI PXIe-8431/8) are using a 620 Ω bias resistor and NI-offered terminators installed on both ends of the cable.

<sup>2</sup> For possible use with higher baud rates, refer to [ni.com/kb](http://ni.com/kb) and search for KnowledgeBase's **KB58KEI82F**.

<sup>3</sup> The 16-port PXI Express serial boards require two cables, included in your kit, to convert the two 68-pin connectors to the 16 (2 × 8) DB-9 male connectors.

|                             |                                  |
|-----------------------------|----------------------------------|
| NI PXIe-8431/16             |                                  |
| +12 VDC.....                | 250 mA typical<br>280 mA maximum |
| +3.3 VDC <sup>1</sup> ..... | 1.4 A typical<br>3 A maximum     |

Weight

|                       |       |
|-----------------------|-------|
| NI PXIe-8430/16 ..... | 152 g |
| NI PXIe-8431/16 ..... | 155 g |

Maximum baud rate

|                       |                     |
|-----------------------|---------------------|
| NI PXIe-8430/16 ..... | 1 Mbps              |
| NI PXIe-8431/16 ..... | 3 Mbps <sup>2</sup> |

Boards support any baud rate from 2 baud up to the maximum.

Baud rate accuracy

|                       |  |
|-----------------------|--|
| NI PXIe-8430/16 ..... | Within 0.015% for standard baud rate<br>Within 0.5% for nonstandard baud rate  |
| NI PXIe-8431/16 ..... | Within 0.015% for standard baud rate<br>Within 0.5% for nonstandard baud rate below<br>1 M<br>Within 1.3% for nonstandard baud rate between<br>1 M and 3 M |

## Environmental Characteristics (for All PXI Express Interfaces)

### Operating Environment

|                           |  |
|---------------------------|--|
| Ambient temperature ..... | 0 to 55 °C<br>(Tested in accordance with IEC-60068-2-1 and IEC-60068-2-2. Meets MIL-PRF-28800F Class 3 low temperature limit and MIL-PRF-28800F Class 2 high temperature limit.) |
| Relative humidity .....   | 10 to 90%, noncondensing<br>(Tested in accordance with IEC-60068-2-56.)  |
| Altitude (maximum) .....  | 2,000 m  |
| Pollution degree .....    | 2  |

Indoor use only.

<sup>1</sup> These values are based on the assumption that all 16 ports (for the NI PXIe-8431/16) or 8 ports (for the NI PXIe-8431/8) are using a 620 Ω bias resistor and NI-offered terminators installed on both ends of the cable.

<sup>2</sup> For possible use with higher baud rates, refer to [ni.com/kb](#) and search for KnowledgeBase **KB58KEI82F**.

## Storage Environment

|                           |   |
|---------------------------|---|
| Ambient temperature ..... | -40 to 71 °C<br>(Tested in accordance with IEC-60068-2-1 and IEC-60068-2-2. Meets MIL-PRF-28800F Class 3 limits.) |
| Relative humidity .....   | 5 to 95%, noncondensing<br>(Tested in accordance with IEC-60068-2-56.)  |

## Other Specifications (for All PXI Express Interfaces)

### Maximum cable length

|                           |   |
|---------------------------|---|
| RS-485 <sup>1</sup> ..... | 30 m (limited by EMC/surge)               |
| RS-232 .....              | 2,500 pF equivalent (TIA-EIA-232-F 2.1.4) |

### Data line ESD protection (human body model)

|              |        |
|--------------|--------|
| RS-485 ..... | ±15 kV |
| RS-232 ..... | ±15 kV |

### Shock and vibration

|                         |   |
|-------------------------|---|
| Operational shock ..... | 30 g peak, half-sine, 11 ms pulse<br>(Tested in accordance with IEC-60068-2-27. Meets MIL-PRF-28800F Class 2 limits.) |
|-------------------------|---|

### Random vibration

|                    |   |
|--------------------|---|
| Operating .....    | 5 to 500 Hz, 0.3 g <sub>rms</sub>   |
| Nonoperating ..... | 5 to 500 Hz, 2.4 g <sub>rms</sub><br>(Tested in accordance with IEC-60068-2-64. Nonoperating test profile exceeds the requirements of MIL-PRF-28800F, Class 3.) |



**Note** This equipment is intended for indoor use only.

## Safety

This product meets the requirements of the following standards of safety for electrical equipment for measurement, control, and laboratory use:

- IEC 61010-1, EN 61010-1
- UL 61010-1, CSA 61010-1



**Note** For UL and other safety certifications, refer to the product label or the [Online Product Certification](#) section.

## Electromagnetic Compatibility

This product meets the requirements of the following EMC standards for electrical equipment for measurement, control, and laboratory use:

---

<sup>1</sup> RS-485 is capable of 1.2 km (4,000 ft) without surge limitation.

- EN 61326 (IEC 61326): Class A emissions; Basic immunity
- EN 55011 (CISPR 11): Group 1, Class A emissions
- AS/NZS CISPR 11: Group 1, Class A emissions
- FCC 47 CFR Part 15B: Class A emissions
- ICES-001: Class A emissions



**Note** For the standards applied to assess the EMC of this product, refer to the [Online Product Certification](#) section.



**Note** For EMC compliance, operate this device with shielded cabling.

## CE Compliance

This product meets the essential requirements of applicable European Directives as follows:

- 2006/95/EC; Low-Voltage Directive (safety)
- 2004/108/EC; Electromagnetic Compatibility Directive (EMC)

## Online Product Certification

Refer to the product Declaration of Conformity (DoC) for additional regulatory compliance information. To obtain product certifications and the DoC for this product, visit [ni.com/certification](http://ni.com/certification), search by model number or product line, and click the appropriate link in the Certification column.

## Environmental Management

NI is committed to designing and manufacturing products in an environmentally responsible manner. NI recognizes that eliminating certain hazardous substances from our products is beneficial to the environment and to NI customers.

For additional environmental information, refer to the *Minimize Our Environmental Impact* web page at [ni.com/environment](http://ni.com/environment). This page contains the environmental regulations and directives with which NI complies, as well as other environmental information not included in this document.

## Waste Electrical and Electronic Equipment (WEEE)



**EU Customers** At the end of the product life cycle, all products *must* be sent to a WEEE recycling center. For more information about WEEE recycling centers, National Instruments WEEE initiatives, and compliance with WEEE Directive 2002/96/EC on Waste and Electronic Equipment, visit [ni.com/environment/weee](http://ni.com/environment/weee).

## 电子信息产品污染控制管理办法（中国 RoHS）



**中国客户** National Instruments 符合中国电子信息产品中限制使用某些有害物质指令 (RoHS)。关于 National Instruments 中国 RoHS 合规性信息，请登录 [ni.com/environment/rohs\\_china](http://ni.com/environment/rohs_china)。(For information about China RoHS compliance, go to [ni.com/environment/rohs\\_china](http://ni.com/environment/rohs_china).)

# USB Serial Hardware

This section describes the characteristics of the USB serial hardware and the recommended operating conditions.

## USB-232 (RS-232) and USB-485 (RS-485/422)

|                                      |  |
|--------------------------------------|--|
| Dimensions .....                     | 3.81 × 3.56 × 1.52 cm<br>(1.5 × 1.4 × 0.6 in.) |
| Case material.....                   | PVC  |
| Weight                               |  |
| USB-232 .....                        | 121 g (0.27 lb)                                |
| USB-485 .....                        | 118 g (0.26 lb)                                |
| I/O connector .....                  | DB-9 male connector                            |
| USB connector .....                  | Captive cable with USB series A plug           |
| Power requirement (from USB channel) |  |
| USB-485                              |  |
| +5 VDC.....                          | 175 mA typical<br>500 mA maximum               |
| USB-232                              |  |
| +5 VDC.....                          | 80 mA typical<br>100 mA maximum                |
| Maximum baud rate                    |  |
| USB-232 .....                        | 230.4 kbps                                     |
| USB-485 .....                        | 460.8 kbps                                     |

Boards support standard baud rates below the maximum.

## USB-232/2, USB-232/4 (USB-232), USB-485/2, and USB-485/4 (RS-485/422)

|                                      |  |
|--------------------------------------|--|
| Dimensions .....                     | 21.08 × 12.45 × 3.56 cm<br>(8.3 × 4.9 × 1.4 in.) |
| Case material.....                   | Hard plastic with metal baseplate                |
| Weight.....                          | 375 g (0.83 lb)                                  |
| I/O connector .....                  | DB-9 male connector                              |
| USB connector .....                  | USB series B                                     |
| Power requirement (from USB channel) |  |
| USB-485/2                            |  |
| +5 VDC.....                          | 300 mA typical<br>500 mA maximum                 |
| USB-232/2                            |  |

|             |                                  |
|-------------|----------------------------------|
| +5 VDC..... | 200 mA typical<br>500 mA maximum |
| USB-232/4   |                                  |
| +5 VDC..... | 300 mA typical<br>500 mA maximum |

Power requirement (from external supply)

|                        |                                  |
|------------------------|----------------------------------|
| USB-485/4 (9 V-30 V)   |                                  |
| +12 VDC (typical)..... | 225 mA typical<br>500 mA maximum |

Maximum baud rate

|                              |            |
|------------------------------|------------|
| USB-232/2 and USB-232/4..... | 230.4 kbps |
| USB-485/2 and USB-485/4..... | 460.8 kbps |

Boards support standard baud rates below the maximum.

## Environmental Characteristics (for All USB Interfaces)

### Operating Environment

|                          |  |
|--------------------------|--|
| Ambient temperature..... | 0 to 70 °C<br>(Tested in accordance with IEC-60068-2-1 and IEC-60068-2-2.) |
| Relative humidity.....   | 10 to 90%, noncondensing<br>(Tested in accordance with IEC-60068-2-56.)    |
| Altitude (maximum).....  | 2,000 m  |
| Pollution Degree.....    | 2  |

Indoor use only.

### Storage Environment

|                        |  |
|------------------------|--|
| Ambient temperature    |  |
| One port.....          | -40 to 80 °C<br>(Tested in accordance with IEC-60068-2-1 and IEC-60068-2-2.) |
| Two and four port..... | -40 to 85 °C<br>(Tested in accordance with IEC-60068-2-1 and IEC-60068-2-2.) |
| Relative humidity..... | 5 to 95%, noncondensing<br>(Tested in accordance with IEC-60068-2-56.)       |

## Other Specifications (for All USB Interfaces)

Maximum cable length

|                           |   |
|---------------------------|---|
| RS-485 <sup>1</sup> ..... | 30 m (limited by EMC/surge)               |
| RS-232.....               | 2,500 pF equivalent (TIA-EIA-232-F 2.1.4) |

## Data line ESD protection (human body model)

RS-485 .....±15 kV

RS-232 .....±15 kV



**Note** This equipment is intended for indoor use only.

## Safety

This product meets the requirements of the following standards of safety for electrical equipment for measurement, control, and laboratory use:

- IEC 61010-1, EN 61010-1
- UL 61010-1, CSA 61010-1



**Note** For UL and other safety certifications, refer to the product label or the [Online Product Certification](#) section.

## Electromagnetic Compatibility

This product meets the requirements of the following EMC standards for electrical equipment for measurement, control, and laboratory use:

- EN 61326 (IEC 61326): Class A emissions; Basic immunity
- EN 55011 (CISPR 11): Group 1, Class A emissions
- AS/NZS CISPR 11: Group 1, Class A emissions
- FCC 47 CFR Part 15B: Class A emissions
- ICES-001: Class A emissions



**Note** For the standards applied to assess the EMC of this product, refer to the [Online Product Certification](#) section.



**Note** For EMC compliance, operate this device with shielded cabling.

## CE Compliance

This product meets the essential requirements of applicable European Directives as follows:

- 2006/95/EC; Low-Voltage Directive (safety)
- 2004/108/EC; Electromagnetic Compatibility Directive (EMC)

## Online Product Certification

Refer to the product Declaration of Conformity (DoC) for additional regulatory compliance information. To obtain product certifications and the DoC for this product, visit [ni.com/certification](http://ni.com/certification), search by model number or product line, and click the appropriate link in the Certification column.

---

<sup>1</sup> RS-485 is capable of 1.2 km (4,000 ft) without surge limitation.

# Environmental Management

NI is committed to designing and manufacturing products in an environmentally responsible manner. NI recognizes that eliminating certain hazardous substances from our products is beneficial to the environment and to NI customers.

For additional environmental information, refer to the *Minimize Our Environmental Impact* web page at [ni.com/environment](http://ni.com/environment). This page contains the environmental regulations and directives with which NI complies, as well as other environmental information not included in this document.

## Waste Electrical and Electronic Equipment (WEEE)



**EU Customers** At the end of the product life cycle, all products *must* be sent to a WEEE recycling center. For more information about WEEE recycling centers, National Instruments WEEE initiatives, and compliance with WEEE Directive 2002/96/EC on Waste and Electronic Equipment, visit [ni.com/environment/weee](http://ni.com/environment/weee).

## 电子信息产品污染控制管理办法（中国 RoHS）



**中国客户** National Instruments 符合中国电子信息产品中限制使用某些有害物质指令 (RoHS)。关于 National Instruments 中国 RoHS 合规性信息，请登录 [ni.com/environment/rohs\\_china](http://ni.com/environment/rohs_china)。(For information about China RoHS compliance, go to [ni.com/environment/rohs\\_china](http://ni.com/environment/rohs_china).)

# ExpressCard Serial Hardware

This section describes the characteristics of the ExpressCard serial hardware, along with the recommended operating conditions.

## NI ExpressCard-8420/2 (RS-232) and NI ExpressCard-8421/2 (RS-485/422)

Dimensions ..... 34 × 75 × 5 mm  
(1.34 × 2.95 × 0.2 in.)

Weight  
NI ExpressCard-8420/2 ..... 16 g (0.5 oz)  
NI ExpressCard-8421/2 ..... 17 g (0.6 oz)

Connectors  
I/O connector ..... 26-position latching connector with 20 cm breakout cable to two DB-9 male connectors  
ExpressCard ..... ExpressCard/34 standard connector interface

Power requirements  
(from ExpressCard USB interface)  
Voltage ..... +3.3 VDC ± 10%  
NI ExpressCard-8420/2  
+3.3 VDC ..... 100 mA typical



250 mA maximum

NI ExpressCard-8421/2

+3.3 VDC ..... 160 mA typical  
260 mA maximum

Shock and Vibration

Nonoperating shock ..... 50 g, 11 ms  
(Tested in accordance with IEC-60068-2-27.)

Nonoperating vibration,  
sinusoidal ..... 15 g, 100 to 2000 Hz  
(Tested in accordance with IEC-60068-2-6.)

Nonoperating drop test ..... 2 drops in 3 mutually exclusive axes from 75 cm  
onto no-cushioning vinyl tile surface

Environmental Characteristics

Altitude (maximum) ..... 2,000 m (at 25 °C ambient temperature)

Pollution Degree ..... 2

Indoor use only.

Operating Environment

Ambient temperature ..... 0 to 65 °C  
(Tested in accordance with IEC-60068-2-1 and  
IEC-60068-2-2.)

Relative humidity ..... 5 to 95%, noncondensing  
(Tested in accordance with IEC-60068-2-56.)



**Hot Surface** Be careful when removing ExpressCards. Recently used ExpressCards may exceed safe handling temperatures.

Storage Environment

Ambient temperature ..... -20 to 65 °C  
(Tested in accordance with IEC-60068-2-1 and  
IEC-60068-2-2.)

Nonoperating thermal shock ..... -20 to 65 °C, 5 shocks

Other Specifications

Maximum cable length

RS-485<sup>1</sup> ..... 30 m (limited by EMC/surge)

RS-232 ..... 2,500 pF equivalent (TIA-EIA-232-F 2.1.4)

Data line ESD protection (human body model)

RS-485 ..... ±15 kV

<sup>1</sup> RS-485 is capable of 1.2 km (4,000 ft) without surge limitation.

RS-232 ..... ±15 kV

#### Maximum baud rate

NI ExpressCard-8420/2 ..... 230.4 kbps

NI ExpressCard-8421/2 ..... 460.8 kbps

Boards support standard baud rates below the maximum.



**Note** This equipment is intended for indoor use only.

## Safety

This product meets the requirements of the following standards of safety for electrical equipment for measurement, control, and laboratory use:

- IEC 61010-1, EN 61010-1
- UL 61010-1, CSA 61010-1



**Note** For UL and other safety certifications, refer to the product label or the [Online Product Certification](#) section.

## Electromagnetic Compatibility

This product meets the requirements of the following EMC standards for electrical equipment for measurement, control, and laboratory use:

- EN 61326 (IEC 61326): Class A emissions; Basic immunity
- EN 55011 (CISPR 11): Group 1, Class A emissions
- AS/NZS CISPR 11: Group 1, Class A emissions
- FCC 47 CFR Part 15B: Class A emissions
- ICES-001: Class A emissions



**Note** For the standards applied to assess the EMC of this product, refer to the [Online Product Certification](#) section.



**Note** For EMC compliance, operate this device with shielded cabling.

## CE Compliance

This product meets the essential requirements of applicable European Directives as follows:

- 2006/95/EC; Low-Voltage Directive (safety)
- 2004/108/EC; Electromagnetic Compatibility Directive (EMC)

## Online Product Certification

Refer to the product Declaration of Conformity (DoC) for additional regulatory compliance information. To obtain product certifications and the DoC for this product, visit [ni.com/certification](http://ni.com/certification), search by model number or product line, and click the appropriate link in the Certification column.

## Environmental Management

NI is committed to designing and manufacturing products in an environmentally responsible manner. NI recognizes that eliminating certain hazardous substances from our products is beneficial to the environment and to NI customers.

For additional environmental information, refer to the *Minimize Our Environmental Impact* web page at [ni.com/environment](http://ni.com/environment). This page contains the environmental regulations and directives with which NI complies, as well as other environmental information not included in this document.

## Waste Electrical and Electronic Equipment (WEEE)



**EU Customers** At the end of the product life cycle, all products *must* be sent to a WEEE recycling center. For more information about WEEE recycling centers, National Instruments WEEE initiatives, and compliance with WEEE Directive 2002/96/EC on Waste and Electronic Equipment, visit [ni.com/environment/weee](http://ni.com/environment/weee).

## 电子信息产品污染控制管理办法（中国 RoHS）



**中国客户** National Instruments 符合中国电子信息产品中限制使用某些有害物质指令 (RoHS)。关于 National Instruments 中国 RoHS 合规性信息，请登录 [ni.com/environment/rohs\\_china](http://ni.com/environment/rohs_china)。(For information about China RoHS compliance, go to [ni.com/environment/rohs\\_china](http://ni.com/environment/rohs_china).)

## Where to Go for Support

The NI website is your complete resource for technical support. At [ni.com/support](http://ni.com/support) you have access to everything from troubleshooting and application development self-help resources to email and phone assistance from NI Application Engineers.

Visit [ni.com/services](http://ni.com/services) for NI Factory Installation Services, repairs, extended warranty, and other services.

Visit [ni.com/register](http://ni.com/register) to register your NI product. Product registration facilitates technical support and ensures that you receive important information updates from NI.

A Declaration of Conformity (DoC) is our claim of compliance with the Council of the European Communities using the manufacturer's declaration of conformity. This system affords the user protection for electromagnetic compatibility (EMC) and product safety. You can obtain the DoC for your product by visiting [ni.com/certification](http://ni.com/certification). If your product supports calibration, you can obtain the calibration certificate for your product at [ni.com/calibration](http://ni.com/calibration).

NI corporate headquarters is located at 11500 North Mopac Expressway, Austin, Texas, 78759-3504. NI also has offices located around the world. For telephone support in the United States, create your service request at [ni.com/support](http://ni.com/support) or dial 1 866 ASK MYNI (275 6964). For telephone support outside the United States, visit the Worldwide Offices section of [ni.com/niglobal](http://ni.com/niglobal) to access the branch office websites, which provide up-to-date contact information, support phone numbers, email addresses, and current events.

Refer to the *NI Trademarks and Logo Guidelines* at [ni.com/trademarks](http://ni.com/trademarks) for more information on NI trademarks. Other product and company names mentioned herein are trademarks or trade names of their respective companies. For patents covering NI products/technology, refer to the appropriate location: **Help»Patents** in your software, the `patents.txt` file on your media, or the *National Instruments Patents Notice* at [ni.com/patents](http://ni.com/patents). You can find information about end-user license agreements (EULAs) and third-party legal notices in the `readme` file for your NI product. Refer to the *Export Compliance Information* at [ni.com/legal/export-compliance](http://ni.com/legal/export-compliance) for the NI global trade compliance policy and how to obtain relevant HTS codes, ECCNs, and other import/export data. NI MAKES NO EXPRESS OR IMPLIED WARRANTIES AS TO THE ACCURACY OF THE INFORMATION CONTAINED HEREIN AND SHALL NOT BE LIABLE FOR ANY ERRORS. U.S. Government Customers: The data contained in this manual was developed at private expense and is subject to the applicable limited rights and restricted data rights as set forth in FAR 52.227-14, DFAR 252.227-7014, and DFAR 252.227-7015.

© 2010–2017 National Instruments. All rights reserved.