

COMPREHENSIVE SERVICES

We offer competitive repair and calibration services, as well as easily accessible documentation and free downloadable resources.

SELL YOUR SURPLUS

We buy new, used, decommissioned, and surplus parts from every NI series. We work out the best solution to suit your individual needs.

 Sell For Cash  Get Credit  Receive a Trade-In Deal

OBSOLETE NI HARDWARE IN STOCK & READY TO SHIP

We stock **New**, **New Surplus**, **Refurbished**, and **Reconditioned** NI Hardware.



Bridging the gap between the manufacturer and your legacy test system.

 1-800-915-6216

 www.apexwaves.com

 sales@apexwaves.com

All trademarks, brands, and brand names are the property of their respective owners.

Request a Quote

 **CLICK HERE**

NI-9927

GETTING STARTED GUIDE

NI 9421

8-Channel Sinking Digital Input Module

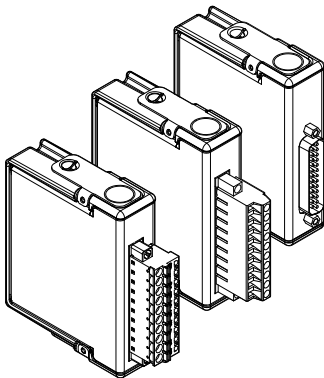

This document explains how to connect to the NI 9421. In this document, the NI 9421 with screw terminal, NI 9421 with spring terminal, and NI 9421 with DSUB are referred to inclusively as the NI 9421.



Note Before you begin, complete the software and hardware installation procedures in your chassis documentation.



Note The guidelines in this document are specific to the NI 9421. The other components in the system might not meet the same safety ratings. Refer to the documentation for each component in the system to determine the safety and EMC ratings for the entire system.

Safety Guidelines

Operate the NI 9421 only as described in this document.



Caution Do not operate the NI 9421 in a manner not specified in this document. Product misuse can result in a hazard. You can compromise the safety protection built into the product if the product is damaged in any

way. If the product is damaged, return it to NI for repair.

Safety Guidelines for Hazardous Voltages

If hazardous voltages are connected to the device, take the following precautions. A hazardous voltage is a voltage greater than 42.4 Vpk voltage or 60 VDC to earth ground.

You can connect hazardous voltages only to the NI 9421 with screw terminal and the NI 9421 with spring terminal. Do not connect hazardous voltages to the NI 9421 with DSUB.



Caution Ensure that hazardous voltage wiring is performed only by qualified personnel adhering to local electrical standards.



Caution Do not mix hazardous voltage circuits and human-accessible circuits on the same module.



Caution Ensure that devices and circuits connected to the module are properly insulated from human contact.



Caution When module terminals are hazardous voltage LIVE (>42.4 Vpk/60 VDC), you must ensure that devices and circuits connected to the module are

properly insulated from human contact. You must use the NI 9932 connector backshell kit to ensure that the terminals are not accessible.

NI 9421 with Screw/Spring Terminal Safety Voltages

Connect only voltages that are within the following limits:

Channel-to-COM.....30 V max

Isolation

Channel-to-channel.....None

Channel-to-earth ground

Continuous.....250 Vrms,
Measurement Category II

Withstand.....2,300 Vrms, verified by a
5 s dielectric withstand test

Measurement Category II is for measurements performed on circuits directly connected to the electrical distribution system. This category refers to local-level electrical distribution, such as that provided by a standard wall outlet, for example, 115 V for U.S. or 230 V for Europe.



Caution Do not connect the NI 9421 with screw terminal or NI 9421 with spring terminal to signals or use for measurements within Measurement Categories III or IV.

NI 9421 with DSUB Safety Voltages

Connect only voltages that are within the following limits:

Channel-to-COM.....30 V max

Isolation

Channel-to-channel.....None

Channel-to-earth ground

Continuous.....60 VDC,
Measurement Category I

Withstand.....1,000 Vrms, verified by a
5 s dielectric withstand test

Measurement Category I is for measurements performed on circuits not directly connected to the electrical distribution system referred to as *MAINS* voltage. *MAINS* is a hazardous live electrical supply system that powers equipment. This category is for measurements of voltages from specially protected secondary circuits. Such voltage measurements include signal levels, special

equipment, limited-energy parts of equipment, circuits powered by regulated low-voltage sources, and electronics.



Caution Do not connect the NI 9421 with DSUB to signals or use for measurements within Measurement Categories II, III, or IV.



Note Measurement Categories CAT I and CAT O are equivalent. These test and measurement circuits are not intended for direct connection to the MAINS building installations of Measurement Categories CAT II, CAT III, or CAT IV.

Safety Guidelines for Hazardous Locations

The NI 9421 is suitable for use in Class I, Division 2, Groups A, B, C, D, T4 hazardous locations; Class I, Zone 2, AEx nA IIC T4 and Ex nA IIC T4 hazardous locations; and nonhazardous locations only. Follow these guidelines if you are installing the NI 9421 in a potentially explosive environment. Not following these guidelines may result in serious injury or death.



Caution Do not disconnect I/O-side wires or connectors unless power has been switched off or the area is known to be nonhazardous.



Caution Do not remove modules unless power has been switched off or the area is known to be nonhazardous.



Caution Substitution of components may impair suitability for Class I, Division 2.



Caution For Division 2 and Zone 2 applications, install the system in an enclosure rated to at least IP54 as defined by IEC/EN 60079-15.



Caution For Division 2 and Zone 2 applications, connected signals must be within the following limits.

Capacitance.....0.2 μ F max

Special Conditions for Hazardous Locations Use in Europe and Internationally

The NI 9421 has been evaluated as Ex nA IIC T4 Gc equipment under DEMKO Certificate No. 03 ATEX 0324020X and is IECEx 14.0089X certified. Each NI 9421 is marked  II 3G and is suitable for use in Zone 2 hazardous locations, in ambient temperatures of $-40\text{ }^{\circ}\text{C} \leq T_a \leq 70\text{ }^{\circ}\text{C}$. If you are using the NI 9421 in Gas Group IIC hazardous locations, you must use the device in

an NI chassis that has been evaluated as Ex nC IIC T4, Ex IIC T4, Ex nA IIC T4, or Ex nL IIC T4 equipment.



Caution You must make sure that transient disturbances do not exceed 140% of the rated voltage.



Caution The system shall only be used in an area of not more than Pollution Degree 2, as defined in IEC 60664-1.



Caution The system shall be mounted in an ATEX/IECEX-certified enclosure with a minimum ingress protection rating of at least IP54 as defined in IEC/EN 60079-15.



Caution The enclosure must have a door or cover accessible only by the use of a tool.

Electromagnetic Compatibility Guidelines

This product was tested and complies with the regulatory requirements and limits for electromagnetic compatibility (EMC) stated in the product specifications. These requirements and limits provide reasonable protection against harmful interference

when the product is operated in the intended operational electromagnetic environment.

This product is intended for use in industrial locations. However, harmful interference may occur in some installations, when the product is connected to a peripheral device or test object, or if the product is used in residential or commercial areas. To minimize interference with radio and television reception and prevent unacceptable performance degradation, install and use this product in strict accordance with the instructions in the product documentation.

Furthermore, any changes or modifications to the product not expressly approved by National Instruments could void your authority to operate it under your local regulatory rules.

Special Conditions for Marine Applications

Some products are Lloyd's Register (LR) Type Approved for marine (shipboard) applications. To verify Lloyd's Register certification for a product, visit [ni.com/certification](https://www.ni.com/certification) and search for the LR certificate, or look for the Lloyd's Register mark on the product.



Caution In order to meet the EMC requirements for marine applications, install the product in a shielded enclosure with shielded and/or filtered power and input/output ports. In addition, take precautions when designing, selecting, and installing measurement probes and cables to ensure that the desired EMC performance is attained.

Preparing the Environment

Ensure that the environment in which you are using the NI 9421 meets the following specifications.

Operating temperature.....-40 °C to 70 °C
(IEC 60068-2-1, IEC 60068-2-2)

Operating humidity..... 10% RH to 90% RH,
(IEC 60068-2-78) noncondensing

Pollution Degree.....2

Maximum altitude.....2,000 m

Indoor use only.



Note Refer to the device datasheet on ni.com/manuals for complete specifications.

Connecting the NI 9421

The NI 9421 provides connections for eight digital input channels.

Figure 1. NI 9421 Pinout

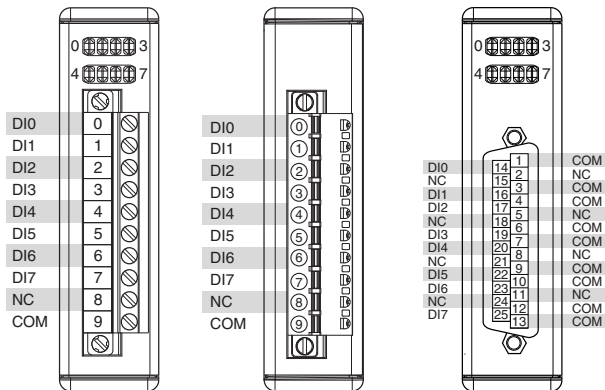

Note You must use 2-wire ferrules to create a secure connection when connecting more than one wire to a single terminal on the NI 9421 with screw terminal or NI 9421 with spring terminal.

NI 9421 Signals

Each channel of the NI 9421 has a DI terminal or pin to which you can connect voltage or current signals. The NI 9421 also has COM, a common terminal or pin that is internally connected to the isolated ground reference of the module.

The NI 9421 has sinking inputs, meaning that when the external device drives current or applies voltage to the DI terminal or pin, DI provides a path to COM for the current or voltage. The NI 9421 internally limits current signals connected to DI.

Connecting Sourcing-Output Devices

You can connect 2-, 3-, and 4-wire sourcing-output devices to the NI 9421. A sourcing-output device drives current or applies voltage to DI. An example of a sourcing-output device is an open collector PNP.

Connect the output of the sourcing-output device to DI on the NI 9421. Connect the common of the external device to the COM terminal or pin.

Figure 2. Connecting a Device to the NI 9421 (3-Wire Device Shown)

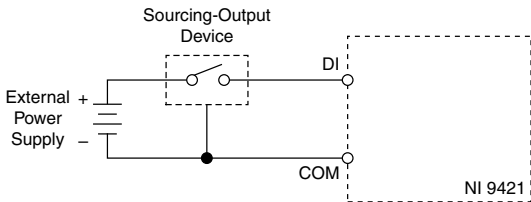

The NI 9421 channel registers as ON when the sourcing-output device applies a voltage or drives a current that is in the input ON range to DI. The channel registers as OFF when the device applies a voltage or drives a current that is in the input OFF range to DI. If no device is connected to DI, the channel registers as OFF.

LED Indications

Each channel has an LED that indicates the state of the channel, as the following table describes. The LEDs are disabled when the chassis is in sleep mode.

Table 1. LED Indications

LED State	Indication
Illuminated	Channel is on
Not illuminated	Channel is off

High-Vibration Application Connections

If your application is subject to high vibration, NI recommends that you follow these guidelines to protect connections to the NI 9421:

- Use ferrules to terminate wires to the detachable connector.
- Use the NI 9927 backshell kit with the NI 9421 with screw terminal or the NI 9981 backshell kit with the NI 9421 with spring terminal.

Where to Go Next

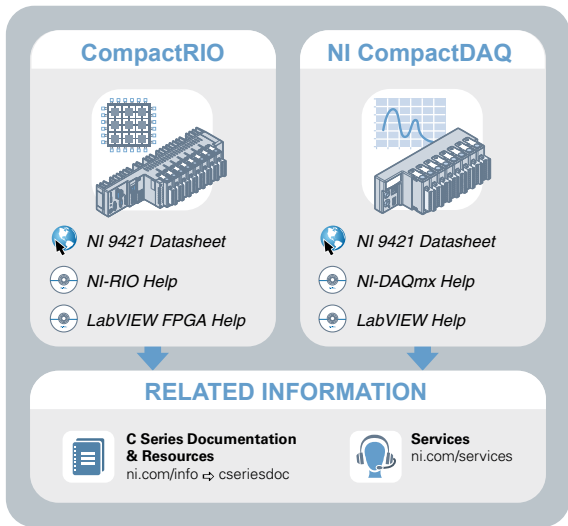

 Located at ni.com/manuals

 Installs with the software

Worldwide Support and Services

The National Instruments website is your complete resource for technical support. At ni.com/support, you have access to everything from troubleshooting and application development self-help resources to email and phone assistance from NI Application Engineers.

Visit ni.com/services for NI Factory Installation Services, repairs, extended warranty, and other services.

Visit ni.com/register to register your National Instruments product. Product registration facilitates technical support and ensures that you receive important information updates from NI.

A Declaration of Conformity (DoC) is our claim of compliance with the Council of the European Communities using the manufacturer's declaration of conformity. This system affords the user protection for electromagnetic compatibility (EMC) and product safety. You can obtain the DoC for your product by visiting ni.com/certification. If your product supports calibration, you can obtain the calibration certificate for your product at ni.com/calibration.

National Instruments corporate headquarters is located at 11500 North Mopac Expressway, Austin, Texas, 78759-3504. National Instruments also has offices located around the world. For telephone support in the United States, create your service request at ni.com/support or dial 1 866 ASK MYNI (275 6964). For telephone support outside the United States, visit the *Worldwide Offices* section of ni.com/niglobal to access the branch office websites, which provide up-to-date contact information, support phone numbers, email addresses, and current events.

Refer to the *NI Trademarks and Logo Guidelines* at ni.com/trademarks for information on National Instruments trademarks. Other product and company names mentioned herein are trademarks or trade names of their respective companies. For patents covering National Instruments products/technology, refer to the appropriate location: **Help»Patents** in your software, the `patents.txt` file on your media, or the *National Instruments Patent Notice* at ni.com/patents. You can find information about end-user license agreements (EULAs) and third-party legal notices in the readme file for your NI product. Refer to the *Export Compliance Information* at ni.com/legal/export-compliance for the National Instruments global trade compliance policy and how to obtain relevant HTS codes, ECCNs, and other import/export data. NI MAKES NO EXPRESS OR IMPLIED WARRANTIES AS TO THE ACCURACY OF THE INFORMATION CONTAINED HEREIN AND SHALL NOT BE LIABLE FOR ANY ERRORS. U.S. Government Customers: The data contained in this manual was developed at private expense and is subject to the applicable limited rights and restricted data rights as set forth in FAR 52.227-14, DFAR 252.227-7014, and DFAR 252.227-7015.

© 2003—2015 National Instruments. All rights reserved.

373504G-01 May15