

**GPIB**

# **Getting Started with Your PCI-GPIB or PCMCIA-GPIB and the GPIB Software for Windows NT**

January 1998 Edition  
Part Number 321289B-01

**Internet Support**

E-mail: [support@natinst.com](mailto:support@natinst.com)

FTP Site: <ftp.natinst.com>

Web Address: <http://www.natinst.com>

**Bulletin Board Support**

BBS United States: 512 794 5422

BBS United Kingdom: 01635 551422

BBS France: 01 48 65 15 59

**Fax-on-Demand Support**

512 418 1111

**Telephone Support (USA)**

Tel: 512 795 8248

Fax: 512 794 5678

**International Offices**

Australia 03 9879 5166, Austria 0662 45 79 90 0, Belgium 02 757 00 20, Brazil 011 288 3336,  
Canada (Ontario) 905 785 0085, Canada (Québec) 514 694 8521, Denmark 45 76 26 00,  
Finland 09 725 725 11, France 01 48 14 24 24, Germany 089 741 31 30, Hong Kong 2645 3186,  
Israel 03 6120092, Italy 02 413091, Japan 03 5472 2970, Korea 02 596 7456, Mexico 5 520 2635,  
Netherlands 0348 433466, Norway 32 84 84 00, Singapore 2265886, Spain 91 640 0085, Sweden 08 730 49 70,  
Switzerland 056 200 51 51, Taiwan 02 377 1200, United Kingdom 01635 523545

**National Instruments Corporate Headquarters**

6504 Bridge Point Parkway Austin, Texas 78730-5039 USA Tel: 512 794 0100

# Important Information

---

## Warranty

The GPIB hardware is warranted against defects in materials and workmanship for a period of two years from the date of shipment, as evidenced by receipts or other documentation. National Instruments will, at its option, repair or replace equipment that proves to be defective during the warranty period. This warranty includes parts and labor.

The media on which you receive National Instruments software are warranted not to fail to execute programming instructions, due to defects in materials and workmanship, for a period of 90 days from date of shipment, as evidenced by receipts or other documentation. National Instruments will, at its option, repair or replace software media that do not execute programming instructions if National Instruments receives notice of such defects during the warranty period. National Instruments does not warrant that the operation of the software shall be uninterrupted or error free.

A Return Material Authorization (RMA) number must be obtained from the factory and clearly marked on the outside of the package before any equipment will be accepted for warranty work. National Instruments will pay the shipping costs of returning to the owner parts which are covered by warranty.

National Instruments believes that the information in this manual is accurate. The document has been carefully reviewed for technical accuracy. In the event that technical or typographical errors exist, National Instruments reserves the right to make changes to subsequent editions of this document without prior notice to holders of this edition. The reader should consult National Instruments if errors are suspected. In no event shall National Instruments be liable for any damages arising out of or related to this document or the information contained in it.

EXCEPT AS SPECIFIED HEREIN, NATIONAL INSTRUMENTS MAKES NO WARRANTIES, EXPRESS OR IMPLIED, AND SPECIFICALLY DISCLAIMS ANY WARRANTY OF MERCHANTABILITY OR FITNESS FOR A PARTICULAR PURPOSE. CUSTOMER'S RIGHT TO RECOVER DAMAGES CAUSED BY FAULT OR NEGLIGENCE ON THE PART OF NATIONAL INSTRUMENTS SHALL BE LIMITED TO THE AMOUNT THEREOF PAID BY THE CUSTOMER. NATIONAL INSTRUMENTS WILL NOT BE LIABLE FOR DAMAGES RESULTING FROM LOSS OF DATA, PROFITS, USE OF PRODUCTS, OR INCIDENTAL OR CONSEQUENTIAL DAMAGES, EVEN IF ADVISED OF THE POSSIBILITY THEREOF. This limitation of the liability of National Instruments will apply regardless of the form of action, whether in contract or tort, including negligence. Any action against National Instruments must be brought within one year after the cause of action accrues. National Instruments shall not be liable for any delay in performance due to causes beyond its reasonable control. The warranty provided herein does not cover damages, defects, malfunctions, or service failures caused by owner's failure to follow the National Instruments installation, operation, or maintenance instructions; owner's modification of the product; owner's abuse, misuse, or negligent acts; and power failure or surges, fire, flood, accident, actions of third parties, or other events outside reasonable control.

## Copyright

Under the copyright laws, this publication may not be reproduced or transmitted in any form, electronic or mechanical, including photocopying, recording, storing in an information retrieval system, or translating, in whole or in part, without the prior written consent of National Instruments Corporation.

## Trademarks

CVI™, HS488™, LabVIEW™, NAT4882™, natinst.com™, NI-488™, NI-488.2™, NI-488.2M™, TNT 4882™C, and Turbo488™ are trademarks of National Instruments Corporation.

Product and company names listed are trademarks or trade names of their respective companies.

## WARNING REGARDING MEDICAL AND CLINICAL USE OF NATIONAL INSTRUMENTS PRODUCTS

National Instruments products are not designed with components and testing intended to ensure a level of reliability suitable for use in treatment and diagnosis of humans. Applications of National Instruments products involving medical or clinical treatment can create a potential for accidental injury caused by product failure, or by errors on the part of the user or application designer. Any use or application of National Instruments products for or involving medical or clinical treatment must be performed by properly trained and qualified medical personnel, and all traditional medical safeguards, equipment, and procedures that are appropriate in the particular situation to prevent serious injury or death should always continue to be used when National Instruments products are being used. National Instruments products are NOT intended to be a substitute for any form of established process, procedure, or equipment used to monitor or safeguard human health and safety in medical or clinical treatment.

# FCC/DOC Radio Frequency Interference Compliance

---

This equipment generates and uses radio frequency energy and, if not installed and used in strict accordance with the instructions in this manual, may cause interference to radio and television reception. Classification requirements are the same for the Federal Communications Commission (FCC) and the Canadian Department of Communications (DOC). The FCC/DOC classification is indicated on a label on the device. If an FCC ID is present, the equipment is Class B; otherwise, it is Class A. Look at the product to determine the classification, then read the appropriate information below regarding the compliance of your product:

## Class A

### Federal Communications Commission

This equipment has been tested and found to comply with the limits for a Class A digital device, pursuant to part 15 of the FCC Rules. These limits are designed to provide reasonable protection against harmful interference when the equipment is operated in a commercial environment. This equipment generates, uses, and can radiate radio frequency energy and, if not installed and used in accordance with the instruction manual, may cause harmful interference to radio communications. Operation of this equipment in a residential area is likely to cause harmful interference in which case the user will be required to correct the interference at his own expense.

### Canadian Department of Communications

This Class A digital apparatus meets all requirements of the Canadian Interference-Causing Equipment Regulations.

Cet appareil numérique de la classe A respecte toutes les exigences du Règlement sur le matériel brouilleur du Canada.

## Class B

### Federal Communications Commission

This equipment has been tested and found to comply with the limits for a Class B digital device, pursuant to part 15 of the FCC Rules. These limits are designed to provide reasonable protection against harmful interference in a residential installation. This equipment generates, uses and can radiate radio frequency energy and, if not installed and used in accordance with the instructions, may cause harmful interference to radio communications. However, there is no guarantee that interference will not occur in a particular installation. If this equipment does cause harmful interference to radio or television reception, which can be determined by turning the equipment off and on, the user is encouraged to try to correct the interference by one or more of the following measures:

- Reorient or relocate the receiving antenna.
- Increase the separation between the equipment and receiver.
- Connect the equipment into an outlet on a circuit different from that to which the receiver is connected.
- Consult the dealer or an experienced radio/TV technician for help.

### Canadian Department of Communications

This Class B digital apparatus meets all requirements of the Canadian Interference-Causing Equipment Regulations.

Cet appareil numérique de la classe B respecte toutes les exigences du Règlement sur le matériel brouilleur du Canada.

## **FCC Notices to User**

*Changes or modifications not expressly approved by National Instruments could void the user's authority to operate the equipment under the FCC Rules.*

*This device complies with the FCC rules only if used with shielded interface cables of suitable quality and construction. National Instruments used such cables to test this device and provides them for sale to the user. The use of inferior or nonshielded interface cables could void the user's authority to operate the equipment under the FCC rules.*

If necessary, consult National Instruments or an experienced radio/television technician for additional suggestions. The following booklet prepared by the FCC may also be helpful: Interference to Home Electronic Entertainment Equipment Handbook. This booklet is available from the U.S. Government Printing Office, Washington, DC 20402.

---

## About This Manual

How to Use the Manual Set .....	xi
Organization of This Manual .....	xii
Conventions Used in This Manual .....	xiii
Related Documentation .....	xiv
Customer Communication .....	xiv

## Chapter 1

### Introduction

How to Use This Manual .....	1-1
What You Need to Get Started .....	1-2
Optional Equipment .....	1-2
GPIB Hardware Overview .....	1-2
GPIB Software Overview .....	1-3
Time-Saving Development Tools .....	1-3

## Chapter 2

### Installation and Configuration

Install the Hardware .....	2-1
Install the PCI-GPIB .....	2-1
Install the PCMCIA-GPIB .....	2-3
Install the Software .....	2-4
Configure the Software .....	2-5
Configure the Software for Your PCI-GPIB or PCMCIA-GPIB .....	2-5
Configure the Software for Your PCI-GPIB .....	2-6
Configure the Software for Your PCMCIA-GPIB .....	2-7
Configure the GPIB Software Settings (Optional) .....	2-8

## Chapter 3

### Verify the Installation

## **Chapter 4**

### **Begin to Use the GPIB Software**

Getting Started with LabVIEW .....	4-1
Getting Started with LabWindows/CVI .....	4-1
Introduction to the Win32 Interactive Control Utility .....	4-2
Introduction to the NI Spy Utility .....	4-3
Running Existing GPIB Applications .....	4-3
General Programming Considerations .....	4-4

## **Appendix A**

### **Uninstalling the Hardware and Software**

## **Appendix B**

### **Troubleshooting and Common Questions**

## **Appendix C**

### **Specifications**

## **Appendix D**

### **Customer Communication**

## **Glossary**

## **Figures**

Figure 2-1.	Installing the PCI-GPIB .....	2-2
Figure 2-2.	Inserting the PCMCIA-GPIB .....	2-3
Figure 2-3.	GPIB Software for Windows NT Setup Dialog Box .....	2-4
Figure 2-4.	PCI-GPIB Configuration Dialog Box .....	2-6
Figure 2-5.	PCMCIA-GPIB Configuration Dialog Box .....	2-7
Figure 3-1.	Diagnostic Utility after Testing .....	3-1
Figure A-1.	Board Type Dialog Box .....	A-1
Figure A-2.	Add/Remove Programs Properties Dialog Box .....	A-2
Figure A-3.	Removed Shared Component Dialog Box .....	A-3

## Tables

Table C-1.	Hardware Characteristics for the PCI-GPIB .....	C-1
Table C-2.	Hardware Characteristics for the PCMCIA-GPIB .....	C-2
Table C-3.	GPIB Software Transfer Rates for the Plug and Play GPIB Hardware .....	C-2



*About  
This  
Manual*

This manual contains instructions for installing and configuring the National Instruments PCI-GPIB or PCMCIA-GPIB interface and the GPIB software for Windows NT. The GPIB software is intended for use with Windows NT version 4.0 or higher.

This manual assumes that you are already familiar with Windows NT.

## How to Use the Manual Set

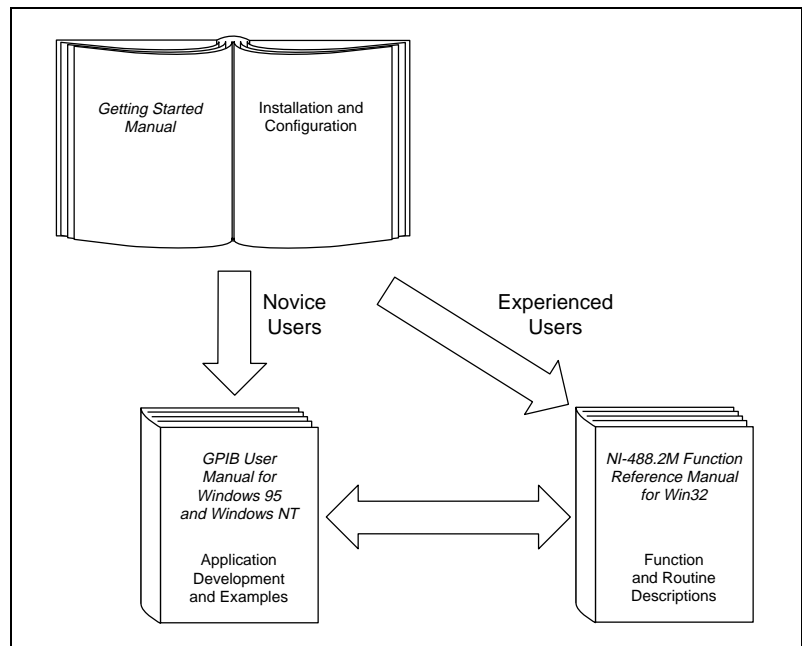

Use this getting started manual to install and configure your PCI-GPIB or PCMCIA-GPIB and the GPIB software for Windows NT.

Use the *GPIB User Manual for Windows 95 and Windows NT* to learn the basics of GPIB and how to develop an application program. This manual also contains application examples and troubleshooting information.

The *NI-488.2M Function Reference Manual for Win32* contains specific NI-488 function and NI-488.2 routine information, such as format, parameters, and possible errors.

## Organization of This Manual

---

The *Getting Started with Your PCI-GPIB or PCMCIA-GPIB and the GPIB Software for Windows NT* manual is organized as follows:

- Chapter 1, *Introduction*, explains how to use this manual, lists what you need to get started, and briefly describes the GPIB hardware and software.
- Chapter 2, *Installation and Configuration*, describes how to install and configure your PCI-GPIB or PCMCIA-GPIB and the GPIB software for Windows NT.
- Chapter 3, *Verify the Installation*, describes how to verify the hardware and software installation.
- Chapter 4, *Begin to Use the GPIB Software*, helps you get started with the GPIB software for Windows NT.
- Appendix A, *Uninstalling the Hardware and Software*, describes how to uninstall your PCI-GPIB or PCMCIA-GPIB and the GPIB software from Windows NT.
- Appendix B, *Troubleshooting and Common Questions*, describes how to troubleshoot problems and answers some common questions.
- Appendix C, *Specifications*, describes the electrical, physical, and environmental characteristics of the GPIB hardware and the recommended operating conditions.
- Appendix D, *Customer Communication*, contains forms you can use to request help from National Instruments or to comment on our products and manuals.
- The *Glossary* contains an alphabetical list and description of terms that appear in this manual, including abbreviations, acronyms, metric prefixes, mnemonics, and symbols.

# Conventions Used in This Manual

---

The following conventions are used in this manual:

»	The » symbol leads you through nested menu items and dialog box options to a final action. The sequence <b>File»Page Setup»Options»Substitute Fonts</b> directs you to pull down the <b>File</b> menu, select the <b>Page Setup</b> item, select <b>Options</b> , and finally select the <b>Substitute Fonts</b> options from the last dialog box.
	This icon to the left of bold italicized text denotes a caution, which advises you of precautions to take to avoid injury, data loss, or a system crash.
<b>bold</b>	Bold text denotes the names of menus, menu items, parameters, dialog boxes, dialog box buttons or options, icons, windows, Windows 95 tabs, or LEDs.
<b><i>bold italic</i></b>	Bold italic text denotes an activity objective, note, caution, or warning.
GPIB hardware	GPIB hardware refers generically to either the PCI-GPIB or PCMCIA-GPIB board when information can apply to either board.
IEEE 488 and IEEE 488.2	IEEE 488 and IEEE 488.2 refer to the ANSI/IEEE Standard 488.1-1987 and the ANSI/IEEE Standard 488.2-1992, respectively, which define the GPIB.
<i>italic</i>	Italic text denotes variables, emphasis, a cross reference, or an introduction to a key concept. This font also denotes text from which you supply the appropriate word or value, as in Windows 3.x.
monospace	Text in this font denotes text or characters that you should literally enter from the keyboard, sections of code, programming examples, and syntax examples. This font is also used for the proper names of disk drives, paths, directories, programs, subprograms, subroutines, device names, functions, operations, variables, filenames and extensions, and for statements and comments taken from programs.
<b>monospace bold</b>	Bold text in this font denotes the messages and responses that the computer automatically prints to the screen. This font also emphasizes lines of code that are different from the other examples.
<i>monospace italic</i>	Italic text in this font denotes that you must enter the appropriate words or values in the place of these items.

## Related Documentation

---

The following documents contain information that you may find helpful as you read this manual:

- ANSI/IEEE Standard 488.1-1987, *IEEE Standard Digital Interface for Programmable Instrumentation*
- ANSI/IEEE Standard 488.2-1992, *IEEE Standard Codes, Formats, Protocols, and Common Commands*
- *Microsoft Windows NT System Guide*, Microsoft Corporation

## Customer Communication

---

National Instruments wants to receive your comments on our products and manuals. We are interested in the applications you develop with our products, and we want to help if you have problems with them. To make it easy for you to contact us, this manual contains comment and configuration forms for you to complete. These forms are in Appendix D, [Customer Communication](#), at the end of this manual.

# Introduction

This chapter explains how to use this manual, lists what you need to get started, and briefly describes the GPIB hardware and software.

## How to Use This Manual

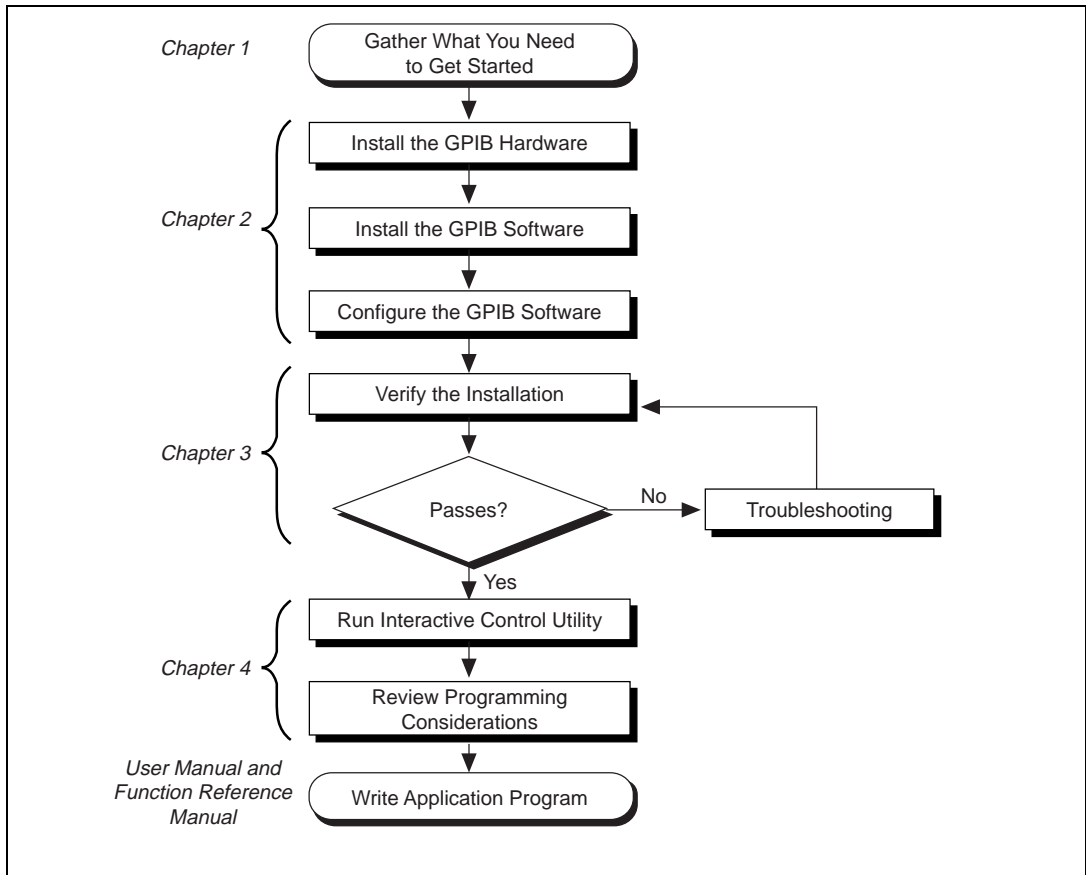

## What You Need to Get Started

---

Make sure you have all of the following items before you install your GPIB hardware and software for Windows NT:

- One of the following interfaces:
  - PCI-GPIB
  - PCMCIA-GPIB
- The following 3.5 in., high density (1.44 MB) disks, which your kit contains:
  - GPIB Software for Windows NT (Disk 1 of 2)*
  - GPIB Software for Windows NT (Disk 2 of 2)*
- Windows NT version 4.0 or higher installed on your system

## Optional Equipment

---

Call National Instruments for more information about the following optional equipment:

- Serial or parallel bus extender and cables
- Bus expander/isolator

## GPIB Hardware Overview

---

The Plug and Play GPIB hardware, along with the GPIB software, transforms any PC-compatible computer into a fully functional GPIB Talker/Listener/Controller that has complete communications and bus management capability. The TNT4882C chip on each Plug and Play GPIB board combines the circuitry of the NAT4882 ASIC, the Turbo488 ASIC, and GPIB transceivers to create a single-chip IEEE 488.2 interface. The TNT4882C also implements the HS488 high-speed protocol, which increases the maximum data transfer rate to up to 8 Mbytes/s, depending on the computer and the system configuration. For more information about transfer rates, refer to Appendix C, *Specifications*, in this manual. For more information about HS488, refer to Chapter 7, *GPIB Programming Techniques*, in the *GPIB User Manual for Windows 95 and Windows NT*.

The PCI-GPIB and PCMCIA-GPIB each contain one GPIB load; you can connect up to 14 instruments to one of these interfaces. If you want to use

more than the maximum number of instruments, you can order a bus extender or expander from National Instruments. Refer to Appendix C, *Specifications*, for more information about the hardware specifications and recommended operating conditions.

## GPIB Software Overview

---

The GPIB software for Windows NT includes a loadable Windows NT kernel device driver and supporting utilities.

The GPIB software includes the following components:

- Device driver
- Diagnostic test utility
- Configuration utility
- Interactive control program
- Utilities for software development and debugging
- Language interface libraries for Microsoft Visual C/C++ 2.0 or later, Borland C/C++ 4.0 or later, and Microsoft Visual Basic 4.0 or later
- Virtual device driver and special DOS and Windows 3 drivers for running existing NI-488.2 for DOS and Windows 3 applications under Windows NT
- Example programs that use NI-488 functions and NI-488.2 routines

For a detailed list of files, refer to Chapter 1, *Introduction*, in the *GPIB User Manual for Windows 95 and Windows NT*. Refer to Appendix C, *Specifications*, for information about the GPIB software transfer rates.

## Time-Saving Development Tools

---

Your kit includes the GPIB software for Windows NT. In addition, you can order the LabWindows/CVI or LabVIEW software from National Instruments to speed your application development time and make it easier to communicate with your instruments.

LabVIEW is an easy-to-use, graphical programming environment you can use to acquire data from thousands of different instruments, including IEEE 488.2 devices, VXI devices, serial devices, PLCs, and plug-in data acquisition boards. After you have acquired raw data, you can convert it into meaningful results using the powerful data analysis

routines in LabVIEW. LabVIEW also comes with hundreds of instrument drivers, which dramatically reduce software development time, because you do not have to spend time programming the low-level control of each instrument.

LabWindows/CVI is similar to LabVIEW, except that it combines an interactive, easy-to-use development approach with the programming power and flexibility of compiled ANSI C code.

For ordering information, or to request free demonstration software, contact National Instruments.



# Installation and Configuration

---

Chapter

2

This chapter describes how to install and configure your PCI-GPIB or PCMCIA-GPIB and the GPIB software for Windows NT.

## Install the Hardware

---

### Install the PCI-GPIB



**Caution**

*Electrostatic discharge can damage several components on your GPIB hardware. To avoid electrostatic damage when you handle the hardware, touch the antistatic plastic package to a metal part of your system chassis before you remove the hardware from the package.*

If your GPIB hardware is already installed, but this is your first time to install the GPIB software, skip to step 8. Otherwise, complete the following steps to install the PCI-GPIB:

1. Turn off your system. Keep the system plugged in so that it remains grounded while you install the PCI-GPIB.
2. Remove the top cover (or other access panels) to give yourself access to the computer expansion slots.
3. Find an unused expansion slot of the appropriate type in your computer.
4. Remove the corresponding slot cover on the back panel of the computer.

5. Insert the PCI-GPIB into the slot with the GPIB connector sticking out of the opening on the back panel, as shown in Figure 2-1. It might be a tight fit, but do not force the board into place.

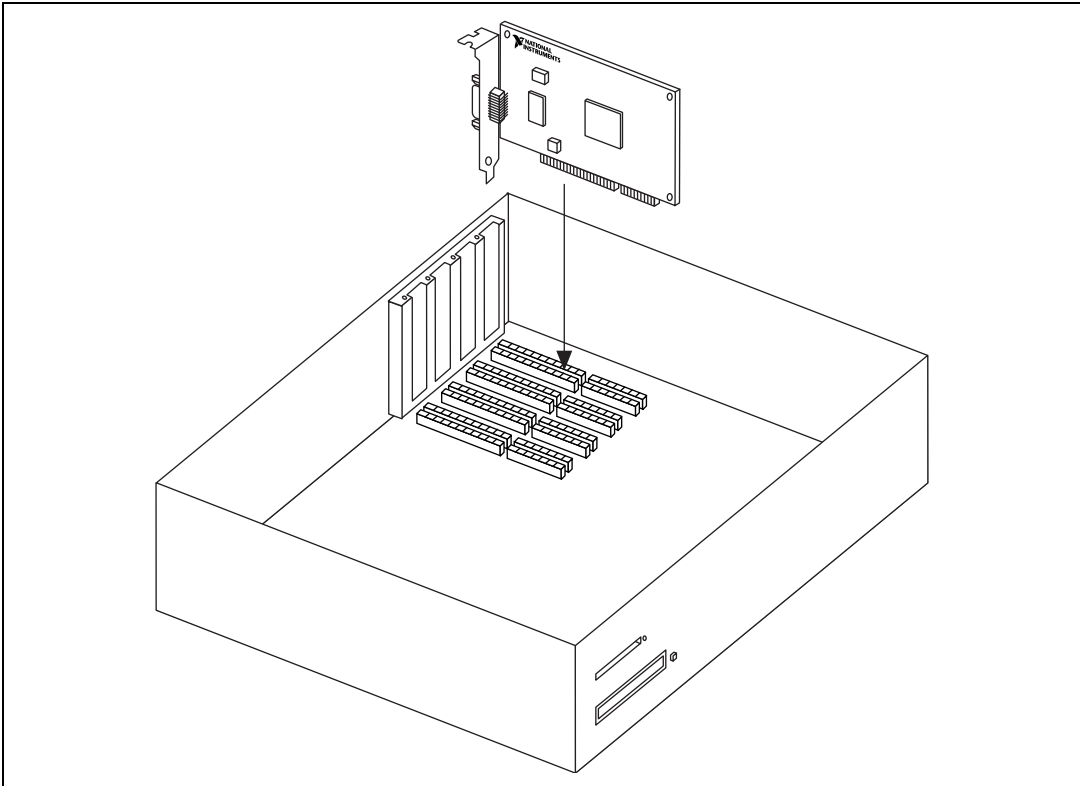

**Figure 2-1.** Installing the PCI-GPIB

6. Screw the mounting bracket of the PCI-GPIB to the back panel rail of the computer.
7. Replace the top cover (or the access panel to the expansion slot).
8. Turn on your system and start Windows NT.

The PCI-GPIB installation is now complete. Proceed to the [Install the Software](#) section later in this chapter.

## Install the PCMCIA-GPIB

Complete the following steps to install the PCMCIA-GPIB:

1. Turn off your system.
2. Insert the PCMCIA-GPIB card into a free PC Card (PCMCIA) socket the same way you insert a disk into a floppy drive, as shown in Figure 2-2. The card has no jumpers or switches to set.

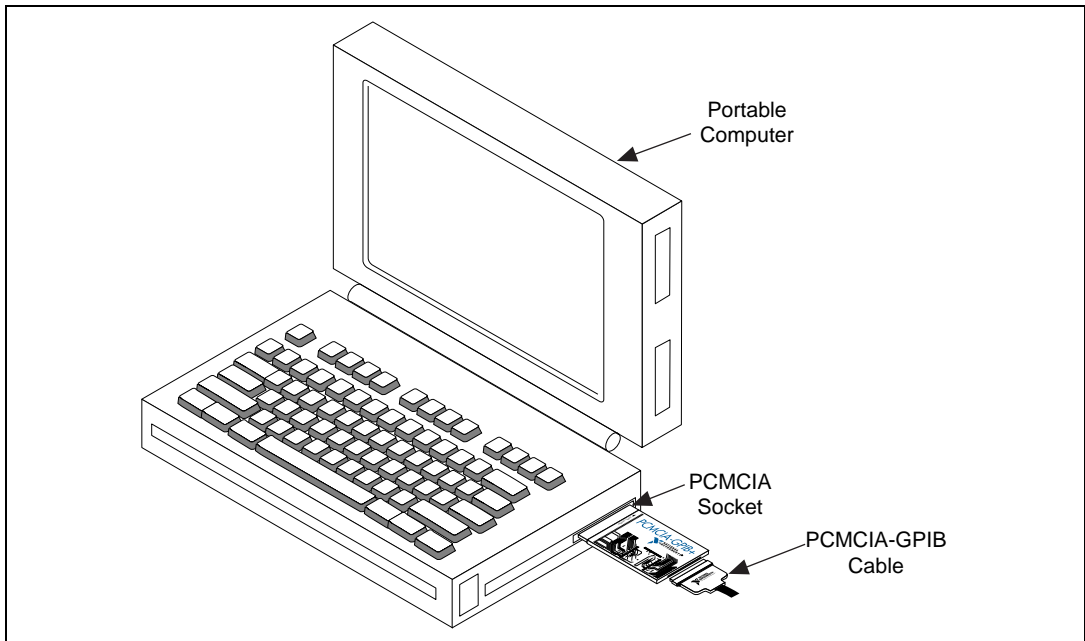

**Figure 2-2.** Inserting the PCMCIA-GPIB

3. Turn on your system and start Windows NT.

The PCMCIA-GPIB installation is now complete. Proceed to the next section, *Install the Software*.

## Install the Software

After you have installed and configured your GPIB hardware, complete the following steps to install the GPIB software for Windows NT:

1. Log onto your Windows NT system using the Administrator account. The GPIB setup program must have Administrator privileges because the program modifies the configuration registry of your system.
2. Insert the *GPIB Software for Windows NT (Disk 1 of 2)* into an unused drive.
3. Select **Run...** from the **Start** menu.
4. Type the following command in the dialog box:

```
x:\setup
```

where *x* is the letter of the drive containing the distribution disk (usually a or b).

The software installation begins with the dialog box shown in Figure 2-3.

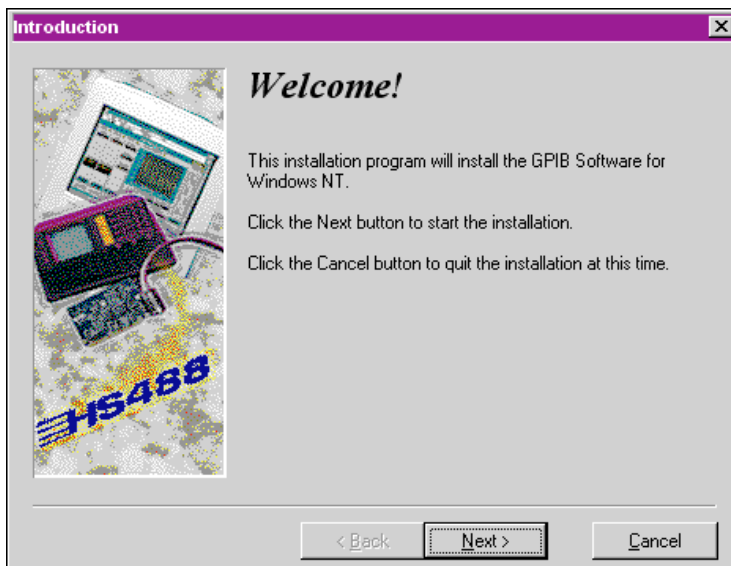

**Figure 2-3.** GPIB Software for Windows NT Setup Dialog Box

The setup wizard guides you through the necessary steps to install the GPIB software. To go back and change values where appropriate, click on the **Back** button. To exit the setup program at any time, click on the **Cancel** button.

Before you use the GPIB software with your PCI-GPIB or PCMCIA-GPIB, you must reconfigure the software. Refer to the next section, *Configure the Software*, for instructions on running the GPIB Configuration utility.

## Configure the Software

---

The GPIB Configuration utility is an interactive utility you can use to examine or modify the configuration of the GPIB driver. You must run the GPIB Configuration utility before you use the GPIB software for Windows NT.

### Configure the Software for Your PCI-GPIB or PCMCIA-GPIB

Complete the following steps to run the GPIB Configuration utility:

1. Select **Start»Settings»Control Panel** and double-click on the **GPIB** icon.  
The GPIB Configuration utility displays a list of all the GPIB boards and device names.
2. In the **GPIB Configuration** dialog box, select a GPIB interface from the **GPIB Board** list. If you are using only one GPIB interface, select **GPIB0**.
3. Click on the **Board Type** button and select **PCI-GPIB** or **PCMCIA-GPIB** from the list that appears. Click on the **OK** button.

## Configure the Software for Your PCI-GPIB

Complete the following steps to configure the GPIB software for your PCI-GPIB interface:

1. Click on the **Configure** button to bring up the **PCI-GPIB Configuration** dialog box, as shown in Figure 2-4.

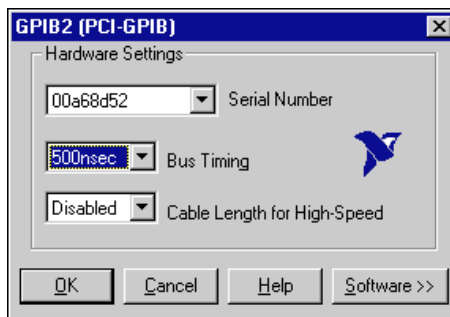

**Figure 2-4.** PCI-GPIB Configuration Dialog Box

2. In the **Serial Number** drop-down list, highlight the appropriate serial number.
3. Click on the **OK** button.
4. In the **GPIB Configuration** dialog box, click on the **OK** button to save your changes and exit the utility.
5. In the **Restart the GPIB Software?** dialog box, click on the **Yes** button.

## Configure the Software for Your PCMCIA-GPIB

Complete the following steps to configure the GPIB software for your PCMCIA-GPIB interface:

1. Click on the **Configure** button to bring up the **PCMCIA-GPIB Configuration** dialog box, as shown in Figure 2-4.

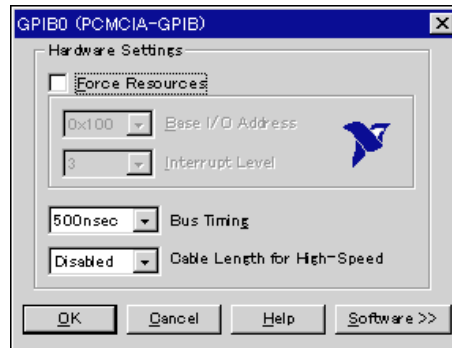

**Figure 2-5.** PCMCIA-GPIB Configuration Dialog Box

2. Resources are already assigned, but the resource assignments are not necessarily conflict-free. To force new resource assignments, check the **Force Resources** checkbox. For more information about resolving resource conflicts, refer to the [Resolving Resource Conflicts](#) section in Appendix B, [Troubleshooting and Common Questions](#).
3. Click on the **OK** button.
4. In the **GPIB Configuration** dialog box, click on the **OK** button to save your changes and exit the utility.
5. In the **Restart the GPIB Software?** dialog box, click on the **Yes** button.

To configure the GPIB software settings, continue to the [Configure the GPIB Software Settings \(Optional\)](#) section. Otherwise, continue to the next chapter, Chapter 3, [Verify the Installation](#).

## Configure the GPIB Software Settings (Optional)

Complete the following steps to configure the GPIB software settings:

1. Select **Start»Settings»Control Panel** and double-click on the **GPIB** icon.
2. You can configure additional items, such as the GPIB primary address or I/O timeout, but they are normally configured at run time by your application program. To examine or edit a setting, double-click on its name. For more information about GPIB Configuration utility options, refer to the *GPIB User Manual for Windows 95 and Windows NT* or use the online help.
3. To save your changes and exit the utility, click on the **OK** button. To discard the changes and exit the utility, click on the **Cancel** button.

After you install and configure the software, you should verify the installation. Continue to the next chapter, Chapter 3, [Verify the Installation](#).



# Verify the Installation

## Chapter 3

This chapter describes how to verify the hardware and software installation.

You can use the Diagnostic utility, installed with your GPIB software, to test the hardware and software installation. The Diagnostic utility verifies that your hardware and software are functioning properly and that the configuration of your GPIB interfaces does not conflict with anything else in your system.

To run the Diagnostic utility, select the **Diagnostic** item under **Start»Programs»GPIB Software**.

After you start the Diagnostic utility, test your GPIB interfaces by clicking on the **Test All** button. If the Diagnostic utility test is successful, it puts a checkmark next to the interface and changes its status from **untested** to **passed**. If the Diagnostic utility test fails, it puts an X next to the interface, and changes its status from **untested** to **failed**. Figure 3-1 shows the **Diagnostic** dialog box after it has tested some GPIB interfaces.

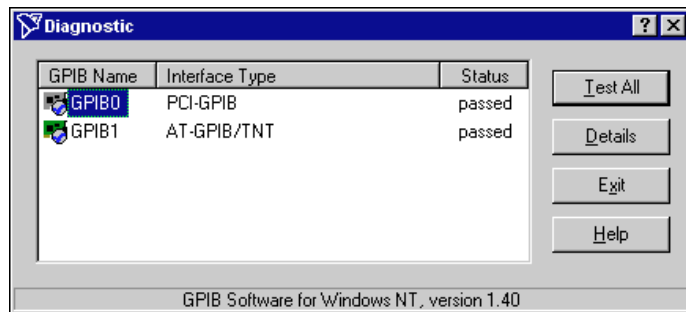
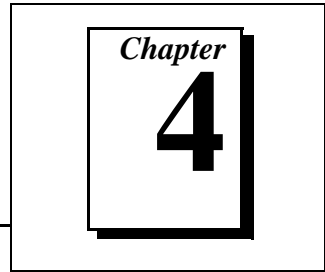

**Figure 3-1.** Diagnostic Utility after Testing

To get details on any of the tested GPIB interfaces, select the interface and click on the **Details** button. For each failed GPIB interface, select it and click on the **Details** button to get a description of the failure. Use that information and the information in Appendix B, *Troubleshooting and Common Questions*, to troubleshoot the problem. Troubleshooting information is also available in the Diagnostic utility online help, which you can access by clicking on the **Help** button.

# Begin to Use the GPIB Software

---



This chapter helps you get started with the GPIB software for Windows NT.

## Getting Started with LabVIEW

---

LabVIEW is a graphical programming language in which your source code looks like a flowchart. It provides the same functionality as other programming languages when controlling GPIB instruments. If you already installed LabVIEW, you can use the LabVIEW GPIB functions without any additional installation. To learn about the basic concepts of GPIB communication, refer to the LabVIEW GPIB functions chapter in the *LabVIEW User Manual*. To learn more about each GPIB function, refer to the *LabVIEW Function and VI Overview Manual* and the online help.

National Instruments provides LabVIEW instrument drivers, which are applications that communicate to a specific GPIB instrument. LabVIEW instrument drivers eliminate the need to learn the complex, low-level programming commands for each instrument. For more information, refer to Chapter 7, *Getting Started with a LabVIEW Instrument Driver*, in the *LabVIEW User Manual*. If you want to write your own instrument driver, National Instruments provides application notes that help you get started.

To find GPIB examples similar to your application, click on the **Solution Wizard** and **Search Examples** buttons in the startup LabVIEW dialog box.

For more information about NI products, refer to our web site at <http://www.natinst.com/products/>.

## Getting Started with LabWindows/CVI

---

If you already installed LabWindows/CVI, you can use the LabWindows/CVI GPIB Library without any additional installation. The LabWindows/CVI GPIB Library includes the functions documented in your NI-488.2 or NI-488.2M reference manual, as well as several additional functions, which are documented in the GPIB library chapter of

the *LabWindows/CVI Standard Libraries Reference Manual*. To help you use the GPIB functions, LabWindows/CVI provides function panels for the GPIB Library. To access the function panels, select **GPIB/GPIB 488.2** from the **Library** menu of the **Project** or **Source** windows. For information about using function panels, refer to the function panels chapter in the *LabWindows/CVI User Manual*.

If you need to program a GPIB instrument, you might want to use an instrument driver. An instrument driver is a set of high-level C functions for controlling a specific instrument. The low-level steps to control the instrument and read data are encapsulated in the high-level functions. You can write an instrument driver yourself, or you can use one that is already written. When you purchase LabWindows/CVI, you get free access to a library of drivers for hundreds of instruments. For more information about instrument drivers, refer to the project window chapter in the *LabWindows/CVI User Manual*.

For more information about NI products, please refer to our web site at <http://www.natinst.com/products/>.

## Introduction to the Win32 Interactive Control Utility

---

You can use the interactive control utility to enter NI-488 functions and NI-488.2 routines interactively and see the values returned by the function calls. You can use this utility to do the following:

- Verify GPIB communication with your device quickly and easily.
- Learn the NI-488 functions and NI-488.2 routines before you write your application.
- Become familiar with the commands of your device.
- Receive data from your GPIB device.
- Troubleshoot problems with your application.

To run the Win32 Interactive Control utility, select the **Win32 Interactive Control** item under **Start»Programs»GPIB Software**.

This utility includes extensive online help, which you can access by entering `help` at the `:` prompt. For more information about the Win32 Interactive Control utility, refer to the *GPIB User Manual for Windows 95 and Windows NT*.

## Introduction to the NI Spy Utility

---

Included with the GPIB software is NI Spy, a Win32 utility that monitors and records multiple National Instruments APIs (for example, NI-488.2 and VISA). You can use NI Spy to monitor Win32, Win16, and DOS GPIB applications. Use NI Spy to do the following:

- Capture information about NI-488 functions and NI-488.2 routines as your GPIB applications invoke them.
- Display captured information, including, but not limited to, input and output parameter values, I/O buffer contents, and return values.
- Save, restore, and print captured information.

To run NI Spy, select the **NI Spy** item under **Start»Programs»GPIB Software**.

For more information about the NI Spy utility, refer to Chapter 5, *NI Spy Utility*, in the *GPIB User Manual for Windows 95 and Windows NT*, or use its built-in, context-sensitive online help.

## Running Existing GPIB Applications

---

You can run existing Win32, Win16, and DOS GPIB applications under Windows NT.

Win32 and Win16 GPIB applications run without any special modifications. To run an existing DOS GPIB application, complete the following steps.

Load the special GPIB device driver `gpib-nt.com` instead of `gpib.com`, which you normally use with DOS. When you install the GPIB software, the GPIB setup program copies `gpib-nt.com` into a new subdirectory called `doswin16`. To use `gpib-nt.com`, you must modify your `config.nt` file to load `gpib-nt.com` whenever a DOS application runs. The `config.nt` file is located in your `winnt\system32` directory, where `winnt` is your Windows NT directory, for example, `c:\windows`. The GPIB setup program modifies the `config.nt` file by adding the following lines:

```
REM *** To run DOS GPIB applications, uncomment the
REM *** following line
REM device=path\doswin16\gpib-nt.com
```

where *path* is the directory in which you installed the GPIB software.

To load `gpib-nt.com`, locate these lines in your `config.nt` file and delete `REM` from the third line, as follows:

```
REM *** To run DOS GPIB applications, uncomment the
REM *** following line
device=path\doswin16\gpib-nt.com
```

where *path* is the directory in which you installed the GPIB software.

## General Programming Considerations

---

As you begin developing your Win32 GPIB application, remember the following points:

- For your C/C++ application, you must include the NI-488.2M header file, `decl-32.h`, in your source code.
- You can access the GPIB software through the 32-bit DLL, `gpib-32.dll`, either by linking with one of the language interfaces provided with the GPIB software, or by using direct DLL entry from other programming environments.
- Several sample GPIB applications are included with the GPIB software. Use these as a guide for your own application development.

For information about choosing a programming method, developing your application, or compiling and linking, refer to the *GPIB User Manual for Windows 95 and Windows NT*. For detailed information about each NI-488 function and NI-488.2 routine, refer to the *NI-488.2M Function Reference Manual for Win32* or the online help.

# Uninstalling the Hardware and Software

---

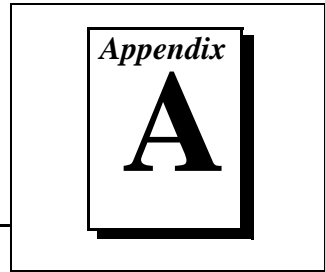

This appendix describes how to uninstall your PCI-GPIB or PCMCIA-GPIB and the GPIB software from Windows NT.

## Uninstalling the Hardware

---

Before you physically remove the GPIB hardware from your system, you must remove the hardware information using the GPIB Configuration utility. Complete the following steps to remove the hardware information:

1. Select **Start»Settings»Control Panel** and double-click on the **GPIB** icon.
2. In the **GPIB Configuration** dialog box, select the GPIB interface you want to remove from the **GPIB Board** list.
3. Click on the **Board Type** button and select **None** from the list that appears, as shown in Figure A-1. Click on the **OK** button to save the new **Board Type** setting.

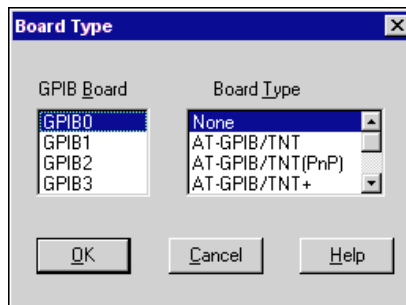

**Figure A-1.** Board Type Dialog Box

4. Click on the **OK** button to save your changes and exit the GPIB Configuration utility.
5. Shut down Windows NT, turn off your system, and physically remove the interface from your system.

## Uninstalling the Software

Before you uninstall the GPIB software, you should set the **Board Type** for your GPIB interface(s) to **None** in the GPIB Configuration utility, as described in the previous section. Complete the following steps to uninstall the GPIB software:

1. Select **Start»Settings»Control Panel** and double-click on the **Add/Remove Programs** icon. The dialog box shown in Figure A-2 lists the software available for removal.

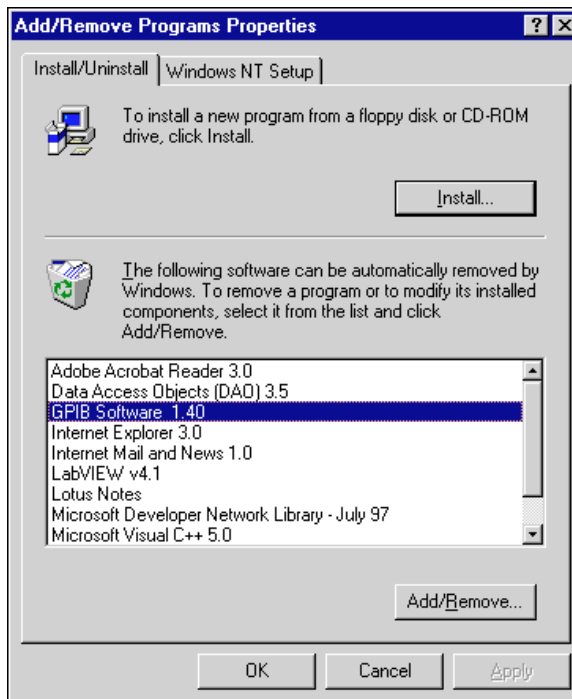

**Figure A-2.** Add/Remove Programs Properties Dialog Box



2. Select the GPIB software you want to remove and click on the **Add/Remove...** button. The uninstall program removes all folders, programs, DLLs, and registry entries associated with the GPIB software. During uninstallation, you are prompted about deleting shared components, as shown in Figure A-3. Click on **Yes**, **No**, or **No to All** to continue with the uninstallation.

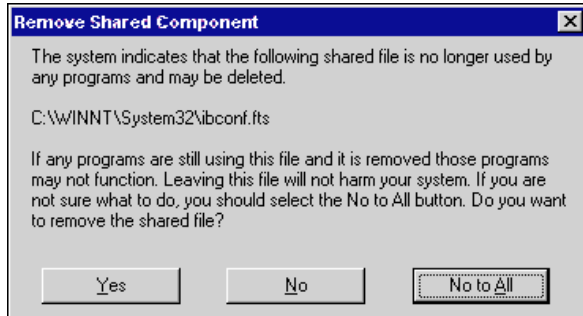

**Figure A-3.** Removed Shared Component Dialog Box

If you have not physically removed your hardware, shut down Windows NT, turn off your system, and remove the GPIB hardware.

The uninstall program removes only items that the GPIB setup program installed. If you add anything to a directory created by the GPIB setup program, the uninstall program does not delete that directory. You need to remove any remaining components yourself.

If you want to reinstall the GPIB hardware and software, refer to Chapter 2, *Installation and Configuration*.

# Troubleshooting and Common Questions

---

A graphic consisting of a large, bold, black letter 'B' centered within a white square. The square is enclosed in a thick black border. Above the 'B', the word 'Appendix' is written in a smaller, italicized font.

This appendix describes how to troubleshoot problems and answers some common questions.

## Troubleshooting Diagnostic Utility Failures

---

The following sections explain common error messages generated by the Diagnostic utility.

### Missing Software Components

This error occurs if the software components that are necessary for the GPIB software for Windows NT to function correctly are not present in the system. If you encounter this problem, reinstall the GPIB Software for Windows NT and run the Diagnostic utility again.

### No GPIB Interfaces Present

This error occurs if there are no GPIB interfaces physically present in the system or there is a resource conflict with the interfaces that are installed. If you encounter this problem, use the GPIB Configuration utility to examine the installed GPIB interfaces and the resources assigned to each. Then, run the Diagnostic utility again.

To access this information in the GPIB Configuration utility, complete the following steps:

1. Select **Start»Settings»Control Panel** and double-click on the **GPIB** icon.
2. Click on the **Board Type** button and verify that the type of GPIB interface listed for each logical board name is correct. Click on the **OK** button to return to the main dialog box.
3. Double-click on each board name and verify that the hardware settings displayed in the dialog box match your actual hardware settings.

## GPIB Cables Need To Be Disconnected

This error occurs if you have any GPIB cables connected to the GPIB interface. Disconnect all GPIB cables and run the Diagnostic utility again.

## Address Resource Conflict

This error occurs if the address resources assigned to a GPIB interface conflict with the address resources being used by other devices in the system. To resolve an address resource conflict, refer to the [Resolving Resource Conflicts](#) section later in this appendix. After you have resolved the conflict, run the Diagnostic utility again.

## Interrupt Resource Conflict

This error occurs if the interrupt resources assigned to a GPIB interface conflict with the interrupt resources being used by other devices in the system. To resolve an interrupt resource conflict, refer to the [Resolving Resource Conflicts](#) section later in this appendix. After you have resolved the conflict, run the Diagnostic utility again.

## GPIB Software Problem Encountered

This error occurs if the Diagnostic utility detects that it is unable to communicate correctly with the GPIB hardware using the installed GPIB software. If you encounter this error, shut down your system, restart it, and run the Diagnostic utility again. If the problem persists, reinstall the GPIB software for Windows NT.

## Unknown Problem Encountered

This error occurs if an unknown problem is encountered when you try to execute the Diagnostic utility. If this error occurs, shut down your system, restart it, and run the Diagnostic utility again. If the problem persists, reinstall the GPIB software for Windows NT.

## Resolving Resource Conflicts

---

Resource conflicts occur when your system contains hardware that is configured to use the same resources as your GPIB interface. The GPIB driver detects some resource conflicts when it loads. When the driver detects conflicts as it loads, it records an error message describing the conflict. You can use the Event Viewer, as described in the following section, [Using Windows NT Diagnostic Tools](#), to see which resource is in conflict.

Once you have identified the resource that caused the conflict, use the GPIB Configuration utility to reconfigure your GPIB interface so that it uses conflict-free resources. To help in the selection of conflict-free resources, Microsoft has provided a utility called Windows NT Diagnostics. This utility displays a list of the I/O port addresses, interrupt levels, and DMA channels that your system is currently using. You can assign resources not listed by this utility to your GPIB interface.

To run the Windows NT Diagnostics utility, select **Start»Programs»Administrative Tools»Windows NT Diagnostics**.

## Using Windows NT Diagnostic Tools

---

There are many reasons why the GPIB driver might not load. If the software is not properly installed or if there is a conflict between the GPIB hardware and the other hardware in the system, the GPIB driver fails to start. Two Windows NT utilities are useful in determining the source of the problem: the Devices applet in the Control Panel, and the Event Viewer. The following sections describe the information available through each utility.

### Examining NT Devices To Verify the GPIB Installation

To verify whether the GPIB devices are installed correctly (that is, that the devices are started), select **Start»Settings»Control Panel** and double-click on the **Devices** icon.

This utility lists all of the devices detected by Windows NT. Each device has a status associated with it. If the GPIB driver is installed correctly, the following lines appear in the list of Windows NT devices:

<u>Device</u>	<u>Status</u>	<u>Started</u>
GPIB Board Class Driver	Started	Automatic
GPIB Device Class Driver	Started	Automatic

You should also see one or more lines similar to the following:

<u>Device</u>	<u>Status</u>	<u>Started</u>
GPIB Port Driver (AT-GPIB)	****	System
GPIB Port Driver (PCI-GPIB)	****	System

The GPIB Board Class Driver, the GPIB Device Class Driver, and at least one of the GPIB Port Drivers listed by the Devices applet should have a status of **started**. If not, refer to the next section, *Examining the NT System Log Using the Event Viewer*.

If the GPIB Class Driver lines are not present or at least one GPIB Port Driver line is not present, the GPIB software is not installed properly. You should reinstall the GPIB software. Refer to Chapter 2, *Installation and Configuration*, for installation instructions.

## Examining the NT System Log Using the Event Viewer

Windows NT maintains a system log. If the GPIB driver is unable to start, it records entries in the system log explaining why it failed to start. To examine the system log by running the Event Viewer utility, select **Start»Programs»Administrative Tools»Event Viewer**.

Events that might appear in the system log include the following:

- The system cannot locate the device file for one or more of the devices that make up the GPIB driver and an event is logged that **The system cannot find the file specified**. In this case, the GPIB software is not installed properly. You should reinstall the GPIB software. Refer to Chapter 2, *Installation and Configuration*, for installation instructions.
- A conflict exists between the GPIB hardware and the other hardware in the system. If this is the case, an event is logged that indicates the nature of the resource conflict. To correct this conflict, reconfigure the GPIB hardware and the GPIB software. Refer to Chapter 2, *Installation and Configuration*, for configuration information.

## Common Questions

---

### **How can I determine which type of GPIB hardware I have installed?**

Run the GPIB Configuration utility: select **Start»Settings»Control Panel** and double-click on the **GPIB** icon.

### **How can I determine which version of the GPIB software I have installed?**

Run the Diagnostic utility: select the **Diagnostic** item under **Start»Programs»GPIB Software**. The Diagnostic utility displays the version of the GPIB software that is installed in a banner at the bottom of the window that appears.

**Which GPIB interfaces does version 1.4 of the GPIB software for Windows NT support?**

Version 1.4 of the GPIB software for Windows NT supports the AT-GPIB, AT-GPIB/TNT, AT-GPIB/TNT (PnP), AT-GPIB/TNT+, PCI-GPIB, PCI-GPIB+, PCMCIA-GPIB, PMC-GPIB, PXI-GPIB, and PC/104-GPIB.

**How many GPIB interfaces can I configure for use with my GPIB software for Windows NT?**

You can configure the GPIB software for Windows NT to communicate with up to four GPIB interfaces.

**How many devices can I configure for use with my GPIB software for Windows NT?**

The GPIB software for Windows NT provides a total of 100 logical devices for applications to use. The default number of devices is 32.

**Are interrupts and DMA required with the GPIB software for Windows NT?**

Interrupts are required, but DMA is not.

**How can I determine if my GPIB hardware and software are installed properly?**

Run the Diagnostic utility: select the **Diagnostic** item under **Start»Programs»GPIB Software**. Refer to the [Troubleshooting Diagnostic Utility Failures](#) section earlier in this appendix or the online help to troubleshoot any problems.

**When should I use the Win32 Interactive Control utility?**

You can use the Win32 Interactive Control utility to test and verify instrument communication, troubleshoot problems, and develop your application. For more information, refer to the [Introduction to the Win32 Interactive Control Utility](#) section in Chapter 4, [Begin to Use the GPIB Software](#).

**How do I use an NI-488.2M language interface?**

For information about using NI-488.2M language interfaces, refer to Chapter 3, [Developing Your Application](#), in the [GPIB User Manual for Windows 95 and Windows NT](#).

### **What do I do if the Diagnostic utility fails with an error?**

Use the Diagnostic utility online help, or refer to the *Troubleshooting Diagnostic Utility Failures* section earlier in this appendix. If you have already completed the troubleshooting steps, fill out the forms in Appendix D, *Customer Communication*, and contact National Instruments.

### **How do I communicate with my instrument over the GPIB?**

Refer to the documentation that came from the instrument manufacturer. The command sequences you use are totally dependent on the specific instrument. The documentation for each instrument should include the GPIB commands you need to communicate with it. In most cases, NI-488 device-level calls are sufficient for communicating with instruments. Refer to Chapter 3, *Developing Your Application*, in the *GPIB User Manual for Windows 95 and Windows NT*, for more information.

### **Can I use the NI-488 and NI-488.2 calls together in the same application?**

Yes, you can mix NI-488 functions and NI-488.2 routines.

### **What can I do to check for errors in my GPIB application?**

Examine the value of `ibsta` after each NI-488 or NI-488.2 call. If a call fails, the ERR bit of `ibsta` is set and an error code is stored in `iberr`. For more information about global status variables, refer to Chapter 3, *Developing Your Application*, in the *GPIB User Manual for Windows 95 and Windows NT*.

### **What information should I have before I call National Instruments?**

When you call National Instruments, you should have the results of the Diagnostic utility test. Also, make sure you have filled out the forms in Appendix D, *Customer Communication*.

# Specifications

---

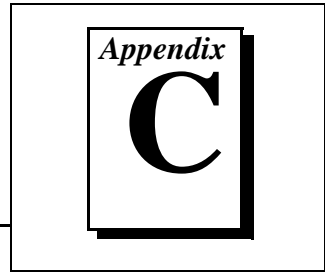

This appendix describes the electrical, physical, and environmental characteristics of the GPIB hardware and the recommended operating conditions.

## Hardware Characteristics

---

**Table C-1.** Hardware Characteristics for the PCI-GPIB

<b>Characteristic</b>	<b>Specification</b>
Dimensions	10.67 by 16.51 cm (14.2 by 6.5 in.)
Power Requirement (from PCI bus)	+5 VDC 300 mA Typical 450 mA Maximum
I/O Connector	IEEE 488 Standard 24-Pin
Operating Environment: Component Temperature Relative Humidity	0° to 55° C 10% to 90%, noncondensing
Storage Environment: Temperature Relative Humidity	-20° to 70° C 5% to 90%, noncondensing
EMI	FCC Class B Certified



**Table C-2.** Hardware Characteristics for the PCMCIA-GPIB

Characteristic	Specification
Dimensions	85.6 by 54.0 by 5.0 mm (3.370 by 2.126 by 0.197 in.)
Power Requirement (from PCMCIA expansion slot)	+5 VDC    50 mA    Typical 120 mA    Maximum
I/O Connector	Special IEEE 488 Cable with 24-Pin Converter for PC Card
Operating Environment: Component Temperature Relative Humidity	0° to 55° C 10% to 90%, noncondensing
Storage Environment: Temperature Relative Humidity	-20° to 70° C 5% to 90%, noncondensing
EMI	FCC Class A Certified

## Software Transfer Rates

**Table C-3.** GPIB Software Transfer Rates for the Plug and Play GPIB Hardware

GPIB Hardware	Transfer Method	Maximum GPIB Transfer Rate
PCI-GPIB	3-wire (IEEE 488)	1.2 Mbytes/s*
	High Speed (HS488)	7.8 Mbytes/s*
PCMCIA-GPIB	3-Wire (IEEE 488)	1.4 MB/s*
	High Speed (HS488)	1.7 MB/s*
* Actual speed may vary considerably from speed shown because of system and instrumentation capabilities.		

# Customer Communication

---

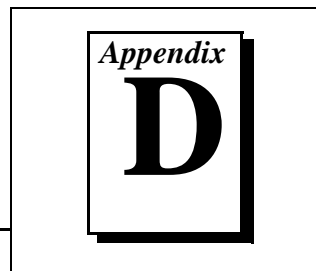

For your convenience, this appendix contains forms to help you gather the information necessary to help us solve your technical problems and a form you can use to comment on the product documentation. When you contact us, we need the information on the Technical Support Form and the configuration form, if your manual contains one, about your system configuration to answer your questions as quickly as possible.

National Instruments has technical assistance through electronic, fax, and telephone systems to quickly provide the information you need. Our electronic services include a bulletin board service, an FTP site, a fax-on-demand system, and e-mail support. If you have a hardware or software problem, first try the electronic support systems. If the information available on these systems does not answer your questions, we offer fax and telephone support through our technical support centers, which are staffed by applications engineers.

## Electronic Services

### Bulletin Board Support

National Instruments has BBS and FTP sites dedicated for 24-hour support with a collection of files and documents to answer most common customer questions. From these sites, you can also download the latest instrument drivers, updates, and example programs. For recorded instructions on how to use the bulletin board and FTP services and for BBS automated information, call 512 795 6990. You can access these services at:

United States: 512 794 5422

Up to 14,400 baud, 8 data bits, 1 stop bit, no parity

United Kingdom: 01635 551422

Up to 9,600 baud, 8 data bits, 1 stop bit, no parity

France: 01 48 65 15 59

Up to 9,600 baud, 8 data bits, 1 stop bit, no parity

### FTP Support

To access our FTP site, log on to our Internet host, `ftp.natinst.com`, as anonymous and use your Internet address, such as `joesmith@anywhere.com`, as your password. The support files and documents are located in the `/support` directories.

## Fax-on-Demand Support

Fax-on-Demand is a 24-hour information retrieval system containing a library of documents on a wide range of technical information. You can access Fax-on-Demand from a touch-tone telephone at 512 418 1111.

## E-Mail Support (Currently USA Only)

You can submit technical support questions to the applications engineering team through e-mail at the Internet address listed below. Remember to include your name, address, and phone number so we can contact you with solutions and suggestions.

support@natinst.com

## Telephone and Fax Support

National Instruments has branch offices all over the world. Use the list below to find the technical support number for your country. If there is no National Instruments office in your country, contact the source from which you purchased your software to obtain support.

<b>Country</b>	<b>Telephone</b>	<b>Fax</b>
Australia	03 9879 5166	03 9879 6277
Austria	0662 45 79 90 0	0662 45 79 90 19
Belgium	02 757 00 20	02 757 03 11
Brazil	011 288 3336	011 288 8528
Canada (Ontario)	905 785 0085	905 785 0086
Canada (Quebec)	514 694 8521	514 694 4399
Denmark	45 76 26 00	45 76 26 02
Finland	09 725 725 11	09 725 725 55
France	01 48 14 24 24	01 48 14 24 14
Germany	089 741 31 30	089 714 60 35
Hong Kong	2645 3186	2686 8505
Israel	03 6120092	03 6120095
Italy	02 413091	02 41309215
Japan	03 5472 2970	03 5472 2977
Korea	02 596 7456	02 596 7455
Mexico	5 520 2635	5 520 3282
Netherlands	0348 433466	0348 430673
Norway	32 84 84 00	32 84 86 00
Singapore	2265886	2265887
Spain	91 640 0085	91 640 0533
Sweden	08 730 49 70	08 730 43 70
Switzerland	056 200 51 51	056 200 51 55
Taiwan	02 377 1200	02 737 4644
United Kingdom	01635 523545	01635 523154
United States	512 795 8248	512 794 5678

# Technical Support Form

Photocopy this form and update it each time you make changes to your software or hardware, and use the completed copy of this form as a reference for your current configuration. Completing this form accurately before contacting National Instruments for technical support helps our applications engineers answer your questions more efficiently.

If you are using any National Instruments hardware or software products related to this problem, include the configuration forms from their user manuals. Include additional pages if necessary.

Name \_\_\_\_\_

Company \_\_\_\_\_

Address \_\_\_\_\_

\_\_\_\_\_

Fax ( \_\_\_\_ ) \_\_\_\_\_ Phone ( \_\_\_\_ ) \_\_\_\_\_

Computer brand \_\_\_\_\_ Model \_\_\_\_\_ Processor \_\_\_\_\_

Operating system (include version number) \_\_\_\_\_

Clock speed \_\_\_\_\_ MHz RAM \_\_\_\_\_ MB Display adapter \_\_\_\_\_

Mouse \_\_\_yes \_\_\_no Other adapters installed \_\_\_\_\_

Hard disk capacity \_\_\_\_\_ MB Brand \_\_\_\_\_

Instruments used \_\_\_\_\_

\_\_\_\_\_

National Instruments hardware product model \_\_\_\_\_ Revision \_\_\_\_\_

Configuration \_\_\_\_\_

National Instruments software product \_\_\_\_\_ Version \_\_\_\_\_

Configuration \_\_\_\_\_

The problem is: \_\_\_\_\_

\_\_\_\_\_

\_\_\_\_\_

\_\_\_\_\_

\_\_\_\_\_

List any error messages: \_\_\_\_\_

\_\_\_\_\_

\_\_\_\_\_

The following steps reproduce the problem: \_\_\_\_\_

\_\_\_\_\_

\_\_\_\_\_

\_\_\_\_\_

\_\_\_\_\_

# Hardware and Software Configuration Form

Record the settings and revisions of your hardware and software on the line to the right of each item. Complete a new copy of this form each time you revise your software or hardware configuration, and use this form as a reference for your current configuration. Completing this form accurately before contacting National Instruments for technical support helps our applications engineers answer your questions more efficiently.

## National Instruments Products

GPIO interface type and revision \_\_\_\_\_

GPIO software for Windows NT version number on disk \_\_\_\_\_

Programming language interface version \_\_\_\_\_

Shield ground connected to logic ground (yes or no) \_\_\_\_\_

Diagnostic utility results \_\_\_\_\_

Board settings:

	<b>Base I/O Address</b>	<b>Interrupt Level</b>	<b>DMA Channel</b>
gpib0	_____	_____	_____
gpib1	_____	_____	_____
gpib2	_____	_____	_____
gpib3	_____	_____	_____

## Other Products

Computer make and model \_\_\_\_\_

Microprocessor \_\_\_\_\_

Clock frequency or speed \_\_\_\_\_

Type of monitor card installed \_\_\_\_\_

Windows NT version \_\_\_\_\_

Application programming language (Microsoft C, and so on) \_\_\_\_\_

Other boards in system \_\_\_\_\_

Base I/O address of other boards \_\_\_\_\_

Interrupt level of other boards \_\_\_\_\_

DMA channels of other boards \_\_\_\_\_

# Documentation Comment Form

National Instruments encourages you to comment on the documentation supplied with our products. This information helps us provide quality products to meet your needs.

**Title:** *Getting Started with Your PCI-GPIB or PCMCIA-GPIB and the GPIB Software for Windows NT*

**Edition Date:** January 1998

**Part Number:** 321289B-01

Please comment on the completeness, clarity, and organization of the manual.

---

---

---

---

---

---

---

---

If you find errors in the manual, please record the page numbers and describe the errors.

---

---

---

---

---

---

---

---

Thank you for your help.

Name \_\_\_\_\_

Title \_\_\_\_\_

Company \_\_\_\_\_

Address \_\_\_\_\_

E-Mail Address \_\_\_\_\_

Phone ( \_\_\_\_ ) \_\_\_\_\_ Fax ( \_\_\_\_ ) \_\_\_\_\_

**Mail to:** Technical Publications  
National Instruments Corporation  
6504 Bridge Point Parkway  
Austin, Texas 78730-5039

**Fax to:** Technical Publications  
National Instruments Corporation  
512 794 5678

## Glossary

Prefix	Meanings	Value
m-	milli-	$10^{-3}$
c-	centi-	$10^{-2}$
M-	mega-	$10^6$

° degrees

% percent

A amperes

ANSI American National Standards Institute

ASIC application-specific integrated circuit

C Celsius

DIP dual inline package

EMI electromagnetic interference

FCC Federal Communications Commission

GPIB General Purpose Interface Bus

Hz hertz

IEEE Institute of Electrical and Electronic Engineers

in. inches

I/O input/output

ISA Industry Standard Architecture

*Glossary*

kernel	set of programs in an operating system that implements basic system functions
m	meters
MB	megabytes of memory
PC	personal computer
PCI	peripheral component interconnect
PCMCIA	Personal Computer Memory Card International Association
RAM	random-access memory
s	seconds
VDC	volts direct current