

Serial

Getting Started with Your PCI Serial Hardware and Software for Windows 95

Internet Support

E-mail: support@natinst.com

FTP Site: [ftp.natinst.com](ftp://ftp.natinst.com)

Web Address: <http://www.natinst.com>

Bulletin Board Support

BBS United States: 512 794 5422

BBS United Kingdom: 01635 551422

BBS France: 01 48 65 15 59

Fax-on-Demand Support

512 418 1111

Telephone Support (USA)

Tel: 512 795 8248

Fax: 512 794 5678

International Offices

Australia 03 9879 5166, Austria 0662 45 79 90 0, Belgium 02 757 00 20, Brazil 011 288 3336,
Canada (Ontario) 905 785 0085, Canada (Québec) 514 694 8521, Denmark 45 76 26 00, Finland 09 725 725 11,
France 01 48 14 24 24, Germany 089 741 31 30, Hong Kong 2645 3186, Israel 03 6120092, Italy 02 413091,
Japan 03 5472 2970, Korea 02 596 7456, Mexico 5 520 2635, Netherlands 0348 433466, Norway 32 84 84 00,
Singapore 2265886, Spain 91 640 0085, Sweden 08 730 49 70, Switzerland 056 200 51 51, Taiwan 02 377 1200,
United Kingdom 01635 523545

National Instruments Corporate Headquarters

6504 Bridge Point Parkway Austin, Texas 78730-5039 USA Tel: 512 794 0100

Important Information

Warranty

The serial hardware is warranted against defects in materials and workmanship for a period of two years from the date of shipment, as evidenced by receipts or other documentation. National Instruments will, at its option, repair or replace equipment that proves to be defective during the warranty period. This warranty includes parts and labor.

The media on which you receive National Instruments software are warranted not to fail to execute programming instructions, due to defects in materials and workmanship, for a period of 90 days from date of shipment, as evidenced by receipts or other documentation. National Instruments will, at its option, repair or replace software media that do not execute programming instructions if National Instruments receives notice of such defects during the warranty period. National Instruments does not warrant that the operation of the software shall be uninterrupted or error free.

A Return Material Authorization (RMA) number must be obtained from the factory and clearly marked on the outside of the package before any equipment will be accepted for warranty work. National Instruments will pay the shipping costs of returning to the owner parts which are covered by warranty.

National Instruments believes that the information in this manual is accurate. The document has been carefully reviewed for technical accuracy. In the event that technical or typographical errors exist, National Instruments reserves the right to make changes to subsequent editions of this document without prior notice to holders of this edition. The reader should consult National Instruments if errors are suspected. In no event shall National Instruments be liable for any damages arising out of or related to this document or the information contained in it.

EXCEPT AS SPECIFIED HEREIN, NATIONAL INSTRUMENTS MAKES NO WARRANTIES, EXPRESS OR IMPLIED, AND SPECIFICALLY DISCLAIMS ANY WARRANTY OF MERCHANTABILITY OR FITNESS FOR A PARTICULAR PURPOSE. CUSTOMER'S RIGHT TO RECOVER DAMAGES CAUSED BY FAULT OR NEGLIGENCE ON THE PART OF NATIONAL INSTRUMENTS SHALL BE LIMITED TO THE AMOUNT THEREOF PAID BY THE CUSTOMER. NATIONAL INSTRUMENTS WILL NOT BE LIABLE FOR DAMAGES RESULTING FROM LOSS OF DATA, PROFITS, USE OF PRODUCTS, OR INCIDENTAL OR CONSEQUENTIAL DAMAGES, EVEN IF ADVISED OF THE POSSIBILITY THEREOF. This limitation of the liability of National Instruments will apply regardless of the form of action, whether in contract or tort, including negligence. Any action against National Instruments must be brought within one year after the cause of action accrues. National Instruments shall not be liable for any delay in performance due to causes beyond its reasonable control. The warranty provided herein does not cover damages, defects, malfunctions, or service failures caused by owner's failure to follow the National Instruments installation, operation, or maintenance instructions; owner's modification of the product; owner's abuse, misuse, or negligent acts; and power failure or surges, fire, flood, accident, actions of third parties, or other events outside reasonable control.

Copyright

Under the copyright laws, this publication may not be reproduced or transmitted in any form, electronic or mechanical, including photocopying, recording, storing in an information retrieval system, or translating, in whole or in part, without the prior written consent of National Instruments Corporation.

Trademarks

CVI™ and LabVIEW™ are trademarks of National Instruments Corporation.

Product and company names referred to in this manual are trademarks or trade names of their respective companies.

WARNING REGARDING MEDICAL AND CLINICAL USE OF NATIONAL INSTRUMENTS PRODUCTS

National Instruments products are not designed with components and testing intended to ensure a level of reliability suitable for use in treatment and diagnosis of humans. Applications of National Instruments products involving medical or clinical treatment can create a potential for accidental injury caused by product failure, or by errors on the part of the user or application designer. Any use or application of National Instruments products for or involving medical or clinical treatment must be performed by properly trained and qualified medical personnel, and all traditional medical safeguards, equipment, and procedures that are appropriate in the particular situation to prevent serious injury or death should always continue to be used when National Instruments products are being used. National Instruments products are NOT intended to be a substitute for any form of established process, procedure, or equipment used to monitor or safeguard human health and safety in medical or clinical treatment.

Compliance

FCC/DOC Radio Frequency Interference Compliance

This equipment generates and uses radio frequency energy and, if not installed and used in strict accordance with the instructions in this manual, may cause interference to radio and television reception. Classification requirements are the same for the Federal Communications Commission (FCC) and the Canadian Department of Communications (DOC). The FCC/DOC classification is indicated on a label on the devices. If an FCC ID is present, the equipment is Class B; otherwise, it is Class A. Look at the product to determine the classification, then read the appropriate information below regarding the compliance of your product:

Class A

Federal Communications Commission

This equipment has been tested and found to comply with the limits for a Class A digital device, pursuant to part 15 of the FCC Rules. These limits are designed to provide reasonable protection against harmful interference when the equipment is operated in a commercial environment. This equipment generates, uses, and can radiate radio frequency energy and, if not installed and used in accordance with the instruction manual, may cause harmful interference to radio communications. Operation of this equipment in a residential area is likely to cause harmful interference in which case the user will be required to correct the interference at his own expense.

Canadian Department of Communications

This Class A digital apparatus meets all requirements of the Canadian Interference-Causing Equipment Regulations.

Cet appareil numérique de la classe A respecte toutes les exigences du Règlement sur le matériel brouilleur du Canada.

Class B

Federal Communications Commission

This equipment has been tested and found to comply with the limits for a Class B digital device, pursuant to part 15 of the FCC Rules. These limits are designed to provide reasonable protection against harmful interference in a residential installation. This equipment generates, uses and can radiate radio frequency energy and, if not installed and used in accordance with the instructions, may cause harmful interference to radio communications. However, there is no guarantee that interference will not occur in a particular installation. If this equipment does cause harmful interference to radio or television reception, which can be determined by turning the equipment off and on, the user is encouraged to try to correct the interference by one or more of the following measures:

- Reorient or relocate the receiving antenna.
- Increase the separation between the equipment and receiver.
- Connect the equipment into an outlet on a circuit different from that to which the receiver is connected.
- Consult the dealer or an experienced radio/TV technician for help.

Canadian Department of Communications

This Class B digital apparatus meets all requirements of the Canadian Interference-Causing Equipment Regulations.

Cet appareil numérique de la classe B respecte toutes les exigences du Règlement sur le matériel brouilleur du Canada.

FCC Notices to User

Changes or modifications not expressly approved by National Instruments could void the user's authority to operate the equipment under the FCC Rules.

This device complies with the FCC rules only if used with shielded interface cables of suitable quality and construction. National Instruments used such cables to test this device and provides them for sale to the user. The use of inferior or nonshielded interface cables could void the user's authority to operate the equipment under the FCC rules.

If necessary, consult National Instruments or an experienced radio/television technician for additional suggestions. The following booklet prepared by the FCC may also be helpful: Interference to Home Electronic Entertainment Equipment Handbook. This booklet is available from the U.S. Government Printing Office, Washington, DC 20402.

Contents

About This Manual

Organization of This Manual	xi
Conventions Used in This Manual.....	xii
Related Documentation.....	xiii
Customer Communication	xiii

Chapter 1

Introduction

How to Use This Manual	1-1
What You Need to Get Started	1-2
Optional Equipment	1-2
Serial Hardware Overview.....	1-2
NI Serial Software Overview.....	1-3
Optional Programming Tools	1-4
Using the Serial Hardware with Other National Instruments Products	1-4

Chapter 2

Installation and Verification

Install the NI Serial Software.....	2-1
Install the PCI Serial Hardware	2-3
Verify the Installation	2-4
Verify the Hardware Resources.....	2-5
Determine Which Physical Port Is Associated with COMx.....	2-5
Run the Diagnostic Test	2-6
Connect the Cables	2-6
Connecting Two-Wire Devices	2-10

Chapter 3

Configuration

Change/View Communication Port Settings	3-1
Communication Port Settings	3-2
Bits per Second.....	3-3
Data Bits	3-3
Parity.....	3-3
Stop Bits	3-3
Flow Control.....	3-3

Advanced Port Settings	3-3
Transceiver Mode	3-4
FIFO Buffers.....	3-4

Chapter 4 Using Your Serial Hardware

Advanced Transceiver Control for the PCI-485.....	4-1
Four-Wire Mode	4-1
Two-Wire Mode: DTR with Echo	4-1
Two-Wire Mode: DTR Controlled	4-2
Two-Wire Mode: TXRDY Auto Control.....	4-2
Setting the Transceiver Control Mode	4-2
Setting the Transceiver Mode with DeviceIoControl	4-3
General Programming Requirements	4-4
Other Programming Points.....	4-4

Appendix A Specifications

Hardware Specifications.....	A-1
Software Specifications.....	A-3

Appendix B Forcing Windows 95 to Detect the Serial Hardware

Appendix C Serial Port Information

RS-232.....	C-1
RS-422.....	C-1
RS-485.....	C-2
Serial Communication Issues	C-3
Duplex Architectures	C-3
Termination	C-4
Bias Resistors.....	C-5
DTE vs. DCE	C-6

Appendix D Uninstalling the Serial Hardware and Software

Removing the Hardware Information.....	D-1
Uninstalling the NI Serial Software	D-3

Appendix E Troubleshooting and Common Questions

Freeing an Interrupt Request Level	E-1
Selecting Conflict-Free Resources.....	E-2
Troubleshooting Diagnostic Messages	E-2
Resolving Resource Conflicts with Legacy Boards	E-3
Common Questions.....	E-3

Appendix F Customer Communication

Glossary

Figures

Figure 2-1.	Add/Remove Programs Properties Dialog Box.....	2-1
Figure 2-2.	NI Serial Setup Screen	2-2
Figure 2-3.	PCI Serial Board Installation.....	2-3
Figure 2-4.	Device Manager Ports List for PCI Serial Board Correctly Installed	2-5
Figure 2-5.	DB-9 Connector Pin Locations	2-7
Figure 2-6.	10-Position Modular Jack Pin Locations.....	2-8
Figure 2-7.	DB-25 Connector Pin Locations	2-9
Figure 2-8.	Connecting the Cables to Your Four-Port PCI Serial Board.....	2-10
Figure 3-1.	Port Settings Tab	3-2
Figure 3-2.	Advanced Port Settings Dialog Box.....	3-3
Figure B-1.	Port Selected in Device Manager	B-2
Figure C-1.	Typical Full-Duplex System	C-4
Figure C-2.	Typical Half-Duplex System.....	C-4
Figure C-3.	Multidrop Network Using Terminating Resistors	C-5
Figure C-4.	Transmission Line Using Bias Resistors.....	C-6
Figure C-5.	Straight-Through Cabling in a DTE-to-DCE Interface	C-7
Figure C-6.	Null-Modem Cabling in a DTE-to-DCE Interface.....	C-7
Figure D-1.	Selecting an Interface to Uninstall	D-2
Figure D-2.	Add/Remove Programs Properties Dialog Box.....	D-3
Figure D-3.	Uninstallation Results.....	D-4
Figure E-1.	Multi-Function Adapter Class in the Device Manager	E-5

Tables

Table 2-1.	DB-9 Pin Descriptions	2-7
Table 2-2.	10-Position Modular Jack Pin Descriptions.....	2-8
Table 2-3.	DB-25 Pin Descriptions	2-9
Table 4-1.	Transceiver Control Modes.....	4-1
Table 4-2.	Transceiver Mode Control Bytes	4-3
Table 4-3.	DeviceIoControl Function Input Values	4-3
Table A-1.	Physical Characteristics of the Two-Port PCI Serial Boards	A-1
Table A-2.	Physical Characteristics of the Four-Port PCI Serial Boards.....	A-2
Table A-3.	Physical Characteristics of the Eight-Port PCI Serial Boards	A-2
Table A-4.	Environmental Characteristics of the Serial Hardware.....	A-3
Table A-5.	Software Characteristics	A-3
Table C-1.	RS-232, RS-422, and RS-485 Features.....	C-2
Table E-1.	Standard DOS-Based Addresses	E-4

About This Manual

This manual contains instructions to help you install and configure the National Instruments serial hardware and the NI Serial software for Windows 95. The serial hardware covered by this manual includes the PCI-232/2, PCI-232/4, PCI-485/2, PCI-485/4, and PCI-232/8. This manual assumes that you are already familiar with Windows 95.

Organization of This Manual

- Chapter 1, *Introduction*, explains how to use this manual, lists what you need to get started and optional equipment you can order, and briefly describes the serial hardware and the NI Serial software.
- Chapter 2, *Installation and Verification*, contains instructions to help you install the serial hardware, NI Serial software, and cables.
- Chapter 3, *Configuration*, contains instructions to help you view or change the communication port settings.
- Chapter 4, *Using Your Serial Hardware*, describes how to set the hardware transceiver control mode for your RS-485 interfaces and lists some general programming requirements.
- Appendix A, *Specifications*, describes the characteristics of the serial hardware and the NI Serial Software, along with the recommended operating conditions.
- Appendix B, *Forcing Windows 95 to Detect the Serial Hardware*, describes how to troubleshoot problems and answers some common questions.
- Appendix C, *Serial Port Information*, discusses the RS-232, RS-422, and RS-485 standards and explains some of the different issues involved with these types of serial communication.
- Appendix D, *Uninstalling the Serial Hardware and Software*, explains how to uninstall your serial hardware and NI Serial software.
- Appendix E, *Troubleshooting and Common Questions*, describes how to troubleshoot problems and answers some common questions.

- Appendix F, *Customer Communication*, contains forms you can use to request help from National Instruments or to comment on our products and manuals.
- The *Glossary* contains an alphabetical list and description of terms used in this manual, including abbreviations, acronyms, metric prefixes, mnemonics, and symbols.

Conventions Used in This Manual

The following conventions are used in this manual.

» The » symbol leads you through nested menu items and dialog box options to a final action. The sequence **File»Page Setup»Options» Substitute Fonts** directs you to pull down the **File** menu, select the **Page Setup** item, select **Options**, and finally select the **Substitute Fonts** options from the last dialog box.



This icon to the left of bold italicized text denotes a note, which alerts you to important information.

bold Bold text denotes the names of menus, menu items, parameters, dialog boxes, dialog box buttons or options, icons, windows, Windows 95 tabs, or LEDs.

bold italic Bold italic text denotes an activity objective, note, caution, or warning.

italic Italic text denotes variables, emphasis, a cross reference, or an introduction to a key concept. This font also denotes text from which you supply the appropriate word or value, as in Windows 3.x.

monospace Text in this font denotes text or characters that you should literally enter from the keyboard, sections of code, programming examples, and syntax examples. This font is also used for the proper names of disk drives, paths, directories, programs, subprograms, subroutines, device names, functions, operations, variables, filenames and extensions, and for statements and comments taken from programs.

monospace bold Bold text in this font denotes the messages and responses that the computer automatically prints to the screen. This font also emphasizes lines of code that are different from the other examples.

monospace italic Italic text in this font denotes that you must enter the appropriate words or values in the place of these items.

Related Documentation

The following documents contain information that you may find helpful as you read this manual:

- ANSI/EIA-232-D Standard, *Interface Between Data Terminal Equipment and Data Circuit-Terminating Equipment Employing Serial Binary Data Interchange*
- EIA/RS-422-A Standard, *Electrical Characteristics of Balanced Voltage Digital Interface Circuits*
- EIA-485 Standard, *Standard for Electrical Characteristics of Generators and Receivers for Use in Balanced Digital Multipoint Systems*
- *Microsoft Win32 Software Developer Kit*, Online Documentation for *Win32 Overviews*, *Win32 Reference*, and *Programmer's Guide to Windows 95*, Microsoft Corporation
- *NS16550AF Universal Asynchronous Receiver/Transmitter with FIFOs*, National Semiconductor
- *ST16C654 Asynchronous Receiver/Transmitter with FIFOs*, EXAR Corporation

Customer Communication

National Instruments wants to receive your comments on our products and manuals. We are interested in the applications you develop with our products, and we want to help if you have problems with them. To make it easy for you to contact us, this manual contains comment and configuration forms for you to complete. These forms are in Appendix F, [Customer Communication](#), at the end of this manual.

Introduction

This chapter explains how to use this manual, lists what you need to get started and optional equipment you can order, and briefly describes the serial hardware and the NI Serial software.

How to Use This Manual

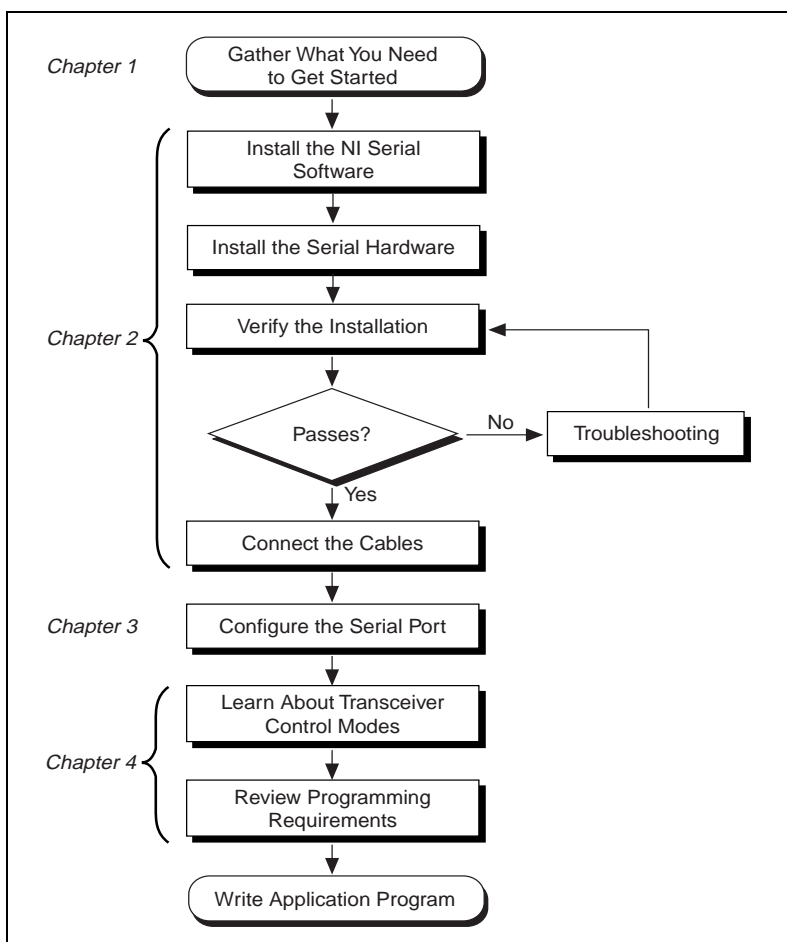

What You Need to Get Started

Make sure you have all of the items listed before you attempt to install the serial hardware.

- One of the following, which is included in your kit:
 - PCI-232 (two, four, or eight port)
 - PCI-485 (two or four port)
- 3.5 in. high density disk (1.44 MB) *NI Serial Software for Windows 95 and Windows NT*, which is included in your kit
- Microsoft Windows 95 installed on your computer

Optional Equipment

Call National Instruments for more information about the following optional equipment:

- DB-9 RS-485 termination connector (PCI-485 only)
- 10-position modular jack to DB-9 cable (four-port interfaces only)
- 10-position modular jack to DB-25 cable (four-port interfaces only)
- RS-232 9-pin to 9-pin null modem cable
- RS-232 9-pin to 25-pin null modem cable

Serial Hardware Overview

The serial hardware gives you a variety of solutions for serial communications. The PCI-232 board works with the RS-232 protocols, and the PCI-485 board works with the RS-422 and RS-485 protocols. You can use the PCI-232 hardware for serial communication up to distances of 50 ft. Using serial cable lengths up to 4,000 ft., you can connect the PCI-485 hardware with up to 31 devices.

Additionally, the PCI-232 and PCI-485 boards are available in a two-port version (PCI-232/2 and PCI-485/2), a four-port version (PCI-232/4 and PCI-485/4), and an eight-port version (PCI-232/8). The two-port versions use DB-9 connectors. The four-port versions use 10-position modular jacks to provide all four connections on a single back panel. Optional cable accessories convert the 10-position modular jacks to either DB-9 or DB-25 connectors with standard pinouts. The eight-port versions use an adapter

cable to convert the 68-pin connector on the board to eight DB-9 connectors. Throughout this manual, references to *PCI-232* and *PCI-485* generally refer to either version.

The PCI-485 boards support four hardware transceiver control modes for reliable communication with two-wire and four-wire devices. Refer to Chapter 4, *Using Your Serial Hardware*, for more information about transceiver control modes.

All of the serial hardware uses standard 16550-compatible UARTs (Universal Asynchronous Receiver/Transmitters) for 100% compatibility with standard PC COM ports. The serial hardware contains FIFOs (First-In-First-Out buffers) for reduced susceptibility to interrupt latency and faster transmission rates. Full Plug and Play compatibility gives you the convenience of switchless configuration and installation. Refer to Appendix A, *Specifications*, for more information about the serial hardware specifications and operating conditions.

NI Serial Software Overview

The NI Serial software for Windows 95 includes a native Windows device driver that can provide full interrupt-driven, buffered I/O for multiple COM ports. Using this driver, you can obtain a maximum baud rate of 460.8 KBaud on the PCI-485 and 115.2 KBaud on the PCI-232, and you can use any number of serial ports under Windows 95. The NI Serial software also provides a configuration utility, which is integrated with the Windows 95 Device Manager. Refer to Appendix A, *Specifications*, for more information about software specifications and recommended operating conditions.

The NI Serial software includes the following components:

- Device driver
- Diagnostic test
- Configuration utility

The NI Serial software supports all National Instruments serial hardware, including all AT, PCI, and PCMCIA versions.

Optional Programming Tools

Your kit includes the NI Serial software for Windows 95 and Windows NT. In addition, you can order the LabWindows/CVI or LabVIEW software from National Instruments. LabWindows/CVI and LabVIEW include instrument driver libraries that make it easier to communicate with your serial instruments.

LabWindows/CVI is an interactive ANSI C development environment for building test and measurement and instrument control systems. It includes interactive code-generation tools and a graphical editor for building custom user interfaces. It also includes built-in libraries for IEEE 488.2, VXI, RS-232 control, and plug-in data acquisition. When you order LabWindows/CVI, you also get hundreds of complete instrument drivers, which are modular, source-code programs that handle the communication with your instrument so that you do not have to learn the programming details.

LabVIEW is a complete programming environment that departs from the sequential nature of traditional programming languages and features a graphical programming environment. It includes all the tools needed for instrument control, data acquisition, analysis, and presentation. LabVIEW also includes an extensive instrument driver library.

For more information about LabWindows/CVI and LabVIEW, contact National Instruments.

Using the Serial Hardware with Other National Instruments Products

You can use standard serial I/O functions in LabVIEW and LabWindows/CVI with any National Instruments serial interface, once you have installed the hardware and software. If you already have LabVIEW or LabWindows and want to use it with your serial hardware, refer to your LabVIEW or LabWindows documentation for information about serial I/O functions.

Installation and Verification

This chapter contains instructions to help you install the serial hardware, NI Serial software, and cables.

Install the NI Serial Software

Before installing the hardware, complete the following steps to install the NI Serial software for Windows 95.

1. Select **Start»Settings»Control Panel**.
2. Double-click on the **Add/Remove Programs** icon in the Control Panel to launch the Add/Remove Programs applet. A dialog box similar to the one in Figure 2-1 appears.



Figure 2-1. Add/Remove Programs Properties Dialog Box

You can use this same applet to uninstall the NI Serial software at a later time if you want to. Refer to Appendix D, *Uninstalling the Serial Hardware and Software*, for more information.

3. Click on the **Install...** button.
4. Insert the *NI Serial Software for Windows 95 and Windows NT (Setup Disk)*, and click on the **Next** button to proceed.
5. The software installation wizard begins with the screen shown in Figure 2-2.

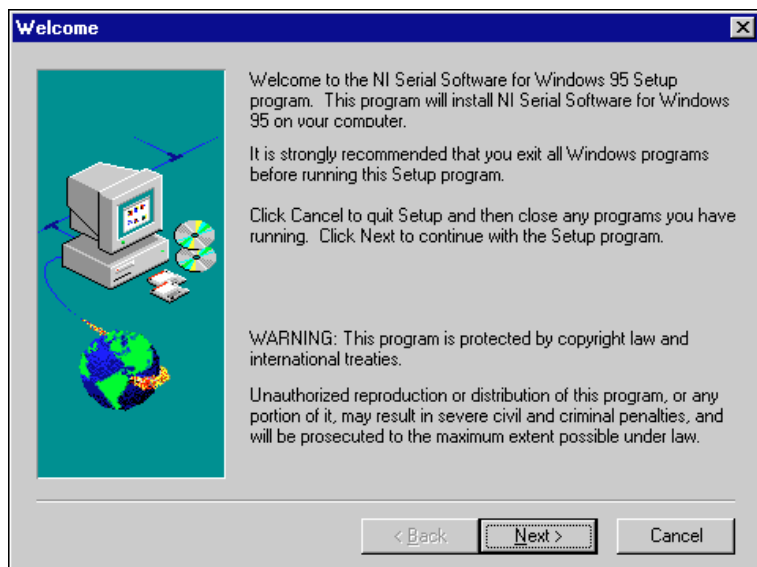

Figure 2-2. NI Serial Setup Screen

The setup wizard guides you through the necessary steps to install the NI Serial software. You may go back and change values where appropriate by clicking on the **Back**. You can exit the setup where appropriate by clicking on the **Cancel**.

6. If you need to install your hardware, or if this is your first time to install the NI Serial software for Windows 95, skip to the next section, *Install the PCI Serial Hardware*. Otherwise, continue to step 7.
7. If your hardware is already installed, restart Windows 95.

Windows 95 should automatically detect your hardware and display one or more **New Hardware Found** dialog boxes, but you must make sure **Windows Default Driver** is selected and click on **OK**.

If no **New Hardware Found** dialog box appears, follow the steps in Appendix B, *Forcing Windows 95 to Detect the Serial Hardware*.

Install the PCI Serial Hardware

Complete the following steps to install a PCI serial board.

**Note**

*If you are installing an PCI-485, you may need to adjust the value of the bias resistors, depending on your application. For more information, refer to Appendix C, *Serial Port Information*.*

1. Turn off your computer. Keep the computer plugged in so that it remains grounded while you install the PCI serial board.
2. Remove the top or side cover of the computer.
3. Remove the expansion slot cover on the back of the computer.
4. Insert the PCI serial board into an unused slot with the serial connectors sticking out of the opening on the back panel. Make sure that you insert the board all the way into the slot. The board may seem to click firmly into place, even though it is only part of the way in. Figure 2-3 shows the installation of a PCI serial board.

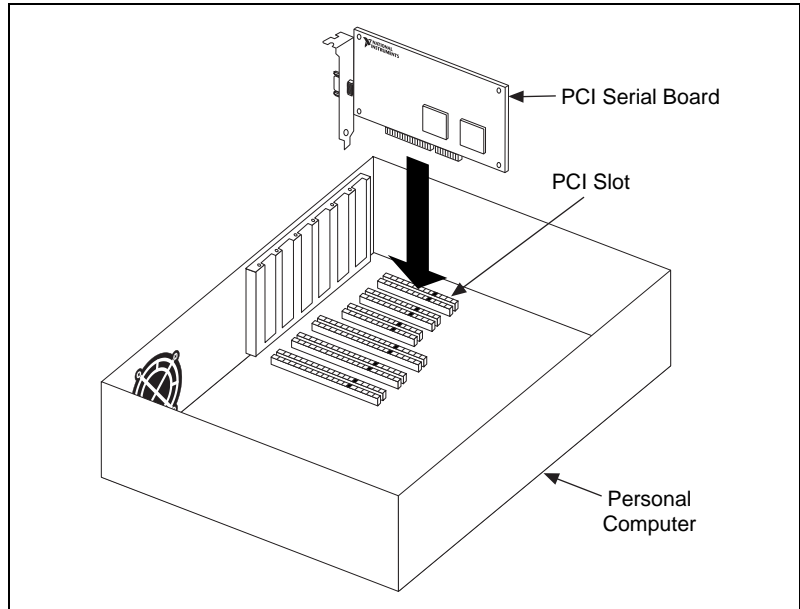

Figure 2-3. PCI Serial Board Installation

5. Screw the mounting bracket of the PCI serial board to the back panel rail of the computer.
6. Replace the cover, and turn on your computer.
7. Watch for Windows 95 to display one or more New Hardware Found dialog boxes. In the dialog box, select **Windows Default Driver** and click on **OK**. If no **New Hardware Found** dialog box appears, follow the steps in Appendix B, *Forcing Windows 95 to Detect the Serial Hardware*.

Your serial hardware is now installed.

Verify the Installation

When you begin to verify the installation, keep in mind that the serial ports built into the computer are typically named from COM1 to COM4. Windows 95 typically issues port names to the ports on NI serial hardware starting with COM5, COM6, and so on. If not enough resources are available to assign to all the NI serial ports, the port with the higher COMx name is left unconfigured.

Double-click on the **System** icon in the Control Panel. In the **System Properties** window that appears, select the **Device Manager** tab, and click the **View devices by type** button at the top of the page. If necessary, double-click on the **Ports (COM & LPT)** icon to view all of the ports.

The PCI-232 and PCI-485 boards are configured as devices belonging to the “multi-function adapters” class. The multi-function parent device is listed under the **Multi-function adapters** icon, and each child device is listed as a port under the **Ports (COM & LPT)** icon. Double-click on the **Multi-function adapters** icon as well as the **Ports (COM & LPT)** icon.

Figure 2-4 shows an example of NI serial hardware that is installed properly.

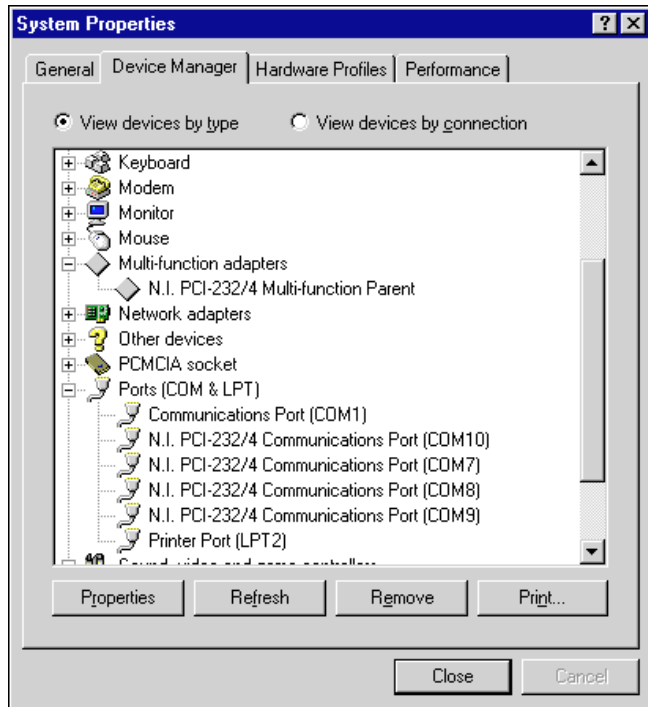

Figure 2-4. Device Manager Ports List for PCI Serial Board Correctly Installed

Verify the Hardware Resources

For every serial interface, double-click on the name of the serial card in the Device Manager under **Multi-function Adapters**. Then click on the **Resources** tab. If the resources were assigned correctly, the **Resources** page shows which resources are assigned to your serial ports.

When you have finished verifying the hardware resources, proceed to the next section.

Determine Which Physical Port Is Associated with COMx

For every port of the newly installed serial interface, double-click on the name of the serial port in the Device Manager. Then click on the **Port Settings** tab. The top of this page displays the serial number of the serial hardware, and the physical port number starting at 1. On all serial hardware, PORT1 refers to the top port, PORT2 refers to the next port down, and so on.

When you have finished verifying the driver installation and physical port, proceed to the next section.

Run the Diagnostic Test

To verify and test the installation, run the diagnostic program that came with your NI Serial software. The diagnostic program verifies that your serial driver is installed properly, that the configuration of your hardware does not conflict with anything else in your system, and that the serial driver can communicate with your hardware correctly.

To run the test, select the **diagnostics** item under **Start»Programs»NI Serial Software for Windows 95**.

If the diagnostic test completes with no failures, your serial hardware and software are installed properly. If it fails, refer to Appendix E, [Troubleshooting and Common Questions](#), for troubleshooting instructions.

Connect the Cables

For the two-port PCI serial boards, you can use the standard DB-9 connector found on most serial cables. To use the DB-9 connector with the four-port PCI serial boards, you need the 10-position modular jack to DB-9 cable available from National Instruments. You can also use a DB-25 connector with the four-port PCI serial boards by ordering the 10-position modular jack to DB-25 cable from National Instruments. The eight-port PCI serial ships with a pig tail cable adapter providing eight standard DB-9 connectors.

Figure 2-5 and Table 2-1 give the pin locations and descriptions of the DB-9 connector, which is found on the two-port PCI serial board, the 10-position modular jack to DB-9 cable, and the cable adapter for the eight-port board.

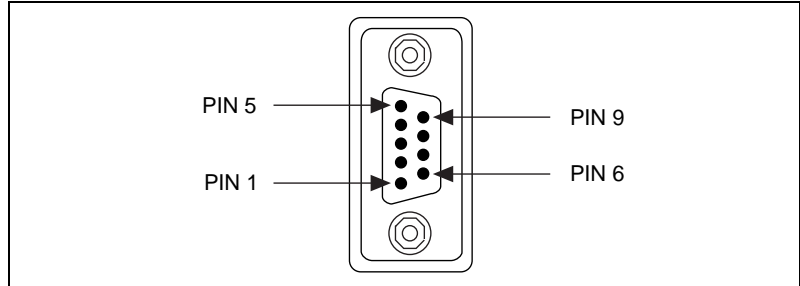

Figure 2-5. DB-9 Connector Pin Locations

Table 2-1. DB-9 Pin Descriptions

DB-9 Pin	232 Signal	485 Signal
Pin 1	DCD	GND
Pin 2	RXD	CTS+ (HSI+)
Pin 3	TXD	RTS+ (HSO+)
Pin 4	DTR	RXD+
Pin 5	GND	RXD-
Pin 6	DSR	CTS- (HSI-)
Pin 7	RTS	RTS- (HSO-)
Pin 8	CTS	TXD+
Pin 9	RI	TXD-

Figure 2-6 and Table 2-2 give the pin locations and descriptions of the 10-position modular jack, which is found on the four-port PCI serial board.

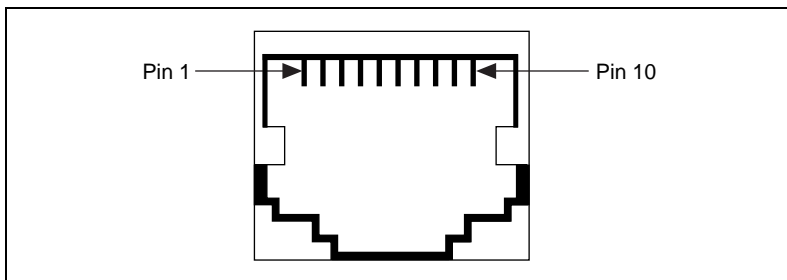

Figure 2-6. 10-Position Modular Jack Pin Locations

Table 2-2. 10-Position Modular Jack Pin Descriptions

10 Position Modular Jack	232 Signal	485 Signal
Pin 10	DCD	GND
Pin 9	RXD	CTS+ (HSI+)
Pin 8	TXD	RTS+ (HSO+)
Pin 7	DTR	RXD+
Pin 6	GND	RXD-
Pin 5	DSR	CTS- (HSI-)
Pin 4	RTS	RTS- (HSO-)
Pin 3	CTS	TXD+
Pin 2	RI	TXD-
Pin 1	No Connect	No Connect

Figure 2-7 and Table 2-3 give the pin locations and descriptions of the DB-25 connector, which is on the optional 10-position modular jack to DB-25 cable.

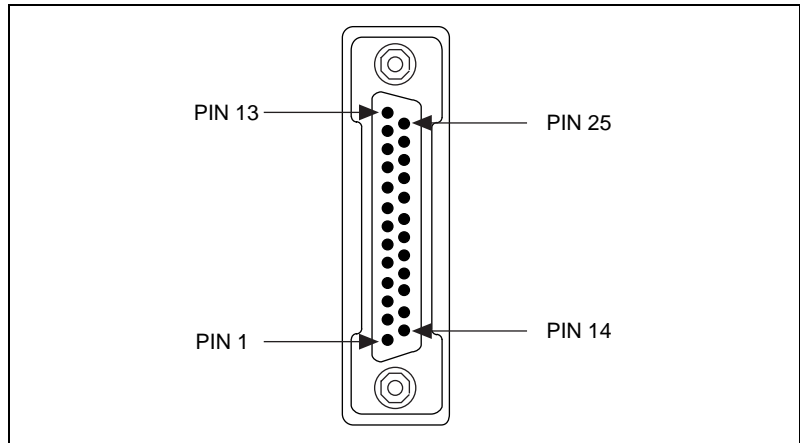

Figure 2-7. DB-25 Connector Pin Locations

Table 2-3. DB-25 Pin Descriptions

DB-25 Pin	232 Signal	485 Signal
Pin 2	TXD	RTS+ (HSO+)
Pin 3	RXD	CTS+ (HSI+)
Pin 4	RTS	RTS- (HSO-)
Pin 5	CTS	TXD+
Pin 6	DSR	CTS- (HSI-)
Pin 7	GND	RXD-
Pin 8	DCD	GND
Pin 20	DTR	RXD+
Pin 22	RI	TXD-
Pins not listed in this table are No Connect.		

Figure 2-8 shows how to connect the cables when you install a four-port version of the PCI serial board.

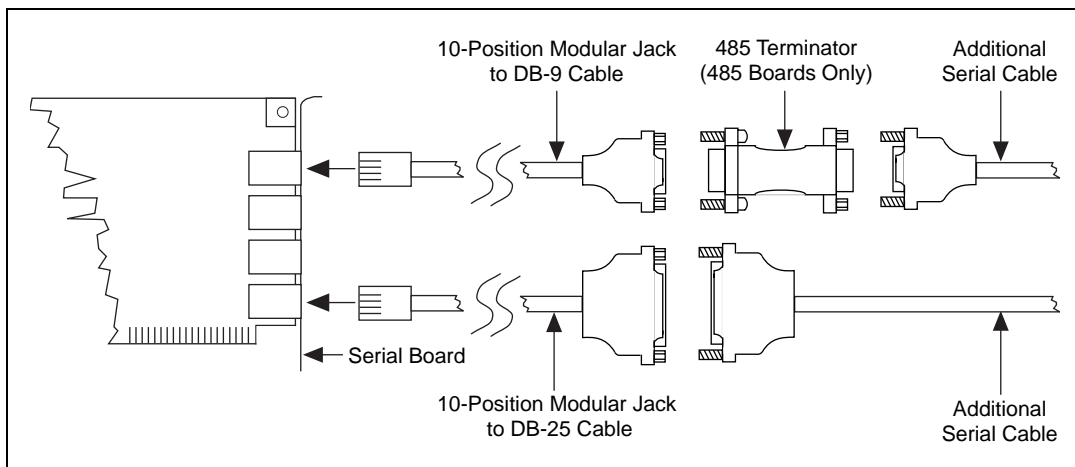

Figure 2-8. Connecting the Cables to Your Four-Port PCI Serial Board

Connecting Two-Wire Devices

The PCI-485 boards are designed to work with either two- or four-wire devices. If you are using a two-wire device, refer to the device documentation for specific wiring instructions.

In general, half-duplex networks use a single twisted pair of wires for communication in both directions, so you must connect both the transmitter and the receiver at each end of the same pair of wires. For example, to connect an RS-485 data acquisition device to a port on your PCI-485 using half-duplex communication, you need a single twisted pair of wires. At the PCI-485, you should connect the TXD+ and RXD+ signals (pins 8 and 4 on a DB-9 connector, pins 5 and 20 on a DB-25 connector) together and to one wire. You should connect the other end of this wire to both the TXD+ and RXD+ signals on the data acquisition device. You use the same method to connect the TXD- and RXD- signals (pins 9 and 5 on a DB-9 connector, pins 22 and 7 on a DB-25 connector) to the second wire.

Refer to Chapter 4, *Using Your Serial Hardware*, for information on setting the transceiver mode for two-wire communication. Refer to Appendix C, *Serial Port Information*, for more information on duplex architectures.

Configuration

This chapter contains instructions to help you view or change the communication port settings.

Change/View Communication Port Settings

The serial configuration utility is fully integrated with the Windows 95 Device Manager. You can use it to examine or modify the configuration of the serial port.

Follow these steps to configure the serial port. Repeat the configuration procedure for each serial port in your system.

1. Select **Start»Settings»Control Panel** and double-click on the **System** icon. The **System Properties** window appears.
2. Select the **Device Manager** tab, and click the **View devices by type** button at the top of the page.
3. Double-click the **Ports (COM & LPT)** icon.
4. Double-click on the name of the port you want to configure.

You can now view or change information about your serial port in the following ways:

- Click on the **Resources** tab to view information about the hardware resources assigned to the serial port.
- Click on the **Port Settings** tab to view information about the software configuration for the serial port. Refer to the next section, [Communication Port Settings](#), for more information.
- On the **Port Settings** tab, click on the **Advanced** button to change the RS-485 transceiver mode and to enable or disable the FIFOs on the serial hardware. Refer to the next section, [Communication Port Settings](#), for more information.

**Note**

Transceiver modes apply to RS-485 interfaces only. For more information about transceiver modes, refer to Chapter 4, [Using Your Serial Hardware](#).

After you have selected the serial port parameters for the current port, click on the **OK** button to save the changes or click on the **Cancel** button to exit the dialog box without saving changes.

Communication Port Settings

On the **Port Settings** tab, you can change any of the settings by clicking on the arrow button to the right of the setting. When you click on the arrow button, a list of valid values for that setting appears. Select the desired setting from the list. Figure 3-1 shows the **Port Settings** tab.

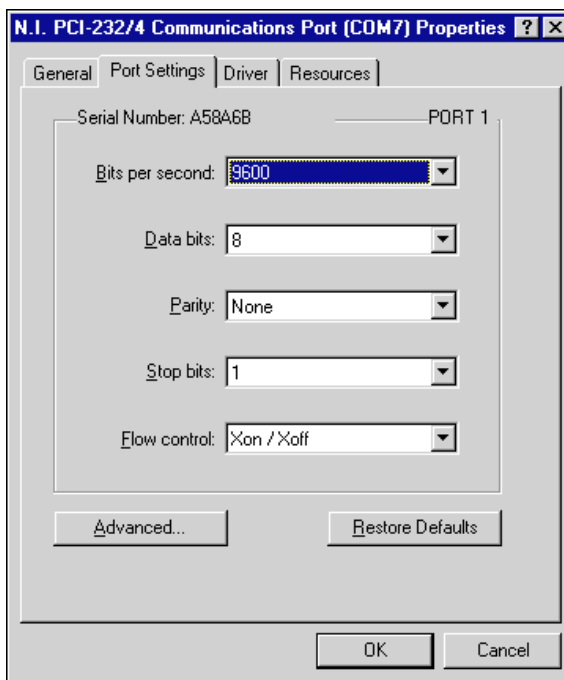

Figure 3-1. Port Settings Tab

The following sections describe the port settings available on the Device Manager **Port Settings** tab.

Bits per Second

Bits per second, or baud rate, is the speed for a serial port.

Data Bits

Data bits is the number of data bits in a single serial byte.

Parity

Parity is the specification for even, odd, or no parity bits in each transmitted byte.

Stop Bits

Stop bits is the number of terminating bits on the end of each transmitted serial byte.

Flow Control

Flow control is a method for temporarily halting the stream of serial bytes to prevent overflow.

Advanced Port Settings

You can view or change the advanced port settings by clicking on the **Advanced** button on the **Port Settings** tab. Figure 3-2 shows the **Advanced Port Settings** dialog box.

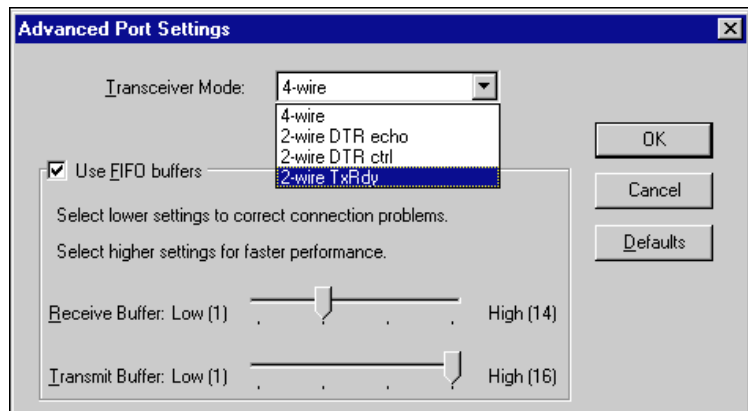

Figure 3-2. Advanced Port Settings Dialog Box

The following sections describe the advanced port setting options.

Transceiver Mode

The transceiver mode selection is available by clicking on the **Advanced** button on the **Port Settings** tab. It shows the transceiver mode in use, and applies only to AT-485 boards. Refer to Chapter 4, *Using Your Serial Hardware*, for more information about transceiver modes.

FIFO Buffers

The FIFO buffer control is available by clicking on the **Advanced** button on the **Port Settings** tab. FIFO buffers are present on the 16550-compatible UARTs—one for the transmitter and one for the receiver. Consider the following points when selecting FIFO settings:

- You can select larger FIFO settings to minimize system overhead.
- If transfer rates are high, you can lower receive FIFO settings to prevent overrun errors.
- If data sizes are small, selecting FIFO settings just above data sizes can reduce efficiency, so select lower settings.



Note

*If you want your serial hardware ports to use the names COM1, COM2, COM3, or COM4, refer to the [Common Questions](#) section of Appendix E, *Troubleshooting and Common Questions*.*

Using Your Serial Hardware

This chapter describes how to set the hardware transceiver control mode for your RS-485 interfaces and lists some general programming requirements.

Advanced Transceiver Control for the PCI-485

The PCI-485 boards support four modes of hardware transceiver control. (Transceiver modes apply only to these interfaces.) You can use hardware flow control to enable and disable your transmitters and receivers to work on different bus topologies. Table 4-1 lists the status of the transmitters and receivers under each of the transceiver control modes.

Table 4-1. Transceiver Control Modes

Mode	Transmitter	Receiver
Four-wire mode	Always enabled	Always enabled
Two-wire mode: with $\overline{\text{DTR}}$ echo	Enabled with $\overline{\text{DTR}}$ unasserted	Always enabled
Two-wire mode: $\overline{\text{DTR}}$ controlled	Enabled with $\overline{\text{DTR}}$ unasserted	Enabled with $\overline{\text{DTR}}$ asserted
Two-wire mode: $\overline{\text{TXRDY}}$ auto control	Enabled with $\overline{\text{TXRDY}}$ asserted	Enabled with $\overline{\text{TXRDY}}$ unasserted



Note

Signal names with an overscore, such as $\overline{\text{DTR}}$, indicate that the signal is active low.

Four-Wire Mode

Use the four-wire mode for most full-duplex systems. In this mode, the transmitter and receiver are always enabled. This mode is the default.

Two-Wire Mode: $\overline{\text{DTR}}$ with Echo

Use this mode in half-duplex systems where the $\overline{\text{DTR}}$ (Data Terminal Ready) line must control the transmitter. In the $\overline{\text{DTR}}$ -with-echo mode, the transmitter is tri-stated when the $\overline{\text{DTR}}$ signal of the UART (Universal

Asynchronous Receiver/Transmitter) is asserted. To transmit, your application must first clear the $\overline{\text{DTR}}$ bit to enable the transmitter. After the data is fully transmitted, your application once again sets the $\overline{\text{DTR}}$ bit to disable the transmitter. Because the receiver is always enabled in this mode, you not only receive packets from other devices, you also receive the packets sent from your transmitter.

Two-Wire Mode: $\overline{\text{DTR}}$ Controlled

This mode is similar to the two-wire, $\overline{\text{DTR}}$ -with-echo mode. Use this mode in half-duplex systems where the $\overline{\text{DTR}}$ line must control the transmitter. Although this mode uses the same method as the $\overline{\text{DTR}}$ -with-echo mode to control the transmitter, the hardware automatically disables the receiver whenever the transmitter is enabled. Thus, you do not receive packets that you have transmitted.

Two-Wire Mode: $\overline{\text{TXRDY}}$ Auto Control

In this mode, the hardware transparently enables the transmitter and receiver in a two-wire system. This mode removes the burden of flow control from the user software. By connecting the transmitter to the $\overline{\text{TXRDY}}$ (Transmit Ready) line, the hardware enables the transmitter for each byte to be transmitted. Also, the hardware disables the receiver whenever the transmitter is enabled, so you do not receive packets that you have transmitted.



Note

It is recommended that you use the two-wire $\overline{\text{TXRDY}}$ auto control mode when you are communicating with a two-wire device. Because this mode handles the transmitter/receiver enabling for a two-wire connection in your hardware, it reduces the software overhead required to perform this operation in your application program.

Setting the Transceiver Control Mode

The recommended method for setting the transceiver control mode is with the serial configuration utility located in the Windows 95 Device Manager. For more information, refer to the [Communication Port Settings](#) section in Chapter 3, [Configuration](#). The mode you select in the Device Manager is automatically configured when you open a port on a serial interface. You can also set the hardware transceiver control mode from within a DOS application. For each port you want to control, write the control byte for the mode you want to select to the scratch register of the UART. Table 4-2 shows the control bytes for each mode.

Table 4-2. Transceiver Mode Control Bytes

Transceiver Mode	Control Byte
Four-wire mode	0x00
Two-wire mode: $\overline{\text{DTR}}$ with echo	0x01
Two-wire mode: $\overline{\text{DTR}}$ controlled	0x02
Two-wire mode: $\overline{\text{TXRDY}}$ auto control	0x03

The scratch register is located at offset 7 from the base address of the port. For example, if COM2 were located at base address 0x3F8, and you wanted to set the PCI-485 board to two-wire mode with $\overline{\text{DTR}}$ control, you would write a 0x02 to I/O address 0x3FF. The PCI-485 board would immediately switch to the two-wire mode with $\overline{\text{DTR}}$ control.

Setting the Transceiver Mode with DeviceIoControl

The NI Serial software extends the Windows function `DeviceIoControl` for programming the transceiver control mode. To program the transceiver control mode using `DeviceIoControl`, complete the following steps.

1. Add the following lines to your source code.

```
#include <winioctl.h>

#define IOCTL_SERIAL_SET_TRANSCEIVER_MODE
CTL_CODE(FILE_DEVICE_SERIAL_PORT, 37, METHOD_BUFFERED,
FILE_ANY_ACCESS)
```

2. Use the Win32 function `DeviceIoControl`. Use the defined control code value listed in Step 1 to set the transceiver mode, and the input buffer values (unsigned long) listed in Table 4-3 for programming different transceiver modes.

Table 4-3. DeviceIoControl Function Input Values

Transceiver Mode	DeviceIoControl Function Input Value
Four-wire mode	128
Two-wire mode: $\overline{\text{DTR}}$ with echo	129
Two-wire mode: $\overline{\text{DTR}}$ controlled	130
Two-wire mode: $\overline{\text{TXRDY}}$ auto control	131

For example, to set TXRDY two-wire auto control mode, use the following call:

```
ULONG TranceiverMode = 131;  
DeviceIoControl(hDevice,  
IOCTL_SERIAL_SET_TRANSCEIVER_MODE, (PVOID)  
&TranceiverMode, sizeof(ULONG), lpOutBuffer,  
nOutBufferSize, lpBytesReturned, lpOverlapped);
```

General Programming Requirements

Once installed, the NI Serial software is integrated into the standard Windows 95 communications software. NI serial ports are used like any other Windows 95 communications (COM) port. Windows 95 has standard communication functions for use within either 16-bit (Win16) applications or 32-bit (Win32) applications.

Other Programming Points

As you begin developing your application, remember that you must use the standard Microsoft Windows serial communication functions. For information about Microsoft Windows serial communication functions, refer to the *Win32 Software Development Kit, Online help for Win32 Overviews and Win32 Reference*.

If you have LabVIEW or LabWindows and want to use it with your serial hardware, refer to your LabVIEW or LabWindows documentation for information about serial I/O functions.

Specifications

This appendix describes the characteristics of the serial hardware and the NI Serial software, along with the recommended operating conditions.

Hardware Specifications

Table A-1. Physical Characteristics of the Two-Port PCI Serial Boards

Characteristic	Specification
Dimensions	10.67 by 14.20 cm (4.2 by 5.6in.)
I/O Connector	DB-9
Power Requirement (from PCI channel)	
PCI-485/2	+5 VDC 350 mA Typical 750 mA Maximum
PCI-232/2	+5 VDC 50 mA Typical 100 mA Maximum
	±12 VDC 20 mA Typical 200 mA Maximum

Table A-2. Physical Characteristics of the Four-Port PCI Serial Boards

Characteristic	Specification
Dimensions	10.67 by 17.45 cm (4.2 by 6.8 in.)
I/O Connector*	10-position modular jack
Power Requirement (from PCI channel)	
PCI-485/4	+5 VDC 700 mA Typical 1300 mA Maximum
PCI-232/4	+5 VDC 70 mA Typical 150 mA Maximum
	±12 VDC 40 mA Typical 400 mA Maximum
* The four-port PCI serial board requires a cable to convert the 10-position modular jack to either DB-9 or DB-25 connectors.	

Table A-3. Physical Characteristics of the Eight-Port PCI Serial Boards

Characteristic	Specification
Dimensions	10.67 by 14.45 cm (4.2 by 5.7 in.)
I/O Connector*	68-position, SCSI type connector
Power Requirement (from PCI channel)	
PCI-232/8	+5 VDC 100 mA Typical 180 mA Maximum
	±12 VDC 80 mA Typical 800 mA Maximum
* The eight-port PCI serial board requires a cable, which is included in your kit, to convert the 68-position connector to eight DB-9 connectors.	

Table A-4. Environmental Characteristics of the Serial Hardware

Characteristic	Specification
Operating Environment	
Component Temperature	0° to 40° C
Relative Humidity	10% to 90%, noncondensing
Storage Environment	
Temperature	-20° to 70° C
Relative Humidity	5% to 90%, noncondensing
EMI	
PCI Serial	FCC Class A Verified

Software Specifications

Table A-5. Software Characteristics

Characteristic	Specification
Maximum Serial Transfer Rate	
RS-485	460,800 bps*
RS-232	115,200 bps*
Space Required for NI Serial Software	1 MB
* Actual speed may vary considerably from speed shown due to system and instrumentation capabilities.	

Forcing Windows 95 to Detect the Serial Hardware

This appendix describes how to troubleshoot problems and answers some common questions.

If Windows 95 does not detect your serial hardware correctly, it does not display the New Hardware Found dialog box. To fix this problem, follow these steps.

1. Select **Start»Settings»Control Panel**.
2. Double-click on the **System** icon.
3. Select the **Device Manager** page.
4. Click the **View devices by type** button.
5. Double-click on **Other Devices** where Windows 95 lists the ports it does not recognize. Double click on **Multifunction-Adapter** class where Windows 95 lists the parent devices of the PCI ports, the serial interface.
6. Select the National Instruments interface you are attempting to install, as shown in Figure B-1.

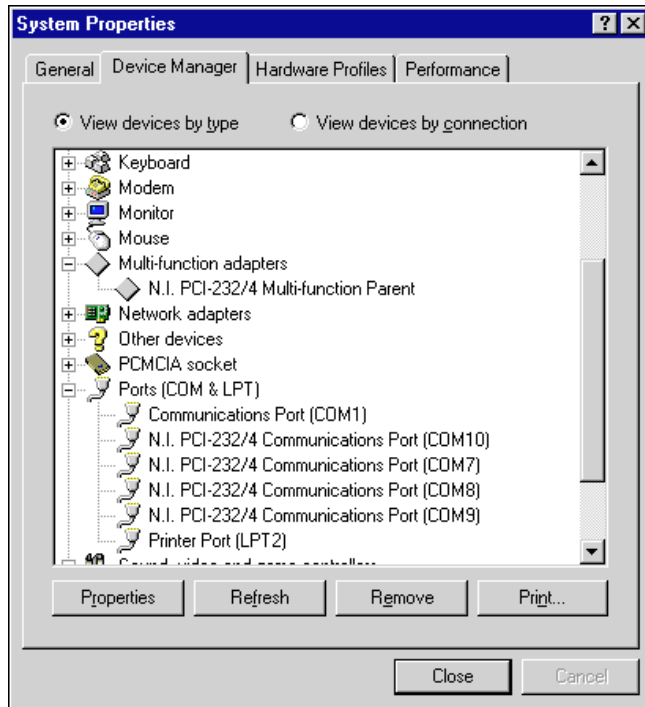

Figure B-1. Port Selected in Device Manager

7. Click the **Remove** button, and click on **OK** to confirm the removal of the serial hardware information.
8. Repeat steps 6 and 7 until all serial board entries are removed. Then click on **Refresh** to force Windows 95 to detect the serial hardware and display the **New Hardware Found** dialog box.



Serial Port Information

This appendix discusses the RS-232, RS-422, and RS-485 standards and explains some of the different issues involved with these types of serial communication.

RS-232

RS-232, as specified in the ANSI/EIA-232-D Standard, *Interface Between Data Terminal Equipment and Data Circuit-Terminating Equipment Employing Serial Binary Data Interchange*, standardizes serial communication between computers and between computer terminals and modems. Most applications use the RS-232 standard for interfacing peripherals to personal computers. RS-232 uses transmission lines in which the state of each signal is represented by referencing the voltage level of a single line to ground. RS-232 was designed for serial communication up to distances of 50 ft and with data rates up to 20 kb/s. However, because of improvements in line drivers and cabling, you can often increase the actual performance of the bus past the limitations on speed and distance recommended in the specification.

RS-422

RS-422, as specified in the EIA RS-422-A Standard, *Electrical Characteristics of Balanced Voltage Digital Interface Circuits*, defines a serial interface much like RS-232. However, RS-422 uses balanced (or differential) transmission lines. Balanced transmission lines use two transmission lines for each signal. The state of each signal is represented, not by a voltage level on one line referenced to ground as in RS-232, but rather by the relative voltage of the two lines to each other. For example, the TX signal is carried on two wires, wire A and wire B. A logical 1 is represented by the voltage on line A being greater than the voltage on line B. A logical 0 is represented by the voltage on line A being less than the voltage on line B. Differential voltage transmission creates a signal that is much more immune to noise as well as voltage loss due to transmission line effects. Thus, you can use RS-422 for much longer distances

(up to 4,000 ft.) and much greater transmission speeds (up to 10 Mb/s) than RS-232.

RS-485

RS-485, as specified in the EIA-485 Standard, *Standard for Electrical Characteristics of Generators and Receivers for Use in Balanced Digital Multipoint Systems*, expands on the RS-422 standard by increasing the number of devices you can use from 10 to 32 and by working with half-duplex bus architectures. Unlike the RS-422 standard, RS-485 addresses the issue of using multiple transmitters on the same line. RS-485 defines the electrical characteristics necessary to ensure adequate signal voltages under maximum load, short-circuit protection, and the ability to withstand multiple drivers driving conflicting signals at the same time.

Table C-1 lists the features of the RS-232, RS-422, and RS-485 standards.

Table C-1. RS-232, RS-422, and RS-485 Features

Feature	RS-232	RS-422	RS-485
Type of transmission lines	Unbalanced	Differential	Differential
Maximum number of drivers	1	1	32
Maximum number of receivers	1	10	32
Maximum cable length	50 ft.	4,000 ft.	4,000 ft.
Maximum data rate	20 kb/s	10 Mb/s	10 Mb/s
Maximum CMV	± 25 V	± 7 V	+12 to -7 V
Driver output	5 to 25 V	2 to 6 V	1.5 to 6 V
Driver load	> 3 k Ω	100 Ω	60 Ω

Serial Communication Issues

This section explains some serial communication issues, such as duplex architectures, termination methods, bias resistors, and types of connecting equipment.

Duplex Architectures

Duplex refers to the means of bandwidth usage in a serial system. The two common means of bi-directional serial communication are full duplex and half duplex. Half-duplex communication involves a transmitter and a receiver connected to each end of the same wire or pair of wires. Because the same transmission line is used for both sending and receiving data, devices cannot send data in both directions at the same time. First, one device transmits over the wire(s) to the receiver of the second device. When the first device finishes transmitting, both devices switch the connections from their transmitter to their receiver or vice versa. The device that was receiving data can then transmit over the line.

In full-duplex communication, the devices use a separate wire (or pair of wires) for simultaneous transmission in each direction. Thus, there is no need to switch between transmitting and receiving.

In a differential serial bus (for example, RS-422 or RS-485), a half-duplex system can transmit and receive over the same twisted pair of wires. Thus, half-duplex communication is often referred to as *two-wire* communications. Likewise, full-duplex communication is often referred to as *four-wire* communications, because the full-duplex system uses a separate pair of wires for communication in each direction.

Full Duplex

A typical full-duplex multidrop bus architecture involves a master-slave protocol. Only one device, the master, can control access to the bus. All other devices are slaves. Slave devices must wait for the master to give them access to the bus. In a typical full-duplex system, one transmission line connects the bus master's transmitter to all of the slave receivers. A second transmission line connects all of the slave transmitters to the bus master's receiver. Because in a differential system each transmission line is composed of two separate wires, a full-duplex system is often referred to as a four-wire system. Figure C-1 shows a typical full-duplex system.

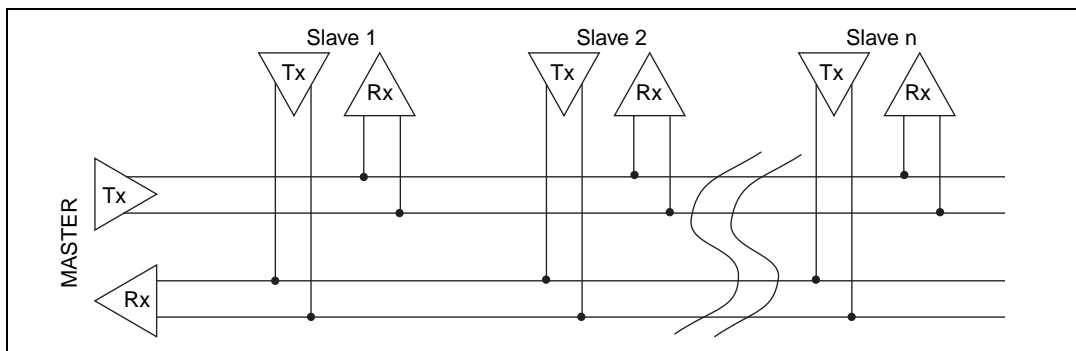

Figure C-1. Typical Full-Duplex System

Half Duplex

A typical half-duplex multidrop bus architecture also involves a master-slave protocol. In a half-duplex system, all transmitters and receivers are connected to the same transmission line. A half-duplex system is often referred to as a two-wire system. Figure C-2 shows a typical half-duplex system.

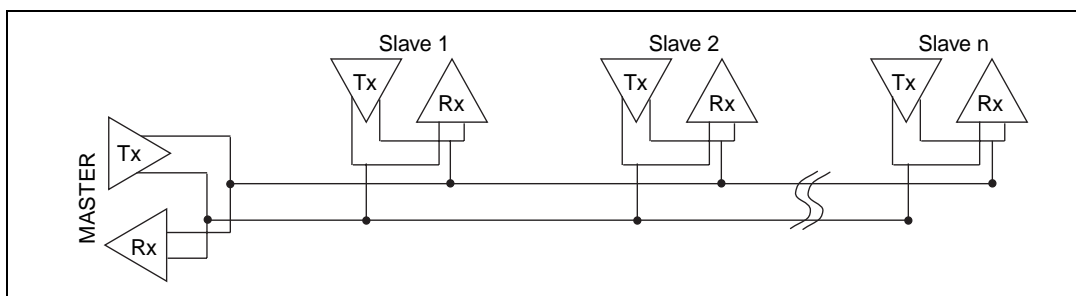

Figure C-2. Typical Half-Duplex System

Termination

Because each differential pair of wires is a transmission line, you must properly terminate the line to prevent reflections. A common method of terminating a two-wire multidrop RS-485 network is to install terminating resistors at each end of the multidrop network. If you daisy-chained multiple instruments together, you need a terminating resistor at only the first and last instruments. The terminating resistor should match the characteristic impedance of the transmission line (typically 100–120 Ω). National Instruments offers an optional DB-9 RS-485 termination

connector that contains embedded terminating resistors for easy termination.

Figure C-3 shows a multidrop network using terminating resistors.

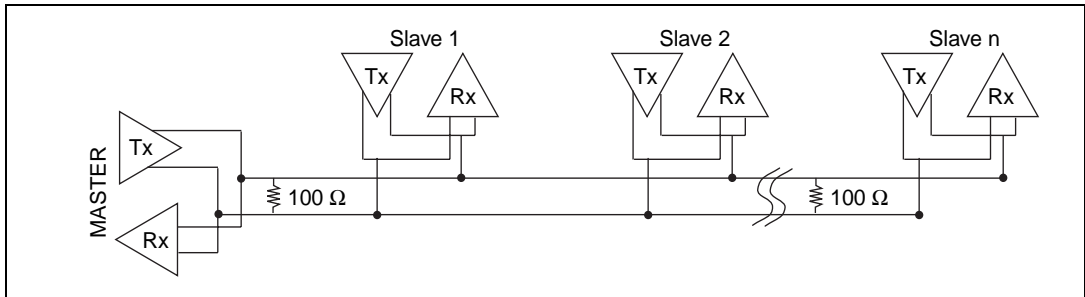

Figure C-3. Multidrop Network Using Terminating Resistors

Bias Resistors

A transmission line enters an indeterminate state if no nodes are transmitting on it. This indeterminate state can cause the receivers to receive invalid data bits from noise picked up on the cable. To prevent these data bits, you should force the transmission line into a known state. By installing two 620 Ω bias resistors at one node on the transmission line, you can create a voltage divider that forces the voltage between the differential pair to be less than 200 mV, the threshold voltage for the receiver. You should install these resistors on only one node.

Figure C-4 shows a transmission line using bias resistors.

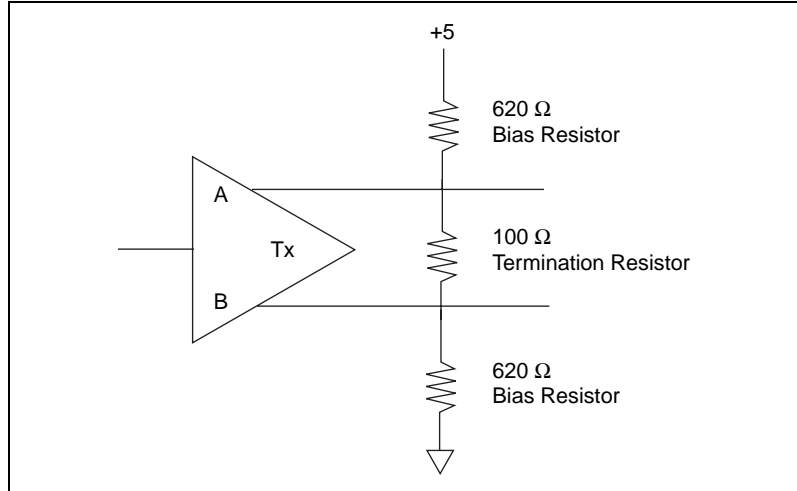

Figure C-4. Transmission Line Using Bias Resistors

Rather than using two 620 Ω resistors at one node, you can also increase the value of the resistors and put them at every node. For instance, if there are eight nodes in a system, you can use 4.7 k Ω resistors at each node to effectively achieve the same result.

DTE vs. DCE

Data Terminal Equipment (DTE) and Data Communications Equipment (DCE) were the terms used in the RS-232 specification for the types of equipment on either end of a serial connection. (A DCE is called Data Circuit-Terminating Equipment in Revision D of the RS-232 specification.) In general, DTE and DCE refer to computer equipment and modems, respectively. Because the RS-232 specification mainly involves connecting a DTE directly to a DCE and vice versa, the pinouts are defined so that cabling is simple. That is, a cable connected a computer to a modem by wiring pin 1 to pin 1, pin 2 to pin 2, and so on. This method is commonly known as *straight-through* cabling.

Figure C-5 shows straight-through cabling in a DTE-to-DCE interface.

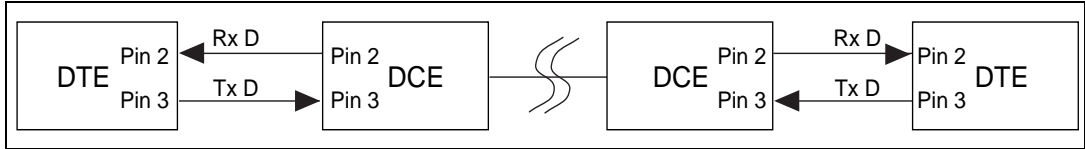

Figure C-5. Straight-Through Cabling in a DTE-to-DCE Interface

Straight-through cabling is still the standard method to connect a modem to your PC. However, because many applications use serial communication to connect two or more DTEs without modems, the cabling becomes more complicated. If two DTEs are wired together using a straight-through cable, one transmitter is connected to the other transmitter, and one receiver is connected to the other receiver. In this setup, no transmissions can occur. Thus, these applications must use a cabling scheme that connects the transmitter on one device to the receiver on the other device and vice versa. This method is known as *null-modem* cabling, because it replaces the two modems that traditional RS-232 applications would require between the two DTEs. You should use a null-modem cable to communicate from one serial port to another.

Figure C-6 shows null-modem cabling in a DTE-to-DCE interface.

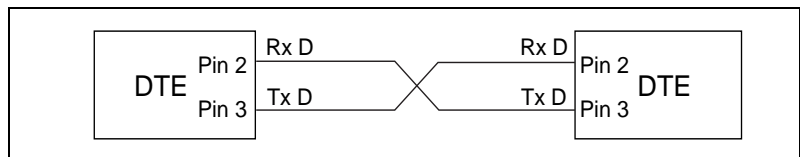

Figure C-6. Null-Modem Cabling in a DTE-to-DCE Interface

Uninstalling the Serial Hardware and Software

This appendix explains how to uninstall your serial hardware and NI Serial software.

Removing the Hardware Information

Before physically removing the serial hardware from the computer, you must remove the hardware information from the Windows 95 Device Manager. Follow these steps to uninstall the hardware.

1. Double-click the **System** icon under **Start»Settings»Control Panel**. The **System Properties** dialog box appears.
2. Select the **Device Manager** tab.
3. Click the **View devices by type** button.
4. Double-click on the **Multi-function Adapter** icon.

5. Select the National Instruments interface to remove from the list of interfaces as shown in Figure D-1.

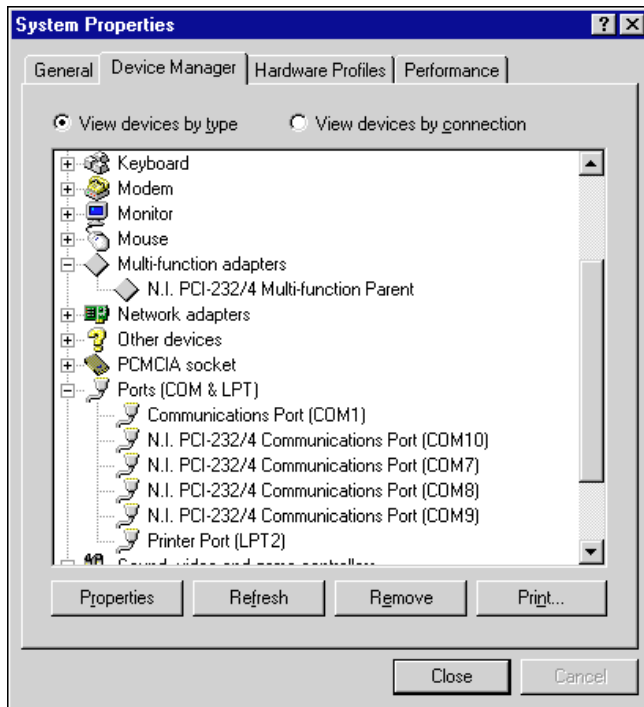

Figure D-1. Selecting an Interface to Uninstall

6. Click the **Remove** button.
7. In the **Confirm Device Removal** dialog box, click on the **OK** button to remove this interface or click on **Cancel** to cancel your request.

Uninstalling the NI Serial Software

Before uninstalling the software, you should remove all serial port information from the Windows 95 Device Manager, as described in the previous section. You do not need to shut down Windows 95 before uninstalling the software.

Complete the following steps to remove the NI Serial software.

1. Select **Start»Settings»Control Panel**.
2. Double-click on the **Add/Remove Programs** icon in the Control Panel to launch the Add/Remove Programs applet. A dialog box similar to the one in Figure D-2 appears. This dialog box lists the software available for removal.

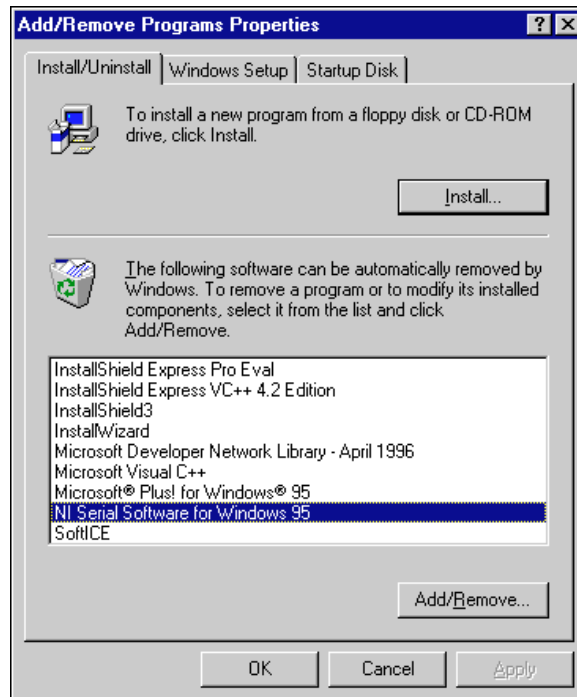

Figure D-2. Add/Remove Programs Properties Dialog Box

3. Select the serial software you want to remove, and click the **Add/Remove...** button. The uninstall program runs and removes all folders, programs, VxDs, DLLs, and registry entries associated with the NI Serial software. Figure D-3 shows the results of a successful uninstallation.

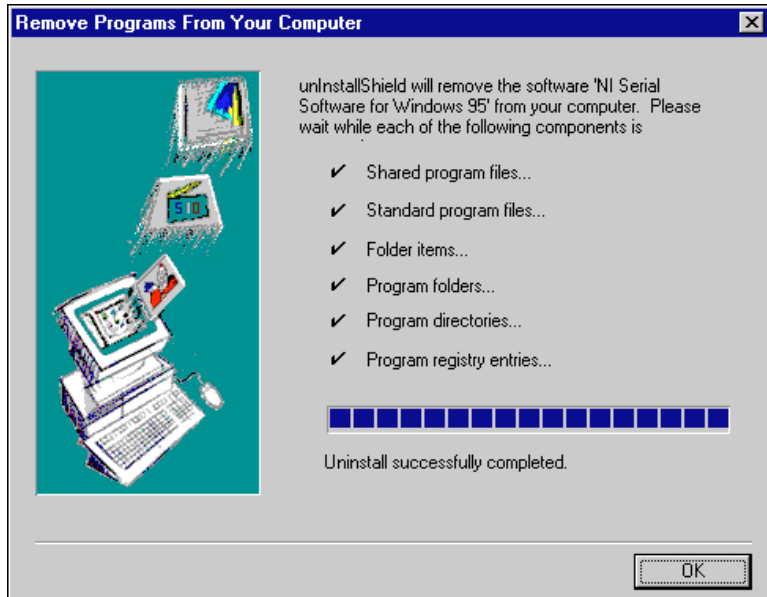

Figure D-3. Uninstallation Results

Shut down Windows 95, power off your computer, and remove the PCI serial hardware.

If you want to reinstall the hardware and software, refer to Chapter 2, [Installation and Verification](#).

Troubleshooting and Common Questions

This appendix describes how to troubleshoot problems and answers some common questions.

Freeing an Interrupt Request Level

To free an interrupt request level for the serial port, you must disable a device that is using an interrupt request level. To view the system-wide allocation of interrupt request resources and remove a device, perform the following steps.

1. Select **Start»Settings»Control Panel**.
2. Double-click on the **System** icon.
3. Select the **Device Manager** tab.
4. Double-click on the **Computer** icon at the top of the Device Manager list of devices.
5. Click on the **View Resources** tab.
6. Select the **Interrupt Request (IRQ)** button. By scanning through the list of interrupt request settings, you can determine which devices are using which interrupt request levels.
7. When you have located a device which you are not currently using, click **Cancel** to exit the **Computer Properties** window.
8. Double-click on the icon for the device in the Device Manager list of devices. In the **Device usage** field at the bottom of the **General** page, a checkmark appears to the left of the current configuration, usually **Original Configuration (Current)**.
9. Click on the checkbox to remove the checkmark.
10. Make sure that **Use automatic settings** is unchecked on the **Resources** page, then click on **OK**.
11. Restart Windows 95 so it can correctly assign resources to the serial port. Then refer to the *Verify the Hardware Resources* section of Chapter 2, *Installation and Verification*.

Selecting Conflict-Free Resources

When the resources shown under the Device Manager indicate a conflict with another device, you can often correct the problem by manually selecting conflict-free resources. Follow these steps to manually change the resources of an NI serial port.

1. Select **Start»Settings»Control Panel**.
2. Double-click on the **System** icon.
3. Select the **Device Manager** tab, and click the **View devices by type** button at the top of the page.
4. Double-click the **Multi-function Adapter** icon. A list of installed interfaces appears.
5. Double-click on the name of the serial interface you want to change, then click on the **Resources** tab.
6. Uncheck the **Use automatic settings** checkbox and click on the **Change Setting** button. If the system does not allow you to change settings, select the configuration that gives you a conflict-free base I/O address and interrupt level from the **Setting based on:** list box.
7. Click on **OK** to close the Device Manager. Your conflict problem should be solved.

Troubleshooting Diagnostic Messages

This section lists possible Diagnostic error messages, along with solutions:

- If the **No National Instruments serial port found** error message appears, refer to Chapter 2, [Installation and Verification](#), to follow these troubleshooting steps.
 1. Verify the hardware resources.
 2. Verify that the National Instruments serial driver is installed and not the native Windows 95 serial driver.
 3. If either the serial hardware or `niserial.vxd` file is missing, reinstall the hardware and software.
- If the utility reports fewer ports installed than it should, refer to Chapter 2, [Installation and Verification](#), and follow these troubleshooting steps.
 1. Verify the hardware resources.
 2. Verify that the National Instruments serial driver is installed and not the native Windows 95 serial driver.

3. Check the hardware installation to make sure the correct number of boards/ports are installed.
- If the **I/O address test failed, Interrupt test cannot be performed.** error message appears, verify the hardware resources as described in Chapter 2, *Installation and Verification*. If the test still fails, you probably have an I/O address conflict with legacy boards. Refer to the next section, *Resolving Resource Conflicts with Legacy Boards*.
 - If the **Interrupt test failed** error message appears, verify the hardware resources as described in Chapter 2, *Installation and Verification*. If the test still fails, you probably have an interrupt level conflict with legacy boards. Refer to the next section, *Resolving Resource Conflicts with Legacy Boards*.

Resolving Resource Conflicts with Legacy Boards

Resource conflicts typically occur when your system contains legacy boards that use resources that have not been reserved properly with the Device Manager. If a resource conflict exists, write down the resource that caused the conflict and refer to the *Microsoft Windows 95 User's Guide* for instructions on how to use the Device Manager to reserve I/O, IRQ, and DMA resources for legacy boards.

Common Questions

How can I determine which type of serial hardware I have installed?

1. Select **Start»Settings»Control Panel**.
2. Double-click on the **System** icon.
3. Select the **Device Manager** tab, and click on the **View devices by type** button at the top of the page.
4. Double-click on the **Ports (COM & LPT)** icon. A list of installed ports appears.

What do I do if the diagnostic test fails with an error?

Refer to the troubleshooting sections of this manual for specific information about what might cause the test to fail.

How can I determine which port is associated with COMx?

Refer to the section *Determine Which Physical Port Is Associated with COMx*, in Chapter 2, *Installation and Verification*.

How can I name National Instruments serial ports COM1, COM2, COM3, or COM4?

Table E-1 lists standard DOS-base addresses for serial ports.

Table E-1. Standard DOS-Based Addresses

COM Port	Base Address
COM1	3f8
COM2	2f8
COM3	3e8
COM4	2e8

In most cases, Windows 95 does not assign names COM1 through COM4 to the serial hardware. Rather, it names the ports starting with COM5. If you assign any of the base addresses in Table D-1 to a National Instruments serial port, Windows 95 automatically changes the COM port name to the corresponding one listed in this table. You do not need to change the IRQ setting for this name change to occur. To change the base address, refer to the *Selecting Conflict-Free Resources* section earlier in this appendix.

How do I change the resources assigned to the serial interface?

Because the serial interfaces are single physical devices that support multiple ports, they are registered as “multi-function adapters” in the Device Manager. Each port is a child device listed under **Ports (COM & LPT)**. Windows 95 does not allow the resources of the multi-function child devices to be changed directly.

To change the resources of ports on serial boards from within the Device Manager, you must open the **Multi-function adapters** class and double-click on the **Multi-function Parent** item that corresponds to your National Instruments serial interface. Use the **Resources** page to change the resources. Any resource changes are automatically reflected to the child devices. Figure E-1 shows the **Multi-function adapters** class in the Device Manager.

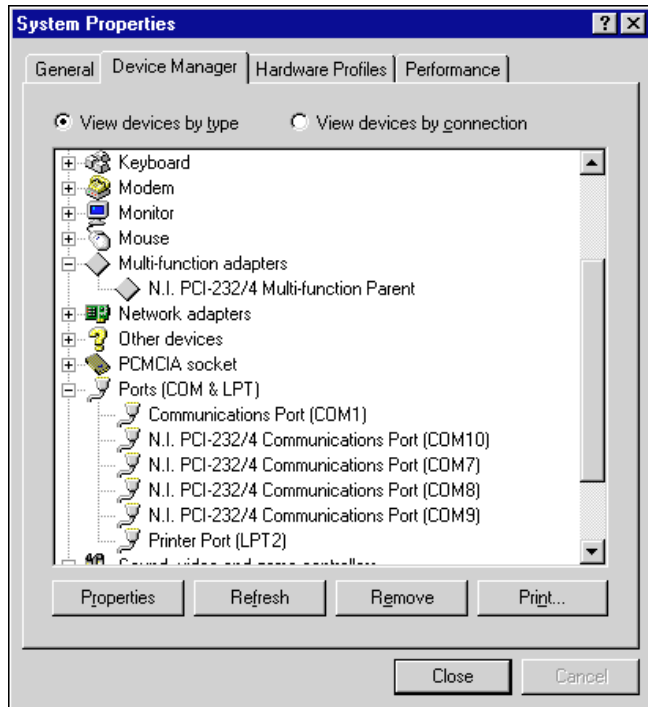

Figure E-1. Multi-Function Adapter Class in the Device Manager

How do I remove information about serial boards from the Device Manager?

Because the serial boards are single physical devices that support multiple ports, they are registered as “multi-function adapters” in the Device Manager. Each port is a child device listed under **Ports (COM & LPT)**. Windows 95 does not allow multi-function child devices to be removed directly within the Device Manager. You must open the **Multi-function adapters** class as shown in Figure D-1, select your interface, and click on the **Remove** button.

How can I determine which version of the NI-Serial software I have installed?

The Read Me file gives the version of the software. To read the file, select **Read Me** under **Start>Programs>NI Serial Software for Windows 95**.

What is the maximum baud rate supported and how can I set it?

The maximum baud rate supported is 460.8 KBaud for RS-485 and 115.2 KBaud for RS-232. You can use the Win32 function **SetCommState** and pass the actual value of the baud rate in the **BaudRate** field of the **DCB** structure.

What information should I have before I call National Instruments?

When you call National Instruments, you should have the results of the Diagnostic test. Also, make sure you have filled out the hardware and software configuration form in Appendix F, *Customer Communication*.

Customer Communication

For your convenience, this appendix contains forms to help you gather the information necessary to help us solve your technical problems and a form you can use to comment on the product documentation. When you contact us, we need the information on the Technical Support Form and the configuration form, if your manual contains one, about your system configuration to answer your questions as quickly as possible.

National Instruments has technical assistance through electronic, fax, and telephone systems to quickly provide the information you need. Our electronic services include a bulletin board service, an FTP site, a fax-on-demand system, and e-mail support. If you have a hardware or software problem, first try the electronic support systems. If the information available on these systems does not answer your questions, we offer fax and telephone support through our technical support centers, which are staffed by applications engineers.

Electronic Services

Bulletin Board Support

National Instruments has BBS and FTP sites dedicated for 24-hour support with a collection of files and documents to answer most common customer questions. From these sites, you can also download the latest instrument drivers, updates, and example programs. For recorded instructions on how to use the bulletin board and FTP services and for BBS automated information, call 512 795 6990. You can access these services at:

United States: 512 794 5422

Up to 14,400 baud, 8 data bits, 1 stop bit, no parity

United Kingdom: 01635 551422

Up to 9,600 baud, 8 data bits, 1 stop bit, no parity

France: 01 48 65 15 59

Up to 9,600 baud, 8 data bits, 1 stop bit, no parity

FTP Support

To access our FTP site, log on to our Internet host, `ftp.natinst.com`, as anonymous and use your Internet address, such as `joesmith@anywhere.com`, as your password. The support files and documents are located in the `/support` directories.

Fax-on-Demand Support

Fax-on-Demand is a 24-hour information retrieval system containing a library of documents on a wide range of technical information. You can access Fax-on-Demand from a touch-tone telephone at 512 418 1111.

E-Mail Support (Currently USA Only)

You can submit technical support questions to the applications engineering team through e-mail at the Internet address listed below. Remember to include your name, address, and phone number so we can contact you with solutions and suggestions.

support@natinst.com

Telephone and Fax Support

National Instruments has branch offices all over the world. Use the list below to find the technical support number for your country. If there is no National Instruments office in your country, contact the source from which you purchased your software to obtain support.

Country	Telephone	Fax
Australia	03 9879 5166	03 9879 6277
Austria	0662 45 79 90 0	0662 45 79 90 19
Belgium	02 757 00 20	02 757 03 11
Brazil	011 288 3336	011 288 8528
Canada (Ontario)	905 785 0085	905 785 0086
Canada (Quebec)	514 694 8521	514 694 4399
Denmark	45 76 26 00	45 76 26 02
Finland	09 725 725 11	09 725 725 55
France	01 48 14 24 24	01 48 14 24 14
Germany	089 741 31 30	089 714 60 35
Hong Kong	2645 3186	2686 8505
Israel	03 6120092	03 6120095
Italy	02 413091	02 41309215
Japan	03 5472 2970	03 5472 2977
Korea	02 596 7456	02 596 7455
Mexico	5 520 2635	5 520 3282
Netherlands	0348 433466	0348 430673
Norway	32 84 84 00	32 84 86 00
Singapore	2265886	2265887
Spain	91 640 0085	91 640 0533
Sweden	08 730 49 70	08 730 43 70
Switzerland	056 200 51 51	056 200 51 55
Taiwan	02 377 1200	02 737 4644
United Kingdom	01635 523545	01635 523154
United States	512 795 8248	512 794 5678

Technical Support Form

Photocopy this form and update it each time you make changes to your software or hardware, and use the completed copy of this form as a reference for your current configuration. Completing this form accurately before contacting National Instruments for technical support helps our applications engineers answer your questions more efficiently.

If you are using any National Instruments hardware or software products related to this problem, include the configuration forms from their user manuals. Include additional pages if necessary.

Name _____

Company _____

Address _____

Fax (____) _____ Phone (____) _____

Computer brand _____ Model _____ Processor _____

Operating system (include version number) _____

Clock speed _____ MHz RAM _____ MB Display adapter _____

Mouse ____yes ____no Other adapters installed _____

Hard disk capacity _____ MB Brand _____

Instruments used _____

National Instruments hardware product model _____ Revision _____

Configuration _____

National Instruments software product _____ Version _____

Configuration _____

The problem is: _____

List any error messages: _____

The following steps reproduce the problem: _____

Hardware and Software Configuration Form

Record the settings and revisions of your hardware and software on the line to the right of each item. Complete a new copy of this form each time you revise your software or hardware configuration, and use this form as a reference for your current configuration. Completing this form accurately before contacting National Instruments for technical support helps our applications engineers answer your questions more efficiently.

National Instruments Products

Serial Hardware and Revision Number

PCI-232 Board Revision _____

Two Port _____ Four Port _____ Eight Port _____

or

PCI-485 Board Revision _____

Two Port _____ Four Port _____

NI Software Revision Number on Distribution Disk _____

Hardware Settings

	Base I/O Address	Interrupt Level
Com1	_____	_____
Com 2	_____	_____
Com 3	_____	_____
Com 4	_____	_____
Com 5	_____	_____
Com 6	_____	_____
Com 7	_____	_____
Com 8	_____	_____
Com 9	_____	_____

Other Products

Computer make and model _____

Microprocessor _____

Clock frequency or speed _____

Type of video board installed _____

Operating system version _____

Operating system mode _____

Programming language _____

Programming language version _____

Number of Serial Ports in System

Built In _____

Adapter Cards _____

Other boards in system _____

Base I/O address of other boards _____

DMA channels of other boards _____

Interrupt level of other boards _____

Documentation Comment Form

National Instruments encourages you to comment on the documentation supplied with our products. This information helps us provide quality products to meet your needs.

Title: *Getting Started with Your PCI Serial Hardware and Software for Windows 95*

Edition Date: December 1997

Part Number: 321824A-01

Please comment on the completeness, clarity, and organization of the manual.

If you find errors in the manual, please record the page numbers and describe the errors.

Thank you for your help.

Name _____

Title _____

Company _____

Address _____

E-Mail Address _____

Phone (____) _____ Fax (____) _____

Mail to: Technical Publications
National Instruments Corporation
6504 Bridge Point Parkway
Austin, Texas 78730-5039

Fax to: Technical Publications
National Instruments Corporation
512 794 5678

Glossary

Prefix	Meanings	Value
m-	milli-	10^{-3}
c-	centi-	10^{-2}
k-	kilo-	10^3
M-	mega-	10^6

° degrees

Ω ohms

% percent

A amperes

ANSI American National Standards Institute

b bits

baud bits per second

C Celsius

COM Computer Output Microform

DB-xx subminiature D connector (where xx is the number of pins)

DCE Data Communications Equipment or Data Circuit-Terminating Equipment

DMA direct memory access

DTE Data Terminal Equipment

$\overline{\text{DTR}}$ Data Terminal Ready (where the overscore denotes that the signal is active low)

EIA Electronic Industries Association

EMI electromagnetic interference

FCC Federal Communications Commission

FIFO first-in-first-out

Glossary

ft	feet
Hz	hertz
IEEE	Institute of Electrical and Electronic Engineers
in.	inches
I/O	input/output
IRQ	interrupt request
ISA	Industry Standard Architecture
m	meters
MB	megabytes of memory
PC	personal computer
RAM	random-access memory
RX	Receive
s	seconds
TX	Transmit
$\overline{\text{TXRDY}}$	Transmit Ready (where the overscore denotes that the signal is active low)
UART	universal asynchronous receiver/transmitter
V	volts
VDC	volts direct current