

COMPREHENSIVE SERVICES

We offer competitive repair and calibration services, as well as easily accessible documentation and free downloadable resources.

SELL YOUR SURPLUS

We buy new, used, decommissioned, and surplus parts from every NI series. We work out the best solution to suit your individual needs.

 Sell For Cash  Get Credit  Receive a Trade-In Deal

OBSOLETE NI HARDWARE IN STOCK & READY TO SHIP

We stock **New, New Surplus, Refurbished, and Reconditioned** NI Hardware.



Bridging the gap between the manufacturer and your legacy test system.

 1-800-915-6216

 www.apexwaves.com

 sales@apexwaves.com

All trademarks, brands, and brand names are the property of their respective owners.

Request a Quote

 **CLICK HERE**

PCI-232-4

Serial

Getting Started with Your PCI Serial Hardware and Software for Windows 98/95

Worldwide Technical Support and Product Information

www.ni.com

National Instruments Corporate Headquarters

11500 North Mopac Expressway Austin, Texas 78759-3504 USA Tel: 512 794 0100

Worldwide Offices

Australia 03 9879 5166, Austria 0662 45 79 90 0, Belgium 02 757 00 20, Brazil 011 284 5011,
Canada (Calgary) 403 274 9391, Canada (Ontario) 905 785 0085, Canada (Québec) 514 694 8521,
China 0755 3904939, Denmark 45 76 26 00, Finland 09 725 725 11, France 01 48 14 24 24,
Germany 089 741 31 30, Greece 30 1 42 96 427, Hong Kong 2645 3186, India 91805275406,
Israel 03 6120092, Italy 02 413091, Japan 03 5472 2970, Korea 02 596 7456, Mexico (D.F.) 5 280 7625,
Mexico (Monterrey) 8 357 7695, Netherlands 0348 433466, Norway 32 27 73 00, Poland 48 22 528 94 06,
Portugal 351 1 726 9011, Singapore 2265886, Spain 91 640 0085, Sweden 08 587 895 00,
Switzerland 056 200 51 51, Taiwan 02 2377 1200, United Kingdom 01635 523545

For further support information, see the *Technical Support Resources* appendix. To comment on the documentation, send e-mail to techpubs@ni.com

Important Information

Warranty

The serial hardware is warranted against defects in materials and workmanship for a period of one year from the date of shipment, as evidenced by receipts or other documentation. National Instruments will, at its option, repair or replace equipment that proves to be defective during the warranty period. This warranty includes parts and labor.

The media on which you receive National Instruments software are warranted not to fail to execute programming instructions, due to defects in materials and workmanship, for a period of 90 days from date of shipment, as evidenced by receipts or other documentation. National Instruments will, at its option, repair or replace software media that do not execute programming instructions if National Instruments receives notice of such defects during the warranty period. National Instruments does not warrant that the operation of the software shall be uninterrupted or error free.

A Return Material Authorization (RMA) number must be obtained from the factory and clearly marked on the outside of the package before any equipment will be accepted for warranty work. National Instruments will pay the shipping costs of returning to the owner parts which are covered by warranty.

National Instruments believes that the information in this document is accurate. The document has been carefully reviewed for technical accuracy. In the event that technical or typographical errors exist, National Instruments reserves the right to make changes to subsequent editions of this document without prior notice to holders of this edition. The reader should consult National Instruments if errors are suspected. In no event shall National Instruments be liable for any damages arising out of or related to this document or the information contained in it.

EXCEPT AS SPECIFIED HEREIN, NATIONAL INSTRUMENTS MAKES NO WARRANTIES, EXPRESS OR IMPLIED, AND SPECIFICALLY DISCLAIMS ANY WARRANTY OF MERCHANTABILITY OR FITNESS FOR A PARTICULAR PURPOSE. CUSTOMER'S RIGHT TO RECOVER DAMAGES CAUSED BY FAULT OR NEGLIGENCE ON THE PART OF NATIONAL INSTRUMENTS SHALL BE LIMITED TO THE AMOUNT THEREFORE PAID BY THE CUSTOMER. NATIONAL INSTRUMENTS WILL NOT BE LIABLE FOR DAMAGES RESULTING FROM LOSS OF DATA, PROFITS, USE OF PRODUCTS, OR INCIDENTAL OR CONSEQUENTIAL DAMAGES, EVEN IF ADVISED OF THE POSSIBILITY THEREOF. This limitation of the liability of National Instruments will apply regardless of the form of action, whether in contract or tort, including negligence. Any action against National Instruments must be brought within one year after the cause of action accrues. National Instruments shall not be liable for any delay in performance due to causes beyond its reasonable control. The warranty provided herein does not cover damages, defects, malfunctions, or service failures caused by owner's failure to follow the National Instruments installation, operation, or maintenance instructions; owner's modification of the product; owner's abuse, misuse, or negligent acts; and power failure or surges, fire, flood, accident, actions of third parties, or other events outside reasonable control.

Copyright

Under the copyright laws, this publication may not be reproduced or transmitted in any form, electronic or mechanical, including photocopying, recording, storing in an information retrieval system, or translating, in whole or in part, without the prior written consent of National Instruments Corporation.

Trademarks

CVI™, LabVIEW™, National Instruments™, and ni.com™ are trademarks of National Instruments Corporation.

Product and company names mentioned herein are trademarks or trade names of their respective companies.

WARNING REGARDING USE OF NATIONAL INSTRUMENTS PRODUCTS

(1) NATIONAL INSTRUMENTS PRODUCTS ARE NOT DESIGNED WITH COMPONENTS AND TESTING FOR A LEVEL OF RELIABILITY SUITABLE FOR USE IN OR IN CONNECTION WITH SURGICAL IMPLANTS OR AS CRITICAL COMPONENTS IN ANY LIFE SUPPORT SYSTEMS WHOSE FAILURE TO PERFORM CAN REASONABLY BE EXPECTED TO CAUSE SIGNIFICANT INJURY TO A HUMAN.

(2) IN ANY APPLICATION, INCLUDING THE ABOVE, RELIABILITY OF OPERATION OF THE SOFTWARE PRODUCTS CAN BE IMPAIRED BY ADVERSE FACTORS, INCLUDING BUT NOT LIMITED TO FLUCTUATIONS IN ELECTRICAL POWER SUPPLY, COMPUTER HARDWARE MALFUNCTIONS, COMPUTER OPERATING SYSTEM SOFTWARE FITNESS, FITNESS OF COMPILERS AND DEVELOPMENT SOFTWARE USED TO DEVELOP AN APPLICATION, INSTALLATION ERRORS, SOFTWARE AND HARDWARE COMPATIBILITY PROBLEMS, MALFUNCTIONS OR FAILURES OF ELECTRONIC MONITORING OR CONTROL DEVICES, TRANSIENT FAILURES OF ELECTRONIC SYSTEMS (HARDWARE AND/OR SOFTWARE), UNANTICIPATED USES OR MISUSES, OR ERRORS ON THE PART OF THE USER OR APPLICATIONS DESIGNER (ADVERSE FACTORS SUCH AS THESE ARE HEREAFTER COLLECTIVELY TERMED "SYSTEM FAILURES"). ANY APPLICATION WHERE A SYSTEM FAILURE WOULD CREATE A RISK OF HARM TO PROPERTY OR PERSONS (INCLUDING THE RISK OF BODILY INJURY AND DEATH) SHOULD NOT BE RELIANT SOLELY UPON ONE FORM OF ELECTRONIC SYSTEM DUE TO THE RISK OF SYSTEM FAILURE. TO AVOID DAMAGE, INJURY, OR DEATH, THE USER OR APPLICATION DESIGNER MUST TAKE REASONABLY PRUDENT STEPS TO PROTECT AGAINST SYSTEM FAILURES, INCLUDING BUT NOT LIMITED TO BACK-UP OR SHUT DOWN MECHANISMS. BECAUSE EACH END-USER SYSTEM IS CUSTOMIZED AND DIFFERS FROM NATIONAL INSTRUMENTS' TESTING PLATFORMS AND BECAUSE A USER OR APPLICATION DESIGNER MAY USE NATIONAL INSTRUMENTS PRODUCTS IN COMBINATION WITH OTHER PRODUCTS IN A MANNER NOT EVALUATED OR CONTEMPLATED BY NATIONAL INSTRUMENTS, THE USER OR APPLICATION DESIGNER IS ULTIMATELY RESPONSIBLE FOR VERIFYING AND VALIDATING THE SUITABILITY OF NATIONAL INSTRUMENTS PRODUCTS WHENEVER NATIONAL INSTRUMENTS PRODUCTS ARE INCORPORATED IN A SYSTEM OR APPLICATION, INCLUDING, WITHOUT LIMITATION, THE APPROPRIATE DESIGN, PROCESS AND SAFETY LEVEL OF SUCH SYSTEM OR APPLICATION.

Compliance

FCC/Canada Radio Frequency Interference Compliance*

Determining FCC Class

The Federal Communications Commission (FCC) has rules to protect wireless communications from interference. The FCC places digital electronics into two classes. These classes are known as Class A (for use in industrial-commercial locations only) or Class B (for use in residential or commercial locations). Depending on where it is operated, this product could be subject to restrictions in the FCC rules. (In Canada, the Department of Communications (DOC), of Industry Canada, regulates wireless interference in much the same way.)

Digital electronics emit weak signals during normal operation that can affect radio, television, or other wireless products. By examining the product you purchased, you can determine the FCC Class and therefore which of the two FCC/DOC Warnings apply in the following sections. (Some products may not be labelled at all for FCC, if so the reader should then assume these are Class A devices.)

FCC Class A products only display a simple warning statement of one paragraph in length regarding interference and undesired operation. Most of our products are FCC Class A. The FCC rules have restrictions regarding the locations where FCC Class A products can be operated.

FCC Class B products display either a FCC ID code, starting with the letters **EXN**, or the FCC Class B compliance mark that appears as shown here on the right.

The curious reader can consult the FCC web site <http://www.fcc.gov> for more information.

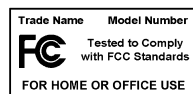

FCC/DOC Warnings

This equipment generates and uses radio frequency energy and, if not installed and used in strict accordance with the instructions in this manual and the CE Mark Declaration of Conformity**, may cause interference to radio and television reception. Classification requirements are the same for the Federal Communications Commission (FCC) and the Canadian Department of Communications (DOC).

Changes or modifications not expressly approved by National Instruments could void the user's authority to operate the equipment under the FCC Rules.

Class A

Federal Communications Commission

This equipment has been tested and found to comply with the limits for a Class A digital device, pursuant to part 15 of the FCC Rules. These limits are designed to provide reasonable protection against harmful interference when the equipment is operated in a commercial environment. This equipment generates, uses, and can radiate radio frequency energy and, if not installed and used in accordance with the instruction manual, may cause harmful interference to radio communications. Operation of this equipment in a residential area is likely to cause harmful interference in which case the user will be required to correct the interference at his own expense.

Canadian Department of Communications

This Class A digital apparatus meets all requirements of the Canadian Interference-Causing Equipment Regulations.

Cet appareil numérique de la classe A respecte toutes les exigences du Règlement sur le matériel brouilleur du Canada.

Class B

Federal Communications Commission

This equipment has been tested and found to comply with the limits for a Class B digital device, pursuant to part 15 of the FCC Rules. These limits are designed to provide reasonable protection against harmful interference in a residential installation. This equipment generates, uses and can radiate radio frequency energy and, if not installed and used in accordance with the instructions, may cause harmful interference to radio communications. However, there is no guarantee that interference will not occur in a particular installation. If this equipment does cause harmful

interference to radio or television reception, which can be determined by turning the equipment off and on, the user is encouraged to try to correct the interference by one or more of the following measures:

- Reorient or relocate the receiving antenna.
- Increase the separation between the equipment and receiver.
- Connect the equipment into an outlet on a circuit different from that to which the receiver is connected.
- Consult the dealer or an experienced radio/TV technician for help.

Canadian Department of Communications

This Class B digital apparatus meets all requirements of the Canadian Interference-Causing Equipment Regulations.

Cet appareil numérique de la classe B respecte toutes les exigences du Règlement sur le matériel brouilleur du Canada.

European Union - Compliance to EEC Directives

Readers in the EU/EEC/EEA must refer to the Manufacturer's Declaration of Conformity (DoC) for information** pertaining to the CE Mark compliance scheme. The Manufacturer includes a DoC for most every hardware product except for those bought for OEMs, if also available from an original manufacturer that also markets in the EU, or where compliance is not required as for electrically benign apparatus or cables.

* Certain exemptions may apply in the USA, see FCC Rules §15.103 **Exempted devices**, and §15.105(c). Also available in sections of CFR 47.

** The CE Mark Declaration of Conformity will contain important supplementary information and instructions for the user or installer.

Contents

About This Manual

Conventions	xi
Related Documentation.....	xii

Chapter 1

Introduction

How to Use This Manual	1-1
What You Need to Get Started	1-2
Optional Equipment	1-2
Serial Hardware Overview.....	1-2
NI Serial Software Overview.....	1-4
Time-Saving Development Tools	1-4
Using Your Serial Hardware with LabVIEW and LabWindows/CVI.....	1-5

Chapter 2

Installation and Verification

Install the Software	2-1
Install the Hardware.....	2-3
Verify the Installation	2-5
Connect the Cables	2-7
DB-9 Connector.....	2-8
Modular Jack Connector.....	2-9
DB-25 Connector.....	2-10
68-Pin Connector.....	2-12
100-Pin Connector.....	2-14
Connecting Two-Wire Devices	2-15

Chapter 3

Configuration

View or Change Communication Port Settings	3-1
Port Settings Tab.....	3-2
Bits per Second.....	3-3
Data Bits	3-3
Parity.....	3-3
Stop Bits	3-3
Flow Control.....	3-3

Advanced Port Settings	3-3
Transceiver Mode	3-4
Use FIFO Buffers	3-4
Restore Defaults	3-4

Chapter 4

Using Your Serial Hardware

General Programming Requirements	4-1
Advanced Transceiver Control for the PCI-485.....	4-1
Four-Wire Mode	4-2
Two-Wire Mode: $\overline{\text{DTR}}$ with Echo	4-2
Two-Wire Mode: $\overline{\text{DTR}}$ Controlled	4-2
Two-Wire Mode: $\overline{\text{TXRDY}}$ Auto Control.....	4-3
Setting the Transceiver Control Mode	4-3
Setting the Transceiver Mode with DeviceIoControl	4-4

Appendix A

Serial Port Information

Appendix B

Uninstalling the Hardware and Software

Appendix C

Troubleshooting and Common Questions

Appendix D

Specifications

Appendix E

Technical Support Resources

Glossary

Index

Figures

Figure 2-1.	Add/Remove Programs Properties Dialog Box.....	2-1
Figure 2-2.	NI Serial Setup Screen	2-2
Figure 2-3.	PCI Serial Board Installation.....	2-4
Figure 2-4.	Device Manager Tab for PCI Serial Board Ports	2-6
Figure 2-5.	DB-9 Connector Pin Locations	2-8
Figure 2-6.	10-Position Modular Jack Pin Locations.....	2-9
Figure 2-7.	DB-25 Connector Pin Locations	2-10
Figure 2-8.	Connecting the Cables to Your Four-Port PCI Serial Board.....	2-11
Figure 2-9.	68-Pin Connector Pin Locations.....	2-12
Figure 2-10.	100-Pin Connector Pin Locations.....	2-14
Figure 3-1.	Port Settings Tab	3-2
Figure 3-2.	Advanced Port Settings Dialog Box.....	3-3
Figure A-1.	Typical Full-Duplex System	A-4
Figure A-2.	Typical Half-Duplex System.....	A-4
Figure A-3.	Multidrop Network Using Terminating Resistors.....	A-5
Figure A-4.	Transmission Line Using Bias Resistors.....	A-6
Figure A-5.	Straight-Through Cabling in a DTE-to-DCE Interface	A-7
Figure A-6.	Null-Modem Cabling in a DTE-to-DTE Interface	A-7
Figure B-1.	Selecting an Interface to Uninstall	B-2
Figure B-2.	Add/Remove Programs Properties Dialog Box.....	B-3
Figure B-3.	Successful Uninstallation	B-4
Figure C-1.	Ports List in Device Manager.....	C-5

Tables

Table 2-1.	DB-9 Pin Descriptions.....	2-8
Table 2-2.	10-Position Modular Jack Pin Descriptions	2-9
Table 2-3.	DB-25 Pin Descriptions.....	2-10
Table 2-4.	68-Pin Connector Pin Descriptions	2-13
Table 2-5.	100-Pin Connector Pin Descriptions	2-15
Table 4-1.	Transceiver Control Modes	4-2
Table 4-2.	Transceiver Mode Control Bytes	4-4
Table 4-3.	DeviceIoControl Function Input Values	4-5
Table A-1.	RS-232, RS-422, and RS-485 Features	A-1
Table C-1.	Standard DOS-Based Addresses	C-7

About This Manual

This manual contains instructions to help you install and configure the National Instruments serial hardware and the NI Serial software for Windows 98/95. This manual includes information about the PCI-232/2, PCI-232/4, PCI-232/8, PCI-232/16, PCI-485/2, PCI-485/4, and PCI-485/8 boards.

This manual assumes that you are already familiar with Windows 98/95.

Conventions

The following conventions appear in this manual:

»

The » symbol leads you through nested menu items and dialog box options to a final action. The sequence **File»Page Setup»Options** directs you to pull down the **File** menu, select the **Page Setup** item, and select **Options** from the last dialog box.



This icon denotes a note, which alerts you to important information.



This icon denotes a caution, which advises you of precautions to take to avoid injury, data loss, or a system crash.

bold

Bold text denotes items that you must select or click on in the software, such as menu items and dialog box options. Bold text also denotes parameter names.

DTR

Signal names with an overscore, such as DTR, indicate that the signal is active low.

italic

Italic text denotes variables, emphasis, a cross reference, or an introduction to a key concept. This font also denotes text that is a placeholder for a word or value that you must supply.

monospace

Text in this font denotes text or characters that you should enter from the keyboard, sections of code, programming examples, and syntax examples. This font is also used for the proper names of disk drives, paths, directories, programs, subprograms, subroutines, device names, functions, operations, variables, filenames and extensions, and code excerpts.

monospace bold

Bold text in this font denotes the messages and responses that the computer automatically prints to the screen. This font also emphasizes lines of code that are different from the other examples.

PCI serial boards

PCI serial boards refers to all port versions of the PCI serial boards.

Related Documentation

The following documents contain information that you might find helpful as you read this manual:

- ANSI/EIA-232-D Standard, *Interface Between Data Terminal Equipment and Data Circuit-Terminating Equipment Employing Serial Binary Data Interchange*
- EIA/RS-422-A Standard, *Electrical Characteristics of Balanced Voltage Digital Interface Circuits*
- EIA-485 Standard, *Standard for Electrical Characteristics of Generators and Receivers for Use in Balanced Digital Multipoint Systems*
- *Microsoft Win32 Software Developer Kit*, Online Documentation for *Win32 Overviews*, *Win32 Reference*, and *Programmer's Guide to Windows 98/95*, Microsoft Corporation
- *NS16550AF Universal Asynchronous Receiver/Transmitter with FIFOs*, National Semiconductor
- *ST16C654 Asynchronous Receiver/Transmitter with FIFOs*, EXAR Corporation

Introduction

This chapter explains how to use this manual, lists what you need to get started and optional equipment you can order, and briefly describes the serial hardware and the NI Serial software.

How to Use This Manual

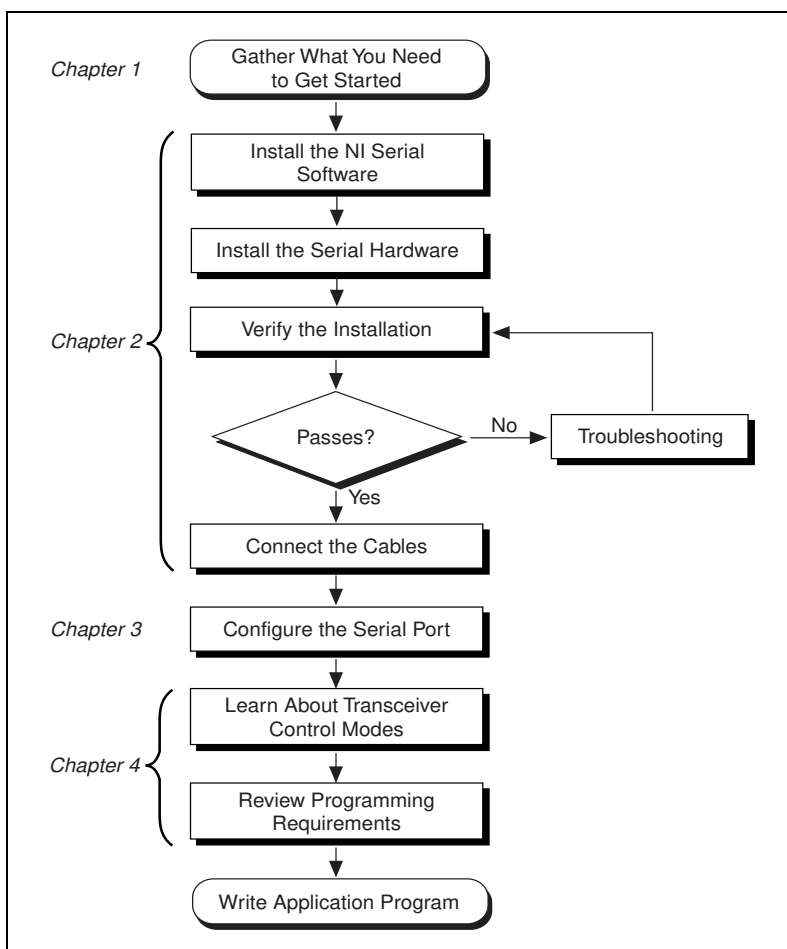

What You Need to Get Started

Before you install your serial hardware and the NI Serial software, make sure you have all of the following items:

- Windows 98/95 or higher installed on your computer
- One of the following serial boards, which is included in your kit:
 - PCI-232 (two-, four-, eight-, or sixteen-port)
 - PCI-485 (two-, four-, or eight-port)
 - PCI-232 isolated (two- or four-port)
 - PCI-485 isolated (two- or four-port)
- 3.5 in., high-density disk (1.44 MB), *NI Serial Software for Windows 98/95 and Windows NT (Setup Disk)*, which is included in your kit

Optional Equipment

For more information about ordering the following optional equipment, contact National Instruments:

- DB-9 RS-485 termination connector (PCI-485 only)
- 10-position modular jack to DB-9 cable (four-port boards only)
- 10-position modular jack to DB-25 cable (four-port boards only)
- 68-pin to DB-9 adapter cable (eight-port boards only)
- RS-232 9-pin to 9-pin null modem cable
- RS-232 9-pin to 25-pin null modem cable
- Breakout box (PCI-232/16 port-board only)

Serial Hardware Overview

The serial hardware gives you a variety of solutions for serial communication. The PCI-232 boards work with the RS-232 protocols, and the PCI-485 boards work with the RS-422 and RS-485 protocols. You can use the PCI-232 boards for serial communication up to distances of 50 ft. You can connect the PCI-485 boards to up to 31 devices using serial cable lengths up to 4,000 ft.

Additionally, the PCI serial boards are available in a two-port version (PCI-232/2 and PCI-485/2), a four-port version (PCI-232/4 and PCI-485/4), an eight-port version (PCI-232/8 and PCI-485/8), and a sixteen-port version (PCI-232/16). The two-port versions use DB-9 connectors. The four-port versions use 10-position modular jacks to provide all four connections on a single back panel. Optional cable accessories convert the 10-position modular jacks to either DB-9 or DB-25 connectors with standard pinouts. The eight-port versions use adapter cables to convert the 68-pin connector on the board to eight DB-9 connectors. The sixteen-port version uses a breakout box to convert the 100-pin connector on the board to sixteen DB-9 connectors. Throughout this manual, *PCI serial boards* refers to all port versions of the PCI serial boards.

The isolated PCI-232 and PCI-485 boards are designed for applications in harsh environments. Isolated ports provide reliable communication in situations involving ground loops from different ground levels or high common mode voltage induced on the lines in noisy environments. Non-isolated ports may not provide reliable communication in those situations. The isolation between each communication port and the host PC ensures the safe operation of the PC and the devices connected to other ports on the same board, in case of accidental high voltages on communication lines.

The PCI-485 boards support four hardware transceiver control modes for reliable communication with two- and four-wire devices. For more information about transceiver control modes, refer to Chapter 4, [Using Your Serial Hardware](#).

All serial hardware uses standard 16550-compatible UARTs (Universal Asynchronous Receiver/Transmitters) for complete compatibility with standard PC COM ports. The serial hardware contains FIFOs (First-In-First-Out) buffers to reduce susceptibility to interrupt latency for faster transmission rates. Full Plug and Play compatibility allows switchless configuration and installation. For more information about the serial hardware specifications and operating conditions, refer to Appendix D, [Specifications](#).

NI Serial Software Overview

The NI Serial software for Windows 98/95 includes a native Windows device driver that provides full interrupt-driven, buffered I/O for multiple COM ports. Using this driver, you can obtain a maximum baud rate of 460.8 KBaud on the PCI-485 and 115.2 KBaud on the PCI-232. You can also use any number of serial ports under Windows 98/95. The NI Serial software also includes a configuration utility, which is fully integrated into the Windows 98/95 Device Manager. For more information about software specifications, refer to Appendix D, *Specifications*.

The NI Serial software includes the following components:

- Device driver
- Diagnostic utility
- Configuration utility

The NI Serial software supports all National Instruments serial hardware, including the AT, PCI, PXI/CompactPCI, and PCMCIA versions.

Time-Saving Development Tools

Your kit includes the NI Serial software for Windows 98/95. In addition, you can order the LabWindows/CVI or LabVIEW software from National Instruments to speed your application development time and make it easier to communicate with your instruments.

LabVIEW is an easy-to-use, graphical programming environment you can use to acquire data from thousands of different instruments, including IEEE 488.2 devices, VXI devices, serial devices, PLCs, and plug-in data acquisition boards. After you have acquired raw data, you can convert it into meaningful results using the powerful data analysis routines in LabVIEW. LabVIEW also comes with hundreds of instrument drivers, which dramatically reduce software development time, because you do not have to spend time programming the low-level control of each instrument.

LabWindows/CVI is similar to LabVIEW, except that it combines an interactive, easy-to-use development approach with the programming power and flexibility of compiled ANSI C code.

For ordering information, or to request free demonstration software, contact National Instruments.

Using Your Serial Hardware with LabVIEW and LabWindows/CVI

After you install your serial hardware and the NI Serial software, you can use standard serial I/O functions in LabVIEW and LabWindows/CVI with your serial interface. If you already have LabVIEW or LabWindows/CVI and want to use it with your serial hardware, refer to your LabVIEW or LabWindows/CVI documentation for information about serial I/O functions.

Installation and Verification

This chapter describes how to install the NI Serial software, serial hardware, and cables, and how to verify the installation.

Install the Software

Before you install your serial hardware, complete the following steps to install the NI Serial software for Windows 98/95:

1. Select **Start»Settings»Control Panel**.
2. Double-click on the **Add/Remove Programs** icon. A dialog box similar to the one shown in Figure 2-1 appears.



Figure 2-1. Add/Remove Programs Properties Dialog Box

3. Click on the **Install** button.
4. When prompted, insert the *NI Serial Software for Windows 98/95 and Windows NT (Setup Disk)*, and click on the **Next** button.
5. When prompted, click on the **Finish** button to install the program files from floppy disks or CD-ROM.
6. The setup wizard begins with the screen shown in Figure 2-2.

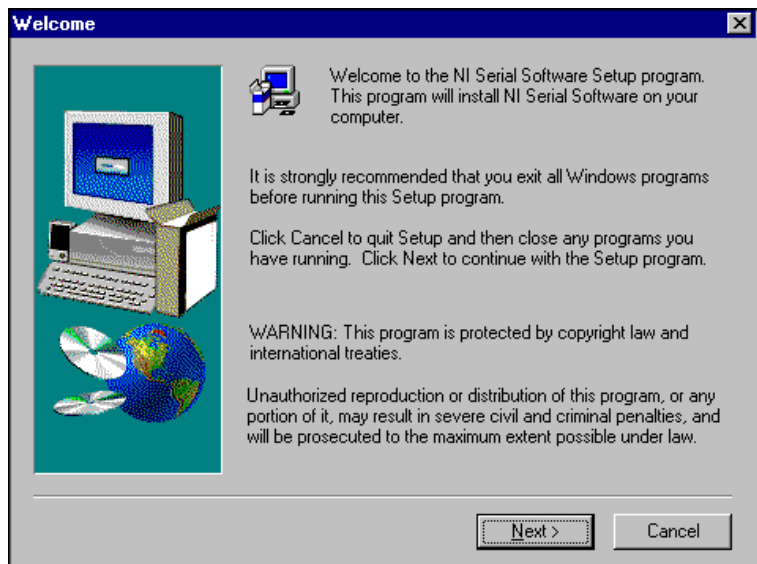

Figure 2-2. NI Serial Setup Screen

The setup wizard guides you through the necessary steps to install the NI Serial software. To exit the setup wizard at any time, click on the **Cancel** button.

7. If you need to install your hardware, or if this is your first time to install the NI Serial software for Windows 98/95, skip to the next section, [Install the Hardware](#). Otherwise, continue to step 8.
8. If your hardware is already installed, restart Windows 98/95.
9. Windows 98/95 should automatically detect your hardware and display one or more **New Hardware Found** dialog boxes. Your operating system (Windows 98/95) may show the **Windows Default Driver** option. If so, make sure the **Windows Default Driver** is selected and click on the **OK** button. If the **Windows Default Driver** option is not shown, the installation continues automatically.

If no **New Hardware Found** dialog box appears, refer to the [Forcing Windows to Detect Your Hardware](#) section in Appendix C, [Troubleshooting and Common Questions](#).

Install the Hardware



Note If you are installing a PCI-485, you might need to adjust the value of the bias resistors, depending on your application. Bias resistors are not available on the eight-port PCI-485. For more information, refer to Appendix A, [Serial Port Information](#).



Caution Before you remove your board from the package, touch the antistatic plastic package to a metal part of your system chassis to discharge electrostatic energy, which can damage several components on your serial board.

To install your PCI serial board, complete the following steps:

1. Turn off your computer. Keep the computer plugged in so that it remains grounded while you install the PCI serial board.
2. Remove the top or side cover of the computer.
3. Find an unused PCI expansion slot in your computer.
4. Remove the corresponding expansion slot cover on the back panel of the computer.
5. Touch a metal part on your chassis to discharge any static electricity.
6. Insert the PCI serial board into the slot with the serial connectors toward the opening on the back panel. Make sure that you insert the board all the way into the slot. The board might seem to click firmly into place, even though it is only part of the way in. Figure 2-3 shows how to install the PCI serial board into an expansion slot.

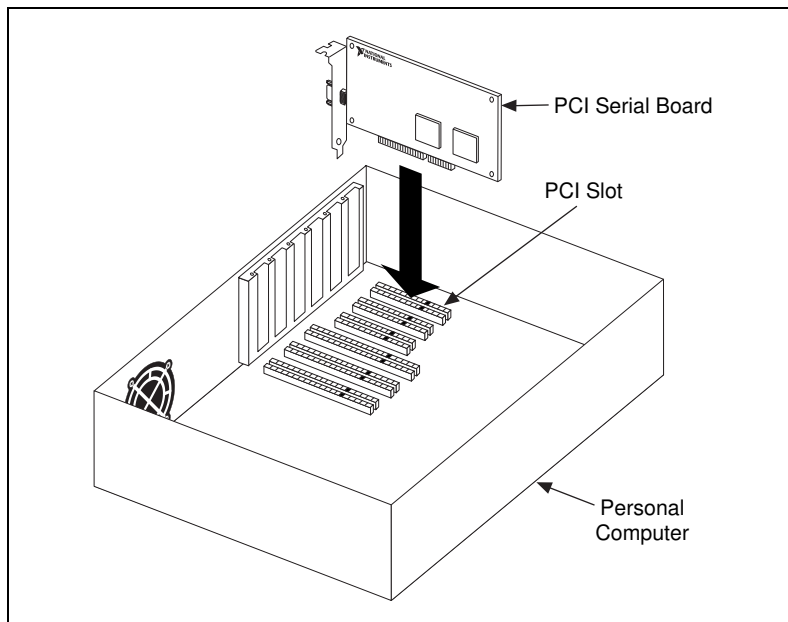

Figure 2-3. PCI Serial Board Installation

7. Screw the PCI serial board mounting bracket to the back panel mounting rail of the computer.
8. Replace the cover.
9. Turn on your computer and start Windows 98/95.
10. Windows 98/95 should automatically detect your hardware and display one or more **New Hardware Found** dialog boxes. Your operating system (Windows 98/95) may show the **Windows Default Driver** option. If so, make sure the **Windows Default Driver** is selected and click on the **OK** button. If the **Windows Default Driver** option is not shown, the installation continues automatically.

If no **New Hardware Found** dialog box appears, refer to the [Forcing Windows to Detect Your Hardware](#) section in Appendix C, *Troubleshooting and Common Questions*.

The serial hardware installation is complete. Continue to the next section, [Verify the Installation](#).

Verify the Installation

Before you verify the installation, keep in mind that the serial ports built into your computer are typically named from COM1 to COM4. Windows 98/95 typically issues port names to the ports on NI serial hardware starting with COM5, COM6, and so on. If not enough resources are available to assign to all the NI serial ports, the port with the higher COMx name is not configured.

To verify the hardware and software installation, complete the following steps:

1. Select **Start»Settings»Control Panel** and double-click on the **System** icon.
2. Click on the **Device Manager** tab and click on the **View devices by type** button.
3. Double-click on the **Ports (COM & LPT)** icon to display all of the ports.
4. Double-click on the **Multi-function adapters** icon.

The PCI serial boards are configured as devices belonging to the *multi-function adapters* class. The multi-function parent device is listed under the **Multi-function adapters** icon, and each child device is listed as a port under the **Ports (COM & LPT)** icon.

Figure 2-4 shows the Device Manager tab for serial hardware that is installed properly.

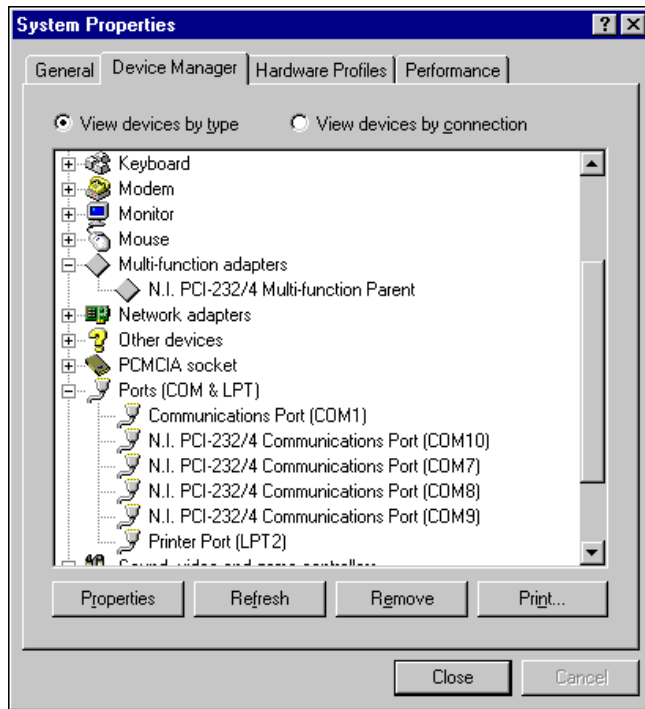

Figure 2-4. Device Manager Tab for PCI Serial Board Ports

5. Verify the hardware resources, as follows:
 - a. In the **Device Manager** tab, under **Multi-function adapters**, double-click on a serial board.
 - b. Click on the **Resources** tab. If the resources were assigned properly, the **Resources** tab shows which resources are assigned to your serial ports.
 - c. Repeat steps 6a and 6b until you have verified the resources for each board.
6. (Optional) To determine which physical port is associated with COMx, complete the following steps:
 - a. In the **Device Manager** tab, under **Ports (COM & LPT)**, double-click on the serial port (COMx).
 - b. Click on the **Port Settings** tab to display the serial number of the serial hardware and the physical port number starting at 1. For all

serial hardware, PORT1 refers to the top port, PORT2 refers to the next port down, and so on.

7. Run the diagnostic utility, as follows: select **Start»Programs»National Instruments Serial»diagnostics**.

The diagnostic utility verifies that your serial driver is installed properly, that the configuration of your hardware does not conflict with anything else in your system, and that the serial driver can communicate with your hardware correctly.

If the test is successful, your serial hardware and software are installed properly. If the test fails, refer to Appendix C, *Troubleshooting and Common Questions*, to troubleshoot the problem.

After you verify the hardware and software installation, continue to the next section, *Connect the Cables*.

Connect the Cables

For the two-port PCI serial boards, you can use the standard DB-9 connector found on most serial cables. To use the DB-9 connector with the four-port PCI serial boards, you need the 10-position modular jack to DB-9 cable, which is available from National Instruments. You can also use a DB-25 connector with the four-port PCI serial boards by ordering the 10-position modular jack to DB-25 converter cable from National Instruments. The eight-port PCI serial boards include a pig tail cable adapter, providing eight standard DB-9 connectors. The 16-port board includes a break out box, providing 16 standard DB-9 connectors.



Note To achieve the specified isolation voltage for four-port isolated PCI serial boards, use *only* the 10-position modular jack to DB-9 cable that is included in your four-port isolated PCI serial board kit.

DB-9 Connector

Figure 2-5 and Table 2-1 give the pin locations and descriptions of the DB-9 connector, which is on the two-port PCI serial board, the 10-position modular jack to DB-9 cable, the cable adapter for the eight-port board, and the DB-9 connectors to the sixteen-port breakout box.

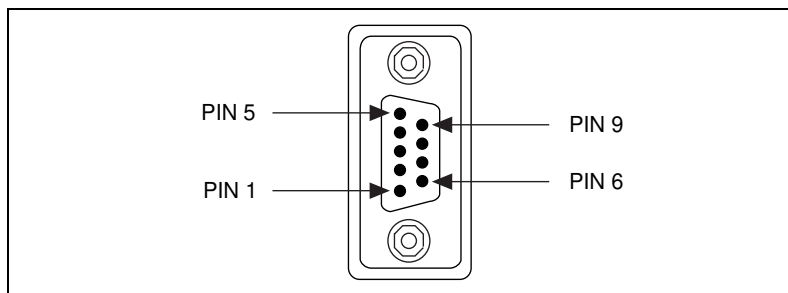

Figure 2-5. DB-9 Connector Pin Locations

Table 2-1. DB-9 Pin Descriptions

DB-9 Pin	232 Signal	485 Signal
1	DCD*	GND
2	$\overline{\text{RXD}}$	CTS+ (HSI+)
3	$\overline{\text{TXD}}$	RTS+ (HSO+)
4	DTR*	RXD+
5	GND	RXD-
6	DSR*	CTS- (HSI-)
7	RTS	RTS- (HSO-)
8	CTS	TXD+
9	RI*	TXD-

* These signals are not supported by the isolated 232 boards or ports 9-16 of the RS-232 sixteen-port board.

Modular Jack Connector

Figure 2-6 and Table 2-2 give the pin locations and descriptions of the 10-position modular jack, which is on the four-port PCI serial board.

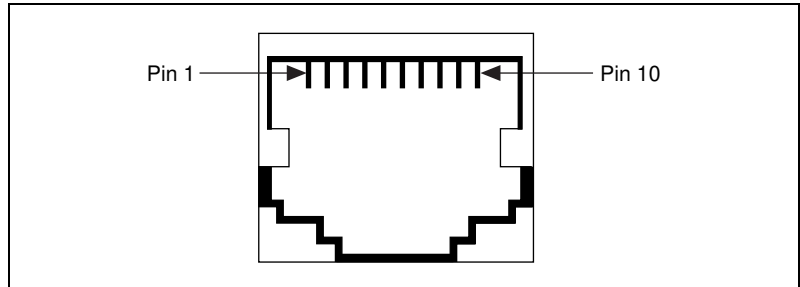

Figure 2-6. 10-Position Modular Jack Pin Locations

Table 2-2. 10-Position Modular Jack Pin Descriptions

10-Position Modular Jack Pin	232 Signal	485 Signal
10	DCD*	GND
9	$\overline{\text{RXD}}$	CTS+ (HSI+)
8	$\overline{\text{TXD}}$	RTS+ (HSO+)
7	DTR*	RXD+
6	GND	RXD-
5	DSR*	CTS- (HSI-)
4	RTS	RTS- (HSO-)
3	CTS	TXD+
2	RI*	TXD-
1	No Connect	No Connect

* These signals are not supported by the isolated 232 ports.

DB-25 Connector

Figure 2-7 and Table 2-3 give the pin locations and descriptions of the DB-25 connector, which is on the optional 10-position modular jack to DB-25 cable.

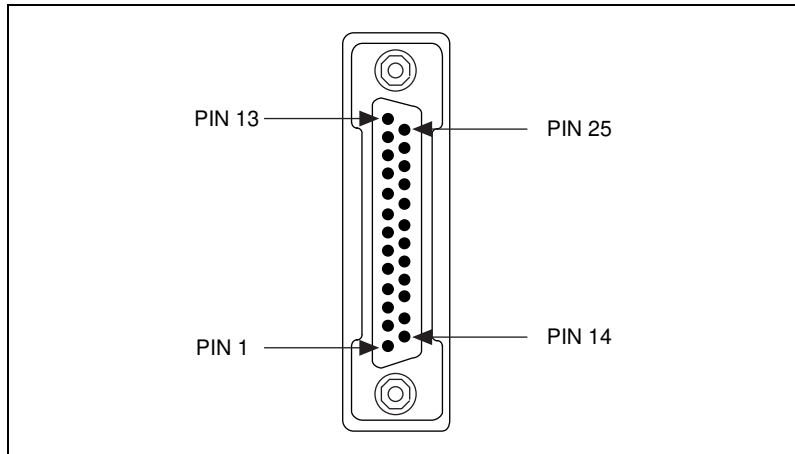

Figure 2-7. DB-25 Connector Pin Locations

Table 2-3. DB-25 Pin Descriptions

DB-25 Pin	232 Signal	485 Signal
2	$\overline{\text{TXD}}$	RTS+ (HSO+)
3	$\overline{\text{RXD}}$	CTS+ (HSI+)
4	RTS	RTS- (HSO-)
5	CTS	TXD+
6	DSR*	CTS- (HSI-)
7	GND	RXD-
8	DCD*	GND
20	DTR*	RXD+
22	RI*	TXD-

Pins not listed in this table are No Connect.
 * These signals are not supported by the isolated 232 ports.

Figure 2-8 shows how to connect the cables when you install a four-port PCI serial board.

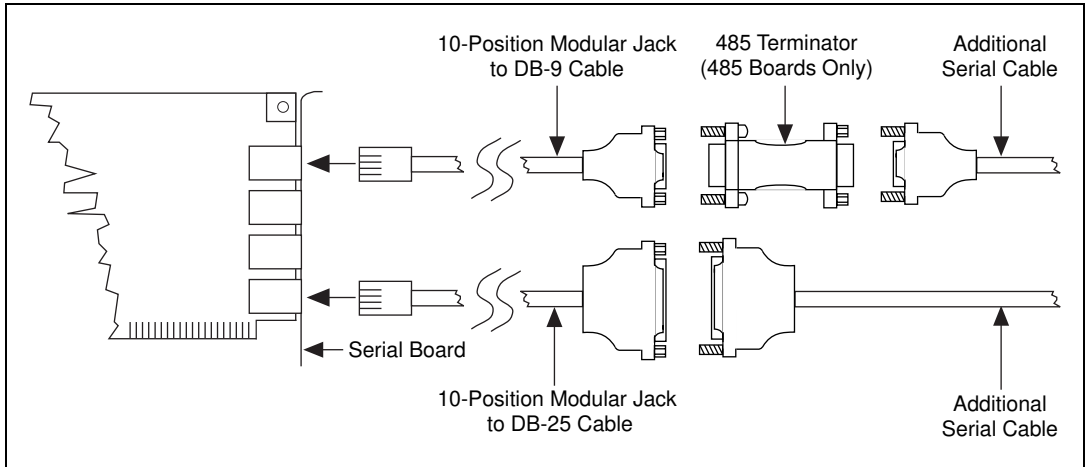

Figure 2-8. Connecting the Cables to Your Four-Port PCI Serial Board

68-Pin Connector

Figure 2-9 and Table 2-4 give the pin locations and descriptions of the 68-pin connector, which is on the eight-port PCI serial board.

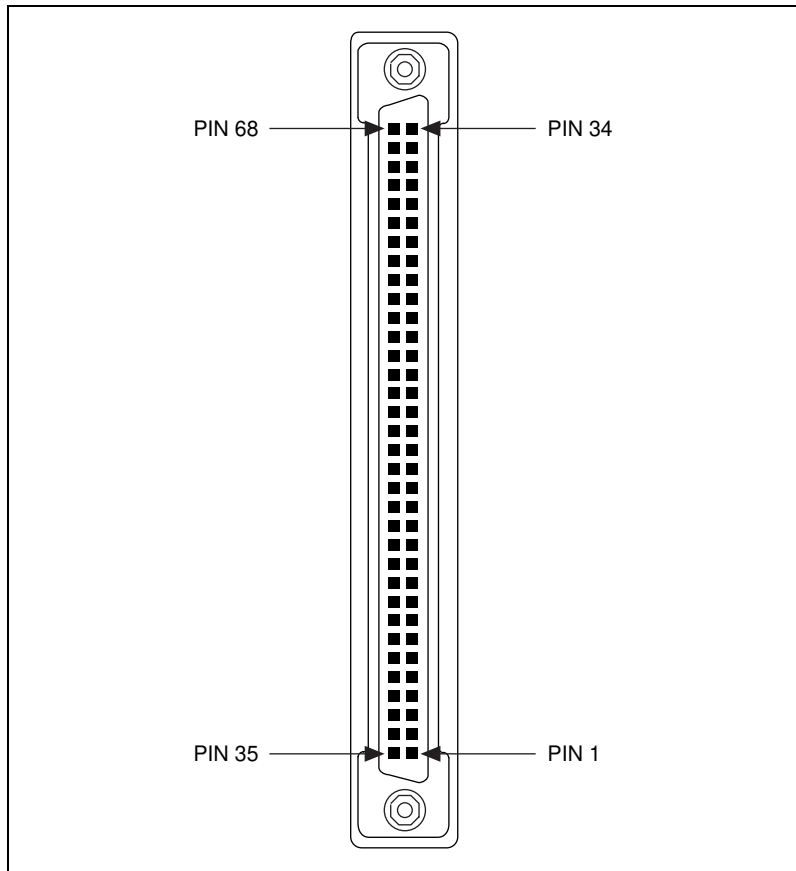

Figure 2-9. 68-Pin Connector Pin Locations

Table 2-4. 68-Pin Connector Pin Descriptions

68-Pin Connector Port								485 Signal	485 D-Sub 9 Connector	232 Signal	232 D-Sub 9 Connector
1	2	3	4	5	6	7	8				
66	57	49	40	32	23	15	6	RXD-	5	DCD	1
68	59	51	42	34	25	17	8	CTS+	2	$\overline{\text{RXD}}$	2
65	56	48	39	31	22	14	5	RTS+	3	$\overline{\text{TXD}}$	3
64	55	47	38	30	21	13	4	RXD+	4	DTR	4
60	60	43	43	26	26	9	9	GND	1	GND	5
63	54	46	37	29	20	12	3	CTS-	6	DSR	6
62	53	45	36	28	19	11	2	RTS-	7	RTS	7
61	52	44	35	27	18	10	1	TXD+	8	CTS	8
67	58	50	41	33	24	16	7	TXD-	9	RI	9

100-Pin Connector

Figure 2-10 and Table 2-5 give the pin locations and descriptions of the 100-pin connector, which is on the sixteen-port PCI serial board.

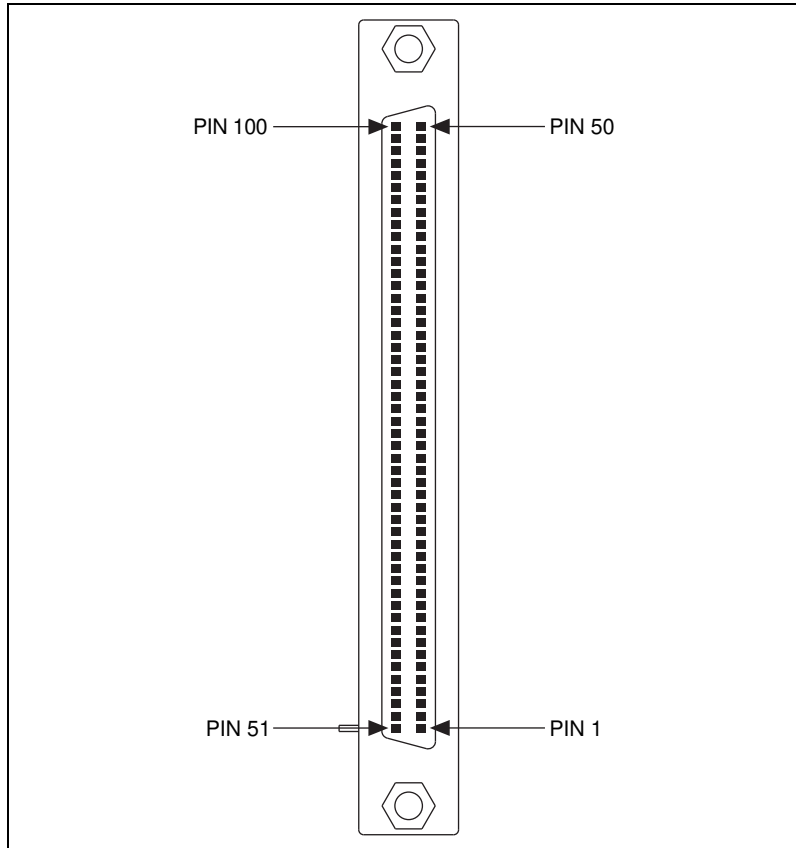

Figure 2-10. 100-Pin Connector Pin Locations

Table 2-5. 100-Pin Connector Pin Descriptions

100-Pin Connector Port																232 Signal	232 D-Sub 9 Connector
1	2	3	4	5	6	7	8	9	10	11	12	13	14	15	16		
2	46	6	42	10	38	14	34	—	—	—	—	—	—	—	—	DCD*	1
3	47	7	43	11	39	15	35	18	32	20	30	22	28	24	26	$\overline{\text{RXD}}$	2
4	48	8	44	12	40	16	36	19	33	21	31	23	29	25	27	$\overline{\text{TXD}}$	3
5	49	9	45	13	41	17	37	—	—	—	—	—	—	—	—	DTR*	4
1	1	1	1	50	50	50	50	51	51	51	51	100	100	100	100	GND	5
52	96	56	92	60	88	64	84	—	—	—	—	—	—	—	—	DSR*	6
53	97	57	93	61	89	65	85	68	82	70	80	72	78	74	76	RTS	7
54	98	58	94	62	90	66	86	69	83	71	81	73	79	75	77	CTS	8
55	99	59	95	63	91	67	87	—	—	—	—	—	—	—	—	RI*	9

* These signals are not supported on ports 9-16 of the 16-port PCI serial boards.

Connecting Two-Wire Devices

The PCI-485 boards are designed to work with either two- or four-wire devices. If you are using a two-wire device, refer to the device documentation for specific wiring instructions.

In general, half-duplex networks use a single twisted pair of wires for communication in both directions, so you must connect both the transmitter and the receiver at each end of the same pair of wires. For example, to connect an RS-485 data acquisition device to a port on your PCI-485 using half-duplex communication, you need a single twisted pair of wires. At the PCI-485, connect the TXD+ and RXD+ signals (pins 8 and 4 on a DB-9 connector, pins 5 and 20 on a DB-25 connector) together and to one wire. Connect the other end of this wire to both the TXD+ and RXD+ signals on the data acquisition device. Use the same method to connect the TXD– and RXD– signals (pins 9 and 5 on a DB-9 connector, pins 22 and 7 on a DB-25 connector) to the second wire.

For information about setting the transceiver mode for two-wire communication, refer to Chapter 4, *Using Your Serial Hardware*. For more information about duplex architectures, refer to Appendix A, *Serial Port Information*.

Configuration

This chapter describes how to view or change the communication port settings.

View or Change Communication Port Settings

The serial configuration utility is fully integrated into the Windows 98/95 Device Manager. You can use it to view or change the configuration of your serial ports.

To configure a serial port, complete the following steps:

1. Select **Start»Settings»Control Panel** and double-click on the **System** icon.
2. Click on the **Device Manager** tab and click on the **View devices by type** button.
3. Double-click on the **Ports (COM & LPT)** icon.



Note If you want your serial ports to use the names COM1, COM2, COM3, or COM4, refer to the [Common Questions](#) section of Appendix C, [Troubleshooting and Common Questions](#).

4. Double-click on the port you want to configure and refer to the following instructions:
 - To view the hardware resources assigned to the serial port, click on the **Resources** tab.
 - To view or change the port settings, click on the **Port Settings** tab. For more information about the settings, refer to the next section, [Port Settings Tab](#).
 - To change the RS-485 transceiver mode, or to enable or disable the FIFOs on the serial hardware, in the **Port Settings** tab, click on the **Advanced** button. For more information about the settings, refer to the next section, [Port Settings Tab](#).



Note Transceiver modes apply to RS-485 interfaces only. For more information about transceiver modes, refer to Chapter 4, *Using Your Serial Hardware*.

- To save your changes, click on the **OK** button. To exit without saving the changes, click on the **Cancel** button.

Port Settings Tab

In the **Port Settings** tab, you can change any of the settings by clicking on the arrow button to the right of a field. When you click on the arrow button, a list of valid values for that field appears and you can select the desired setting from the list. Figure 3-1 shows the **Port Settings** tab.

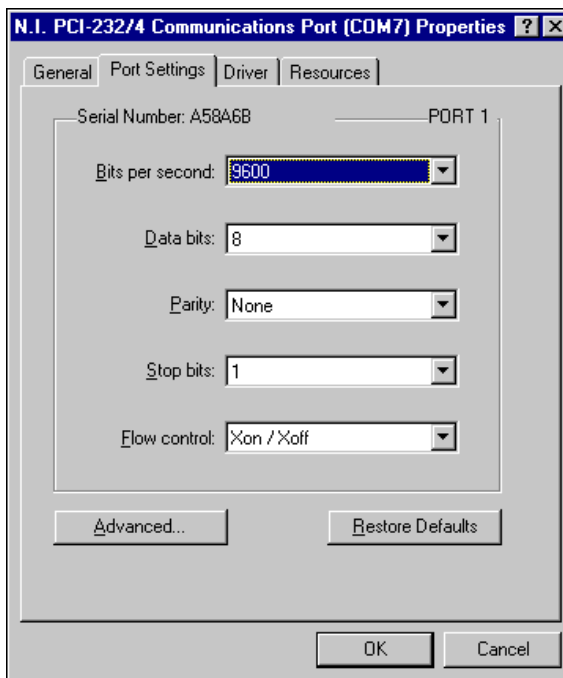

Figure 3-1. Port Settings Tab

The following sections describe the options you can set in the Device Manager **Port Settings** tab.

Bits per Second

Bits per second, or baud rate, is the speed for a serial port.

Data Bits

Data bits is the number of data bits in a single serial byte.

Parity

Parity is the specification for even, odd, or no parity bits in each transmitted byte.

Stop Bits

Stop bits is the number of terminating bits on the end of each transmitted serial byte.

Flow Control

Flow control is a method for temporarily halting the stream of serial bytes to prevent overflow.

Advanced Port Settings

To view or change the advanced port settings, click on the **Advanced** button. Figure 3-2 shows the **Advanced Port Settings** dialog box.

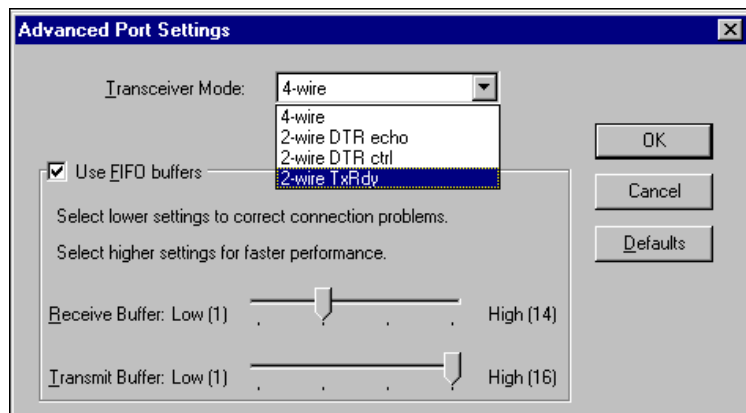

Figure 3-2. Advanced Port Settings Dialog Box

The following sections describe the advanced port setting options.

Transceiver Mode

This field shows the transceiver mode in use, and applies only to PCI-485 boards. For more information about transceiver modes, refer to Chapter 4, *Using Your Serial Hardware*.

Use FIFO Buffers

FIFO buffers are present on the 16550-compatible UARTs—one for the transmitter and one for the receiver. The **Receive Buffer** control sets the number of characters received in the FIFO before the PC is interrupted to read the data. The **Transmit Buffer** control sets the maximum number of bytes written to the FIFO in a block when the PC is interrupted to write the data. When you configure FIFO settings, consider the following points:

- You can select larger FIFO buffer sizes to reduce the number of interrupts your PC receives and therefore minimize system overhead.
- If transfer rates are high, you can lower the **Receive Buffer** value to prevent overrun errors due to interrupt latency.
- If your data sizes are small and your **Receive Buffer** value is above your data sizes, your system is less efficient. Therefore, set the **Receive Buffer** value below your data sizes.

Restore Defaults

To reset the fields to their default values at any time, click on the **Restore Defaults** button.

Using Your Serial Hardware

This chapter describes how to set the hardware transceiver control mode for your RS-485 interfaces and lists some general programming requirements.

General Programming Requirements

The NI Serial software is fully integrated into the standard Windows 98/95 communications software. NI serial ports are used like any other Windows 98/95 communications (COM) port. Windows 98/95 has standard communication functions for use within either Win16 or Win32 applications.

When you develop your application, remember that you must use the standard Microsoft Windows serial communication functions. For information about Microsoft Windows serial communication functions, refer to the *Win32 Software Development Kit* and to the *Win32 Overviews and Win32 Reference* online help.

If you have LabVIEW or LabWindows/CVI and want to use it with your serial hardware, refer to your LabVIEW or LabWindows/CVI documentation for information about serial I/O functions.

Advanced Transceiver Control for the PCI-485



Note Transceiver modes apply only to the PCI-485 boards.

The PCI-485 boards support four modes of hardware transceiver control. You can use hardware flow control to enable and disable your transmitters and receivers so that they function on different bus topologies. Table 4-1 lists the status of the transmitters and receivers under each of the transceiver control modes.

Table 4-1. Transceiver Control Modes

Mode	Transmitter	Receiver
Four-wire mode	Always enabled	Always enabled
Two-wire mode: $\overline{\text{DTR}}$ with echo	Enabled with $\overline{\text{DTR}}$ unasserted	Always enabled
Two-wire mode: $\overline{\text{DTR}}$ controlled	Enabled with $\overline{\text{DTR}}$ unasserted	Enabled with $\overline{\text{DTR}}$ asserted
Two-wire mode: $\overline{\text{TXRDY}}$ auto control	Enabled with $\overline{\text{TXRDY}}$ asserted	Enabled with $\overline{\text{TXRDY}}$ unasserted



Note Signal names with an overscore, such as $\overline{\text{DTR}}$, indicate that the signal is active low.

Four-Wire Mode

Use the four-wire mode for most full-duplex systems. In this mode, the transmitter and receiver are always enabled. This mode is the default.

Two-Wire Mode: $\overline{\text{DTR}}$ with Echo

Use this mode in half-duplex systems where the $\overline{\text{DTR}}$ (Data Terminal Ready) line must control the transmitter. In the $\overline{\text{DTR}}$ -with-echo mode, the transmitter is tri-stated when the $\overline{\text{DTR}}$ signal of the UART (Universal Asynchronous Receiver/Transmitter) is asserted. To transmit, your application must first clear the $\overline{\text{DTR}}$ bit to enable the transmitter. After the data is fully transmitted, your application once again sets the $\overline{\text{DTR}}$ bit to disable the transmitter. Because the receiver is always enabled in this mode, you not only receive packets from other devices, you also receive the packets sent from your transmitter.

Two-Wire Mode: $\overline{\text{DTR}}$ Controlled

This mode is similar to the two-wire, $\overline{\text{DTR}}$ -with-echo mode. Use this mode in half-duplex systems where the $\overline{\text{DTR}}$ line must control the transmitter. Although this mode uses the same method as the $\overline{\text{DTR}}$ -with-echo mode to control the transmitter, the hardware automatically disables the receiver whenever the transmitter is enabled. Thus, you do not receive the packets sent from your transmitter.

Two-Wire Mode: $\overline{\text{TXRDY}}$ Auto Control

In this mode, the serial hardware transparently enables the transmitter and receiver in a two-wire system. Use this mode to remove the burden of flow control from your application. By connecting the transmitter to the $\overline{\text{TXRDY}}$ (Transmit Ready) line, the hardware enables the transmitter for each byte to be transmitted. Also, the hardware disables the receiver whenever the transmitter is enabled, so you do not receive the packets sent from your transmitter.



Note When you are communicating with a two-wire device, National Instruments recommends that you use the two-wire $\overline{\text{TXRDY}}$ auto control mode. Because this mode handles the transmitter/receiver enabling for a two-wire connection in your hardware, it reduces the software overhead required to perform this operation in your application program.

For more information about serial communication in two- or four-wire modes, refer to the [Serial Communication Issues](#) section in Appendix A, [Serial Port Information](#).

Setting the Transceiver Control Mode

To set the transceiver control mode, use the Windows 98/95 Device Manager. For instructions on how to use the Device Manager, refer to Chapter 3, [Configuration](#). The mode you select in the Device Manager is automatically configured when you open a port on a serial interface.

You can also set the hardware transceiver control mode from within a DOS application. For each port you want to control, write the control byte for the mode you want to select to the scratch register of the UART. Table 4-2 shows the control bytes for each mode.

Table 4-2. Transceiver Mode Control Bytes

Transceiver Mode	Control Byte
Four-wire mode	0x00
Two-wire mode: $\overline{\text{DTR}}$ with echo	0x01
Two-wire mode: $\overline{\text{DTR}}$ controlled	0x02
Two-wire mode: $\overline{\text{TXRDY}}$ auto control	0x03

The scratch register is located at offset 7 from the base address of the port. For example, if COM2 were located at base address 0x3F8, and you want to set the PCI-485 board to two-wire mode with $\overline{\text{DTR}}$ control, you would write a 0x02 to address 0x3FF. The PCI-485 board would immediately switch to the two-wire mode with $\overline{\text{DTR}}$ control.

Setting the Transceiver Mode with DeviceIoControl

The NI Serial software extends the `DeviceIoControl` Windows function for programming the transceiver control mode. To program the transceiver control mode using `DeviceIoControl`, complete the following steps:

1. Add the following lines to your source code:

```
#include <winioctl.h>

#define IOCTL_SERIAL_SET_TRANSCEIVER_MODE
CTL_CODE(FILE_DEVICE_SERIAL_PORT, 37,
METHOD_BUFFERED, FILE_ANY_ACCESS)
```
2. Use the Win32 function `DeviceIoControl`, as follows:
 - a. Use the defined control code value listed in step 1 to set the transceiver mode.
 - b. Use the input buffer values (unsigned long) listed in Table 4-3 for programming different transceiver modes.

Table 4-3. DeviceIoControl Function Input Values

Transceiver Mode	DeviceIoControl Function Input Value
Four-wire mode	128
Two-wire mode: $\overline{\text{DTR}}$ with echo	129
Two-wire mode: $\overline{\text{DTR}}$ controlled	130
Two-wire mode: $\overline{\text{TXRDY}}$ auto control	131

For example, to set $\overline{\text{TXRDY}}$ two-wire auto control mode, use the following code:

```
ULONG TranceiverMode = 131;
DeviceIoControl(hDevice,
IOCTL_SERIAL_SET_TRANSCEIVER_MODE, (PVOID)
&TranceiverMode, sizeof(ULONG), lpOutBuffer,
nOutBufferSize, lpBytesReturned, lpOverlapped);
```

Serial Port Information

This appendix describes the RS-232, RS-422, and RS-485 standards and explains some of the issues involved with these types of serial communication.

Table A-1 lists the features of the RS-232, RS-422, and RS-485 standards.

Table A-1. RS-232, RS-422, and RS-485 Features

Feature	RS-232	RS-422	RS-485
Type of transmission lines	Unbalanced	Differential	Differential
Maximum number of drivers	1	1	32
Maximum number of receivers	1	10	32
Maximum cable length	50 ft	4,000 ft	4,000 ft
Maximum data rate	20 kb/s	10 Mb/s	10 Mb/s
Maximum CMV	± 25 V	± 7 V	+12 to -7 V
Driver output	5 to 25 V	2 to 6 V	1.5 to 6 V
Driver load	> 3 k Ω	100 Ω	60 Ω

RS-232

As specified in the ANSI/EIA-232-D Standard, *Interface Between Data Terminal Equipment and Data Circuit-Terminating Equipment Employing Serial Binary Data Interchange*, RS-232 standardizes serial communication between computers, and between computer terminals and modems. Most applications use the RS-232 standard to interface peripherals to personal computers. RS-232 uses transmission lines in which the state of each signal is represented by referencing the voltage level of a single line to ground. RS-232 was designed for serial communication up to

distances of 50 ft and with data rates up to 20 kb/s. However, because of improvements in line drivers and cabling, you can usually increase the actual performance of the bus past the limitations on speed and distance recommended in the specification.

RS-422

As specified in the EIA/RS-422-A Standard, *Electrical Characteristics of Balanced Voltage Digital Interface Circuits*, RS-422 defines a serial interface much like RS-232. However, RS-422 uses balanced (or differential) transmission lines. Balanced transmission lines use two transmission lines for each signal. The state of each signal is represented, not by a voltage level on one line referenced to ground as in RS-232, but rather by the relative voltage of the two lines to each other. For example, the TX signal is carried on two wires, wire A and wire B. A logical 1 is represented by the voltage on line A being greater than the voltage on line B. A logical 0 is represented by the voltage on line A being less than the voltage on line B. Differential voltage transmission creates a signal that is more immune to noise as well as voltage loss due to transmission line effects. Thus, you can use RS-422 for longer distances (up to 4,000 ft) and greater transmission speeds (up to 10 Mb/s) than RS-232.

RS-485

As specified in the EIA-485 Standard, *Standard for Electrical Characteristics of Generators and Receivers for Use in Balanced Digital Multipoint Systems*, RS-485 expands on the RS-422 standard by increasing the number of devices you can use from 10 to 32 and by working with half-duplex bus architectures. Unlike the RS-422 standard, RS-485 addresses the issue of using multiple transmitters on the same line. RS-485 defines the electrical characteristics necessary to ensure adequate signal voltages under maximum load, short-circuit protection. RS-485 can also withstand multiple drivers driving conflicting signals at the same time.

Serial Communication Issues

This section explains some serial communication issues, including duplex architectures, termination methods, bias resistors, and types of connecting equipment.

Duplex Architectures

Duplex refers to the means of bandwidth usage in a serial system. The two common means of bi-directional serial communication are full duplex and half duplex. Half-duplex communication involves a transmitter and a receiver connected to each end of the same wire or pair of wires. Because the same transmission line both sends and receives data, devices cannot send data in both directions at the same time. First, one device transmits over the wire(s) to the receiver of the second device. When the first device finishes transmitting, both devices switch the connections from their transmitter to their receiver, or vice versa. The device that was receiving data can then transmit over the line.

In full-duplex communication, the devices use a separate wire (or pair of wires) for simultaneous transmission in each direction. Thus, the devices do not switch between transmitting and receiving.

In a differential serial bus (such as RS-422 or RS-485), a half-duplex system transmits and receives over the same twisted pair of wires. Thus, half-duplex communication is often referred to as *two-wire* communications. Likewise, full-duplex communication is often referred to as *four-wire* communications, because the full-duplex system uses a separate pair of wires for communication in each direction.

Full Duplex

A typical full-duplex multidrop bus architecture involves a master-slave protocol. Only one device, the master, can control access to the bus. All other devices are slaves. Slave devices must wait for the master to give them access to the bus. In a typical full-duplex system, one transmission line connects the bus master transmitter to all of the slave receivers. A second transmission line connects all of the slave transmitters to the bus master receiver. Because each transmission line has two separate wires, a full-duplex system is often referred to as a four-wire system. Figure A-1 shows a typical full-duplex system.

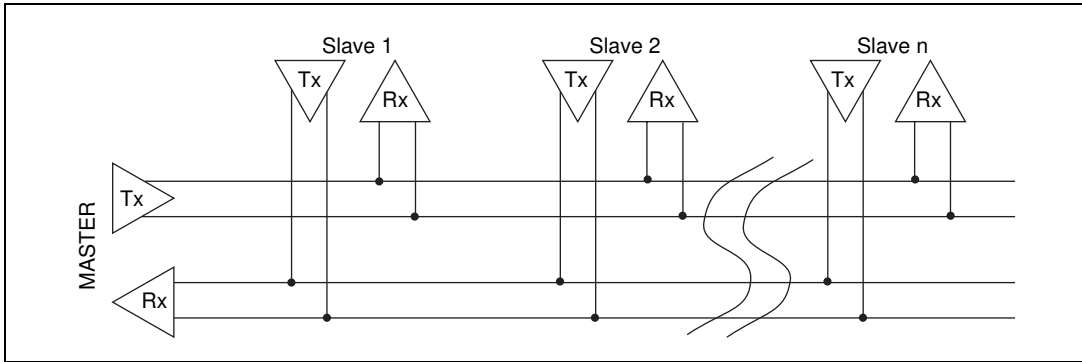

Figure A-1. Typical Full-Duplex System

Half Duplex

A typical half-duplex multidrop bus architecture also involves a master-slave protocol. However, in a half-duplex system, all transmitters and receivers are connected to the same transmission line. A half-duplex system is often referred to as a two-wire system. Figure A-2 shows a typical half-duplex system.

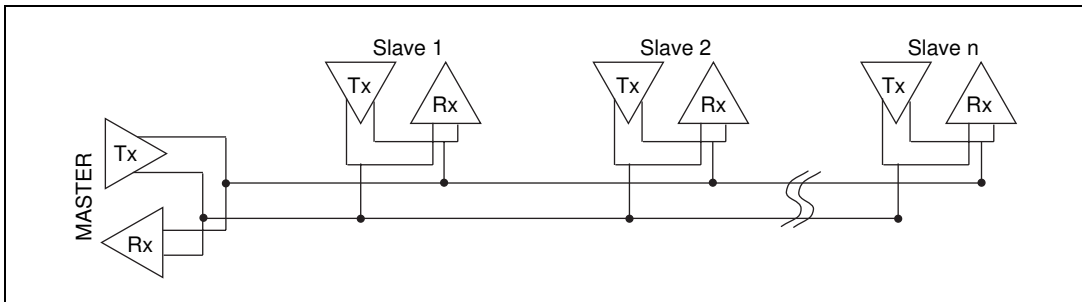

Figure A-2. Typical Half-Duplex System

Termination

Because each differential pair of wires is a transmission line, you must properly terminate the line to prevent reflections. A common method of terminating a two-wire multidrop RS-485 network is to install terminating resistors at each end of the multidrop network. If you daisy-chained multiple instruments together, you need a terminating resistor at only the first and last instruments. The terminating resistor should match the characteristic impedance of the transmission line (typically 100 to 120 Ω). You can order an optional DB-9 RS-485 termination connector that contains embedded terminating resistors for easy termination from National Instruments. For ordering information, contact National Instruments.

Figure A-3 shows a multidrop network using terminating resistors.

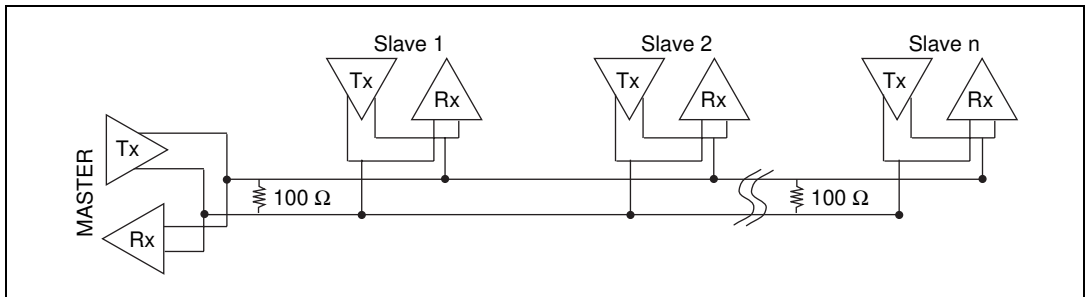

Figure A-3. Multidrop Network Using Terminating Resistors

Bias Resistors

A transmission line enters an indeterminate state if no nodes are transmitting on it. This indeterminate state can cause the receivers to receive invalid data bits from noise picked up on the cable. To prevent a line from receiving these data bits, force the transmission line into a known state. To do so, install two 620 Ω bias resistors at one node on the transmission line; doing so creates a voltage divider that forces the voltage between the differential pair to be greater than 200 mV, the threshold voltage for the receiver. You should install these resistors on only one node.



Note Bias resistors are not available on the eight-port PCI-485.

Figure A-4 shows a transmission line using bias resistors.

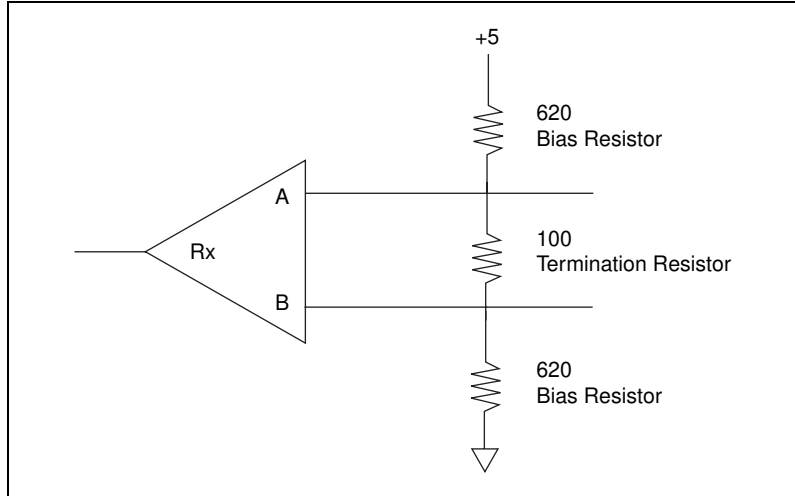

Figure A-4. Transmission Line Using Bias Resistors

On the PCI RS-485 2- and 4-port serial cards, there are four user-configurable bias resistors in front of each connector. These resistors are socketed and pre-loaded with 620 Ω resistors. They are connected to the receive signals of each port to maintain a known state when the bus is idle. The connections are made as follows:

- RXD+ and CTS- are pulled up to VCC
- RXD- and CTS+ are pulled down to GND

Rather than using two 620 Ω resistors at one node, you can increase the value of the resistors and put them at every node. For instance, if there are eight nodes in a system, you can use 4.7 k Ω resistors at each node to effectively achieve the same result.

DTE vs. DCE

In the RS-232 specification, DTE (Data Terminal Equipment) and DCE (Data Communications Equipment)¹ refer to the types of equipment on either end of a serial connection. In general, DTE and DCE refer to computer equipment and modems, respectively. Because the RS-232 specification mainly involves connecting a DTE directly to a DCE and vice versa, the pinouts are defined so that cabling is simple. That is, a cable connected a computer to a modem by wiring pin 1 to pin 1, pin 2 to pin 2, and so on. This method is known as *straight-through* cabling.

Figure A-5 shows straight-through cabling in a DTE-to-DCE interface.

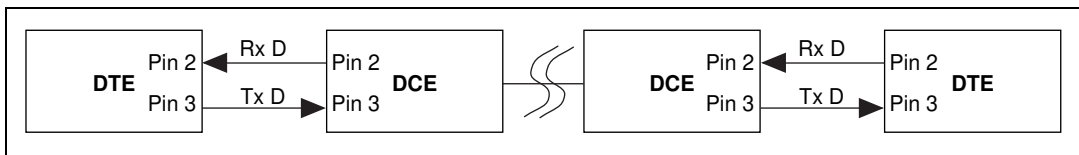

Figure A-5. Straight-Through Cabling in a DTE-to-DCE Interface

Straight-through cabling is still the standard method to connect a modem to your PC. However, because many applications use serial communication to connect two or more DTEs without modems, the cabling becomes more complicated. If two DTEs are wired together using a straight-through cable, one transmitter is connected to the other transmitter, and one receiver is connected to the other receiver. In this setup, no transmissions can occur. Thus, these applications must use a cabling scheme that connects the transmitter on one device to the receiver on the other device and vice versa. This method is known as *null-modem* cabling, because it replaces the two modems that traditional RS-232 applications would require between the two DTEs. To communicate from one serial port to another, use a null-modem cable.

Figure A-6 shows null-modem cabling in a DTE-to-DTE interface.

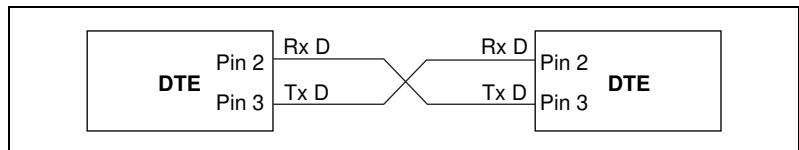

Figure A-6. Null-Modem Cabling in a DTE-to-DTE Interface

¹ In Revision D of the RS-232 specification, a DCE is a Data Circuit-Terminating Equipment.

Uninstalling the Hardware and Software

This appendix describes how to uninstall your serial hardware and the NI Serial software.

Uninstall the Hardware

Before you physically remove the serial hardware from your system, you must remove the hardware information. To do so, complete the following steps:

1. Select **Start»Settings»Control Panel** and double-click on the **System** icon.
2. Select the **Device Manager** tab and click on the **View devices by type** button.
3. Double-click on the **Multi-function adapters** icon.
4. From the **Multi-function adapters** list, select the National Instruments interface that you want to uninstall, as shown in Figure B-1.

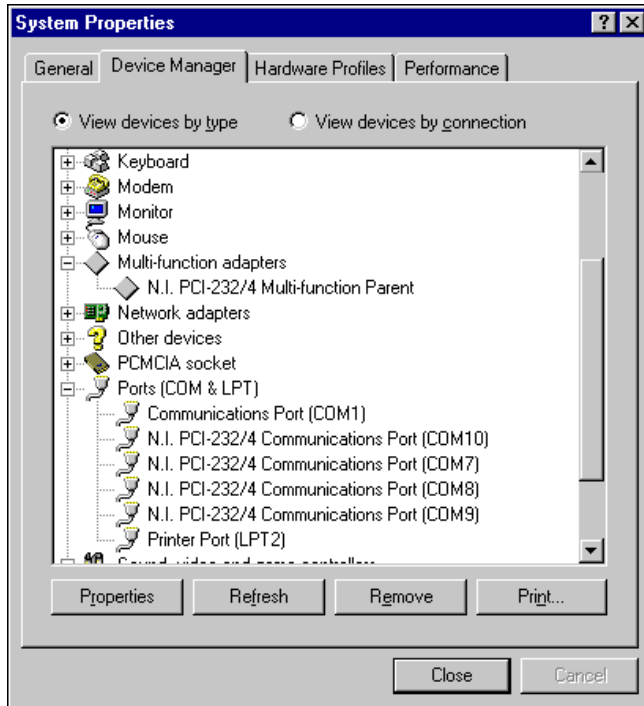

Figure B-1. Selecting an Interface to Uninstall

5. Click on the **Remove** button.
6. In the **Confirm Device Removal** dialog box, click on the **OK** button to remove the hardware information, or click on the **Cancel** button to cancel your request.

Uninstall the Software

Before you uninstall the NI Serial software, you must remove the hardware information from your system, as described in the previous section.

To uninstall the NI Serial software, complete the following steps:

1. Select **Start»Settings»Control Panel**.
2. Double-click on the **Add/Remove Programs** icon. A dialog box similar to the one shown in Figure B-2 appears. This dialog box lists the software that you can uninstall.

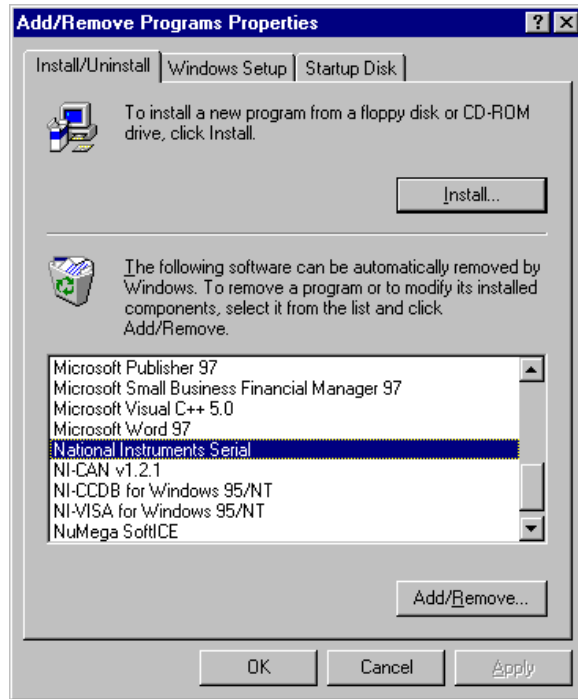

Figure B-2. Add/Remove Programs Properties Dialog Box

3. Select the NI Serial software you want to uninstall, and click on the **Add/Remove** button. The uninstallation program removes all folders, utilities, and registry entries associated with the NI Serial software. Figure B-3 shows the results of a successful uninstallation.

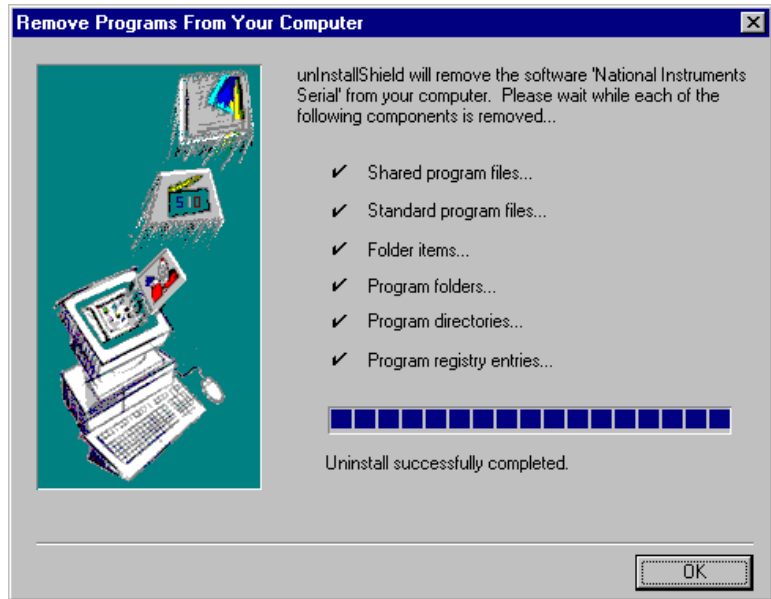

Figure B-3. Successful Uninstallation

4. Shut down Windows 98/95, turn off your computer, and physically remove the serial interfaces from your system.

The uninstallation program only removes items that the setup wizard installed. If you added anything to a directory that the setup wizard created, the uninstallation program does not delete that directory. You must remove any remaining components yourself.

If you want to reinstall the hardware and software, refer to Chapter 2, *Installation and Verification*.



Troubleshooting and Common Questions

This appendix describes how to troubleshoot problems and answers some common questions.

Freeing an Interrupt Request Level

To free an interrupt request level for your serial port, you must disable the device that is using the interrupt request level. To view the system-wide allocation of interrupt request resources and remove a device, complete the following steps:

1. Select **Start»Settings»Control Panel** and double-click on the **System** icon.
2. Click on the **Device Manager** tab.
3. Double-click on the **Computer** icon and click on the **View Resources** tab.
4. Click on the **Interrupt Request (IRQ)** button. Scan through the list of IRQ settings to determine which devices are using which interrupt request levels.
5. When you locate a device that you are not currently using, click on the **Cancel** button.
6. In the **Device Manager** tab, double-click on the icon for that device.
7. In the **Device usage** field, a checkmark appears to the left of the current configuration, usually **Original Configuration (Current)**. Click on the checkbox to remove the checkmark.
8. Click on the **Resources** tab and make sure that **Use automatic settings** is unchecked.
9. Repeat steps 7 through 9 for each unused device.
10. Click on the **OK** button to save your changes.
11. Restart Windows 98/95 to assign resources to your serial port. Then, complete step 6 in the *Verify the Installation* section of Chapter 2, *Installation and Verification*.

Selecting Conflict-Free Resources

When the Device Manager indicates a conflict with another device, you can usually correct the problem by manually selecting conflict-free resources. To do so, complete the following steps:

1. Select **Start»Settings»Control Panel** and double-click on the **System** icon.
2. Click on the **Device Manager** tab and click on the **View devices by type** button.
3. Double-click on the **Multi-function adapters** icon.
4. From the **Multi-function adapters** list, double-click on the serial interface that you want to change.
5. Click on the **Resources** tab.
6. Uncheck the **Use automatic settings** checkbox and click on the **Change Setting** button. If the system does not allow you to change the settings, select the configuration that gives you a conflict-free base address and interrupt level from the **Setting based on** list box.
7. Click on the **OK** button to save your changes.

Troubleshooting Diagnostic Messages

This section lists possible error messages returned by the diagnostic utility, along with solutions.

No National Instruments Serial Port Found

If the **No National Instruments serial port found** error message appears, complete the following steps:

1. Verify the hardware resources, as follows:
 - a. In the **Device Manager** tab, under **Multi-function adapters**, double-click on a serial board.
 - b. If a serial board is missing from the **Multi-function adapters** list, reinstall the hardware and software. For instructions on how to do so, refer to Chapter 2, *Installation and Verification*.
 - c. Click on the **Resources** tab. If the resources were assigned properly, the **Resources** tab shows which resources are assigned to your serial ports.
 - d. Check the hardware resources. If they are in conflict, refer to the previous section, *Selecting Conflict-Free Resources*.

2. In some versions of Windows 98/95, in the Device Manager, the **Driver** tab shows information about the installed driver. Make sure that the National Instruments serial driver is installed for the port.
If the serial driver is a Microsoft driver, reinstall the NI Serial software. For instructions on how to do so, refer to Chapter 2, *Installation and Verification*.
3. Make sure that the National Instruments serial driver is installed, as follows:
 - a. Locate the `niserial.vxd` file in the `\Windows\system` directory.
 - b. If the `niserial.vxd` file is missing, reinstall the hardware and software. For instructions on how to do so, refer to Chapter 2, *Installation and Verification*.

Diagnostic Utility Does Not Show All Installed Ports

If the diagnostic utility does not show all the ports you installed, complete the following steps:

1. Verify the hardware resources, as follows:
 - a. In the **Device Manager** tab, under **Multi-function adapters**, double-click on a serial board.
 - b. If a serial board is missing from the **Multi-function adapters** list, reinstall the hardware and software. For instructions on how to do so, refer to Chapter 2, *Installation and Verification*.
 - c. Click on the **Resources** tab. If the resources were assigned properly, the **Resources** tab shows which resources are assigned to your serial ports.
 - d. Check the hardware resources. If they are in conflict, refer to the previous section, *Selecting Conflict-Free Resources*.
2. In some versions of Windows 98/95, in the Device Manager, the **Driver** tab shows information about the installed driver. Make sure that the National Instruments serial driver is installed for the port.
If the serial driver is a Microsoft driver, reinstall the NI Serial software. For instructions on how to do so, refer to Chapter 2, *Installation and Verification*.
3. Physically make sure the correct number of boards/ports are installed.

Address Test Failed

If the **address test failed, Interrupt test cannot be performed** error message appears, you might have an address conflict with legacy boards in your system. To solve this problem, change the base addresses assigned to your legacy boards and refer to the [Resolving Resource Conflicts with Legacy Boards](#) section later in this appendix.

Interrupt Test Failed

If the **Interrupt test failed** error message appears, you might have an IRQ conflict with legacy boards in your system. To solve this problem, change the IRQ level assigned to your legacy boards and refer to the next section, [Resolving Resource Conflicts with Legacy Boards](#).

Resolving Resource Conflicts with Legacy Boards

Resource conflicts typically occur if your system contains legacy boards that use resources that are not reserved properly. If a resource conflict exists, write down the resource that caused the conflict and refer to the Microsoft Windows 98/95 user's guide for instructions on how to use the Device Manager to reserve I/O and IRQ resources for legacy boards.

Forcing Windows to Detect Your Hardware

If Windows 98/95 did not display the **New Hardware Found** dialog box, it did not detect your hardware. To solve this problem, complete the following steps:

1. Select **Start»Settings»Control Panel** and double-click on the **System** icon.
2. Click on the **Device Manager** tab and click on the **View devices by type** button.
3. Double-click on the **Other Devices** icon. Windows 98/95 lists the boards it does not recognize under **Other Devices**.
4. Double-click on the **Multi-function adapters** icon, where Windows 98/95 lists the parent devices of the PCI ports.

5. Select the interface that Windows 98/95 did not detect, as shown in Figure C-1.

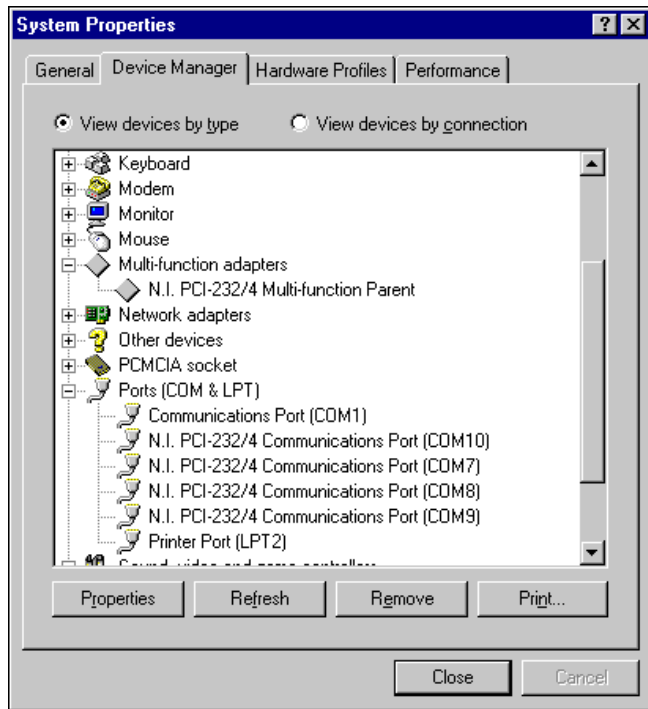

Figure C-1. Ports List in Device Manager

6. Click on the **Remove** button.
7. Click on the **OK** button to remove the serial hardware information.
8. Repeat steps 5 through 7 until you have removed all serial interfaces.
9. Click on the **Refresh** button.
10. Windows 98/95 should automatically detect your hardware and display one or more **New Hardware Found** dialog boxes. Your operating system (Windows 98/95) may show the **Windows Default Driver** option. If so, make sure the **Windows Default Driver** is selected and click on the **OK** button. If the **Windows Default Driver** option is not shown, the installation continues automatically.

Common Questions

How can I determine which type of serial hardware I have installed?

1. Select **Start»Settings»Control Panel** and double-click on the **System** icon.
2. Click on the **Device Manager** tab and click on the **View devices by type** button.
3. Double-click on the **Ports (COM & LPT)** icon to display a list of installed ports.

How can I determine which version of the NI Serial software I have installed?

The **Read Me** file gives the version of the software. To open the file, select **Start»Programs»National Instruments Serial»Read Me**.

What do I do if the diagnostic test fails with an error?

Refer to the [Troubleshooting Diagnostic Messages](#) section earlier in this appendix.

How can I determine which port is associated with COMx?

To determine which physical port is associated with COM x , complete the following steps:

1. In the **Device Manager** tab, under **Ports (COM & LPT)**, double-click on a serial port.
2. Click on the **Port Settings** tab to display the serial number of the serial hardware and the physical port number starting at 1. For all serial hardware, PORT1 refers to the top port, PORT2 refers to the next port down, and so on.

How can I name National Instruments serial ports COM1, COM2, COM3, or COM4?

To name serial ports COM1, COM2, COM3, or COM4, change the base address of the port. To do so, refer to the [Selecting Conflict-Free Resources](#) section earlier in this appendix.

When you change the base address, Windows 98/95 automatically converts it to the corresponding COM name listed in Table C-1. You do not need to change the IRQ setting for Windows 98/95 to change the name.

Table C-1. Standard DOS-Based Addresses

COM Port	Base Address
COM1	3f8
COM2	2f8
COM3	3e8
COM4	2e8

How do I change the resources assigned to the serial interface?

The PCI serial boards are configured as devices belonging to the *multi-function adapters* class. The multi-function parent device is listed under the **Multi-function adapters** icon, and each child device is listed as a port under the **Ports (COM & LPT)** icon.

To change the resources of serial ports, complete the following steps:

1. In the **Device Manager** tab, under **Multi-function adapters**, double-click on a serial interface.
2. Click on the **Resources** tab to change the resources. Your changes are automatically reflected to the child devices under **Ports (COM & LPT)**.

How do I remove information about serial boards from the Device Manager?

Refer to the [Uninstall the Hardware](#) section in Appendix B, [Uninstalling the Hardware and Software](#).

What is the maximum baud rate supported and how can I set it?

The maximum baud rate supported is 460.8 Kbaud for RS-485 and 115.2 Kbaud for RS-232. To set the baud rate, use the **SetCommState** Win32 function and pass the actual value of the baud rate in the **BaudRate** field of the **DCB** structure.

Specifications

This appendix describes the characteristics of the serial hardware, the NI Serial software, along with the recommended operating conditions.

Two-Port Boards

Dimensions..... 10.67 by 14.22 cm
(4.2 by 5.6 in.)

I/O connector..... DB-9

Power requirement (from PCI channel)

PCI-485/2

+5 VDC..... 350 mA typical
750 mA maximum

PCI-232/2

+5 VDC..... 50 mA typical
100 mA maximum
±12 VDC..... 20 mA typical
200 mA maximum

Isolated Two-Port Boards

Dimensions..... 10.67 by 14.22 cm
(4.2 by 5.6 in.)

I/O connector..... DB-9

Isolation voltage

From port to port..... 2000 Vrms/60s
From any port to host computer..... 2000 Vrms/60s

Power requirement (from PCI channel)

PCI-485/2	
+5 VDC	800 mA typical 1300 mA maximum
PCI-232/2	
+5 VDC	400 mA typical 650 mA maximum

Four-Port Boards

Dimensions	10.67 by 17.27 cm (4.2 by 6.8 in.)
I/O connector ¹	10-position modular jack
Power requirement (from PCI channel)	
PCI-485/4	
+5 VDC	700 mA typical 1300 mA maximum
PCI-232/4	
+5 VDC	70 mA typical 150 mA maximum
±12 VDC	40 mA typical 400 mA maximum

Isolated Four-Port Boards

Dimensions	10.67 by 17.27 cm (4.2 by 6.8 in.)
I/O connector ¹	10-position modular jack
Isolation voltage	
From port to port	2000 Vrms/60s
From any port to host computer	2000 Vrms/60s

¹ The four-port PCI serial boards require a cable to convert the 10-position modular jack to either DB-9 or DB-25 connectors.

Power requirement (from PCI channel)

PCI-485/4

+5 VDC.....	1000 mA typical
	1500 mA maximum

PCI-232/4

+5 VDC.....	500 mA typical
	750 mA maximum

Eight-Port Boards

Dimensions.....	10.67 by 14.48 cm (4.2 by 5.7 in.)
-----------------	---------------------------------------

I/O connector ¹	68-position, SCSI type connector
----------------------------------	----------------------------------

Power requirement (from PCI channel)

PCI-485/8

+5 VDC.....	1100 mA typical
	2000 mA maximum

PCI-232/8

+5 VDC.....	100 mA typical
	180 mA maximum
±12 VDC.....	80 mA typical
	800 mA maximum

Sixteen-Port Boards

Dimensions.....	10.67 by 17.52 cm (4.2 by 6.9 in.)
-----------------	---------------------------------------

I/O connector ²	100-position, SCSI type connector
----------------------------------	--------------------------------------

Power requirement (from PCI channel)

PCI-232/16

+5 VDC.....	250 mA typical
	500 mA maximum

¹ The eight-port PCI serial boards require a cable, which is included in your kit, to convert the 68-position connector to eight DB-9 connectors.

² The sixteen-port PCI serial boards require a breakout box, which is included in your kit, to separate the 100-position connector to sixteen DB-9 connectors.

Environmental Characteristics

Operating environment

Component temperature0 to 70 °C

Relative humidity10% to 90%, noncondensing

Storage environment

Temperature.....-40 to 120 °C

Relative humidity5% to 90%, noncondensing

EMI.....FCC Class A Certified

Software Characteristics

Maximum serial transfer rate¹

RS-485.....460,800 bps

RS-232.....115,200 bps

Space required for NI Serial software1 MB

¹ Actual speed may vary considerably from speed shown due to system and instrumentation capabilities.

Technical Support Resources

This appendix describes the comprehensive resources available to you in the Technical Support section of the National Instruments Web site and provides technical support telephone numbers for you to use if you have trouble connecting to our Web site or if you do not have internet access.

NI Web Support

To provide you with immediate answers and solutions 24 hours a day, 365 days a year, National Instruments maintains extensive online technical support resources. They are available to you at no cost, are updated daily, and can be found in the Technical Support section of our Web site at www.ni.com/support

Online Problem-Solving and Diagnostic Resources

- **KnowledgeBase**—A searchable database containing thousands of frequently asked questions (FAQs) and their corresponding answers or solutions, including special sections devoted to our newest products. The database is updated daily in response to new customer experiences and feedback.
- **Troubleshooting Wizards**—Step-by-step guides lead you through common problems and answer questions about our entire product line. Wizards include screen shots that illustrate the steps being described and provide detailed information ranging from simple getting started instructions to advanced topics.
- **Product Manuals**—A comprehensive, searchable library of the latest editions of National Instruments hardware and software product manuals.
- **Hardware Reference Database**—A searchable database containing brief hardware descriptions, mechanical drawings, and helpful images of jumper settings and connector pinouts.
- **Application Notes**—A library with more than 100 short papers addressing specific topics such as creating and calling DLLs, developing your own instrument driver software, and porting applications between platforms and operating systems.

Software-Related Resources

- **Instrument Driver Network**—A library with hundreds of instrument drivers for control of standalone instruments via GPIB, VXI, or serial interfaces. You also can submit a request for a particular instrument driver if it does not already appear in the library.
- **Example Programs Database**—A database with numerous, non-shipping example programs for National Instruments programming environments. You can use them to complement the example programs that are already included with National Instruments products.
- **Software Library**—A library with updates and patches to application software, links to the latest versions of driver software for National Instruments hardware products, and utility routines.

Worldwide Support

National Instruments has offices located around the globe. Many branch offices maintain a Web site to provide information on local services. You can access these Web sites from www.ni.com/worldwide

If you have trouble connecting to our Web site, please contact your local National Instruments office or the source from which you purchased your National Instruments product(s) to obtain support.

For telephone support in the United States, dial 512 795 8248. For telephone support outside the United States, contact your local branch office:

Australia 03 9879 5166, Austria 0662 45 79 90 0, Belgium 02 757 00 20,
Brazil 011 284 5011, Canada (Calgary) 403 274 9391,
Canada (Ontario) 905 785 0085, Canada (Québec) 514 694 8521,
China 0755 3904939, Denmark 45 76 26 00, Finland 09 725 725 11,
France 01 48 14 24 24, Germany 089 741 31 30, Greece 30 1 42 96 427,
Hong Kong 2645 3186, India 91805275406, Israel 03 6120092,
Italy 02 413091, Japan 03 5472 2970, Korea 02 596 7456,
Mexico (D.F.) 5 280 7625, Mexico (Monterrey) 8 357 7695,
Netherlands 0348 433466, Norway 32 27 73 00, Poland 48 22 528 94 06,
Portugal 351 1 726 9011, Singapore 2265886, Spain 91 640 0085,
Sweden 08 587 895 00, Switzerland 056 200 51 51,
Taiwan 02 2377 1200, United Kingdom 01635 523545

Glossary

Prefix	Meaning	Value
p-	pico-	10^{-12}
n-	nano-	10^{-9}
μ -	micro-	10^{-6}
m-	milli-	10^{-3}
k-	kilo-	10^3
M-	mega-	10^6
G-	giga-	10^9
t-	tera-	10^{12}

°	degrees
Ω	ohms
%	percent
A	amperes
ANSI	American National Standards Institute
b	bits
B	bytes
baud	bits per second
bps	bits per second
C	Celsius
COM	Computer Output Microform; used in reference to a communication port
CTS	clear to send
DB-xx	subminiature D connector, where xx is the number of pins
DCD	data carrier detect
DCE	data communications equipment or data circuit-terminating equipment

DLL	dynamic link library
DMA	direct memory access
DSR	data set ready
DTE	data terminal equipment
$\overline{\text{DTR}}$	data terminal ready—the overscore denotes that the signal is active low
duplex	the means of bandwidth usage in a serial system
EIA	Electronic Industries Association
EMI	electromagnetic interference
FCC	Federal Communications Commission
FIFO	First-In-First-Out
ft	feet
GND	ground
HSI	handshake input
HSO	handshake output
Hz	Hertz
IEEE	Institute of Electrical and Electronic Engineers
in.	inches
I/O	input/output
IRQ	interrupt request
ISA	Industry Standard Architecture
Kbaud	kilobits per second
m	meters
MB	megabytes of memory
PC	personal computer
PCI	Peripheral Components Interconnect
RAM	random-access memory
RI	ring indicator

RTS	request to send
RX	receive
$\overline{\text{RXD}}$	receive data—the overscore denotes that the signal is active low
s	seconds
SCSI	Small Computer Systems Interface
TX	transmit
$\overline{\text{TXD}}$	transmit data—the overscore denotes that the signal is active low
$\overline{\text{TXRDY}}$	transmit ready—the overscore denotes that the signal is active low
UART	Universal Asynchronous Receiver/Transmitter
V	volts
VDC	volts direct current
VXI	VME eXtensions for Instrumentation
Win16	describes a 16-bit Windows application
Win32	describes a 32-bit Windows application

Index

Numerics

- 100-pin connector, 2-14
 - pin descriptions (table), 2-15
 - pin locations (figure), 2-14
- 10-position modular jack, 2-9
 - pin descriptions (table), 2-9
 - pin locations (figure), 2-9
- 68-pin connector, 2-12
 - pin descriptions (table), 2-13
 - pin locations (figure), 2-12

A

- add/remove programs properties dialog box (figure), 2-1, B-3
- advanced port settings, 3-3
 - dialog box (figure), 3-3
 - transceiver mode, 3-4
 - using FIFO buffers, 3-4
- advanced transceiver control for the PCI-485, 4-1
 - four-wire mode, 4-2
 - setting transceiver control mode, 4-3
 - transceiver mode control bytes (table), 4-4
 - transceiver mode control modes (table), 4-2
 - two-wire mode: $\overline{\text{DTR}}$ controlled, 4-2
 - two-wire mode: $\overline{\text{DTR}}$ with Echo, 4-2
 - two-wire mode: $\overline{\text{TXRDY}}$ auto control, 4-3

B

- bias resistors, A-5
 - using in transmission line (figure), A-6
- bits per second, 3-3

C

- cable connection, 2-7
- changing communication port settings, 3-1
- changing resources assigned to serial interface, C-7
- common questions, C-6
 - changing resources assigned to serial interface, C-7
 - determining port associated with COMx, C-6
 - determining type of serial hardware installed, C-6
 - determining version of NI Serial software installed, C-6
 - diagnostic test failure, C-6
 - maximum supported baud rate, C-7
 - naming National Instruments serial ports, C-6
 - removing information about serial boards from Device Manager, C-7
- communication port settings, 3-1
 - viewing or changing, 3-1
- communication port settings configuration, 3-1
- configuration, 3-1
- conflict-free resources, C-2
 - selecting, C-2
- connecting cables, 2-7
- connecting cables to four-port PCI serial board (figure), 2-11
- connecting two-wire devices, 2-15
- conventions, *xi*

D

- data bits, 3-3
- DB-25 connector, 2-10
 - pin descriptions (table), 2-10
 - pin locations (figure), 2-10
- DB-9
 - 100-pin connector pin descriptions (figure), 2-14
 - 100-pin connector pin descriptions (table), 2-15
 - 68-pin connector pin descriptions (figure), 2-12
 - 68-pin connector pin descriptions (table), 2-13
 - connector, 2-8
 - pin descriptions (table), 2-8
 - pin locations (figure), 2-8
- DCE vs. DTE, A-7
- default restoration, 3-4
- determining port associated with COMx, C-6
- determining type of serial hardware installed, C-6
- determining version of NI Serial software installed, C-6
- development tools for saving time, 1-4
- device manager ports list (figure), C-5
- device manager tab for PCI serial board ports (figure), 2-6
- DeviceloControl, 4-4
 - input values (table), 4-5
 - setting transceiver mode with, 4-4
- diagnostic messages, C-2
 - address test failed, C-4
 - diagnostic utility does not show all installed ports, C-3
 - interrupt test failed, C-4
 - no National Instruments serial port found, C-2
 - troubleshooting, C-2
- diagnostic test failure, C-6
- DOS-based addresses (table), C-7

- DTE vs. DCE, A-7
- DTE-to-DCE interface, A-7
 - straight-through cabling in (figure), A-7
- DTE-to-DTE interface, A-7
 - null-modem cabling in (figure), A-7
- duplex architectures, A-3
 - full duplex, A-3
 - half duplex, A-4

E

- eight-port boards specifications, D-3
- environmental characteristics, D-4

F

- FIFO buffers, 3-4
- flow control, 3-3
- forcing Windows to detect hardware, C-4
- four-port boards
 - connecting cables to (figure), 2-11
 - isolated four-port boards, D-2
 - specifications, D-2
- four-wire mode, 4-2
- freeing an interrupt request level, C-1
- full duplex, A-3
 - full-duplex system (figure), A-4

G

- general programming requirements, 4-1
- getting started, 1-2
- glossary, G-1

H

- half duplex, A-4
 - half-duplex system (figure), A-4
- hardware installation, 2-3
 - getting started, 1-2
 - verification, 2-5

I

- installation
 - getting started, 1-2
 - PCI serial board installation (figure), 2-4
 - serial hardware, 2-3
 - serial software, 2-1
 - verification, 2-1
 - verifying hardware installation, 2-5
- interrupt request level, C-1
 - freeing, C-1
- introduction, 1-1
- isolated four-port boards, D-2
- isolated two-port boards, D-1

L

- LabVIEW, 1-4
 - using with serial hardware, 1-5
- LabWindows/CVI, 1-4
 - using with serial hardware, 1-5
- legacy boards, C-4
 - resolving resource conflicts with, C-4

M

- maximum supported baud rate, C-7
- modular jack connector, 2-9
 - pin descriptions (table), 2-9
 - pin locations (figure), 2-9
- multidrop network using terminating resistors (figure), A-5

N

- naming National Instruments serial ports, C-6
 - standard DOS-based addresses (table), C-7
- National Instruments Web support, E-1
- NI serial setup screen (figure), 2-2
- null-modem cabling in a DTE-to-DTE interface (figure), A-7

O

- online problem-solving and diagnostic resources, E-1
- optional equipment, 1-2
- overview of serial hardware, 1-2
- overview of serial software, 1-4

P

- parity, 3-3
- PCI serial board installation (figure), 2-4
- PCI-232, 1-2
- PCI-485, 1-2, 2-15
 - advanced transceiver control for, 4-1
 - setting transceiver control mode, 4-3
 - transceiver mode control bytes (table), 4-4
 - transceiver mode control modes (table), 4-2
 - two-wire mode: $\overline{\text{DTR}}$ controlled, 4-2
 - two-wire mode: $\overline{\text{DTR}}$ with Echo, 4-2
 - two-wire mode: $\overline{\text{TXRDY}}$ auto control, 4-3

pin descriptions

- 100-pin connector pin descriptions (figure), 2-14
- 100-pin connector pin descriptions (table), 2-15
- 68-pin connector pin descriptions (figure), 2-12
- 68-pin connector pin descriptions (table), 2-13
- DB-25
 - connector, 2-10
 - connector pin descriptions (table), 2-10
 - connector pin locations (figure), 2-10
- DB-9
 - 100-pin description (table), 2-15
 - 68-pin description (table), 2-13
 - connector, 2-8

- connector pin descriptions
 - (table), 2-8
- connector pin locations
 - (figure), 2-8
- port settings tab, 3-2
 - figure, 3-2
 - options
 - advanced port settings, 3-3
 - bits per second, 3-3
 - data bits, 3-3
 - flow control, 3-3
 - parity, 3-3
 - stop bits, 3-3
 - restore defaults button, 3-4
- ports list in device manager (figure), C-5

R

- related documentation, *xii*
- removing information about serial boards
 - from Device Manager, C-7
- resolving resource conflicts with legacy boards, C-4
- restoring defaults, 3-4
- RS-232 standard, A-1
 - features (table), A-1
- RS-422 standard, A-2
 - features (table), A-1
- RS-485 standard, A-2
 - features (table), A-1

S

- selecting an interface to uninstall (figure), B-2
- selecting conflict-free resources, C-2
- serial communication issues, A-3
 - bias resistors, A-5
 - DTE vs. DCE, A-7
 - duplex architectures, A-3
 - termination, A-5

- serial hardware
 - forcing Windows to detect, C-4
 - general programming requirements, 4-1
 - installation, 2-3
 - overview, 1-2
 - selecting an interface to uninstall
 - (figure), B-2
 - uninstalling, B-1
 - using, 4-1
 - using with LabVIEW and LabWindows/CVI, 1-5
- serial port information, A-1
- serial port names, 2-5
- serial software
 - add/remove programs properties dialog box (figure), B-3
 - installation, 2-1
 - overview, 1-4
 - successful uninstallation (figure), B-4
 - uninstalling, B-2
- setting transceiver control mode, 4-3
 - setting with DeviceloControl, 4-4
- setup screen for NI serial software (figure), 2-2
- sixteen-port boards specifications, D-3
- software characteristics, D-4
- software installation, 2-1
 - getting started, 1-2
- software-related resources, E-2
- specifications, D-1
 - eight-port boards, D-3
 - environmental characteristics, D-4
 - four-port boards, D-2
 - isolated four-port boards, D-2
 - isolated two-port boards, D-1
 - sixteen-port boards, D-3
 - software characteristics, D-4
 - two-port boards, D-1
- standard DOS-based addresses (table), C-7
- stop bits, 3-3

straight-through cabling in a DTE-to-DCE interface (figure), A-7
 successful uninstallation (figure), B-4

T

technical support resources, E-1
 telephone support, E-2
 termination, A-5

- multidrop network using terminating resistors (figure), A-5

 time-saving development tools, 1-4
 transceiver control modes (table), 4-2
 transceiver mode, 3-4

- setting with DeviceIoControl, 4-4

 transceiver mode control bytes (table), 4-4
 transmission line using bias resistors (figure), A-6
 troubleshooting, C-1

- diagnostic messages, C-2
- forcing Windows to detect your hardware, C-4
- freeing an interrupt request level, C-1
- resolving resource conflicts with legacy boards, C-4
- selecting conflict-free resources, C-2

 two-port boards specifications, D-1

- isolated two-port boards, D-1

two-wire devices, 2-15

- connecting, 2-15

 typical full-duplex system (figure), A-4
 typical half-duplex system (figure), A-4

U

uninstalling serial hardware, B-1
 uninstalling serial software, B-2
 using FIFO buffers, 3-4
 using serial hardware, 4-1
 using this manual, 1-1

V

verifying hardware installation, 2-5
 viewing or changing communication port settings, 3-1

W

Web support from National Instruments

- online problem-solving and diagnostic resources, E-1
- software-related resources, E-2

 Win32 Overviews and Win32 Reference, 4-1
 Win32 Software Development Kit, 4-1
 worldwide technical support, E-2