

COMPREHENSIVE SERVICES

We offer competitive repair and calibration services, as well as easily accessible documentation and free downloadable resources.

SELL YOUR SURPLUS

We buy new, used, decommissioned, and surplus parts from every NI series. We work out the best solution to suit your individual needs.

 Sell For Cash  Get Credit  Receive a Trade-In Deal

OBSOLETE NI HARDWARE IN STOCK & READY TO SHIP

We stock **New**, **New Surplus**, **Refurbished**, and **Reconditioned** NI Hardware.



Bridging the gap between the manufacturer and your legacy test system.

 1-800-915-6216

 www.apexwaves.com

 sales@apexwaves.com

All trademarks, brands, and brand names are the property of their respective owners.

Request a Quote

 **CLICK HERE**

PCI-232-8

SPECIFICATIONS AND FEATURES GUIDE

NI Serial Legacy Hardware

This document lists safety and compliance information for NI Serial legacy hardware, as well as physical specifications, software features, and recommended operating conditions.

Contents

NI Legacy Serial Interfaces	2
Serial Hardware Features	5
Connectors and Pinouts	6
DB-9 Male	6
DB-25 Male	7
10-Position Modular Jack (10P10C)	8
68-Pin Connector	9
100-Pin Connector	11
Cables and Accessories	13
RS-232, RS-422, and RS-485	14
RS-232, RS-422, and RS-485 Features	14
RS-232 Loopback	14
RS-232 Signals	14
RS-485/422 Loopback	15
RS-485/422 Signals	15
RS-485 Topologies	15
RS-485 Transceiver Control	16
UART Data Frame Example	16
Hardware Specifications	17
Legacy PCI Serial Hardware	17
Environmental Characteristics (for All PCI Interfaces)	20
Other Specifications	21
Safety	21
Legacy PXI Serial Hardware	22
Environmental Characteristics (for All Legacy PXI Interfaces)	26
Other Specifications	26
Safety	27
Where to Go for Support	28

NI Legacy Serial Interfaces

The PCI interfaces listed in Table 1 can only accept 5 volts.

Table 1. PCI Interfaces

PCI Interfaces	Standard	# Ports	Isolated	Max Baud (kbits/s)	Connector Type*	FIFO Size (Bytes)
PCI-232/2	RS-232	2	No	115.2	DB-9 male	64
PCI-232/4	RS-232	4	No	115.2	10P10C	64
PCI-232/8	RS-232	8	No	115.2	68-pin SCSI	64
PCI-232/16	RS-232	16	No	115.2	100-pin SCSI	64
PCI-485/2	RS-485/RS-422	2	No	460.8	DB-9 male	64
PCI-485/4	RS-485/RS-422	4	No	460.8	10P10C	64
PCI-485/8	RS-485/RS-422	8	No	460.8	68-pin SCSI	64
PCI-232i/2	RS-232	2	Yes	115.2	DB-9 male	64
PCI-232i/4	RS-232	4	Yes	115.2	10P10C	64
PCI-485i/2	RS-485/RS-422	2	Yes	460.8	DB-9 male	64
PCI-485i/4	RS-485/RS-422	4	Yes	460.8	10P10C	64

* Serial connector cables end in DB-9 male serial connectors.

Table 2. PXI Interfaces

PXI Interfaces	Standard	# Ports	Isolated	Max Baud (kbits/s)	Connector Type*	FIFO Size (Bytes)
PXI-8420/2	RS-232	2	No	115.2	DB-9 male	64
PXI-8420/4	RS-232	4	No	115.2	10P10C	64
PXI-8420/8	RS-232	8	No	115.2	68-pin SCSI	64
PXI-8420/16	RS-232	16	No	115.2	100-pin SCSI	64
PXI-8421/2	RS-485/RS-422	2	No	460.8	DB-9 male	64
PXI-8421/4	RS-485/RS-422	4	No	460.8	10P10C	64
PXI-8421/8	RS-485/RS-422	8	No	460.8	68-pin SCSI	64
PXI-8422/2	RS-232	2	Yes	115.2	DB-9 male	64
PXI-8422/4	RS-232	4	Yes	115.2	10P10C	64
PXI-8423/2	RS-485/RS-422	2	Yes	460.8	DB-9 male	64
PXI-8423/4	RS-485/RS-422	4	Yes	460.8	10P10C	64
* Serial connector cables end in DB-9 male serial connectors.						

National Instruments considers the following baud rates to be standard. NI serial hardware supports these rates up to the maximum rate specified.

300	19200
600	38400
1200	57600
2400	115200
4800	230400
9600	460800
14400	

To set the baud rate, set the VISA Baud attribute or use the Windows SetCommState function and pass the actual value of the baud rate in the **BaudRate** field of the **DCB** structure.

Refer to [Hardware Specifications](#) for supported baud rates on each board.

Serial Hardware Features

To determine which features your product supports, refer to the following table.

Table 3. Serial Hardware Features

Hardware	Adjustable FIFO Settings	Get Interface Type	RS-485 Transceiver Control	RS-485 Socketed Bias Resistors	RS-485 Programmatically Controlled Bias Resistors	RS-232 Transceiver State	RS-232 DTE/DCE Transceiver Control	Hardware Implemented Flow Control [†]		
								RTS/CTS	DTR/DSR	Xon/Xoff
PCI-232, PXI-8420, PXI-8422	✓	✓						✓		✓ [†]
PCI-485 eight port, PXI-8421 eight port	✓	✓	✓					✓		✓ [†]
All other PCI-485, PXI-8421, and PXI-8423	✓	✓	✓	✓				✓		✓ [†]

* Requires NI-Serial 3.5 or higher, for both Windows or LabVIEW RT.

[†] Not supported in LabVIEW RT.

Connectors and Pinouts

DB-9 Male

Figure 1. DB-9 Connector Pin Locations

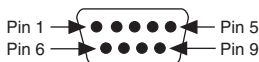

Table 4. DB-9 Male Pin Descriptions

Pin	232 DTE	232 DCE	422/485
1	DCD*	DCD	GND
2	RXD	TXD	CTS+ (HSI+)
3	TXD	RXD	RTS+ (HSO+)
4	DTR*	DSR	RXD+
5	GND	GND	RXD-
6	DSR*	DTR	CTS- (HSI-)
7	RTS	CTS	RTS- (HSO-)
8	CTS	RTS	TXD+
9	RI*	RI	TXD-

* These signals are “No Connect” on the PCI-232I and PXI-8422 ports and ports 9 to 16 on legacy 16-port boards.



Note DCE mode supported on USB-232/2 and USB-232/4 only.

DB-25 Male

Figure 2. DB-25 Connector Pin Locations

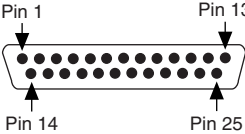

Table 5. DB-25 Pin Descriptions

Pin	232	422/485
2	TXD	RTS+ (HSO+)
3	RXD	CTS+ (HSI+)
4	RTS	RTS- (HSO-)
5	CTS	TXD+
6	DSR*	CTS- (HSI-)
7	GND	RXD-
8	DCD*	GND
20	DTR*	RXD+
22	RI*	TXD-

* These signals are “No Connect” on the PCI-232I and PXI-8422 ports.



Note Pins not listed in this table are “No Connect.”

10-Position Modular Jack (10P10C)

Figure 3. 10-Position Modular Jack Pin Locations

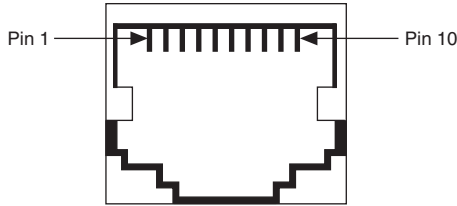

Table 6. 10-Position Modular Jack Pin Descriptions

Pin	232	422/485
1	No Connect	No Connect
2	RI*	TXD-
3	CTS	TXD+
4	RTS	RTS- (HSO-)
5	DSR*	CTS- (HSI-)
6	GND	RXD-
7	DTR*	RXD+
8	TXD	RTS+ (HSO+)
9	RXD	CTS+ (HSI+)
10	DCD*	GND

* These signals are “No Connect” on the PCI-232I and PXI-8422 ports.

68-Pin Connector

The following figure and table give the 68-pin connector pin locations and descriptions. The SCSI 68-pin connector and VHDCI 68-pin connector have the same pinout.

Figure 4. 68-Pin SCSI Connector Pin Locations

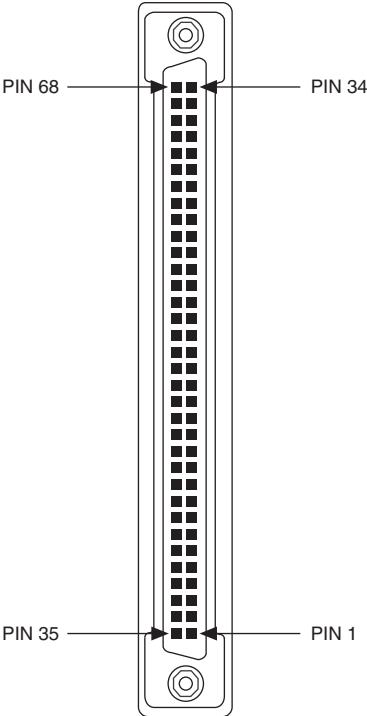

Table 7. 68-Pin Connector Pin Descriptions

68-Pin Connector Port								485 Signal	485 D-Sub 9 Connector	232 Signal	232 D-Sub 9 Connector
1	2	3	4	5	6	7	8				
66	57	49	40	32	23	15	6	RXD-	5	DCD	1
68	59	51	42	34	25	17	8	CTS+	2	RXD	2
65	56	48	39	31	22	14	5	RTS+	3	TXD	3
64	55	47	38	30	21	13	4	RXD+	4	DTR	4
60	60	43	43	26	26	9	9	GND	1	GND	5
63	54	46	37	29	20	12	3	CTS-	6	DSR	6
62	53	45	36	28	19	11	2	RTS-	7	RTS	7
61	52	44	35	27	18	10	1	TXD+	8	CTS	8
67	58	50	41	33	24	16	7	TXD-	9	RI	9

100-Pin Connector

The following figure and table give the pin locations and descriptions of the 100-pin connector.

Figure 5. 100-Pin Connector Pin Locations

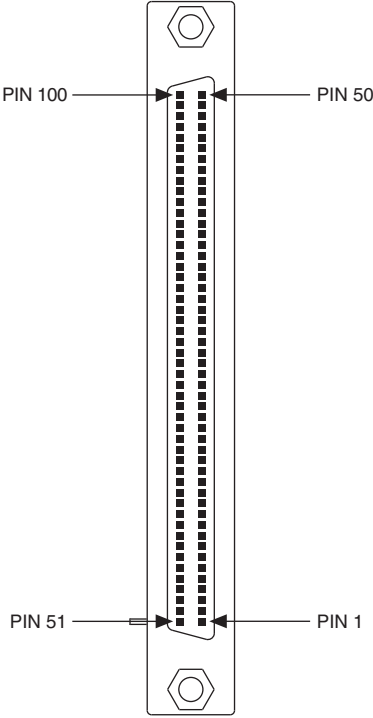

Table 8. 100-Pin Connector Pin Descriptions

100-Pin Connector Port																232 Signal	232 D-Sub 9 Connector
1	2	3	4	5	6	7	8	9	10	11	12	13	14	15	16		
2	46	6	42	10	38	14	34	—	—	—	—	—	—	—	—	DCD*	1
3	47	7	43	11	39	15	35	18	32	20	30	22	28	24	26	RXD	2
4	48	8	44	12	40	16	36	19	33	21	31	23	29	25	27	TXD	3
5	49	9	45	13	41	17	37	—	—	—	—	—	—	—	—	DTR*	4
1	1	1	1	50	50	50	50	51	51	51	51	100	100	100	100	GND	5
52	96	56	92	60	88	64	84	—	—	—	—	—	—	—	—	DSR*	6
53	97	57	93	61	89	65	85	68	82	70	80	72	78	74	76	RTS	7
54	98	58	94	62	90	66	86	69	83	71	81	73	79	75	77	CTS	8
55	99	59	95	63	91	67	87	—	—	—	—	—	—	—	—	RI*	9

* These signals are not supported on ports 9 to 16 of the PCI-232/16 and PXI-8420/16 serial boards.

Cables and Accessories

The following serial cables and accessories are available from National Instruments. Refer to ni.com for more information.

Table 9. Serial Cables and Accessories

Part Number	Description
Adapter Cables (DB-9 and DB-25 connectors have jacksockets unless otherwise specified.)	
182844-01	DB-9 RS485 terminating pass-through connector 120 Ω
182845-01	Serial cable, 10P10C modular plug to DB-9 male, 1 m
182845-02	Serial cable, 10P10C modular plug to DB-9 male, 2 m
182845-03	Serial cable, 10P10C modular plug to DB-9 male, 3 m
182846-01	Serial cable, 10P10C modular plug to DB-25 male, 1 m
184428-01	Serial cable, 10P10C modular plug to DB-9 male, 1 m, isolated
199022-02	Serial cable, 10P10C to DB-9 male, jackscrews, 2 m
197545-01	Serial cable, 68-pin VHDCI to eight DB-9 male, RS-232, 1 m
197546-01	Serial cable, 68-pin VHDCI to eight DB-9 male, RS-485, 1 m
Extension and Null-Modem Cables (All cables have jackscrews.)	
182238-01	Serial cable, RS232 null modem, DB-9 female to DB-9 female, 1 m
182238-02	Serial cable, RS232 null modem, DB-9 female to DB-9 female, 2 m
182238-04	Serial cable, RS232 null modem, DB-9 female to DB-9 female, 4 m
183045-01	Serial cable, RS232 straight through, DB-9 female to DB-9 female, 1 m
183045-02	Serial cable, RS232 straight through, DB-9 female to DB-9 female, 2 m
183045-04	Serial cable, RS232 straight through, DB-9 female to DB-9 female, 4 m
183283-01	Serial cable, RS485/RS422 null modem, DB-9 female to DB-9 female, 1 m
183283-02	Serial cable, RS485/RS422 null modem, DB-9 female to DB-9 female, 2 m
183283-04	Serial cable, RS485/RS422 null modem, DB-9 female to DB-9 female, 4 m

RS-232, RS-422, and RS-485

RS-232, RS-422, and RS-485 Features

Table 10. RS-232, RS-422, and RS-485 Features

Feature	RS-232	RS-422	RS-485
Type of transmission lines	Single ended	Differential	Differential
Maximum number of drivers	1	1	32
Maximum number of receivers	1	10	32
Maximum cable length	50 ft	4,000 ft	4,000 ft
Maximum CMV	± 25 V	± 7 V	+12 to -7 V
Driver output*	5 to 25 V	2 to 6 V	1.5 to 6 V
Driver load	<3 k Ω	100 Ω	60 Ω

* Actual driver output varies depending on cable length and load.

RS-232 Loopback

Figure 6. RS-232 Loopback

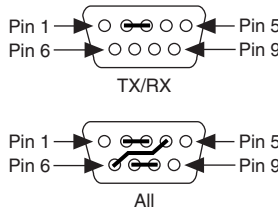

RS-232 Signals

Figure 7. RS-232 Signals

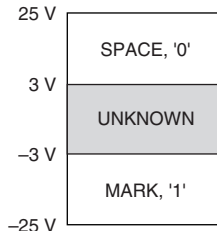

RS-485/422 Loopback

Figure 8. RS-485/422 Loopback

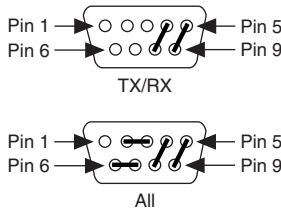

RS-485/422 Signals

Figure 9. RS-485/422 Signals

If '-' < '+' then MARK, '1'
If '-' > '+' then SPACE, '0'
RS-422 Voltage: $\pm 7\text{ V}$
RS-485 Voltage: $-7\text{ V to }+12\text{ V}$

RS-485 Topologies

Figure 10. 2-Wire Multidrop Network Using Terminating Resistors

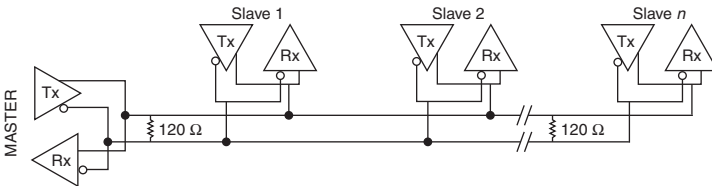
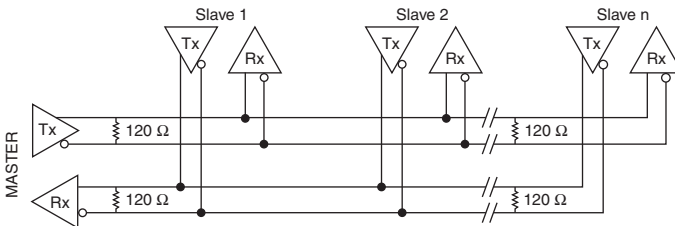

Figure 11. 4-Wire Full-Duplex Multidrop Network Using Terminating Resistors



The driver directly supports 4-wire full-duplex operation on peer-to-peer RS-485 networks. Multidrop RS-485 networks require additional software development.

RS-485 terminators are available at ni.com/serial.

RS-485 Transceiver Control

Enable	4-Wire	2-Wire		
		DTR/Echo	DTR/No Echo	Auto
TX	ON	DTR	DTR	TX
RX	ON	ON	$\overline{\text{DTR}}$	$\overline{\text{TX}}$

The available modes might vary with the controller or interface used. For further information refer to ni.com/kb and search for KnowledgeBase **67KEP64G**.

UART Data Frame Example

0xD9—8 Data Bits, Odd Parity, 1 Stop Bit

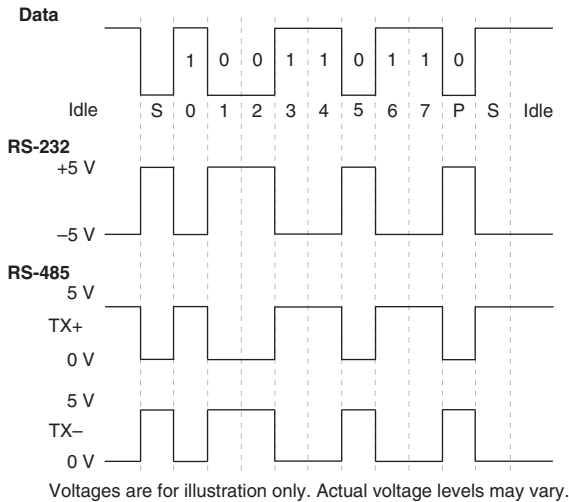

Hardware Specifications

Legacy PCI Serial Hardware

This section describes the characteristics of the legacy PCI serial hardware and the recommended operating conditions.

PCI-232/2 (RS-232) and PCI-485/2 (RS-485/422)

Dimensions	10.67 × 14.22 cm (4.2 × 5.6 in.)
I/O connector	DB-9 male connector
Power requirement (from PCI channel)	
PCI-485/2	
+5 VDC.....	350 mA typical 750 mA maximum
PCI-232/2	
+5 VDC.....	50 mA typical 100 mA maximum
±12 VDC.....	20 mA typical 200 mA maximum

Maximum baud rate

PCI-232/2.....	115.2 kbps
PCI-485/2.....	430.8 kbps

Boards support standard baud rates below the maximum.

PCI-232/4 (RS-232) and PCI-485/4 (RS-485/422)

Dimensions	10.67 × 14.22 cm (4.2 × 5.6 in.)
I/O connector ¹	10-position modular jack (10P10C)
Power requirement (from PCI channel)	
PCI-485/4	
+5 VDC.....	700 mA typical 1.3 A maximum
PCI-232/4	
+5 VDC.....	70 mA typical 150 mA maximum
±12 VDC.....	40 mA typical 400 mA maximum

¹ The four-port legacy PCI serial boards require a cable to convert the 10-position modular jack (10P10C) to either DB-9 or DB-25 male connectors.

Maximum baud rate

PCI-232/4	115.2 kbps
PCI-485/4	430.8 kbps

Boards support standard baud rates below the maximum.

PCI-232/8 (RS-232) and PCI-485/8 (RS-485/422)

Dimensions	10.67 × 14.48 cm (4.2 × 5.7 in.)
------------------	-------------------------------------

I/O connector ¹	68-pin, SCSI type connector
----------------------------------	-----------------------------

Power requirement (from PCI channel)

PCI-485/8	
+5 VDC	1.1 A typical 2.0 A maximum
PCI-232/8	
+5 VDC	100 mA typical 180 mA maximum
±12 VDC	80 mA typical 800 mA maximum

Maximum baud rate

PCI-232/8	115.2 kbps
PCI-485/8	430.8 kbps

Boards support standard baud rates below the maximum.

PCI-232/16 (RS-232)

Dimensions	10.67 × 17.52 cm (4.2 × 6.9 in.)
------------------	-------------------------------------

I/O connector ²	100-pin, SCSI type connector
----------------------------------	------------------------------

Power requirement (from PCI channel)

PCI-232/16	
+5 VDC	250 mA typical 500 mA maximum

Maximum baud rate	115.2 kbps
-------------------------	------------

Board supports standard baud rates below the maximum.

¹ The eight-port legacy PCI serial boards require a cable, included in your kit, to convert the 68-pin connector to eight DB-9 male connectors.

² The 16-port legacy PCI serial boards require a breakout box, included in your kit, to separate the 100-pin SCSI connector to 16 DB-9 male connectors.

PCI-232i/2 (RS-232) and PCI-485i/2 (RS-485/422)

Dimensions	10.67 × 17.52 cm (4.2 × 6.9 in.)
I/O connector	DB-9 male connector
Operating rated voltage (continuous)	
RS-232	-25 V to +25 V
RS-485	-7 V to +12 V
Isolation voltages	
Port-to-port	
Continuous	60 VDC (CAT I)
Withstand	2000 V _{rms} , verified by a 5 s dielectric withstand test
Port-to-host	
Continuous	60 VDC (CAT I)
Withstand	2000 V _{rms} , verified by a 5 s dielectric withstand test
Power requirement (from PCI channel)	
PCI-485i/2	
+5 VDC	800 mA typical 1.3 A maximum
PCI-232i/2	
+5 VDC	400 mA typical 650 mA maximum

Maximum baud rate

PCI-232i/2	115.2 kbps
PCI-485i/2	430.8 kbps

Boards support standard baud rates below the maximum.

PCI-232i/4 (RS-232) and PCI-485i/4 (RS-485/422)

Dimensions	10.67 × 17.44 cm (4.2 × 6.9 in.)
I/O connector ¹	10-position modular jack (10P10C)
Operating rated voltage (continuous)	
RS-232	-25 V to +25 V
RS-485	-7 V to +12 V

¹ The four-port legacy PCI serial boards require a cable to convert the 10-position (10P10C) modular jack to either DB-9 or DB-25 male connectors.

Isolation voltages

Port-to-port

Continuous	60 VDC (CAT I)
Withstand	2000 V _{rms} , verified by a 5 s dielectric withstand test

Port-to-host

Continuous	60 VDC (CAT I)
Withstand	2000 V _{rms} , verified by a 5 s dielectric withstand test

Power requirement (from PCI channel)

PCI-485i/4

+5 VDC	1.0 A typical
	1.5 A maximum

PCI-232i/4

+5 VDC	500 mA typical
	750 mA maximum

Maximum baud rate

PCI-232i/4	115.2 kbps
PCI-485i/4	430.8 kbps

Boards support standard baud rates below the maximum.

Environmental Characteristics (for All PCI Interfaces)

Operating Environment

Ambient temperature	0 to 55 °C (Tested in accordance with IEC-60068-2-1 and IEC-60068-2-2.)
Relative humidity	10 to 90%, noncondensing (Tested in accordance with IEC-60068-2-56.)
Altitude (maximum)	2,000 m
Pollution Degree	2

Indoor use only.

Storage Environment

Ambient temperature	-20 to 70 °C (Tested in accordance with IEC-60068-2-1 and IEC-60068-2-2.)
Relative humidity	5 to 95%, noncondensing (Tested in accordance with IEC-60068-2-56.)

Other Specifications

Maximum cable length

RS-485 ¹	30 m (limited by EMC/surge)
RS-232	2,500 pF equivalent (TIA-EIA-232-F 2.1.4)

Data line ESD protection (human body model)

RS-485	±15 kV
RS-232	±15 kV



Note This equipment is intended for indoor use only.

Safety

This product meets the requirements of the following standards of safety for electrical equipment for measurement, control, and laboratory use:

- IEC 61010-1, EN 61010-1
- UL 61010-1, CSA 61010-1



Note For UL and other safety certifications, refer to the product label or the [Online Product Certification](#) section.

Electromagnetic Compatibility

This product meets the requirements of the following EMC standards for electrical equipment for measurement, control, and laboratory use:

- EN 61326 (IEC 61326): Class A emissions; Basic immunity
- EN 55011 (CISPR 11): Group 1, Class A emissions
- AS/NZS CISPR 11: Group 1, Class A emissions
- FCC 47 CFR Part 15B: Class A emissions
- ICES-001: Class A emissions



Note For the standards applied to assess the EMC of this product, refer to the [Online Product Certification](#) section.



Note For EMC compliance, operate this device with shielded cabling.

CE Compliance

This product meets the essential requirements of applicable European Directives as follows:

- 2006/95/EC; Low-Voltage Directive (safety)
- 2004/108/EC; Electromagnetic Compatibility Directive (EMC)

¹ RS-485 is capable of 1.2 km (4,000 ft) without surge limitation.

Online Product Certification

Refer to the product Declaration of Conformity (DoC) for additional regulatory compliance information. To obtain product certifications and the DoC for this product, visit ni.com/certification, search by model number or product line, and click the appropriate link in the Certification column.

Environmental Management

NI is committed to designing and manufacturing products in an environmentally responsible manner. NI recognizes that eliminating certain hazardous substances from our products is beneficial to the environment and to NI customers.

For additional environmental information, refer to the *Minimize Our Environmental Impact* webpage at ni.com/environment. This page contains the environmental regulations and directives with which NI complies, as well as other environmental information not included in this document.

Waste Electrical and Electronic Equipment (WEEE)



EU Customers At the end of the product life cycle, all products *must* be sent to a WEEE recycling center. For more information about WEEE recycling centers, National Instruments WEEE initiatives, and compliance with WEEE Directive 2002/96/EC on Waste and Electronic Equipment, visit ni.com/environment/weee.

电子信息产品污染控制管理办法（中国 RoHS）



中国客户 National Instruments 符合中国电子信息产品中限制使用某些有害物质指令 (RoHS)。关于 National Instruments 中国 RoHS 合规性信息，请登录 ni.com/environment/rohs_china。(For information about China RoHS compliance, go to ni.com/environment/rohs_china.)

Legacy PXI Serial Hardware

This section describes the characteristics of the legacy PXI serial hardware and the recommended operating conditions.

PXI-8420/2 (RS-232) and PXI-8421/2 (RS-485/422)

Dimensions	100 × 160 mm (3.94 × 6.37 in.)
I/O connector	DB-9 male connector
Power requirement (from PXI channel)	
PXI-8420/2	
+5 VDC	100 mA typical 150 mA maximum
±12 VDC	20 mA typical 200 mA maximum

PXI-8421/2	
+5 VDC.....	350 mA typical 750 mA maximum

Maximum baud rate

PXI-8420/2	115.2 kbps
PXI-8421/2	430.8 kbps

Boards support standard baud rates below the maximum.

PXI-8420/4 (RS-232) and PXI-8421/4 (RS-485/422)

Dimensions	100 × 160 mm (3.94 × 6.37 in.)
------------------	-----------------------------------

I/O connector¹..... 10-position modular jack (10P10C)

Power requirement (from PXI channel)

PXI-8420/4	
+5 VDC.....	125 mA typical 200 mA maximum
±12 VDC.....	40 mA typical 400 mA maximum

PXI-8421/4	
+5 VDC.....	350 mA typical 750 mA maximum

Maximum baud rate

PXI-8420/4	115.2 kbps
PXI-8421/4	430.8 kbps

Boards support standard baud rates below the maximum.

PXI-8420/8 (RS-232) and PXI-8421/8 (RS-485/422)

Dimensions	100 × 160 mm (3.94 × 6.37 in.)
------------------	-----------------------------------

I/O connector²..... 68-pin, SCSI type connector

Power requirement (from PXI channel)

PXI-8420/8	
+5 VDC.....	150 mA typical 250 mA maximum
±12 VDC.....	80 mA typical 800 mA maximum

¹ The four-port legacy PXI serial boards require a cable to convert the 10-position modular jack (10P10C) to either DB-9 or DB-25 male connectors.

² The eight-port legacy PXI serial boards require a cable, included in your kit, to convert the 68-pin connector to eight DB-9 male connectors.

PXI-8421/8	
+5 VDC	1.1 A typical 2.0 A maximum

Maximum baud rate

PXI-8420/8	115.2 kbps
PXI-8421/8	430.8 kbps

Boards support standard baud rates below the maximum.

PXI-8420/16 (RS-232)

Dimensions	100 × 160 mm (3.94 × 6.37 in.)
------------------	-----------------------------------

I/O connector¹ 100-pin, SCSI type connector

Power requirement (from PXI channel)

PXI-8420/16	
+5 VDC	500 mA typical 750 mA maximum

Maximum baud rate 115.2 kbps

Board supports standard baud rates below the maximum.

PXI-8422/2 (RS-232) and PXI-8423/2 (RS-485/422)

Dimensions	100 × 160 mm (3.94 × 6.37 in.)
------------------	-----------------------------------

I/O connector DB-9 male connector

Operating rated voltage (continuous)

RS-232	-25 V to +25 V
RS-485	-7 V to +12 V

Isolation voltages

Port-to-port

Continuous	60 VDC (CAT I)
Withstand	2000 V _{rms} , verified by a 5 s dielectric withstand test

Port-to-host

Continuous	60 VDC (CAT I)
Withstand	2000 V _{rms} , verified by a 5 s dielectric withstand test

¹ The 16-port legacy PXI serial boards require a breakout box, included in your kit, to separate the 100-pin connector to 16 DB-9 male connectors.

Power requirement (from PXI channel)

PXI-8422/2

+5 VDC.....	400 mA typical
	650 mA maximum

PXI-8423/2

+5 VDC.....	800 mA typical, 1.3 A maximum
-------------	-------------------------------

Maximum baud rate

PXI-8422/2	115.2 kbps
------------------	------------

PXI-8423/2	430.8 kbps
------------------	------------

Boards support standard baud rates below the maximum.

PXI-8422/4 (RS-232) and PXI-8423/4 (RS-485/422)

Dimensions	100 × 160 mm
	(3.94 × 6.37 in.)

I/O connector ¹	10-position modular jack (10P10C)
----------------------------------	-----------------------------------

Operating rated voltage (continuous)

RS-232	-25 V to +25 V
--------------	----------------

RS-485	-7 V to +12 V
--------------	---------------

Isolation voltages

Port-to-port

Continuous.....	60 VDC (CAT I)
-----------------	----------------

Withstand	2000 V _{rms} ,
	verified by a 5 s dielectric withstand test

Port-to-host

Continuous.....	60 VDC (CAT I)
-----------------	----------------

Withstand	2000 V _{rms} ,
	verified by a 5 s dielectric withstand test

Power requirement (from PXI channel)

PXI-8422/4

+5 VDC.....	500 mA typical
	750 mA maximum

PXI-8423/4

+5 VDC.....	1.0 A typical
	1.5 A maximum

¹ The four-port legacy PXI serial boards require a cable to convert the 10-position modular jack (10P10C) to either DB-9 or DB-25 male connectors.

Maximum baud rate

PXI-8422/4.....	115.2 kbps
PXI-8423/4.....	430.8 kbps

Boards support standard baud rates below the maximum.

Environmental Characteristics (for All Legacy PXI Interfaces)

Operating Environment

Ambient temperature	0 to 55 °C (Tested in accordance with IEC-60068-2-1 and IEC-60068-2-2.)
Relative humidity.....	10 to 90%, noncondensing (Tested in accordance with IEC-60068-2-56.)
Altitude (maximum)	2,000 m
Pollution Degree	2

Indoor use only.

Storage Environment

Ambient temperature	-20 to 70 °C (Tested in accordance with IEC-60068-2-1 and IEC-60068-2-2.)
Relative humidity.....	5 to 95%, noncondensing (Tested in accordance with IEC-60068-2-56.)

Other Specifications

Maximum cable length

RS-485 ¹	30 m (limited by EMC/surge)
RS-232	2,500 pF equivalent (TIA-EIA-232-F 2.1.4)

Data line ESD protection (human body model)

RS-485	±15 kV
RS-232	±15 kV



Note This equipment is intended for indoor use only.

¹ RS-485 is capable of 1.2 km (4,000 ft) without surge limitation.

Safety

This product meets the requirements of the following standards of safety for electrical equipment for measurement, control, and laboratory use:

- IEC 61010-1, EN 61010-1
- UL 61010-1, CSA 61010-1



Note For UL and other safety certifications, refer to the product label or the [Online Product Certification](#) section.

Electromagnetic Compatibility

This product meets the requirements of the following EMC standards for electrical equipment for measurement, control, and laboratory use:

- EN 61326 (IEC 61326): Class A emissions; Basic immunity
- EN 55011 (CISPR 11): Group 1, Class A emissions
- AS/NZS CISPR 11: Group 1, Class A emissions
- FCC 47 CFR Part 15B: Class A emissions
- ICES-001: Class A emissions



Note For the standards applied to assess the EMC of this product, refer to the [Online Product Certification](#) section.



Note For EMC compliance, operate this device with shielded cabling.

CE Compliance

This product meets the essential requirements of applicable European Directives as follows:

- 2006/95/EC; Low-Voltage Directive (safety)
- 2004/108/EC; Electromagnetic Compatibility Directive (EMC)

Online Product Certification

Refer to the product Declaration of Conformity (DoC) for additional regulatory compliance information. To obtain product certifications and the DoC for this product, visit ni.com/certification, search by model number or product line, and click the appropriate link in the Certification column.

Environmental Management

NI is committed to designing and manufacturing products in an environmentally responsible manner. NI recognizes that eliminating certain hazardous substances from our products is beneficial to the environment and to NI customers.

For additional environmental information, refer to the *Minimize Our Environmental Impact* web page at ni.com/environment. This page contains the environmental regulations and directives with which NI complies, as well as other environmental information not included in this document.

Waste Electrical and Electronic Equipment (WEEE)



EU Customers At the end of the product life cycle, all products *must* be sent to a WEEE recycling center. For more information about WEEE recycling centers, National Instruments WEEE initiatives, and compliance with WEEE Directive 2002/96/EC on Waste and Electronic Equipment, visit ni.com/environment/weee.

电子信息产品污染控制管理办法（中国 RoHS）



中国客户 National Instruments 符合中国电子信息产品中限制使用某些有害物质指令 (RoHS)。关于 National Instruments 中国 RoHS 合规性信息，请登录 ni.com/environment/rohs_china。(For information about China RoHS compliance, go to ni.com/environment/rohs_china.)

Where to Go for Support

The NI website is your complete resource for technical support. At ni.com/support you have access to everything from troubleshooting and application development self-help resources to email and phone assistance from NI Application Engineers.

Visit ni.com/services for NI Factory Installation Services, repairs, extended warranty, and other services.

Visit ni.com/register to register your NI product. Product registration facilitates technical support and ensures that you receive important information updates from NI.

A Declaration of Conformity (DoC) is our claim of compliance with the Council of the European Communities using the manufacturer's declaration of conformity. This system affords the user protection for electromagnetic compatibility (EMC) and product safety. You can obtain the DoC for your product by visiting ni.com/certification. If your product supports calibration, you can obtain the calibration certificate for your product at ni.com/calibration.

NI corporate headquarters is located at 11500 North Mopac Expressway, Austin, Texas, 78759-3504. NI also has offices located around the world. For telephone support in the United States, create your service request at ni.com/support or dial 1 866 ASK MYNI (275 6964). For telephone support outside the United States, visit the Worldwide Offices section of ni.com/niglobal to access the branch office websites, which provide up-to-date contact information, support phone numbers, email addresses, and current events.

Refer to the *NI Trademarks and Logo Guidelines* at ni.com/trademarks for more information on NI trademarks. Other product and company names mentioned herein are trademarks or trade names of their respective companies. For patents covering NI products/technology, refer to the appropriate location: **Help»Patents** in your software, the `patents.txt` file on your media, or the *National Instruments Patents Notice* at ni.com/patents. You can find information about end-user license agreements (EULAs) and third-party legal notices in the `readme` file for your NI product. Refer to the *Export Compliance Information* at ni.com/legal/export-compliance for the NI global trade compliance policy and how to obtain relevant HTS codes, ECCNs, and other import/export data. NI MAKES NO EXPRESS OR IMPLIED WARRANTIES AS TO THE ACCURACY OF THE INFORMATION CONTAINED HEREIN AND SHALL NOT BE LIABLE FOR ANY ERRORS. U.S. Government Customers: The data contained in this manual was developed at private expense and is subject to the applicable limited rights and restricted data rights as set forth in FAR 52.227-14, DFAR 252.227-7014, and DFAR 252.227-7015.

© 2010–2017 National Instruments. All rights reserved.