

COMPREHENSIVE SERVICES

We offer competitive repair and calibration services, as well as easily accessible documentation and free downloadable resources.

SELL YOUR SURPLUS

We buy new, used, decommissioned, and surplus parts from every NI series. We work out the best solution to suit your individual needs.

 Sell For Cash  Get Credit  Receive a Trade-In Deal

OBSOLETE NI HARDWARE IN STOCK & READY TO SHIP

We stock **New**, **New Surplus**, **Refurbished**, and **Reconditioned** NI Hardware.



Bridging the gap between the manufacturer and your legacy test system.

 1-800-915-6216

 www.apexwaves.com

 sales@apexwaves.com

All trademarks, brands, and brand names are the property of their respective owners.

Request a Quote

 **CLICK HERE**

PCI-7833R

Getting Started with R Series Multifunction RIO

このドキュメントの日本語版、『はじめにお読みください：安全対策と電磁両立性について』は、ni.com/manualsに掲載されています。

This document explains how to install and configure National Instruments PCI/PXI-781xR, PCI/PXI-783xR, PCIe/PXI-784xR, and PCIe/PXI-785xR, referred to collectively as NI 78xxR devices. This document also contains a tutorial section that demonstrates how to begin taking a measurement using a LabVIEW FPGA example VI.

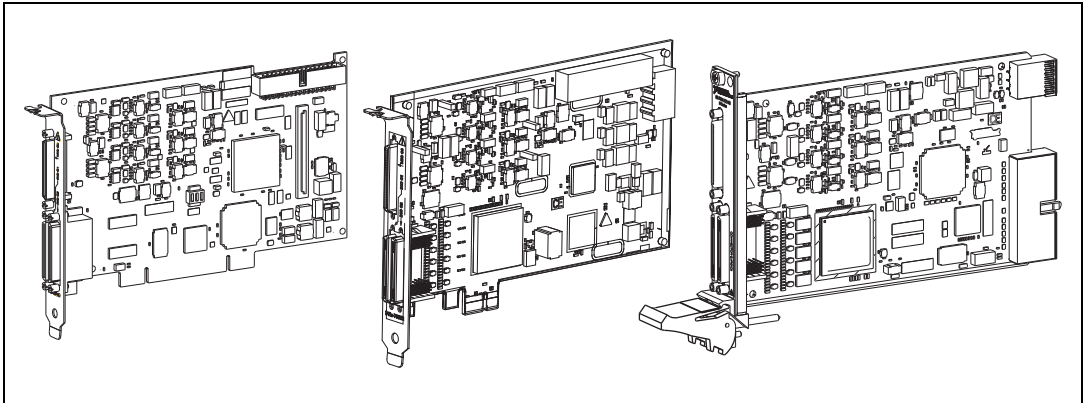

Figure 1. PCI, PCI Express, and PXI R Series Devices

NI 78xxR Required Components

The following items are necessary to set up and use the NI 78xxR:

- The following software packages:
 - LabVIEW
 - LabVIEW FPGA Module
 - NI-RIO device drivers
 - (Optional) LabVIEW Real-Time Module

Refer to [Step 1. Install Application Software and Driver](#), for information on R Series software support.

- Development computer or PXI/CompactPCI chassis and PXI/CompactPCI embedded controller running Windows Vista/XP/2000.
- At least one cable and accessory for connecting signals to the NI 78xxR. For a list of applicable cable and accessory options, refer to the [Connectivity Options](#) section.

Step 1. Install Application Software and Driver

Before installing the NI 78xxR, you need to install the application software and device driver. Visit ni.com/info and enter `rdsoftwareversion` to determine which minimum versions of software you need for the device you are using.

Refer to the *LabVIEW Release Notes* for installation instructions for LabVIEW and system requirements for the LabVIEW software. Refer to the *LabVIEW Upgrade Notes* for additional information about upgrading to the most recent version of LabVIEW for Windows.

Refer to the *LabVIEW FPGA Module Release and Upgrade Notes* for installation instructions and information on getting started with the LabVIEW FPGA Module.

Refer to the *LabVIEW Real-Time Module Release and Upgrade Notes* for system requirements, installation instructions, and additional information on using the LabVIEW Real-Time Module.

Refer to the *NI-RIO Readme* on NI-RIO installation media for system requirements and installation instructions for the NI-RIO driver.

The listed documents are available at ni.com/manuals. In LabVIEW 8.0 or later, you can also view the LabVIEW Manuals directory that contains these documents by selecting **Start»All Programs»National Instruments»LabVIEW»LabVIEW Manuals**.

Step 2. Install the Device, Accessories, and Cables

This section describes how to unpack and install the NI PCI/PCIe/PXI-78xxR devices.



Note You *must* install NI-RIO device driver software before installing the NI 78xxR.

Unpacking

The NI 78xxR is shipped in an antistatic package to prevent electrostatic discharge from damaging device components. To prevent such damage when handling the device, take the following precautions:

- Ground yourself using a grounding strap or by holding a grounded object, such as your computer chassis.
- Touch the antistatic package to a metal part of the computer chassis before removing the device from the package.



Caution *Never* touch the exposed pins of connectors.

Remove the device from the package and inspect the devices for loose components or any other sign of damage. Notify NI if the device appears damaged in any way. Do *not* install a damaged device into the computer.

Store the NI 78xxR in the antistatic envelope when not in use.

Installing the NI 78xxR

You can install the NI PCI/PCIe-78xxR in any available PCI/PCI Express expansion slot in the computer, and the NI PXI-78xxR in any available peripheral slot in the PXI or CompactPCI chassis. To achieve the best noise performance, leave as much room as possible between the NI PCI/PCIe-78xxR and other boards.



Note You must install the software before installing the hardware. For software installation information, refer to [Step 1. Install Application Software and Driver](#).

1. Power off and unplug the computer or PXI chassis.



Caution Refer to the *Read Me First: Safety and Electromagnetic Compatibility* document packaged with your PXI chassis or device before removing equipment covers or connecting or disconnecting any signal wires.

2. Remove the computer cover and/or the expansion slot cover on the computer, or the filler panel of an unused PXI slot on the PXI chassis.
3. Touch any metal part of the computer or chassis to discharge any static electricity.
4. For the NI PCI/PCIe-78xxR, insert the device into the applicable PCI/PCI Express system slot on your computer. Gently rock the device into place. Do *not* force the device into place. For the NI PXI-78xxR, insert the device into the PXI slot. Use the injector/ejector handle to fully inject the NI PXI-78xxR into place.

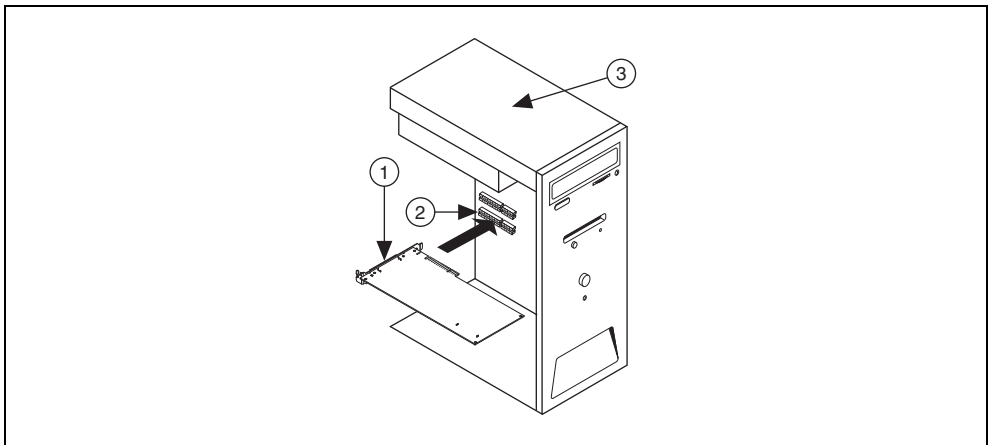

1 NI PCI/PCIe-78xxR Device 2 PCI/PCI Express System Slot 3 PC with PCI/PCI Express Slot

Figure 2. Installing an NI PCI/PCIe-78xxR Device

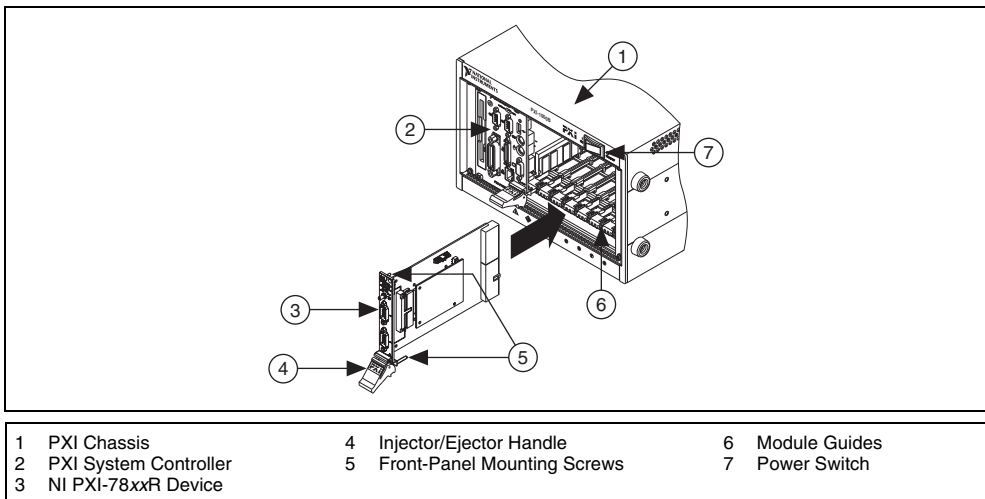

Figure 3. Installing an NI PXI-78xxR Device in a PXI Chassis

- For the NI PCI/PCIe-78xxR, secure the device mounting bracket to the computer back panel rail. For the NI PXI-78xxR, secure the device front panel to the chassis front panel mounting rail using the front-panel mounting screws.
- For the NI PCI/PCIe-78xxR, replace the computer cover, if applicable.
- Plug in and power on the computer or PXI chassis.

To confirm that your device is recognized, complete the following additional steps:

- Select **Start»All Programs»National Instruments»Measurement & Automation** to open Measurement & Automation Explorer (MAX).
- Expand **Devices and Interfaces**.
- Verify that the device appears under **Devices and Interfaces»RIO Devices**.



Step 3. Connect Signals

Figure 4 shows the I/O connector pin assignments and locations for NI 781xR digital-only R Series devices. Figure 5 shows the I/O connector pin assignments and locations for NI 783xR/784xR/785xR Multifunction R Series devices.

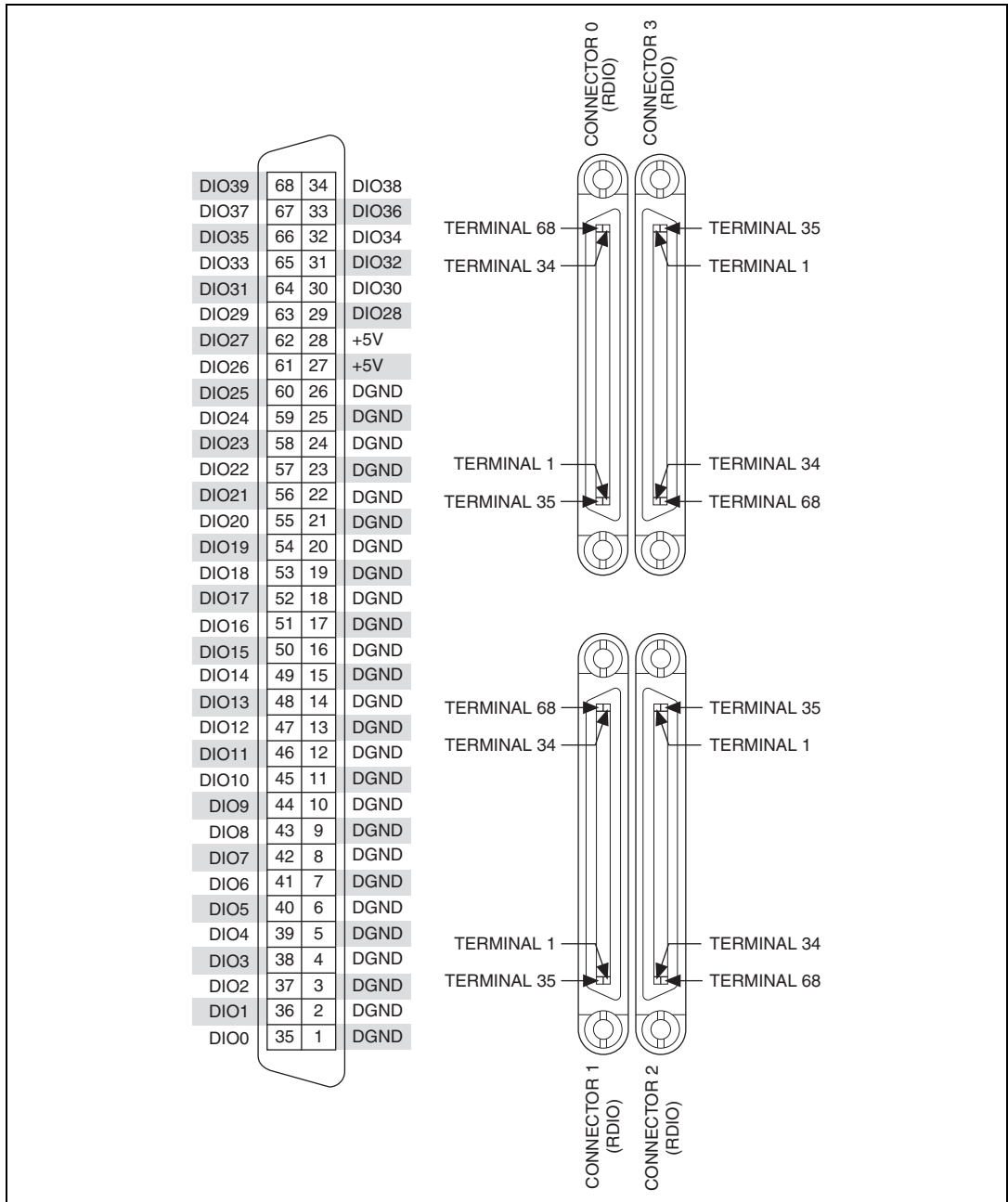
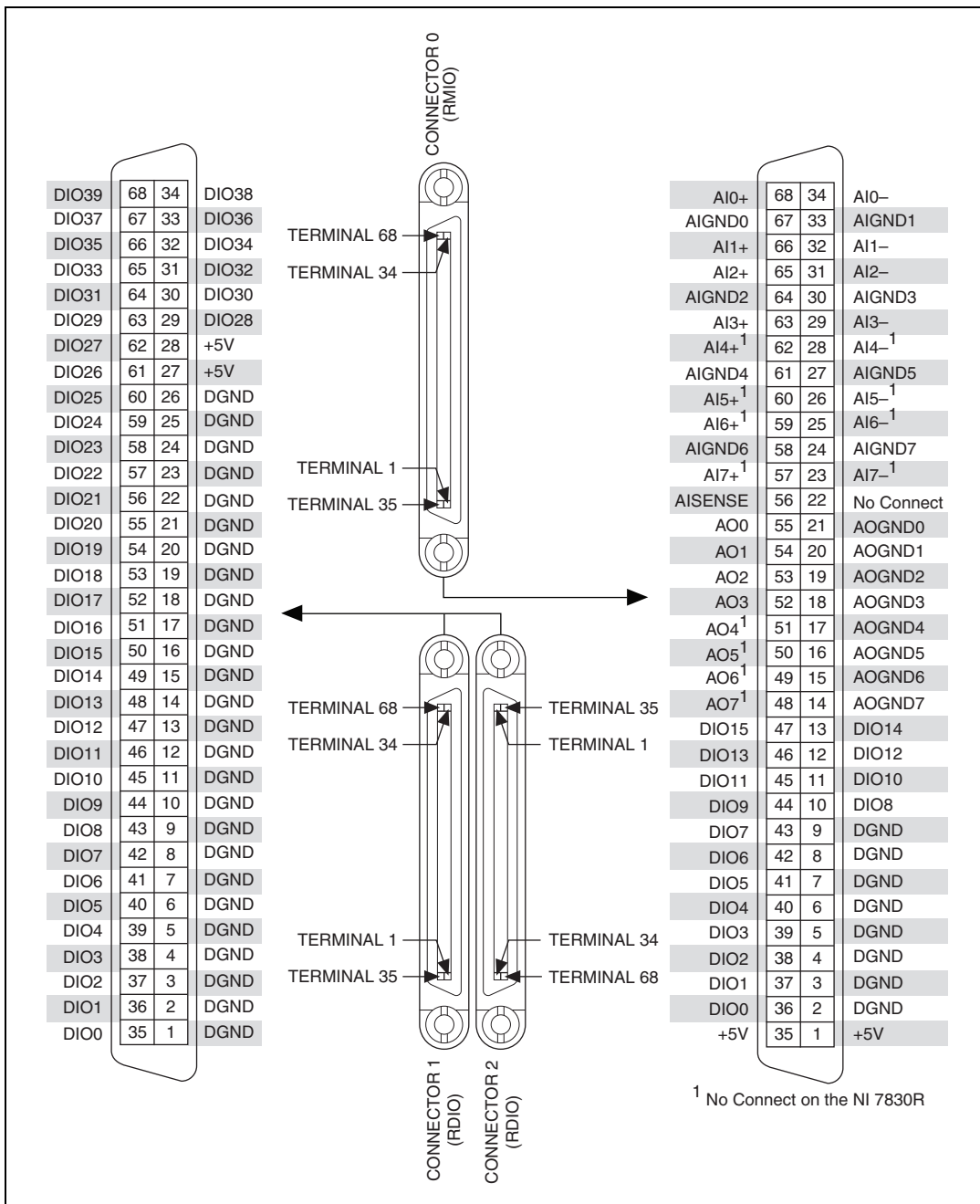

Figure 4. NI 781xR Connector Pin Assignments and Locations



¹ No Connect on the NI 7830R

Figure 5. NI 783xR/784xR/785xR Connector Pin Assignments and Locations



Caution Connections that exceed any of the maximum ratings of input or output signals on the NI 78xxR can damage the NI 78xxR device and the computer or chassis. NI is *not* liable for any damage resulting from such signal connections. For the maximum input and output ratings for each signal, refer to the *NI R Series Multifunction RIO Specifications*, available at ni.com/manuals.

The +5V terminals on the I/O connector supply +5 V referenced to D GND. Use these terminals to power external circuitry. All NI 78xxR devices are equipped with a fuse to protect the supply from overcurrent conditions. Refer to the *R Series Multifunction RIO User Manual*, available at ni.com/manuals, for information about the device-specific fuses.

Connectivity Options

Accessing the signals on the I/O connectors requires at least one cable and one signal accessory. Table 1 summarizes the National Instruments connectivity options available for use with the NI 78xxR device.

Table 1. R Series Connectivity Options

Cable	Connector		Accessory	Description
	NI 781xR	NI 783xR/ 784xR/785xR		
SHC68-68-RMIO (NI Recommended)	—	0	NI SCB-68	High-performance shielded cable wired specifically for signal connection from the RMIO connector [†] to the NI SCB-68 terminal block to provide higher signal integrity and noise immunity.
SHC68-68-RDIO (NI Recommended)	0, 1, 2, 3	1, 2*	NI SCB-68	High-performance shielded cable wired specifically for signal connection from the RDIO connector [†] to the NI SCB-68 terminal block to provide higher signal integrity and noise immunity.
SH68-C68-S	0, 1, 2, 3	1, 2*	NI SCB-68	Basic shielded cable for signal connection from the RMIO or RDIO connector to the NI SCB-68 terminal block for noise reduction.
* NI 7830R does not have Connector 2.				
[†] For a diagram of the twisted pairs in the SHC68-68-RMIO and SHC68-68-RDIO cables and the signals to which they correspond, go to ni.com/info and enter the info code <code>rdrmio</code> .				

For detailed information about connecting I/O signals, refer to the *NI R Series Multifunction RIO User Manual*, available at ni.com/manuals.

Step 4. Using Your NI 78xxR Device with a LabVIEW FPGA Example VI (NI 783xR/784xR/785xR Only)

The NI-RIO driver installation includes a variety of example projects to help get you started. This section demonstrates how to use an existing LabVIEW FPGA example project to take an analog input measurement with the NI 783xR/784xR/785xR device.



Note Examples available for your device are dependent on the device-specific minimum software requirements. For more information on software requirements for your device, refer to [Step 1. Install Application Software and Driver](#).

Each R Series example project includes:

- A LabVIEW FPGA VI that can be compiled and run embedded in FPGA hardware
- A Host VI that runs in LabVIEW for Windows and interacts with the LabVIEW FPGA VI

Each example is configured for a specific target and might not be pre-configured for your device. To use an example for a different target, you must copy the items contained within the VI to a new FPGA target.



Note To acquire real-world data in the analog input measurement taken in this example, you will also need to provide your own signal source, such as a battery or function generator.

To access the analog input example project and take a measurement, complete the following steps:

1. Launch LabVIEW.
2. In the **Getting Started** window, click **Find Examples** to display the NI Example Finder.
3. In the **NI Example Finder** window, select **Hardware Input and Output»R Series**. This directory holds several example projects designed to help you get started using your R Series device.
4. Select **Basic I/O** and then select **Analog Input - R Series.lvproj**.
5. The Analog Input example project opens in the **Project Explorer** window. This project is precompiled for the NI PCI-7831R. If you are not using an NI PCI-7831R, then you need to copy the example files into a new target directory and recompile the code. To compile **Analog Input - R Series.lvproj** for a new R Series target, complete the following steps:
 - a. In the **Project Explorer** window, right-click **My Computer** and select **New»Targets and Devices** to create a new target.
 - b. Select the **Existing target or device** radio button.
 - c. Expand the **FPGA Target** folder to display a list of the R Series devices you can add. From the list, select the device for which you want to create a new directory, and click **OK**. If your R Series device does not appear under this tree structure, refer to the [Step 2. Install the Device, Accessories, and Cables](#) section and confirm that the device was installed correctly.
 - d. In the **Project Explorer** window, expand the original FPGA target and locate the **Items to Move** folder. This folder holds all the target VIs and I/O resources necessary to run the example VI. Click on the folder and drag it to the new FPGA Target.



Note The new target must support all of the analog input items included in this folder.

- e. Right-click the **Analog Input (FPGA).vi** file within the **Items to Move** folder and select **Compile** to recompile the FPGA VI. Recompiling takes several minutes. When the bitstream generation is complete, close the **LabVIEW FPGA Compile Server**.
- f. Open **Analog Input (Host).vi** under **My Computer** and switch to the block diagram to update the host VI and its references to the FPGA VI.

- g. On the block diagram, right-click the **Open FPGA VI Reference** function and select **Configure Open FPGA VI Reference** from the shortcut menu.

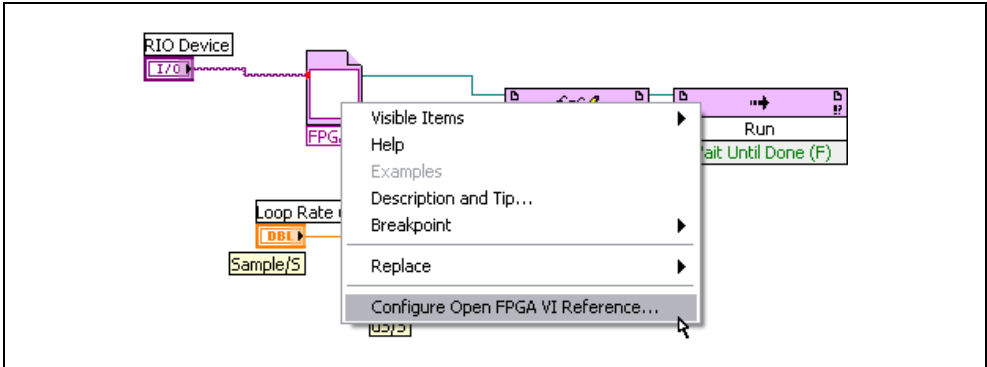

- h. In the **Configure Open FPGA VI Reference** dialog box, click the **Browse Project** button by the **Open»VI** field to open the Select VI dialog box.
- i. In the **Select VI** dialog box, select **Analog Input (FPGA).vi** in the new target and click **OK**.
- j. Click **OK** in the **Configure Open FPGA VI Reference** dialog box.



Note (LabVIEW version 8.5.1 and earlier) LabVIEW versions 8.5.1 and earlier do not use the Configure Open FPGA VI Reference dialog to update the FPGA target in the host VI. For LabVIEW version 8.5.1 and earlier, right-click the **Open FPGA VI Reference** function on the block diagram and choose **Select VI** from the shortcut menu. In the **Select VI** dialog box, select **Analog Input (FPGA).vi** in the new target and click **OK**.

- k. In the **Project Explorer** window, right-click the original FPGA target and select **Remove** to delete it from the project.
- l. Save the project to a new directory by selecting **File»Save As**.



6. Click the **Run** button in **Analog Input (Host).vi** to run the VI. The host VI displays the data being acquired by the R Series device. To view real-world data, wire a signal source or voltage source to AI0+ (RMIO pin 68) and AI0– (RMIO pin 34) of the terminal block.

Adding Analog Output to the FPGA Application

To expand the LabVIEW FPGA application to include analog output, complete the following steps:

1. On the block diagram of **Analog Input (FPGA).vi**, insert a new frame between the first and second frames of the Flat Sequence structure by right-clicking the divider between the first two frames and selecting **Insert Frame** from the shortcut menu, as shown in the following figure.

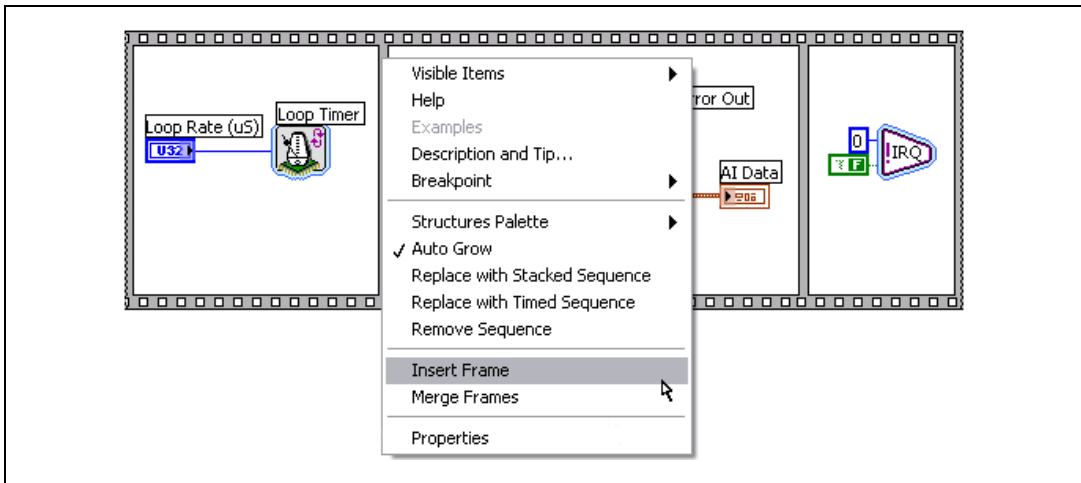

2. In the **Project Explorer** window, right-click the FPGA target and select **New»FPGA I/O**.
3. In the **New FPGA I/O** dialog box, expand **Connector0** and select **AO0**.



Note This example reflects the naming conventions and graphic interface of LabVIEW 8.6. Items such as FPGA I/O resources may appear differently if you are using earlier versions of LabVIEW.

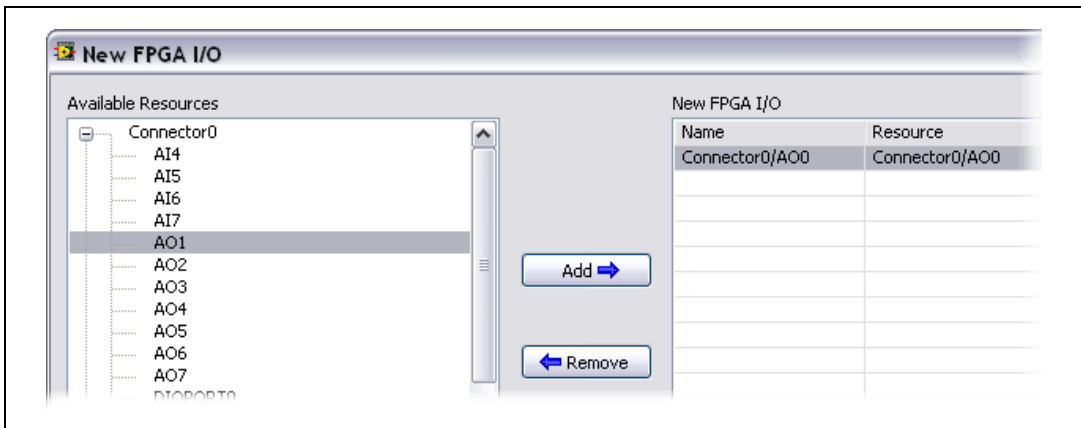

4. Click **Add**, then click **OK**.
5. Click **Connector0/AO0** in the **Project Explorer** window and drag it into the second frame of the Flat Sequence structure on the block diagram of the FPGA VI. The FPGA I/O Node is created automatically.

6. Right-click the input terminal of the new FPGA I/O Node and select **Create>Control** from the shortcut menu. Rename the control **AO Voltage (bits)**, as shown in the following block diagram.

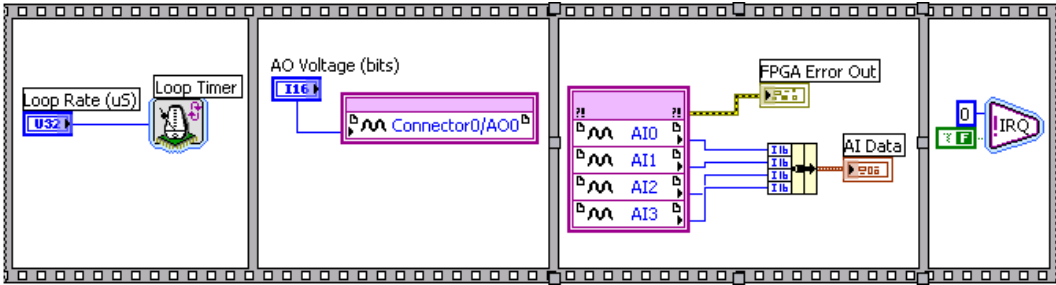

7. Save the VI, then right-click **Analog Input (FPGA).vi** in the **Project Explorer** window and select **Compile** from the shortcut menu to recompile the FPGA VI.
8. Modify the host VI to control the additional AO channel you created by completing the following steps:
 - a. Open the **Analog Input (Host).vi** block diagram.
 - b. Place a **Read/Write Control** from the **FPGA Interface** palette between the Invoke method and the Read/Write Control that already exists on the block diagram.
 - c. Wire the **FPGA VI Reference Out** terminal of the Invoke Method node to the **FPGA VI Reference In** terminal of the new Read/Write Control. Wire the **FPGA Reference Out** terminal of the new Read/Write Control to the **FPGA VI Reference In** terminal of the existing Read/Write Control.
 - d. Wire the **error out** output of the Invoke Method node to the **error in** input of the new Read/Write Control. Wire the **error out** output of the new Read/Write Control to the **error in** input of the existing Read/Write Control.
 - e. Click the section labeled **Unselected** and change it to **AO Voltage**.
 - f. Right-click the **AO Voltage (bits)** terminal and select **Create>Control**, as shown in the following block diagram.

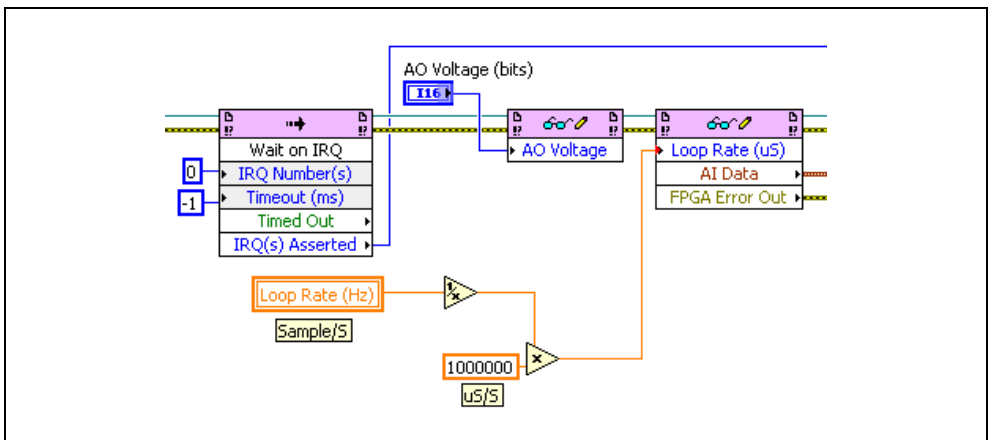

9. On the front panel, locate the numeric control labeled **AO Voltage (bits)**. Right-click the control, select **Replace** from the shortcut menu, and select **Knob** from the **Express»Numeric Controls** palette to change the control type to knob.
10. On the front panel, click and highlight the value in the lower limit of the knob to change the limit to -32000 . Click and highlight the value in the upper limit to change the limit to 32000 .

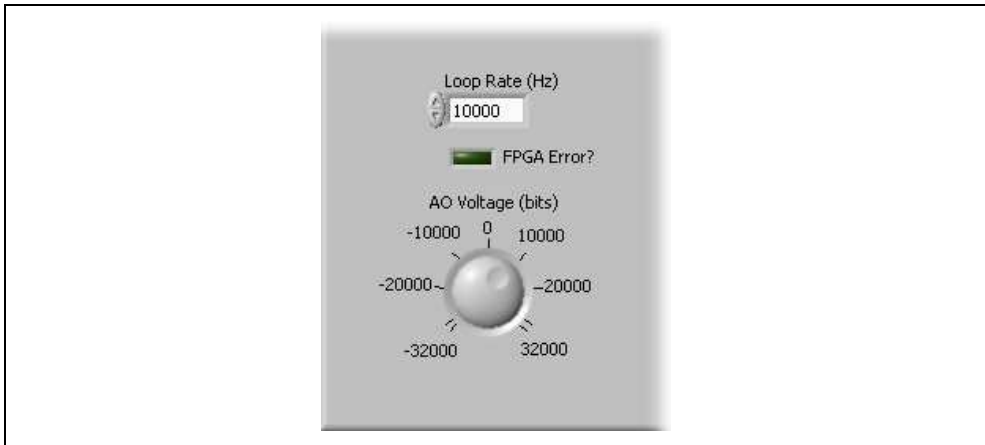

11. Save the VI.
12. Using the terminal block, connect analog output channel 0 to analog input channel 0 by wiring AI0+ (RMIO pin 68) to AO0 (RMIO pin 55) and AI0- (RMIO pin 34) to AOGND0 (RMIO pin 21), respectively.
13. Click the **Run** button in **Analog Input (Host).vi** and adjust the knob that controls analog output channel 0. Notice how the change in voltage affects the reading on analog input channel 0.

Where to Go From Here

The following resources contain information for writing applications and taking measurements with R Series Multifunction RIO devices.

Software Documentation

- LabVIEW FPGA documentation
 - *Getting Started with LabVIEW FPGA 8.x*—This KnowledgeBase, available at ni.com/kb, provides links to the top resources that can be used to assist in getting started with programming in LabVIEW FPGA.
 - *FPGA Module* book in the *LabVIEW Help*—Select **Help»Search the LabVIEW Help** in LabVIEW to view the *LabVIEW Help*. Browse the **FPGA Module** book in the **Contents** tab for information about how to use the FPGA Module to create VIs that run on the NI 78xxR device.
 - *LabVIEW FPGA Module Release and Upgrade Notes*—Contains information about installing the LabVIEW FPGA Module, describes new features, and provides upgrade information. To access this document, refer to ni.com/manuals. In LabVIEW 8.0 or later, you can also view the LabVIEW Manuals directory that contains this document by selecting **Start»All Programs»National Instruments»LabVIEW»LabVIEW Manuals**.

- *National Instruments Example Finder*—LabVIEW contains an extensive library of VIs and example programs for use with R Series devices. To access the NI Example Finder, open LabVIEW and select **Help»Find Examples**, then select **Hardware Input and Output»R Series**.
You can also access device-specific examples by selecting **Add device** from the **Hardware** pull-down menu in the NI Example Finder window.



Note If you are using the NI Example Finder for NI 784xR/785xR devices, you can select any NI 7831R/7833R device from the **Select devices to find examples for** list and reconfigure the example for your NI 784xR/785xR target.

Device-Specific Documentation

- *NI R Series Multifunction RIO User Manual*—Describes the electrical and mechanical aspects of the NI 78xxR R Series devices, and contains information about R Series device operation and programming. To access this document, refer to ni.com/manuals.
- *NI R Series Multifunction RIO Specifications*—Lists the specifications of the NI 78xxR R Series devices. To access this document, refer to ni.com/manuals.

Additional Resources

- *LabVIEW FPGA IPNet*—Offers resources for browsing, understanding, and downloading LabVIEW FPGA functions or IP (Intellectual Property). Use this resource to acquire IP that you need for your application, download examples to help learn programming techniques, and explore the depth of IP offered by the LabVIEW FPGA platform. To access the LabVIEW FPGA IPNet, visit ni.com/ipnet.

Where to Go for Support

The National Instruments Web site is your complete resource for technical support. At ni.com/support you have access to everything from troubleshooting and application development self-help resources to email and phone assistance from NI Application Engineers.

National Instruments corporate headquarters is located at 11500 North Mopac Expressway, Austin, Texas, 78759-3504. National Instruments also has offices located around the world to help address your support needs. For telephone support in the United States, create your service request at ni.com/support and follow the calling instructions or dial 512 795 8248. For telephone support outside the United States, contact your local branch office:

Australia 1800 300 800, Austria 43 662 457990-0, Belgium 32 (0) 2 757 0020,
 Brazil 55 11 3262 3599, Canada 800 433 3488, China 86 21 5050 9800,
 Czech Republic 420 224 235 774, Denmark 45 45 76 26 00, Finland 358 (0) 9 725 72511,
 France 01 57 66 24 24, Germany 49 89 7413130, India 91 80 41190000, Israel 972 3 6393737,
 Italy 39 02 41309277, Japan 0120-527196, Korea 82 02 3451 3400, Lebanon 961 (0) 1 33 28 28,
 Malaysia 1800 887710, Mexico 01 800 010 0793, Netherlands 31 (0) 348 433 466,
 New Zealand 0800 553 322, Norway 47 (0) 66 90 76 60, Poland 48 22 328 90 10,
 Portugal 351 210 311 210, Russia 7 495 783 6851, Singapore 1800 226 5886,
 Slovenia 386 3 425 42 00, South Africa 27 0 11 805 8197, Spain 34 91 640 0085,
 Sweden 46 (0) 8 587 895 00, Switzerland 41 56 2005151, Taiwan 886 02 2377 2222,
 Thailand 662 278 6777, Turkey 90 212 279 3031, United Kingdom 44 (0) 1635 523545

National Instruments, NI, ni.com, and LabVIEW are trademarks of National Instruments Corporation. Refer to the *Terms of Use* section on ni.com/legal for more information about National Instruments trademarks. Other product and company names mentioned herein are trademarks or trade names of their respective companies. For patents covering National Instruments products/technology, refer to the appropriate location: **Help»Patents** in your software, the `patents.txt` file on your media, or the *National Instruments Patent Notice* at ni.com/patents.