

VXI

Getting Started with Your VXI-1394 Interface for Windows NT/98

Worldwide Technical Support and Product Information

www.ni.com

National Instruments Corporate Headquarters

11500 North Mopac Expressway Austin, Texas 78759-3504 USA Tel: 512 794 0100

Worldwide Offices

Australia 03 9879 5166, Austria 0662 45 79 90 0, Belgium 02 757 00 20, Brazil 011 284 5011,
Canada (Calgary) 403 274 9391, Canada (Ontario) 905 785 0085, Canada (Québec) 514 694 8521,
China 0755 3904939, Denmark 45 76 26 00, Finland 09 725 725 11, France 01 48 14 24 24,
Germany 089 741 31 30, Greece 30 1 42 96 427, Hong Kong 2645 3186, India 91805275406,
Israel 03 6120092, Italy 02 413091, Japan 03 5472 2970, Korea 02 596 7456, Mexico (D.F.) 5 280 7625,
Mexico (Monterrey) 8 357 7695, Netherlands 0348 433466, Norway 32 27 73 00, Poland 48 22 528 94 06,
Portugal 351 1 726 9011, Singapore 2265886, Spain 91 640 0085, Sweden 08 587 895 00,
Switzerland 056 200 51 51, Taiwan 02 2377 1200, United Kingdom 01635 523545

For further support information, see the *Technical Support Resources* appendix. To comment on the documentation, send e-mail to techpubs@ni.com

© Copyright 1998, 1999 National Instruments Corporation. All rights reserved.

Important Information

Warranty

The National Instruments VXI-1394 board is warranted against defects in materials and workmanship for a period of one year from the date of shipment, as evidenced by receipts or other documentation. National Instruments will, at its option, repair or replace equipment that proves to be defective during the warranty period. This warranty includes parts and labor.

The media on which you receive National Instruments software are warranted not to fail to execute programming instructions, due to defects in materials and workmanship, for a period of 90 days from date of shipment, as evidenced by receipts or other documentation. National Instruments will, at its option, repair or replace software media that do not execute programming instructions if National Instruments receives notice of such defects during the warranty period. National Instruments does not warrant that the operation of the software shall be uninterrupted or error free.

A Return Material Authorization (RMA) number must be obtained from the factory and clearly marked on the outside of the package before any equipment will be accepted for warranty work. National Instruments will pay the shipping costs of returning to the owner parts which are covered by warranty.

National Instruments believes that the information in this document is accurate. The document has been carefully reviewed for technical accuracy. In the event that technical or typographical errors exist, National Instruments reserves the right to make changes to subsequent editions of this document without prior notice to holders of this edition. The reader should consult National Instruments if errors are suspected. In no event shall National Instruments be liable for any damages arising out of or related to this document or the information contained in it.

EXCEPT AS SPECIFIED HEREIN, NATIONAL INSTRUMENTS MAKES NO WARRANTIES, EXPRESS OR IMPLIED, AND SPECIFICALLY DISCLAIMS ANY WARRANTY OF MERCHANTABILITY OR FITNESS FOR A PARTICULAR PURPOSE. CUSTOMER'S RIGHT TO RECOVER DAMAGES CAUSED BY FAULT OR NEGLIGENCE ON THE PART OF NATIONAL INSTRUMENTS SHALL BE LIMITED TO THE AMOUNT THEREFORE PAID BY THE CUSTOMER. NATIONAL INSTRUMENTS WILL NOT BE LIABLE FOR DAMAGES RESULTING FROM LOSS OF DATA, PROFITS, USE OF PRODUCTS, OR INCIDENTAL OR CONSEQUENTIAL DAMAGES, EVEN IF ADVISED OF THE POSSIBILITY THEREOF. This limitation of the liability of National Instruments will apply regardless of the form of action, whether in contract or tort, including negligence. Any action against National Instruments must be brought within one year after the cause of action accrues. National Instruments shall not be liable for any delay in performance due to causes beyond its reasonable control. The warranty provided herein does not cover damages, defects, malfunctions, or service failures caused by owner's failure to follow the National Instruments installation, operation, or maintenance instructions; owner's modification of the product; owner's abuse, misuse, or negligent acts; and power failure or surges, fire, flood, accident, actions of third parties, or other events outside reasonable control.

Copyright

Under the copyright laws, this publication may not be reproduced or transmitted in any form, electronic or mechanical, including photocopying, recording, storing in an information retrieval system, or translating, in whole or in part, without the prior written consent of National Instruments Corporation.

Trademarks

CVI™, LabVIEW™, National Instruments™, ni.com™ NI-488.2™, NI-DAQ™, NI-VISA™, and NI-VXI™ are trademarks of National Instruments Corporation.

FireWire is a trademark of Apple Computer, Inc. Product and company names mentioned herein are trademarks or trade names of their respective companies.

WARNING REGARDING USE OF NATIONAL INSTRUMENTS PRODUCTS

(1) NATIONAL INSTRUMENTS PRODUCTS ARE NOT DESIGNED WITH COMPONENTS AND TESTING FOR A LEVEL OF RELIABILITY SUITABLE FOR USE IN OR IN CONNECTION WITH SURGICAL IMPLANTS OR AS CRITICAL COMPONENTS IN ANY LIFE SUPPORT SYSTEMS WHOSE FAILURE TO PERFORM CAN REASONABLY BE EXPECTED TO CAUSE SIGNIFICANT INJURY TO A HUMAN.

(2) IN ANY APPLICATION, INCLUDING THE ABOVE, RELIABILITY OF OPERATION OF THE SOFTWARE PRODUCTS CAN BE IMPAIRED BY ADVERSE FACTORS, INCLUDING BUT NOT LIMITED TO FLUCTUATIONS IN ELECTRICAL POWER SUPPLY, COMPUTER HARDWARE MALFUNCTIONS, COMPUTER OPERATING SYSTEM SOFTWARE FITNESS, FITNESS OF COMPILERS AND DEVELOPMENT SOFTWARE USED TO DEVELOP AN APPLICATION, INSTALLATION ERRORS, SOFTWARE AND HARDWARE COMPATIBILITY PROBLEMS, MALFUNCTIONS OR FAILURES OF ELECTRONIC MONITORING OR CONTROL DEVICES, TRANSIENT FAILURES OF ELECTRONIC SYSTEMS (HARDWARE AND/OR SOFTWARE), UNANTICIPATED USES OR MISUSES, OR ERRORS ON THE PART OF THE USER OR APPLICATIONS DESIGNER (ADVERSE FACTORS SUCH AS THESE ARE HEREAFTER COLLECTIVELY TERMED "SYSTEM FAILURES"). ANY APPLICATION WHERE A SYSTEM FAILURE WOULD CREATE A RISK OF HARM TO PROPERTY OR PERSONS (INCLUDING THE RISK OF BODILY INJURY AND DEATH) SHOULD NOT BE RELIANT SOLELY UPON ONE FORM OF ELECTRONIC SYSTEM DUE TO THE RISK OF SYSTEM FAILURE. TO AVOID DAMAGE, INJURY, OR DEATH, THE USER OR APPLICATION DESIGNER MUST TAKE REASONABLY PRUDENT STEPS TO PROTECT AGAINST SYSTEM FAILURES, INCLUDING BUT NOT LIMITED TO BACK-UP OR SHUT DOWN MECHANISMS. BECAUSE EACH END-USER SYSTEM IS CUSTOMIZED AND DIFFERS FROM NATIONAL INSTRUMENTS' TESTING PLATFORMS AND BECAUSE A USER OR APPLICATION DESIGNER MAY USE NATIONAL INSTRUMENTS PRODUCTS IN COMBINATION WITH OTHER PRODUCTS IN A MANNER NOT EVALUATED OR CONTEMPLATED BY NATIONAL INSTRUMENTS, THE USER OR APPLICATION DESIGNER IS ULTIMATELY RESPONSIBLE FOR VERIFYING AND VALIDATING THE SUITABILITY OF NATIONAL INSTRUMENTS PRODUCTS WHENEVER NATIONAL INSTRUMENTS PRODUCTS ARE INCORPORATED IN A SYSTEM OR APPLICATION, INCLUDING, WITHOUT LIMITATION, THE APPROPRIATE DESIGN, PROCESS AND SAFETY LEVEL OF SUCH SYSTEM OR APPLICATION.

Compliance

FCC/Canada Radio Frequency Interference Compliance*

Determining FCC Class

The Federal Communications Commission (FCC) has rules to protect wireless communications from interference. The FCC places digital electronics into two classes. These classes are known as Class A (for use in industrial-commercial locations only) or Class B (for use in residential or commercial locations). Depending on where it is operated, this product could be subject to restrictions in the FCC rules. (In Canada, the Department of Communications (DOC), of Industry Canada, regulates wireless interference in much the same way.)

Digital electronics emit weak signals during normal operation that can affect radio, television, or other wireless products. By examining the product you purchased, you can determine the FCC Class and therefore which of the two FCC/DOC Warnings apply in the following sections. (Some products may not be labelled at all for FCC, if so the reader should then assume these are Class A devices.)

FCC Class A products only display a simple warning statement of one paragraph in length regarding interference and undesired operation. Most of our products are FCC Class A. The FCC rules have restrictions regarding the locations where FCC Class A products can be operated.

FCC Class B products display either a FCC ID code, starting with the letters **EXN**, or the FCC Class B compliance mark that appears as shown here on the right.

The curious reader can consult the FCC web site <http://www.fcc.gov> for more information.

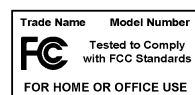

FCC/DOC Warnings

This equipment generates and uses radio frequency energy and, if not installed and used in strict accordance with the instructions in this manual and the CE Mark Declaration of Conformity**, may cause interference to radio and television reception. Classification requirements are the same for the Federal Communications Commission (FCC) and the Canadian Department of Communications (DOC).

Changes or modifications not expressly approved by National Instruments could void the user's authority to operate the equipment under the FCC Rules.

Class A

Federal Communications Commission

This equipment has been tested and found to comply with the limits for a Class A digital device, pursuant to part 15 of the FCC Rules. These limits are designed to provide reasonable protection against harmful interference when the equipment is operated in a commercial environment. This equipment generates, uses, and can radiate radio frequency energy and, if not installed and used in accordance with the instruction manual, may cause harmful interference to radio communications. Operation of this equipment in a residential area is likely to cause harmful interference in which case the user will be required to correct the interference at his own expense.

Canadian Department of Communications

This Class A digital apparatus meets all requirements of the Canadian Interference-Causing Equipment Regulations.

Cet appareil numérique de la classe A respecte toutes les exigences du Règlement sur le matériel brouilleur du Canada.

Class B

Federal Communications Commission

This equipment has been tested and found to comply with the limits for a Class B digital device, pursuant to part 15 of the FCC Rules. These limits are designed to provide reasonable protection against harmful interference in a residential installation. This equipment generates, uses and can radiate radio frequency energy and, if not installed and used in accordance with the instructions, may cause harmful interference to radio communications. However, there is no guarantee that interference will not occur in a particular installation. If this equipment does cause harmful

interference to radio or television reception, which can be determined by turning the equipment off and on, the user is encouraged to try to correct the interference by one or more of the following measures:

- Reorient or relocate the receiving antenna.
- Increase the separation between the equipment and receiver.
- Connect the equipment into an outlet on a circuit different from that to which the receiver is connected.
- Consult the dealer or an experienced radio/TV technician for help.

Canadian Department of Communications

This Class B digital apparatus meets all requirements of the Canadian Interference-Causing Equipment Regulations.

Cet appareil numérique de la classe B respecte toutes les exigences du Règlement sur le matériel brouilleur du Canada.

European Union - Compliance to EEC Directives

Readers in the EU/EEC/EEA must refer to the Manufacturer's Declaration of Conformity (DoC) for information** pertaining to the CE Mark compliance scheme. The Manufacturer includes a DoC for most every hardware product except for those bought for OEMs, if also available from an original manufacturer that also markets in the EU, or where compliance is not required as for electrically benign apparatus or cables.

* Certain exemptions may apply in the USA, see FCC Rules §15.103 **Exempted devices**, and §15.105(c). Also available in sections of CFR 47.

** The CE Mark Declaration of Conformity will contain important supplementary information and instructions for the user or installer.

Contents

About This Manual

How To Use the Manual Set.....	xi
Conventions	xiii
Related Documentation.....	xiv

Chapter 1

Introduction

What You Need to Get Started	1-2
VXI-1394 Interface Kit Overview	1-2
Hardware Description	1-3
VXI-1394 Front Panel Features.....	1-4
Advanced Configuration Options.....	1-4
Software Description	1-4
National Instruments Application Software	1-6

Chapter 2

Installation and Configuration

Installing the Software	2-1
Install the NI-VXI, NI-VISA, and NI-488.2 Software.....	2-2
Complete the Software Installation	2-3
Configuring the Hardware (optional)	2-3
Installing the Hardware.....	2-4
Install Your PCI-1394 Interface Board	2-5
Install Your VXI-1394 Interface Board	2-6
Connect Cables.....	2-6
Power on the System	2-7
Software Configuration and Verification	2-7
VXI-1394/G Only — GPIB Configuration and Verification.....	2-7
Run T&M Explorer and Resman.....	2-8

Chapter 3

Developing Your Application

Configuration	3-1
Device Interaction.....	3-2
VISAIC and VIC	3-2
NI-488.2 Interactive Control	3-3
Advanced Communication.....	3-4

Programming with VXI and GPIB	3-4
Additional Compiler Information	3-6
Shared Memory	3-7
Additional Software Notes	3-7
Compatibility	3-7
System Configuration Functions	3-7
Low-Level VXIbus Access Functions	3-7
High-Level VXIbus Access Functions	3-8
Notes about VME Support	3-8
Debugging	3-9
NI Spy	3-9
VISAIC and VIC	3-9
NI-488.2 Troubleshooting Wizard	3-9

Appendix A Specifications

Appendix B Default Settings

Appendix C Advanced Hardware Configuration Settings

Appendix D Common Questions

Appendix E Technical Support Resources

Glossary

Index

Figures

Figure 2-1.	Typical VXI-1394 System.....	2-4
Figure 2-2.	Installing the PCI-1394 Host Adapter	2-5
Figure C-1.	VXI-1394 Default Configuration Settings	C-2
Figure C-2.	VXIBus Slot Configuration	C-3
Figure C-3.	EEPROM Operation	C-4
Figure C-4.	Receive External CLK SMB (Default)	C-6
Figure C-5.	Receive External CLK SMB with 50 W Termination	C-7
Figure C-6.	Receive External CLK SMB and Drive to the Backplane Unterminated	C-8
Figure C-7.	Receive External CLK SMB with 50 W Termination and Drive to the Backplane	C-9
Figure C-8.	Drive Inverted External CLK SMB.....	C-10
Figure C-9.	Drive Non-Inverted External CLK SMB	C-10
Figure C-10.	SMB Trigger Input Termination	C-11

Tables

Table 3-1.	NI-VXI/VISA Examples	3-5
Table B-1.	VXI-1394 Hardware Default Settings	B-1
Table B-2.	T&M Explorer Device Tab Default Settings	B-2
Table B-3.	T&M Explorer Shared Memory Tab Default Settings	B-2
Table B-4.	T&M Explorer VXI Bus Tab Default Settings	B-3

About This Manual

This manual contains instructions for installing and configuring either of two National Instruments VXI-1394 kits:

- VXI-1394 interface kit for Windows 98 and Windows NT
- VXI-1394/G interface kit for Windows NT

The VXI-1394 kit is a low-cost, *VXIplug&play*-compliant IEEE 1394 interface that gives external PCI-based computers the capabilities of embedded VXI controllers. The VXI-1394/G also adds the capabilities of a GPIB controller.

How To Use the Manual Set

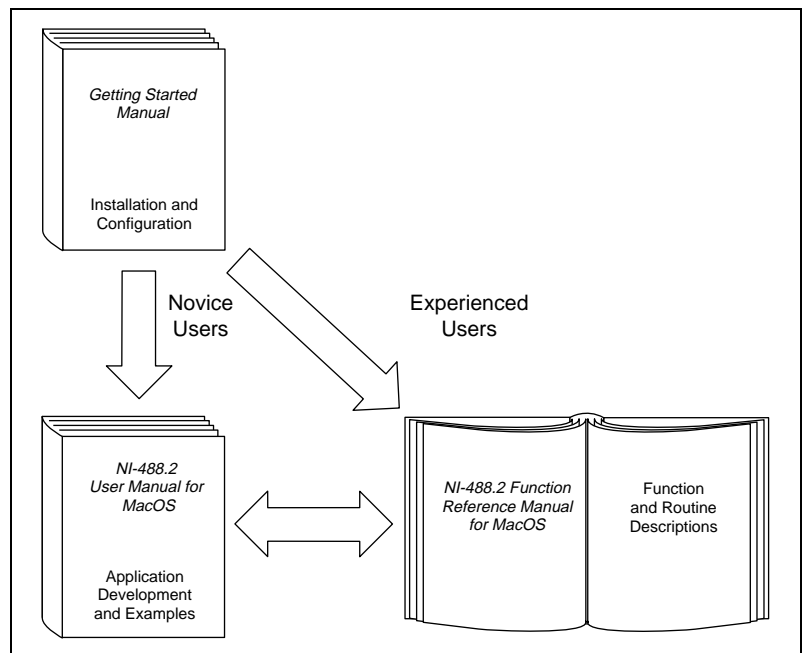

This getting started manual contains an overview of the VXI-1394 hardware, the NI-VXI/VISA software, and the NI-488.2 software, guides you through setting up your kit, and helps you get started with application development. You can also use this manual as a reference for the hardware and software default settings and to find the answers to commonly asked questions.

When you have successfully set up your system, you can begin to develop applications in NI-VXI, NI-VISA, and/or NI-488.2. Online manuals are included in your kit in the form of Adobe Acrobat version 3.0 portable document format (PDF) files. The *NI-VXI User Manual* presents the concepts of VXI and prepares you for detailed explanations of the NI-VXI functions. Study the descriptions of each function given in the online help utility to fully understand the purpose and syntax of each function.

The Acrobat manuals and their installed locations are as follows:

- The *NI-VISA User Manual* describes how to program using NI-VISA:
Start»Programs»VXIpn»NI-VISA User Manual
- The *NI-VISA Programmer Reference Manual* describes in detail the attributes, events, and operations you use in NI-VISA:
Start»Programs»VXIpn»NI-VISA Programmer Reference Manual
- The *NI-VXI User Manual* describes the features of NI-VXI:
Start»Programs»National Instruments VXI»NI-VXI User Manual
- The *NI-VXI Programmer Reference Manual* describes in detail the VXI/VME function calls in the C/C++ and BASIC languages:
Start»Programs»National Instruments VXI»NI-VXI Programmer Reference Manual
- Information about GPIB and NI-488.2 is available in the online help. Select **Start»Programs»National Instruments NI-488.2»Explore GPIB**. Then select **Help»Help Topics**.

Use the Acrobat Reader program, Version 3 or later, to open these files.



Note You can download Acrobat Reader from the Adobe Web site at www.adobe.com

Conventions

The following conventions appear in this manual:

»

The » symbol leads you through nested menu items and dialog box options to a final action. The sequence **File»Page Setup»Options** directs you to pull down the **File** menu, select the **Page Setup** item, and select **Options** from the last dialog box.

◆

The ◆ symbol indicates that the following text applies only to a specific product, a specific operating system, or a specific software version.



This icon denotes a note, which alerts you to important information.



This icon denotes a caution, which advises you of precautions to take to avoid injury, data loss, or a system crash.

bold

Bold text denotes items that you must select or click on in the software, such as menu items and dialog box options. Bold text also denotes parameter names.

italic

Italic text denotes variables, emphasis, a cross reference, or an introduction to a key concept. This font also denotes text that is a placeholder for a word or value that you must supply.

`monospace`

Text in this font denotes text or characters that you should enter from the keyboard, sections of code, programming examples, and syntax examples. This font is also used for the proper names of disk drives, paths, directories, programs, subprograms, subroutines, device names, functions, operations, variables, filenames and extensions, and code excerpts.

`monospace bold`

Bold text in this font denotes the messages and responses that the computer automatically prints to the screen. This font also emphasizes lines of code that are different from the other examples.

`monospace italic`

Italic text in this font denotes text that is a placeholder for a word or value that you must supply.

Platform

Text in this font denotes a specific platform and indicates that the text following it applies only to that platform.

Related Documentation

The following documents contain information that you may find helpful as you read this manual:

- ANSI/IEEE Standard 1014-1987, *IEEE Standard for a Versatile Backplane Bus: VMEbus*
- ANSI/IEEE Standard 1155-1998, *IEEE VMEbus Extensions for Instrumentation: VXIbus*
- ANSI/VITA 1-1994, *VME64*
- IEEE Standard 1394-1995, *IEEE Standard for a High Performance Serial Bus*
- *PCI Local Bus Specification*, Revision 2.1, PCI Special Interest Group
- *VXI-6, VXIbus Mainframe Extender Specification*, Rev. 2.0, VXIbus Consortium
- ANSI/IEEE Standard 488.1-1987, *IEEE Standard Digital Interface for Programmable Instrumentation*
- ANSI/IEEE Standard 488.2-1992, *IEEE Standard Codes, Protocols, and Common Commands*

Introduction

This chapter describes your VXI-1394 interface kit, lists what you need to get started, and includes a brief description of the hardware and software.

The VXI-1394 interface kit links a PCI-based computer to the VXIbus using the IEEE 1394, or FireWire, high-speed serial bus. This kit makes your computer perform as though it were plugged directly into the VXI backplane, giving your external computer the capability of an embedded computer. You can connect streaming devices such as digital cameras to either the VXI-1394 interface in your VXI mainframe or the PCI-1394 interface in your computer. IEEE 1394 features *hot plug-in* capability under Windows 98, which means you can add and configure 1394 devices without having to power down your system.

Your kit contains a National Instruments VXI-1394 interface module, which plugs into your VXI mainframe and links your computer to the VXIbus. The VXI-1394/G option adds a front panel connector for IEEE 488.2 devices so you can control a test system including both GPIB and VXI devices.

Your kit also contains an industry-standard OHCI host adapter, which links your PCI-based computer to the IEEE 1394 bus.



Note Windows 98 includes native support for the IEEE-1394 bus, but Windows NT 4 does not. National Instruments has developed a driver that works with the Adaptec AHA-8940 PCI-1394 host adapter and various OHCI boards. If you are using Windows NT 4, you must use this driver, which may not be compatible with other 1394 host adapters or built-in 1394 circuitry.

Your kit includes the NI-VXI/VISA bus interface software, which is fully *VXIplug&play* compliant. NI-VXI/VISA is the National Instruments implementation of the VISA I/O software standard on which all *VXIplug&play* software components are based.

If you ordered the VXI-1394/G, your kit also includes the industry-standard NI-488.2 software for GPIB communication.



Note The front panel GPIB connector on the VXI-1394/G is not supported under Windows 98.

What You Need to Get Started

- A computer running either Windows NT 4 or Windows 98
- An industry-standard OHCI host adapter
- VXIbus mainframe
- VXI-1394 interface module that plugs directly into a VXI mainframe
- 1394 cable
- National Instruments software CD
- This manual
- Windows 98 users** — Windows 98 installation CD-ROM

VXI-1394 Interface Kit Overview

The interface kits described in this manual link a 1394-equipped computer directly to the VXIbus using the IEEE 1394 bus. The VXI-1394 kit uses this high-speed (up to 400 Mbits/s) serial bus to link your computer running Windows NT/98 to a VXI chassis.



Note You can connect multiple 1394 devices together in a tree topology. However, increasing the complexity of the 1394 bus topology can lower overall system performance.



Caution You cannot connect multiple 1394 devices in a circular bus topology (one which provides more than one data path between any two nodes). Doing so will render your VXI-1394 inoperable and may crash your system.

All VXI-1394 kits include the NI-VXI/VISA software for Windows NT/98, a C-size VXI-1394 module, a 1394 cable, and an industry-standard OHCI host adapter.

A 1394-equipped computer connected to a VXI-1394 interface can function as a VXI Commander and Resource Manager. The VXI-1394 interface kit gives your computer the capability to perform as if it is plugged directly into the VXI backplane as an embedded CPU module.

The VXI-1394 transparently translates between the IEEE 1394 and VXI protocols.

A computer equipped with the VXI-1394/G can operate simultaneously as a GPIB Talker/Listener/Controller. The VXI-1394/G contains a TNT4882C single-chip IEEE 488.2 interface, which also implements the HS488 high-speed protocol, increasing the maximum GPIB data transfer rate up to 8 MB/s (depending on the system).

The software included with the kits is for x86/Pentium-based computers.

Hardware Description

The VXI-1394 module is a VXIbus device with optional VXIbus Slot 0 capability so that it can reside in any slot in a C-size or D-size chassis. If you enable this capability, the VXI-1394 can automatically determine whether it is located in VXI Slot 0.



Note D-size VXI mainframes have connections for a P3 connector. The VXI-1394, however, does not have this connector and, if configured as a Slot 0 controller, cannot provide the necessary control for VXI devices that need P3 support.



Caution An improper Slot 0 setting may damage the VXI-1394 module and/or the VXI chassis.

The VXI-1394 links the computer to the VXIbus and converts 1394 data transfers into VXIbus data transfers and vice versa. The VXI-1394 includes additional 1394 ports you can use to connect other 1394 devices.

The VXI-1394/G version includes a front-panel GPIB port you can use to integrate GPIB devices into your VXI-based instrumentation system without the need of a GPIB adapter in the host computer. The standard VXI-1394 and VXI-1394/G are otherwise functionally equivalent. The GPIB port on the VXI-1394/G cannot be used to control the VXIbus; it is intended for controlling only GPIB instruments through either NI-488.2 or NI-VISA. With the VXI-1394/G, you can control both GPIB and VXI instruments using a single 1394 cable from your host computer.

The PCI-1394 is an industry-standard 1394 host adapter on a PCI board, which gives your computer the capability to control 1394 devices. The PCI-1394 also supplies power to the IEEE 1394 bus, which is required by some devices.

VXI-1394 Front Panel Features

The VXI-1394 has the following front panel features.

- Three front panel LEDs
 - **SYSFAIL** LED indicates that the VMEbus SYSFAIL line is asserted.
 - **1394** LED indicates when the VXI-1394 is accessed from the IEEE 1394 bus.
 - **VXI** LED indicates when the VXI-1394 is accessed from the VXIbus.
- Three 1394 6-pin connectors
- GPIB connector (VXI-1394/G version only)
- Three SMB connectors
 - External clock
 - Trigger output
 - Trigger input
- System reset push-button

Advanced Configuration Options

The default hardware configuration of the VXI-1394 should be acceptable for most systems. Refer to Appendix C, [Advanced Hardware Configuration Settings](#), only if your system will make use of the front-panel CLK10 and trigger SMB connectors.

Software Description

NI-VXI is the name of the National Instruments VXI bus control library. You can create applications using NI-VXI to control both VXI and VME devices. NI-VXI gives you complete VXI/VME functionality, including an API for performing basic VXI/VME data transfers and handling VXI/VME interrupts as well as VXI-specific functionality, such as doing message-based communication and handling VXIbus triggers.

NI-VISA is the National Instruments implementation of the VISA specification. VISA is a uniform API for communicating with and controlling GPIB, VXI, and VME and Serial instruments. This API aids in the creation of more portable applications and instrument drivers.

The NI-VXI/VISA software includes an interactive configuration and troubleshooting program, libraries of software routines for test and measurement (T&M) programming, interactive control programs for both NI-VXI and NI-VISA, a logging utility you can use for debugging your applications, and a VXI Resource Manager. You can use this software to seamlessly program multiple-mainframe configurations and have software compatibility across a variety of controller platforms.

If your VXI-1394 model is the VXI-1394/G, it includes a GPIB port on its front panel, as well as the National Instruments NI-488.2 software kit, NI-488.2 is industry-standard software for controlling external GPIB instruments. Any GPIB application using either NI-488.2 or NI-VISA will run on the VXI-1394/G. Use the GPIB Configuration Utility to examine or modify the configuration of the NI-488.2 software.



Note You must run the GPIB Configuration Utility before you use the NI-488.2 software for Windows NT. For more information, refer to Chapter 2, *Installation and Configuration*.

Once your GPIB board is configured you can access additional GPIB utilities and help through T&M Explorer. Use T&M Explorer to view your entire T&M system and configure various components, whether they are Serial, GPIB, VXI, or VME devices. It is easy to add VME devices using T&M Explorer and view them on a screen display along with the rest of your system. This utility also adopts the functionality of the NI-DAQ Configuration utility so you can configure National Instruments VXI-DAQ cards.

T&M Explorer also features various options of how to run the VXI Resource Manager (Resman). You can still execute Resman independently to configure your instruments after a power cycle, but you can also perform resource manager operations directly from T&M Explorer or configure it to run Resman automatically at Windows startup.

The NI Spy utility tracks the calls your application makes to National Instruments T&M drivers, including NI-VXI, NI-VISA, and NI-488.2. NI Spy helps you debug your application by clearly highlighting the functions that return errors. You can let NI Spy keep a log of your program's calls to these drivers so that you can check them for errors at your convenience.

National Instruments Application Software

In addition to the NI-VXI, NI-VISA, and NI-488.2 software, you can use the National Instruments LabVIEW and LabWindows/CVI application programs and instrument drivers to ease your programming task. These standardized programs match the modular virtual instrument capability of VXI and can reduce your VXI/VME software development time. These programs are fully *VXIplug&play* compliant and feature extensive libraries of VXI instrument drivers written to take full advantage of direct VXI control. LabVIEW and LabWindows/CVI include all the tools needed for instrument control, data acquisition, analysis, and presentation.

LabVIEW is a complete programming environment that departs from the sequential nature of traditional programming languages and features a graphical programming environment.

LabWindows/CVI is an interactive C development environment for building test and measurement and instrument control systems. It includes interactive code-generation tools and a graphical editor for building custom user interfaces.

If you want to use either of these application programs, install them prior to installing the NI-VXI, NI-VISA, and NI-488.2 software. You also get hundreds of complete instrument drivers, which are modular, source-code programs that handle the communication with your instrument to speed your application development.

Installation and Configuration

This chapter explains how to set up your test system.

Installing the Software

Use the Setup program that came with your NI-VXI/VISA/488.2 software to install the entire software package or a software update, or to reinstall software in the event that your files were accidentally erased.



Note The front panel GPIB connector on the VXI-1394/G is not supported under Windows 98.

Some of the utilities rely on the LabWindows/CVI Run-Time Engine. This software is installed, if necessary, during the NI-VXI/VISA installation.

Depending on the type of installation you choose, you may need up to 20 MB of free space available on your hard drive to accommodate the NI-VXI, NI-VISA, and NI-488.2 software.

To be compliant with *VXIplug&play* specifications, a VXI controller must provide the VISA I/O driver library standardized by *VXIplug&play*. VISA ensures that your controller can run all *VXIplug&play*-compatible software now and in the future.

The NI-VISA software in this kit is compatible with the WINNT/GWINNT and WIN95/GWIN95 frameworks. With NI-VISA installed on your computer, you can run any *VXIplug&play* software that is compatible with these frameworks. This includes instrument drivers and executable soft front panel software that are included with *VXIplug&play*-compatible instruments from a variety of vendors.

Install the NI-VXI, NI-VISA, and NI-488.2 Software

This section describes how to install the 32-bit NI-VXI, NI-VISA, and NI-488.2 software. Please carefully read these directions along with any messages on the screen before making your selections.



Note Only VXI-1394/G users will be installing NI-488.2 on their systems.

You can quit the Setup program at any time by pressing the **Cancel** button.

Setup is an interactive, self-guiding program that installs the NI-VXI, NI-VISA, and NI-488.2 software and configures your system to use the software with the VXI-1394. Follow these steps to perform the installation:

1. For the CD, select **Start>Run** and enter the following text, where *x* is your CD drive (usually D):

`X:\setup.exe`

and press <Enter>.

For the floppy kit, insert the first disk and select **Start>Run...** and enter the following text, where *x* is your floppy drive (usually A or B):

`X:\setup.exe`

and press <Enter>.

2. Click on the **Next** button at the **Welcome** screen to start the installation and accept the license agreement.



Note If Setup detects a 16-bit (DOS or Windows 3.x) version of the NI-VXI software, it prompts you to remove it. Setup will quit so you can uninstall the old software. If you have a previous 32-bit (Windows NT/98) version of the NI-VXI software installed, Setup installs the new version over the previous version.



Caution If you want to keep the manufacturer/model name tables or the VME device configuration from a previous installation, be sure to back them up before starting Setup. They are located in the TBL subdirectory of your NI-VXI directory.

3. Select the type of installation from the **Installation Options** screen:
 - **Express** setup is the fastest and simplest installation option. This option installs all the software in default directories.
 - **Custom** setup gives you more control over which driver components you want installed on your system. This option is recommended for advanced users.

4. Select the version of the PCI-1394 you will be using. Select the default, 3-port OHCI board, unless you are using a 2-port Adaptec 1394 board that came with a previous VXI-1394 kit.
5. After selecting the board, the **Express** setup completes without further questions. Follow the prompts if you select the **Custom** setup option. The final prompt displays the choices you made concerning applications, support, and destination directories. Click on the **Next** button. Confirm that you are ready to install and click **Next** again to begin the installation.
6. Setup now copies the necessary files to your hard drive and creates program icons.

Complete the Software Installation

1. Please review the information in any `readme` files that Setup prompts you to read.
2. When the installation process completes, power off the system for the changes to take effect.

If you backed up the manufacturer and model name files, restore them to the `TBL` subdirectory of your NI-VXI directory before running T&M Explorer.

Configuring the Hardware (optional)

This section contains basic information about configuring your VXI-1394 hardware. Because the default settings for your VXI-1394 hardware are acceptable for most typical applications, this section is optional.

Refer to Appendix B, *Default Settings*, for a complete listing of the hardware and software default settings. Refer to Appendix C, *Advanced Hardware Configuration Settings*, if you want information about other possible settings.

Use the T&M Explorer utility in NI-VXI/VISA to change any of the configuration settings for the VXI-1394. For information on the software, including optional settings, use T&M Explorer and its online help. Use the Windows Start menu to open the program group for either NI-VXI or NI-VISA (VXIpn), launch T&M Explorer, and select **Help»Help Topics**.

Installing the Hardware

This section summarizes how to install your VXI-1394 hardware. Your kit contains a VXI-1394 interface module and a PCI-1394 adapter board.



Caution To guard against electrostatic discharge, touch the antistatic plastic packages to a metal part of your computer or chassis before removing the boards from their packages. Your computer or chassis should be plugged in but powered off.

Figure 2-1 illustrates a system that includes an IEEE 1394-equipped computer, a VXI-1394/G, IEEE 1394 devices, and a GPIB instrument. Each 1394 device should have only one connection to the 1394 system.

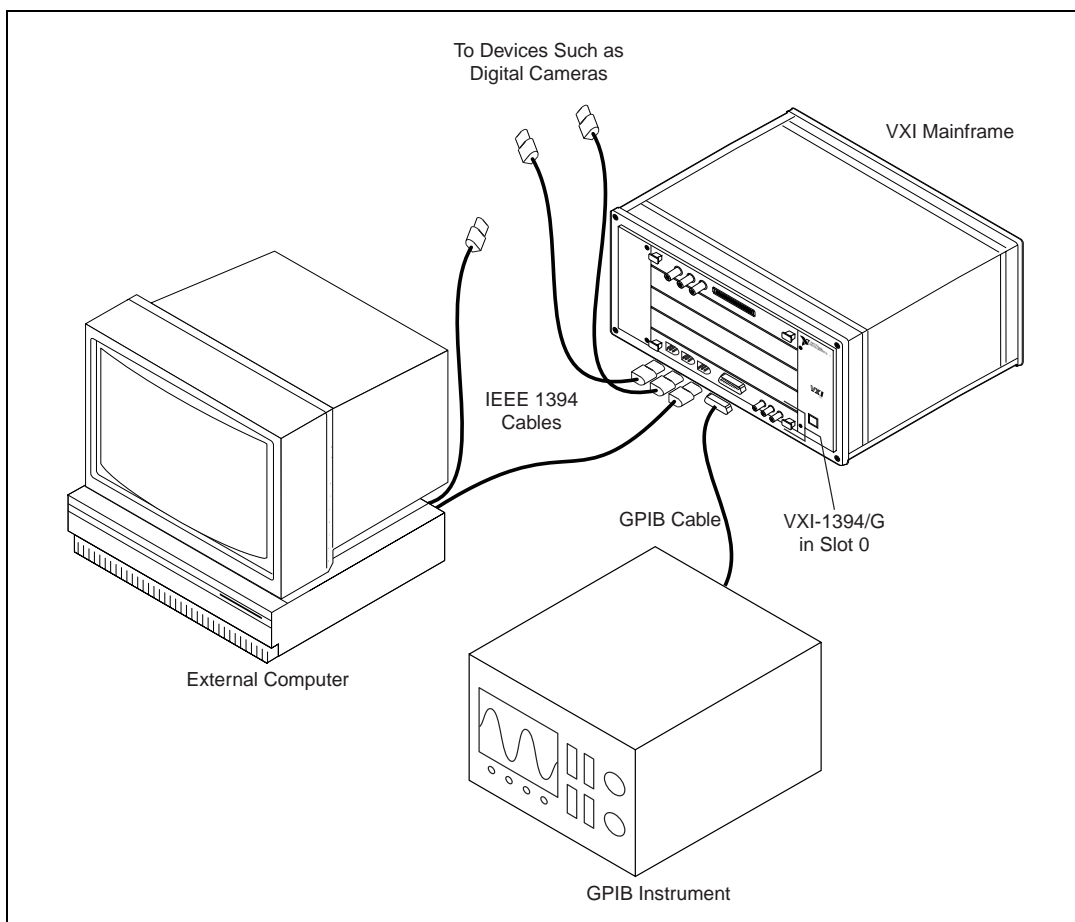

Figure 2-1. Typical VXI-1394 System

Install Your PCI-1394 Interface Board

The following are general installation instructions:

1. Shut down and power off the computer.
2. Remove the computer chassis cover to expose the expansion slots and external access covers.
3. Select an available PCI slot in your computer. The slot you select should support bus mastering. Refer to your computer documentation to determine if the slot you select supports bus mastering.
4. Remove the corresponding expansion slot cover from the chassis.
5. Align the bus connector on the bottom of the host adapter with the PCI bus slot.

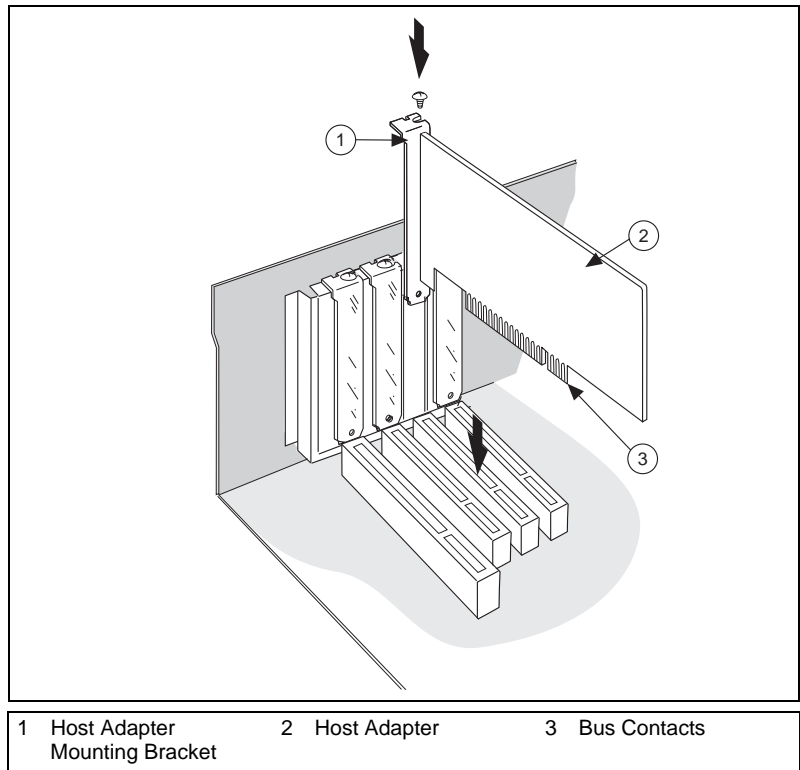

Figure 2-2. Installing the PCI-1394 Host Adapter

6. Carefully press the host adapter into the slot.
7. Secure the host adapter bracket to the computer chassis with the screw from the removed expansion slot cover.

Install Your VXI-1394 Interface Board

All kits contain a VXI-1394 interface module.

Install the VXI-1394 in Slot 0 of your VXI chassis by doing the following:

1. Turn off the power.
2. Insert the VXI-1394/G into the chassis in Slot 0. See Figure 2-1.
3. Turn on the power.

The VXI-1394 default configuration automatically detects whether it should be the VXI system controller. The VXI system controllers operate certain VXI lines as required for VXI systems. Verify that any other VXI devices with system controller capability that are located in the same chassis are *not* configured as system controller.



Caution Having more than one device configured as system controller can damage the VXI system.

For VXI systems that include VME devices, ensure that the VME devices are not configured in the upper 16 KB (starting from 0xC000) of the A16 address space. This region is reserved for VXI device configuration registers, which are used for initializing, configuring, and interacting with VXI devices. The VXI-1394 also uses this region for this purpose.



Note Also ensure that no VXI devices in your system are configured for logical address 0. This is the default configuration for the VXI-1394.

Connect Cables

Connect the IEEE 1394 cable to the PCI-1394 host adapter and to the VXI-1394, as shown in Figure 2-1 at the beginning of this section. You can use any available 1394 port for each device. The VXI-1394 has three external ports. The OHCI 1394 host adapter has three external ports.

You can connect any other 1394 devices to any available port on an existing device, but for best results minimize the number of levels in the tree topology. Adding to the number of levels in the tree degrades system performance.



Caution Do *not* cable devices to your 1394 system in such a way as to form a loop. Any device should have only one connection to the 1394 bus. An example of a loop would be a system containing a PCI-1394, a VXI-1394, and a device connected to both. Such a closed loop would break the 1394 system.

Some 1394 devices require different cables than others. Your kit includes one 6-to-6-pin cable to link the VXI-1394 to your computer. Some other devices such as a video conferencing camera, for example, also require a 6-to-6-pin cable for proper connection to the 1394 system. Many other devices such as camcorders, VCRs, and so on, take a 6-to-4-pin cable. If you have the VXI-1394/G option, use a GPIB cable to attach your GPIB instruments to the GPIB port on the VXI-1394/G.

Power on the System

1. Be sure all cables are connected securely.
2. Ensure that the VXI-1394 is turned on prior to starting the external computer.
3. Turn on the external computer.
4. **(PC systems)** If your system CMOS setup requires you to enable PCI bus parameters, do so at this time.



Note The PCI bus usually assigns IRQs and port addresses automatically. However, in some PC systems, you may need to manually edit the PCI bus parameters in your CMOS setup. Refer to your computer documentation for further instructions.

5. You can now turn on any external devices.

- ◆ **Windows 98 users**—When you power-on your computer after installing your hardware, Windows 98 will prompt you for the original Windows 98 CD for the IEEE 1394 host adapter drivers.

Software Configuration and Verification

VXI-1394/G Only — GPIB Configuration and Verification

Use the GPIB Getting Started Wizard to configure and verify the installation. Start the wizard by selecting **Start»Programs»National Instruments NI-488.2»Getting Started Wizard**. The wizard guides you through the necessary steps to first configure the software and then verify the NI-488.2 installation by using the Troubleshooting Wizard.



Note During configuration, the correct board type to select is VXI-1394/G.

All of the NI-488.2 utilities can be accessed through either Measurement & Automation Explorer (**Start»Programs»National Instruments NI-488.2»Explore GPIB**) or through the T&M Explorer

(Start»Programs»National Instruments VXI»T&M Explorer). T&M Explorer is the recommended way to access the utilities because it provides access to all of the NI-488.2, NI-VXI and NI-VISA utilities.

Run T&M Explorer and Resman

1. Run the T&M Explorer program. It prompts you to run Resman, the National Instruments Resource Manager. You must run Resman every time the chassis power is cycled so that your application can access devices in the VXI chassis. You can also configure T&M Explorer to run Resman automatically at every computer startup by selecting **Tools»Options and clicking the Resource Manager tab.**
2. After you run Resman, you are ready to use T&M Explorer to interactively configure the National Instruments hardware in your system. Use the right-click help for information about the various configuration options.

After you finish configuring the system through T&M Explorer, verify the configuration through one of the interactive control utilities. Use VIC under NI-VXI (**Start»Programs»National Instruments VXI»VIC**) or VISAIC under NI-VISA (**Start»Programs»VXIpn»Win32 VISA Interactive Control**).

Developing Your Application

This chapter discusses the software utilities you can use to start developing applications.

After installing and configuring your system, you can begin to develop your NI-VXI, NI-VISA, or NI-488.2 application software. Be sure to check the `readme.txt` file for the latest application development notes and changes.

Your software includes several utilities to help you develop your system. These include T&M Explorer, Resman, NI Spy, VISAIC, and VIC. You can also access several examples to learn how to use NI-VISA, NI-VXI, or NI-488.2 for certain tasks. Each of these components assists you with one of four steps of development: configuration, device interaction, programming, and debugging.

After installation, you can access these utilities through the Windows **Start** menu. For the NI-VXI or NI-VISA, use the utilities under **Start»Programs»VXIinp»** or **Start»Programs»National Instruments VXI**. For NI-488.2, use **Start»Programs»National Instruments NI-488.2»Explore GPIB** for access to all of the development and debugging utilities for NI-488.2.

Configuration

The configuration utilities in your kit include Resman and T&M Explorer. Resman is the application that performs VXI Resource Manager functions as described in the VXIbus specification. Its most important functions include configuring all devices on the VXI backplane for operation and allocating memory for devices that request it. Use the GPIB Configuration utility to configure your GPIB controller.



Note Because power cycling resets all devices, run Resman to reconfigure them every time chassis power is cycled.

T&M Explorer presents a graphical display of your entire test and measurement system to help you configure various components. When you launch T&M Explorer, you see all your VXI, GPIB, GPIB-VXI, and serial devices on the screen. You can add devices that cannot be detected dynamically by T&M Explorer through the **Add Device Wizard** in the **Edit** menu. Such devices include VME devices, certain GPIB devices, and serial ports. You can view the properties (such as logical address, address space used, primary address, and so on) of each device by right-clicking on the device in the tree. When you view the properties of most National Instruments devices, you can configure the hardware settings directly in the property pages.

T&M Explorer and Resman are designed to work together. You can run the Resource Manager through T&M Explorer by either clicking on the **Run Resource Manager** button on the toolbar, or selecting **Tools»VXI Resource Manager**. From **Tools»Options**, you can also configure T&M Explorer to run Resman automatically when the computer boots up. Resman reports all errors that it finds in your system to T&M Explorer. When you view your system through T&M Explorer, you can easily spot any errors in your system that Resman found.

You can find more information about T&M Explorer by using its online help. From T&M Explorer, select **Help»Help Topics**.

Device Interaction

After Resman has detected and configured all VXI/VME devices, you can view specific information on each device in your system by using the T&M Explorer utility. This utility includes a **System View**, which contains a description for each device, including each VXI device's logical address.

VISAIC and VIC

You can interact with your VXI/VME devices by using either the VIC or VISAIC utility (VIC for NI-VXI or VISAIC for NI-VISA). You can use these utilities to interactively control your VXI/VME devices without having to use a conventional programming language, LabVIEW, or LabWindows/CVI.



Note You can launch VIC or VISAIC from the Tools menu in T&M Explorer.

Try the following in VIC. In the **Command** entry field, type:
`help vxiiinreg`

This help file shows you the syntax for this command, which reads VXI device configuration registers. The first argument is a logical address, and the second is the offset of the VXI device configuration register to be read.

Type:

```
vxiiinreg 0,0
```

The **History** window shows the result of the command execution, such as:

Return Status (0): Success.

Value = 0xBFF6

If the value ends with FF6, you have successfully read the National Instruments manufacturer ID from the VXI-1394 ID register.

You may now want to read the configuration registers from other VXI devices in your system using the command `vxiiinreg`. This command accesses only the upper 16 KB of A16 space. Try reading a register from each of the devices listed in the **Connection View** of T&M Explorer. In this way, you can verify that your VXI-1394 can access each of the devices in your VXI system successfully.

You can also access VXI and VME devices that are configured in A16, A24, and A32 address space by using the `vxiiin` or `vxiiout` commands. For more information regarding VIC operation and commands, refer to the VIC online help.

Alternatively, you can use VISAIC to interact with your VXI, VME, GPIB and serial devices. VISAIC lists the available devices, similar to what T&M Explorer displays. By double-clicking on a given device, you can open a VISA session and access the device through it. For more information regarding VISAIC, use the right-click help available from all panels.

NI-488.2 Interactive Control

You can use the NI-488.2 Interactive Control utility to enter NI-488 functions and NI-488.2 routines interactively and see the values returned by the function calls. You can use the utility to do the following:

- Verify GPIB communication with your device quickly and easily
- Learn the NI-488 functions and NI-488.2 routines before you write your application
- Become familiar with the commands of your device

- Receive data from your GPIB device
- Troubleshoot problems with your application

Advanced Communication

For advanced interactive communication with GPIB instruments, use the Interactive Control utility, as follows:

1. Select **Start»Programs»National Instruments NI-488.2»Explore GPIB** to start Measurement & Automation Explorer.
2. Expand the **Devices and Interfaces** directory by clicking on the + next to the folder.
3. Right-click on your GPIB interface and select **Interactive Control** from the drop-down menu that appears.
4. At the command prompt, type NI-488.2 API calls to communicate interactively with the your instrument. For example, you might use `ibdev`, `ibclr`, `ibwrt`, `ibrdr`, and `ibonl`.

To view the online help for Interactive Control, type `help` at the Interactive Control command prompt.

Programming with VXI and GPIB

National Instruments provides three different programming interfaces for accessing your instruments: NI-VISA, NI-VXI, and NI-488.2. NI-VISA is the National Instruments implementation of the VISA API as defined by the *VXIplug&play* standard. It is very useful in situations where you have different types of instruments in your system—such as VXI, VME, GPIB, and serial devices—because the NI-VISA functions have the same interface.

NI-VXI is the National Instruments proprietary interface for programming VXI/VME instruments. Both NI-VXI and NI-VISA grant you register-level access of VXI instruments as well as messaging capability to message-based devices. With either interface you can service asynchronous events, such as triggers and signals, and also assert them.

NI-488.2 is the National Instruments industry-standard implementation of the ANSI/IEEE Standards 488.1-1987 and 488.2-1992. The original GPIB (General Purpose Interface Bus) specification, known as ANSI/IEEE Standard 488.1-1987, describes a standard interface for communication between instruments and controllers from various vendors. It contains information about electrical, mechanical, and functional specifications.

The GPIB is a digital, 8-bit parallel communications interface with data transfer rates of 1 Mbytes/s and above. The bus supports one System Controller, usually a computer, and up to 14 additional instruments. The ANSI/IEEE Standard 488.2-1992 extends IEEE-488.1 by defining a bus communication protocol, a common set of data codes and formats, and a generic set of common device commands.

The best way to learn how to program with NI-VXI and NI-VISA is by reviewing the example programs included in your software. In the `Examples` directory you will find examples for many different types of applications. If you are just getting started, you should first learn how to access registers with high-level calls and send messages with word serial functions. The NI-VXI examples are called `VXIhigh.c` and `VXIws.c`. The NI-VISA examples of these tasks are called `VISAhigh.c` and `VISAws.c`. Use the other examples as you try more advanced techniques. Consult the *NI-VXI User Manual*, the *NI-VISA User Manual*, or the GPIB online help for additional information on these topics.



Note The NI-VXI User Manual resides in the `NI-VXI\manuals` directory, and the NI-VISA User Manual is in the `VXIpnpc\os\NIvisa>manuals` directory, where `os` would be either `winNT` or `win95`. Use the Acrobat Reader program to open and navigate through the manuals. To access the GPIB online help, select **Start»Programs»National Instruments NI-488.2»Explore GPIB**, then choose **Help»Help Topics**.

Table 3-1 summarizes the topics addressed by the NI-VXI and NI-VISA example programs.

Table 3-1. NI-VXI/VISA Examples

Coverage	NI-VXI Example	NI-VISA Example
Message-Based Access	<code>VXIws.c</code>	<code>VISAws.c</code> , <code>ReadWrite.c</code>
High-Level Register Access	<code>VXIhigh.c</code>	<code>VISAhigh.c</code> <code>HighReg.c</code>
Low-Level Register Access	<code>VXIlow.c</code>	<code>VISAlow.c</code> <code>LowReg.c</code>
Sharing Memory	<code>VXImem.c</code>	<code>VISAmem.c</code> <code>ShareSys.c</code>

Table 3-1. NI-VXI/VISA Examples (Continued)

Coverage	NI-VXI Example	NI-VISA Example
Interrupt Handling	VXIint.c	VISAint.c AsynchAn.c SyncInte.c
Trigger Handling	VXItrig.c	VISAtrig.c SyncTrig.c



Note T&M Explorer includes special settings that you must use for memory sharing. Consult the T&M Explorer online help for information on setting these up.

Additional Compiler Information

When building an application with NI-VISA, you must include "visa.h" in your source code. In addition, you should link in the appropriate import library for your compiler.



Note LabWindows/CVI automatically includes the VISA library if it is needed. You do not need to explicitly link to the VISA import library when using LabWindows/CVI.

For the Microsoft C/C++ environment, use the `visa32.lib` in the `VXI\pnp\os\lib\msc` directory. For the Borland C/C++ environment, use the `visa32.lib` in the `VXI\pnp\os\lib\bc` directory. For example, if you are using Microsoft C/C++ with Windows NT and have installed NI-VISA into the default directory, you would normally specify `C:\VXI\pnp\WinNT\lib\msc\visa32.lib`.

When building an application with NI-VXI, you must include "nivxi.h" in your source code. In addition, you should link in the appropriate import library for your compiler.



Note LabWindows/CVI automatically includes the VXI library if it is needed. You do not need to explicitly link to the NI-VXI import library when using LabWindows/CVI.

For the Microsoft C/C++ environment, use the `nivxint.lib` in the `NIVXI\win32\msc` directory. For Borland C/C++, use the `nivxint.lib` in the `NIVXI\win32\borlandc` directory. For example, if you are using Microsoft and have installed NI-VXI into the default directory, you would normally specify `C:\NIVXI\msc\nivxint.lib`.

Refer to the documentation that came with your compiler package for detailed instructions about using the compiler and the various tools (linker, debugger, and so on). Your compiler documentation is an important and useful source of information for writing, compiling, and debugging C programs.

Shared Memory

The VXI-1394 supports sharing of onboard VXI-1394 RAM in VXI space. However, it does not support sharing of the local PC memory. Refer to T&M Explorer online help for more information.

Additional Software Notes

This section describes additional software options you may want to consider.

Compatibility

NI-VXI applications that follow the guidelines documented in the *NI-VXI User Manual* will work with NI-VXI for the VXI-1394.

System Configuration Functions

The `InitVXIlibrary()` function has a new return value of `INIT_RET_OK_RMERROR (2)`. If this value is returned, it means “The NI-VXI library successfully initialized, but the Resource Manager has not been run successfully.” Always run the Resource Manager before using the NI-VXI library, even if you are using only VME.

Low-Level VXIbus Access Functions

Do not make any assumptions about the size and features of a window returned from `MapVXIAddress()`. You should use `GetWindowRange()` to determine the size of a window. The 32-bit value returned from `GetContext()` and passed to `SetContext()` has a new format. Applications that set the context bits directly for use in `SetContext()` may not be compatible with the new format for context. Because the MITE allows more flexible window mapping, extra bits have been added to this field to reflect these new features. Do not manipulate the context bits directly.

High-Level VXIbus Access Functions

For best performance, keep the following in mind when using `VXImove()`:

- Make sure your buffers are 32-bit aligned.
- Transfer 32-bit data whenever possible.
- Using VXI/VME block access privileges significantly improves performance to devices that are capable of accepting block transfers.
- `VXImove()` must lock the user buffer in memory on virtual memory systems, so locking the buffer yourself optimizes `VXImove()`.
- Because `VXImove()` must build a scatter-gather list for the user buffer on paged memory systems, using a contiguous buffer optimizes `VXImove()`.

`VXImove()` can also move blocks of data to and from a single VXI/VME address. This is commonly referred to as *FIFO mode*. For more information, refer to the *NI-VXI Programmer Reference Manual*.

Notes about VME Support

To use VME devices in your system, configure NI-VXI to see these devices by using the **Add Device Wizard** in T&M Explorer. VME devices with two blocks of memory in the same address space require two entries. You can also specify which interrupt levels the device uses. VXI and VME devices cannot share interrupt levels. You can then access the VME device from NI-VXI or NI-VISA just as you would a register-based VXI device, by specifying the address space and the offset from the base at which you have configured it. NI-VISA support for VME devices includes the register access operations (both high-level and low-level) and the block move operations, as well as the ability to receive interrupts.

Debugging

National Instruments provides several useful utilities that can aid in identifying the causes of problems in your application. These utilities include NI Spy, VISAIC, VIC, and the NI-488.2 Troubleshooting Wizard.

NI Spy

NI Spy tracks the calls your application makes to National Instruments T&M drivers including NI-VISA, NI-VXI, and NI-488.2. This utility highlights functions that return errors, so you can quickly spot which functions failed during your development. NI Spy can log the calls your program makes to these drivers so you can check them for errors at your convenience.

VISAIC and VIC

You can also control your instruments interactively using VISAIC and VIC. You can use VISAIC to control and communicate with your instruments with NI-VISA without having to write a program. VIC gives you a similar environment that uses NI-VXI. These utilities are an excellent platform for quickly testing instruments and learning how to communicate with them.



Note VISAIC finds all VXI, VME, GPIB, and serial instruments in your system. VIC recognizes only VXI and VME instruments, not GPIB or serial instruments.

Refer to the online help for instructions on how to use VIC or VISAIC and to learn about their features. In VIC, click on the ? button (located next to the **Go** button) to get help for that page, or type `help`. You can also right-click on a component on the screen to access **What's This** help. In VISAIC, you can right-click to reach **What's This** help and function help.

NI-488.2 Troubleshooting Wizard

To troubleshoot NI-488.2 problems, run the NI-488.2 Troubleshooting Wizard:

1. Select **Start»Programs»National Instruments NI-488.2»Explore GPIB**.
2. Start the NI-488.2 Troubleshooting Wizard by choosing **Help»Troubleshooting»NI-488.2 Troubleshooting Wizard**.

Specifications

This appendix lists the specifications for the VXI-1394 and VXI-1394/G modules.

Requirements

VXIbus configuration space..... 64 B
A24 or A32 space..... Programmable
Default None

Environmental

Temperature
Operating 0 to 55 °C
Storage -20 to 70 °C

Relative humidity
Operating 10% to 90% noncondensing
Storage 5% to 95% noncondensing

EMI FCC Class A verified, EC verified

Functional shock
MIL-T-28800E Class 3 (30 g half-sine shock pulse)
Also meets IEC 60068-2-27

Random vibration
MIL-T-28800E, MIL-STD-810E Category 1
Operational 5 to 500 Hz, 0.3 g_{rms}
Non-operational 5 to 500 Hz, 2.4 g_{rms}

Power Requirement

+5 V	
Typical.....	2.23 A
Maximum (fused).....	7 A
-5.2 V	
Typical.....	176 mA
Maximum (fused).....	1 A
-2 V	
Typical.....	89.5 mA
Maximum (fused).....	1 A
+12 V	
Typical.....	750 μ A
Maximum (fused).....	1 A

Physical

Dimensions	
Fully enclosed, shielded VXI C-size board	
233.35 by 340 mm (9.187 by 13.386 in.)	
Weight	
VXI-1394.....	1.11 kg (2.45 lb.)
(No DRAM installed)	
VXI-1394/G.....	1.15 kg (2.53 lb.)
(No DRAM installed)	
I/O connectors	
6-pin 1394.....	3
SMB.....	3
GPIB (optional).....	1
Slot requirements.....	Single VXI C-size slot
Compatibility.....	Fully compatible with VXI specification
VXI keying class.....	Class 1 TTL
MTBF.....	Contact factory

IEEE 1394 Capability Descriptions

Speed support	100, 200, 400 Mb/s
Protocol support	Asynchronous Quadlet and Block
Data payload packet sizes	Up to 2048 bytes
Asynchronous Target and Initiator	

VMEbus Capability Codes

A32, A24, A16 (master)	VMEbus master A32, A24, and A16 addressing
A32, A24, A16 (slave)	VMEbus slave A32, A24, and A16 addressing
D64, D32, D16, D08(EO) (master)	VMEbus master D64, D32, D16, and D08 data sizes
D64, D32, D16, D08(EO) (slave)	VMEbus slave D64, D32, D16, and D08 data sizes
BLT, MBLT (master)	VMEbus master block and D64 transfers
BLT, MBLT (slave)	VMEbus slave block and D64 transfers
RMW (master)	VMEbus master read/modify/write transfers
RMW (slave)	VMEbus slave read/modify/write transfers
RETRY (master)	VMEbus master retry support
RETRY (slave)	VMEbus slave retry support
FSD	First slot detector
SCON	VMEbus System Controller (Automatic Detection)

PRI, RRS

Prioritized or Round Robin Select arbiter

ROR, FAIR

Release on Request and FAIR bus requester

IH(7-1)

Interrupt handler for levels 7-1

I(7-1)

Interrupt requester for levels 7-1

D32, D16, D08(O) (Interrupt Handler)

VMEbus D32, D16, D08(O) interrupt handler

D32, D16, D08(O) (Interrupter)

VMEbus D32, D16, D08(O) interrupter

ROAK, RORA

Release on Acknowledge or Register Access interrupter

BTO(x)

VMEbus bus timer (programmable limit)

LOCK

Can lock the VMEbus for indivisible transfers

Default Settings

This appendix summarizes the default settings for the hardware and software in the VXI-1394 kit. If you need more information about a particular setting, or if you want to try a different configuration, please refer to Appendix C, *Advanced Hardware Configuration Settings*, for your hardware reference and to the T&M Explorer online help for your software reference.



Note There are no hardware settings on the PCI-1394 board.

Hardware Settings

Table B-1. VXI-1394 Hardware Default Settings

Hardware Component	Default Setting
W1—VXIbus Slot 0/Non-Slot 0	Automatic detection
S6—VXIbus CLK10 source	From onboard oscillator
S5—External trigger termination	OFF: unterminated
S3—SMB CLK10 direction	IN: receive CLK10 signal
S2—SMB CLK10 termination	OFF: ignored
S4—Polarity of external SMB CLK10	Inverted
S7—Configuration EEPROM	Do <i>not</i> load from factory setting
DRAM SIMMs installed	Per customer order

Software Settings

Table B-2. T&M Explorer Device Tab Default Settings

Editor Field	Default Setting
Logical address	0
Device class	Message based
Size of Servant area	0
System interrupt level	Disabled
Number of handlers	1
Number of interrupters	0

Table B-3. T&M Explorer Shared Memory Tab Default Settings

Editor Field	Default Setting
Memory sharing	Don't share memory
Shared RAM size	A16—none A24—256 B A32—64 KB
Reserved physical memory	0
Lower half window byte swapping	Disabled
Upper half window byte swapping	Disabled
Map upper and lower halves at same PCI address	Disabled

Table B-4. T&M Explorer VXI Bus Tab Default Settings

Editor Field	Default Setting
Bus timeout value	125 μ s
VXI retry generation	Enabled
Automatic retries	Disabled
A24/A32 write posting	Disabled
Transfer limit	256
Requester mode	Release on Request
Request level	3
Fair requester	Enabled
Bus arbitration mode	Prioritized
Arbiter timeout	Enabled



Advanced Hardware Configuration Settings

This appendix describes the factory-default and alternate hardware configuration settings of the VXI-1394. The board is set at the factory for the most commonly used configuration. Use this appendix if you want to try a different hardware configuration, or if you would like more information on a particular setting. This information is intended for more advanced users.

Hardware Default Settings

The following hardware configuration settings are user configurable:

- VXIbus Slot 0/Non-Slot 0
- Configuration EEPROM
- VXIbus CLK10 routing
- Trigger input termination

Figure C-1 shows the factory-default settings of the user-configurable jumper and switches on the VXI-1394. The slot selection jumper and six switches are located in the corner of the board behind the front panel SMB connectors.



Note Do *not* attempt an alternate setting unless you are familiar with its purpose. In addition, do not reconfigure any switches or jumpers not described in this appendix unless directed by National Instruments support.

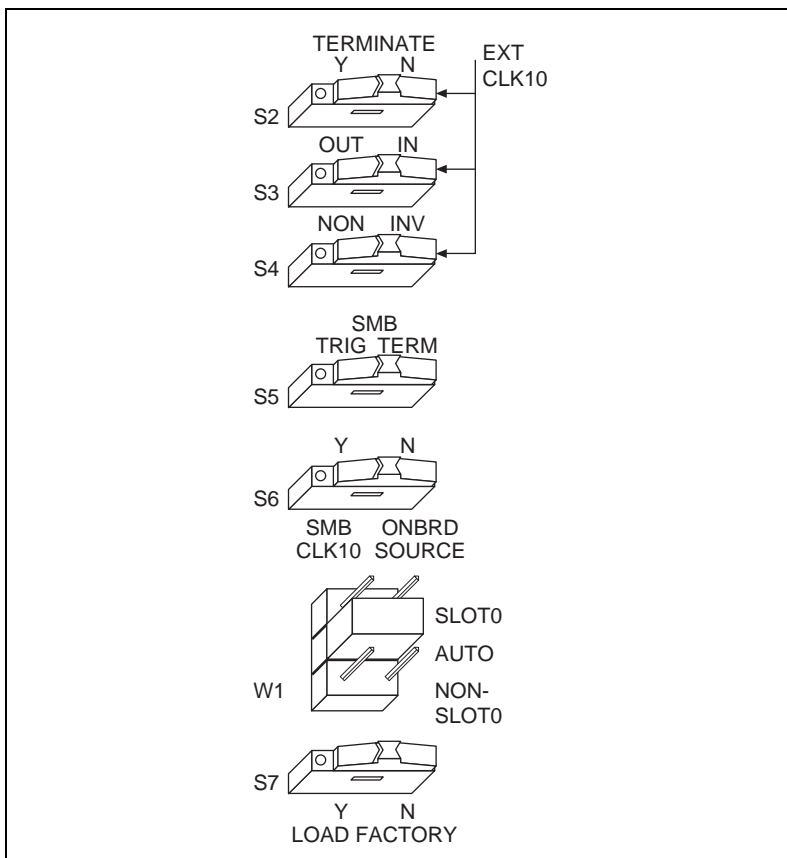

Figure C-1. VXI-1394 Default Configuration Settings

VXIbus Slot 0/Non-Slot 0

The VXI-1394 is configured at the factory to automatically detect if it is installed in Slot 0 of a VXIbus mainframe. With automatic Slot 0 detection, you can install the VXI-1394 into any VXIbus slot.

You can manually configure the VXI-1394 for either Slot 0 or Non-Slot 0 operation by defeating the automatic-detection circuitry. Use the three-position jumper W1 to select automatic Slot 0 detection, Slot 0, or Non-Slot 0 operation. Figure C-2 shows these three settings.



Caution Do not install a device configured for Slot 0 into another slot without first reconfiguring it to either Non-Slot 0 or automatic configuration. Neglecting to do this could damage the device, the VXIbus backplane, or both.



Note The setting of any switch shown with this pattern (▨) has no bearing on the configuration described in any of the following figures. For example, Figure C-2 shows switch S7 merely because of its close proximity to W1.

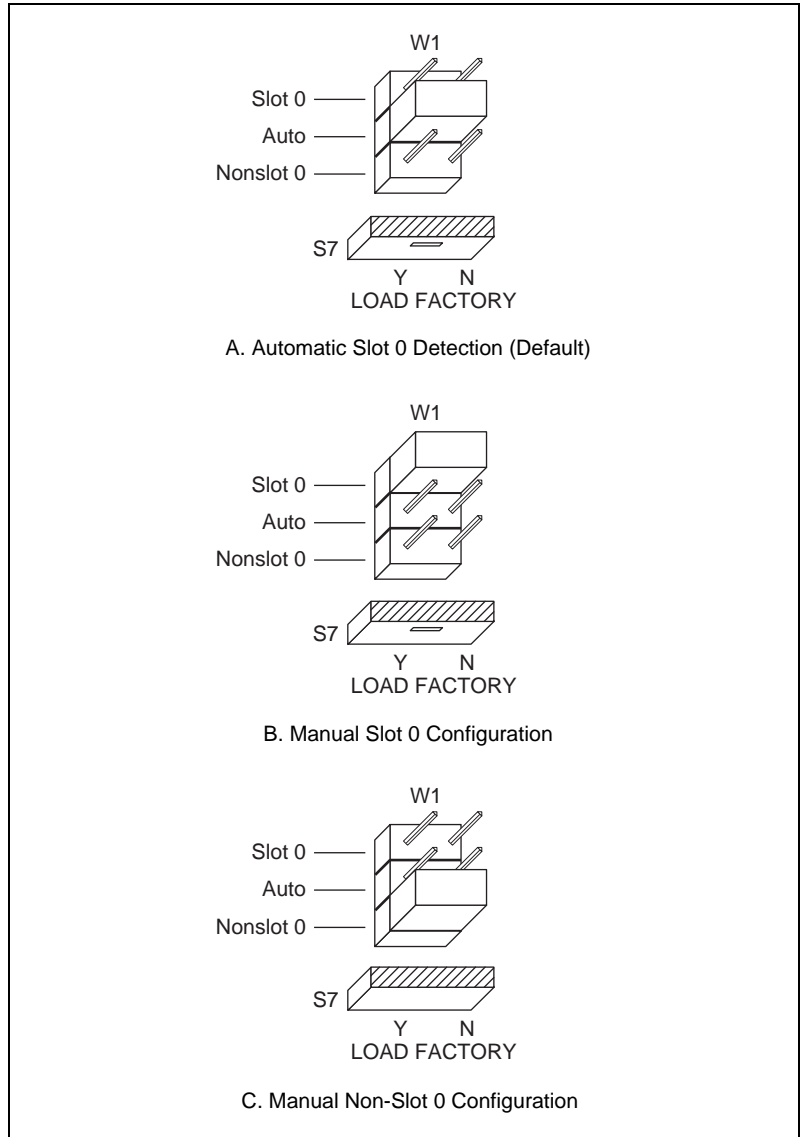

Figure C-2. VXIbus Slot Configuration

When the VXI-1394 is installed in Slot 0, it becomes the VXIbus System Controller. In this role, it has VXIbus Data Transfer Bus Arbiter circuitry that accepts bus requests on all four VXIbus request levels, prioritizes the requests, and grants the bus to the highest priority requester. As VXIbus System Controller, the VXI-1394 also uses an onboard 16 MHz oscillator to drive the 16 MHz VXIbus system clock.

As required by the VXIbus specification, the VXI-1394 drives the 10 MHz signal CLK10 on a differential ECL output when installed in Slot 0. When not installed in Slot 0, the VXI-1394 only receives the CLK10 signal.

Configuration EEPROM

The VXI-1394 has an onboard EEPROM, which stores default register values that are loaded at power-on. The EEPROM is divided into two halves—a factory-configuration half, and a user-configuration half. Both halves were factory configured with the same configuration values so you can modify the user-configurable half, while the factory-configured half stores a back-up of the default settings.

The Load Factory switch (switch S7) causes the VXI-1394 to boot off the factory-configured half instead of the user-modified settings. This is useful in the event that the user-configured half of the EEPROM becomes corrupted in such a way that the VXI-1394 boots to an unusable state.

Figure C-3 shows the configuration settings for EEPROM operation.

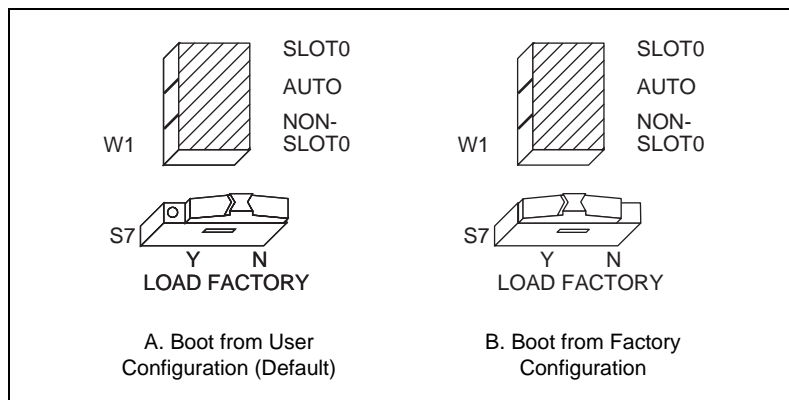



Figure C-3. EEPROM Operation

VXIbus CLK10 Routing

When the VXI-1394 is installed in Slot 0 of your mainframe, it supplies the VXIbus CLK10 signal. The VXI-1394 has four hardware switches that work together to control various aspects of CLK10 routing. Please read this section carefully and notice that if you change one switch, you may need to change another. This section includes several diagrams that show how to configure the four switches to accomplish various CLK10 configurations.

Conversely, the configuration of one switch may make the setting of another switch irrelevant. For example, only switches S3 and S4 are relevant if you install the VXI-1394 in a slot other than Slot 0. The drawings use the  pattern to depict switches that are either irrelevant or disabled for a particular CLK10 configuration.

Switch S5 uses this pattern in all of the CLK10 drawings. It deals with the external trigger input SMB and is discussed later in this appendix.

The VXI-1394 can use two different sources to generate the VXIbus CLK10 signal—an onboard oscillator or the external CLK SMB connector. Use switch S6 to select between these options. The VXI-1394 uses the onboard oscillator by default.

The VXI-1394 can also be configured to drive the external CLK SMB from the VXIbus CLK10 signal. Switch S3 controls whether the VXI-1394 drives or receives the external CLK SMB. If you change the S3 setting to drive CLK10 out the external CLK10 SMB connector, do not set switch S6 to receive the SMB CLK10 signal; instead use its default setting so that the onboard oscillator generates the signal.

You can use an additional switch, S4, to control the polarity of the external CLK SMB signal when S3 is configured to drive it. S4 is unused—its setting is irrelevant—when S3 is configured to receive the external CLK SMB signal.

When switch S3 is set so that the VXI-1394 receives the SMB CLK10 signal, you have the option to add a 50 Ω termination to the signal by setting switch S2. S2 is unused—its setting is irrelevant—when S3 is configured to drive the external CLK SMB signal.

Figure C-4 shows the default settings for the CLK10 switches. This configuration is as follows:

- CLK10 is generated from the onboard oscillator (S6).
- The CLK10 signal is not terminated (S2).
- The VXI-1394 receives the external CLK10 signal (S3).
- The polarity of the CLK10 signal (S4) is irrelevant when the VXI-1394 receives the external CLK10 signal. However, it is configured to be inverted when the CLK10 SMB is used as output.

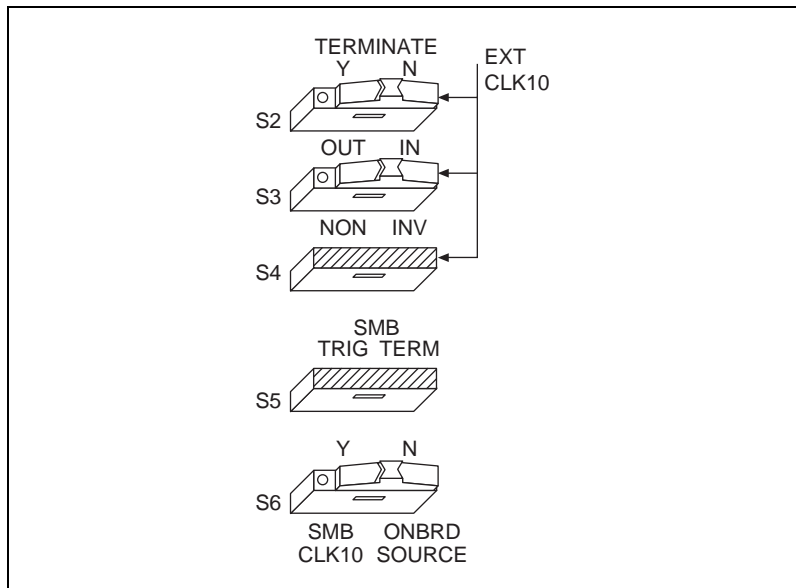

Figure C-4. Receive External CLK SMB (Default)

The configuration in Figure C-5 adds a 50 Ω termination to the signal by changing switch S2.

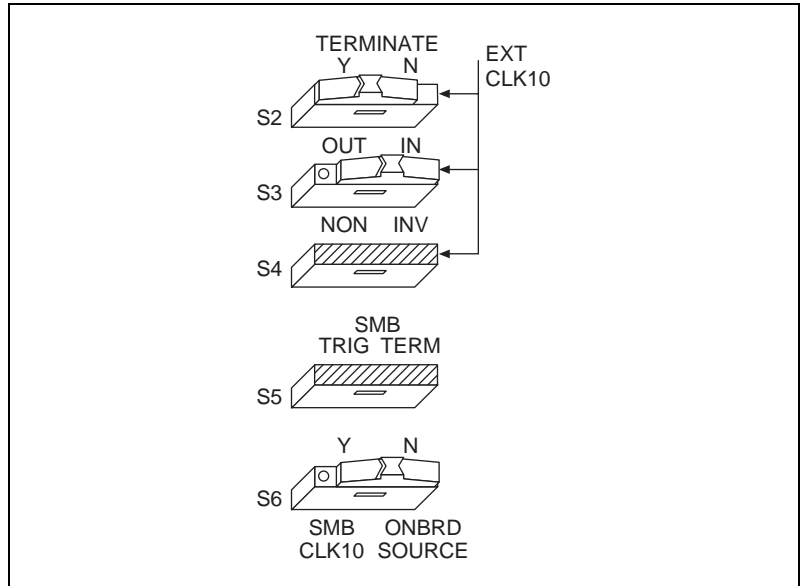

Figure C-5. Receive External CLK SMB with 50 Ω Termination

In Figures C-6 and C-7, switch S6 uses the alternate configuration to generate the VXIbus CLK10 signal. Instead of the onboard oscillator, the VXI-1394 generates from the external CLK SMB connector and drives to the backplane. You can choose whether to terminate the signal using S2. Polarity remains irrelevant to these configurations.

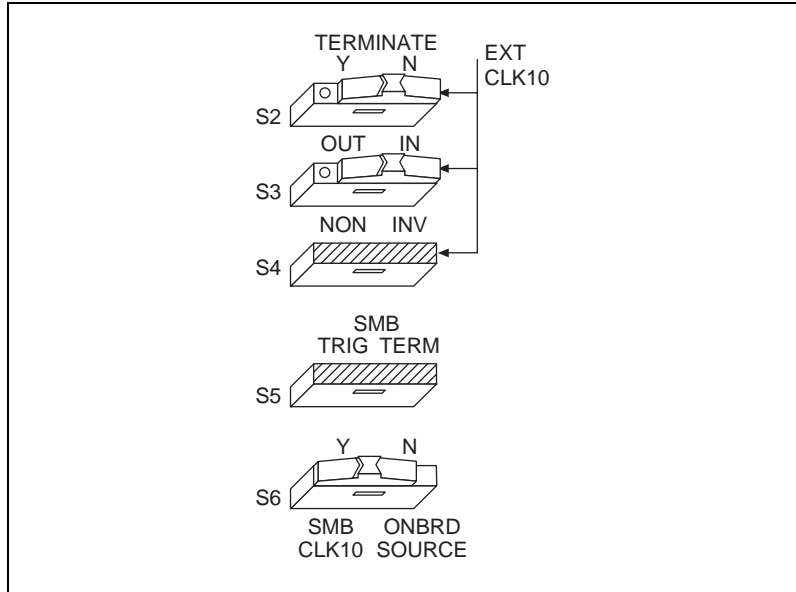

Figure C-6. Receive External CLK SMB and Drive to the Backplane Unterminated

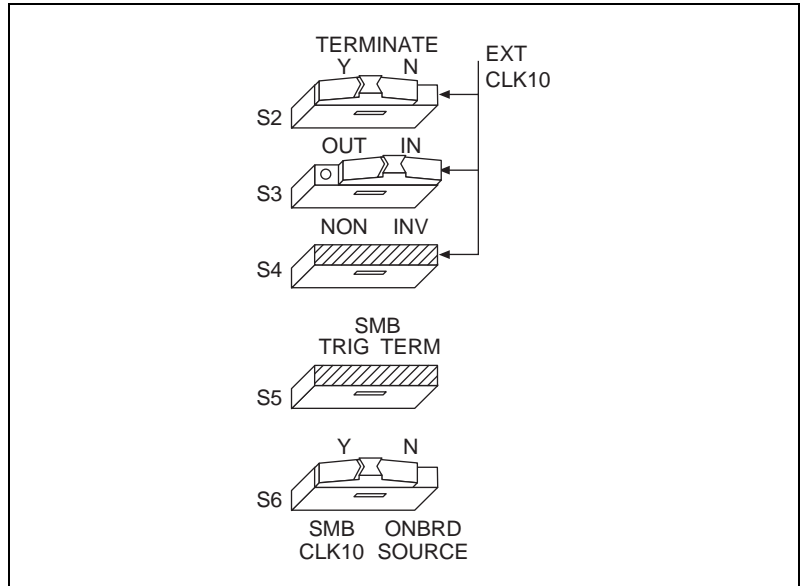

Figure C-7. Receive External CLK SMB with 50 Ω Termination and Drive to the Backplane

Figures C-8 and C-9 show two configurations for driving the external CLK SMB from the VXIbus CLK10 signal by changing switch S3 to its alternate setting. Switch S6 must be in its default position for these configurations. Signal termination is not an issue when driving the signal, so the position of S2 does not matter. The difference between these two configurations is whether to use inverted or non-inverted polarity when driving the signal.

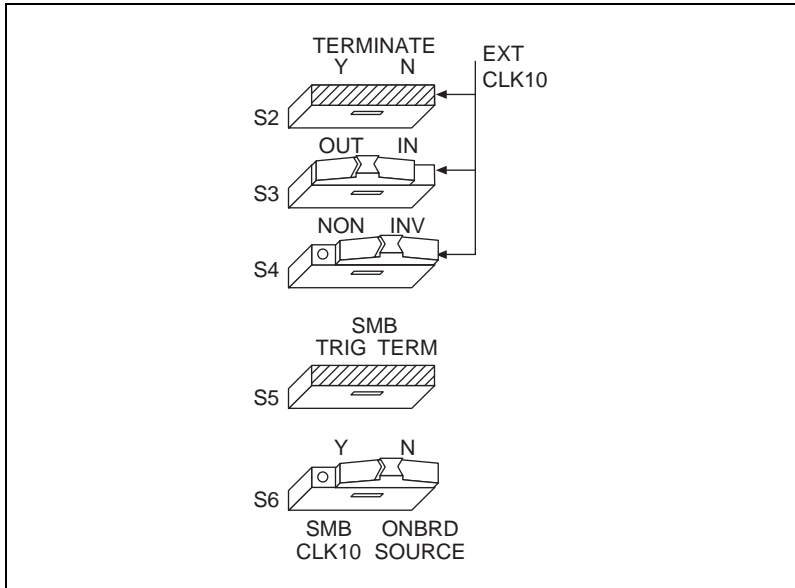

Figure C-8. Drive Inverted External CLK SMB

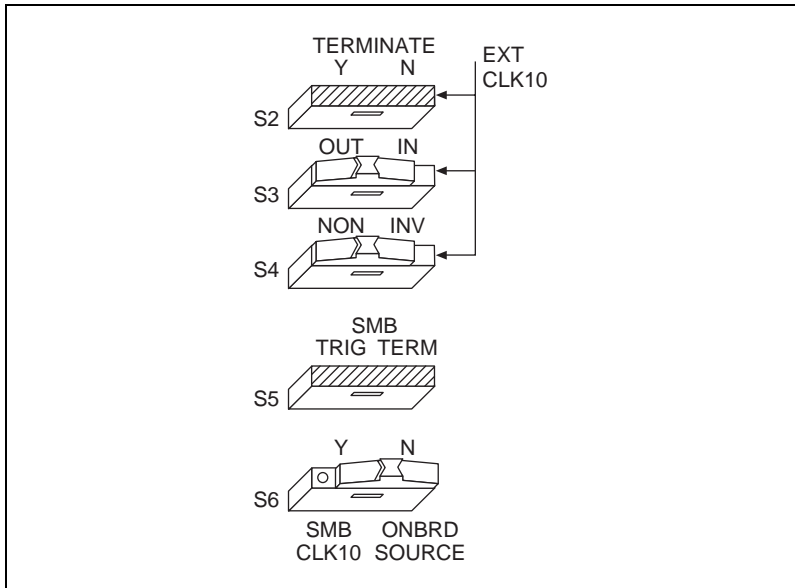

Figure C-9. Drive Non-Inverted External CLK SMB

Trigger Input Termination

Located within the group of CLK10 switches is switch S5, which controls whether to put a 50 Ω termination on the external trigger input SMB.

Figure C-10A shows the default setting for a non-terminated trigger input SMB. Use the setting of Figure C-10B to terminate the trigger input SMB.

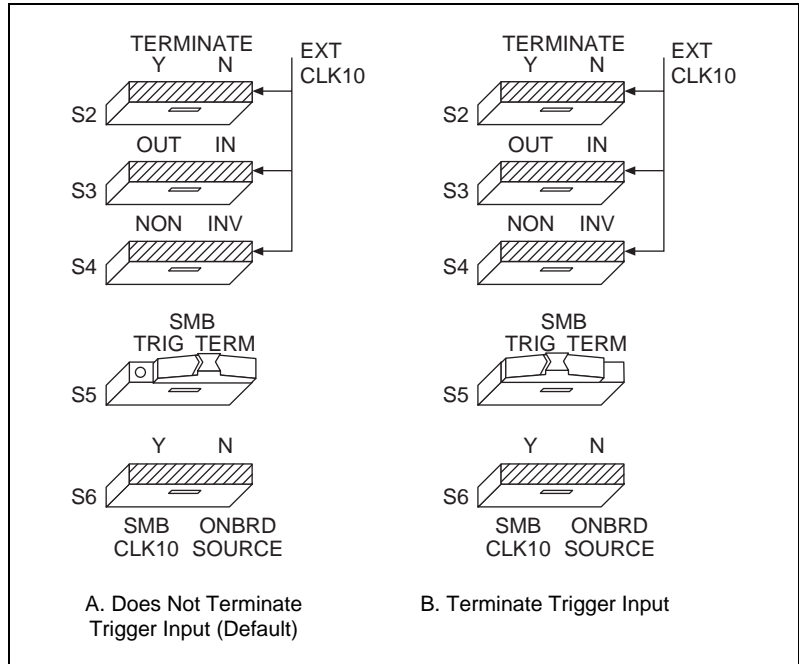

Figure C-10. SMB Trigger Input Termination

Common Questions

This appendix addresses common questions you may have about using the NI-VXI/VISA/488.2 software on the VXI-1394 platform.

Why won't my VXI-1394 work with my 1394 host adapter or built-in 1394 bus?

Windows 98 includes built-in support for 1394 based on the OHCI specification. OHCI is relatively new, so hardware from some manufacturers may not comply fully with the specification. The National Instruments PCI-1394, available separately or with the VXI-1394 kit, works with both the Windows 98 built-in support and Windows NT (using the driver included with your PCI-1394). Contact National Instruments for more information.

What does *hot plugging* mean in terms of IEEE 1394?

The concept of hot plugging in 1394 means that you can remove and insert 1394 cables without powering down your computer and devices. The 1394 Plug and Play architecture is designed so that the host computer can recognize when to load and remove the appropriate drivers. However, notice that inserting or removing any 1394 cable results in an interrupt condition on all devices, which may adversely affect any applications using the VXI-1394 at that time. For that reason, we recommend closing all 1394-related applications before changing your 1394 bus configuration, and running Resource Manager after adding any new 1394 devices to your system.

Does it matter whether I plug in a 1394 device to the PCI-1394 in my computer or to the VXI-1394 in my mainframe?

The only difference is the topology of the system. If your system consists of a PC connected to a VXI-1394 which is in turn connected to a digital camera, you can get the best performance by connecting a third peripheral to the VXI-1394 rather than to the PC or the digital camera. This restricts the maximum distance between any two nodes to two cable segments.

Connecting the third peripheral to either the PC or the digital camera would create a maximum distance of three cable segments between any two nodes.

Use only a tree topology to build your system. A closed loop is illegal, and will not work. For example, if you have a PCI-1394 and a VXI-1394 cabled together and you add direct connections from both of them to the same digital camera, you create a closed loop. A 1394 device should have only one connection to the 1394 system.

Can I control the VXI chassis through the GPIB port on the VXI-1394/G module?

You can control the VXI chassis only through the 1394 bus. The GPIB port is used only for controlling other GPIB devices.

Can I have both a PCI-MXI-2 and a PCI-1394 interface in the same computer?

Yes, but only one of them can be used. Depending on your version of the software, the NI-VXI software will recognize only one of the boards as your VXI interface.

Can I have both a PCI-GPIB and a VXI-1394/G in the same computer?

Yes. Just be sure to assign each board a unique name. For example, if the PCI-GPIB is listed as **GPIB0**, assign some other name (such as **GPIB1**) to the VXI-1394/G using the GPIB Configuration Utility.

Which 1394 adapters will work with the VXI-1394 and VXI-1394/G?

Windows 98 includes built-in support for 1394 based on the OHCI specification. The National Instruments PCI-1394 works with both the Windows 98 built-in support and provides an OHCI driver for Windows NT 4.0. Contact National Instruments for more information if you encounter compatibility issues with your host adapter.

I need more devices than can fit in one chassis. How can I expand my VXI-1394 system?

Although it is physically possible to plug in another VXI-1394, software does not currently support this option. The recommended strategy is to use a VXI-MXI-2, which follows the VXI-6 specification for mainframe extension. This extends full VXI functionality across multiple mainframes, including a common device address space and interframe triggering, interrupts, and bus mastering. Place a VXI-MXI-2 in the same frame as the

Slot 0 VXI-1394, and another VXI-MXI-2 in Slot 0 of the next mainframe. You can then fill up this mainframe with additional devices.

If you have additional GPIB devices to add to the system—such as a GPIB-VXI/C controller in Slot 0 of another VXI chassis—the VXI-1394/G comes with a built-in GPIB controller so that you can connect GPIB devices directly off the VXI-1394/G without the need for a GPIB controller in your host computer.

How can I determine the serial number and hardware revision of the VXI-1394 board?

Run T&M Explorer and right-click on the name of the VXI-1394 board. Select **Hardware Configuration**, and the dialog box for the VXI-1394 board is displayed. The title bar includes the serial number and hardware revision of the board.

What is Resman?

Resman is the name of the utility that performs the duties of a VXI Resource Manager as discussed in the VXIbus specification. When you set a National Instruments controller to Logical Address 0, you will at some point need to run Resman to configure your VXI instruments. If your controller uses a different (non-zero) logical address and is a message-based device, you need to start Resman before running it on the Logical Address 0 computer.

When do I need to run Resman?

Run Resman whenever you need to configure your VXI instruments. For example, if you power-cycle your VXI chassis, your instruments will be reset, and you will need to run Resman to configure them. You can get into trouble if you run Resman when your devices are not in a reset state. Therefore, if you have to run Resman after running it once, you should reset all of your VXI instruments.

You can perform resource manager operations from within T&M Explorer after you install the VXI-1394 and cable it to your computer. With the VXI-1394, you may need to run the Resman utility if you boot your computer before turning on your VXI chassis or if you power-cycle your VXI chassis while the external PC remains on. In these cases, the instruments would have been reset without the computer rebooting. You will need to run the Resman utility or configure your system in T&M Explorer to initialize your VXI system.

Which NI-VXI utility program must I use to configure the VXI-1394?

Use the T&M Explorer program to configure the VXI-1394. T&M Explorer is located in the NIVXI and VXI_{PNP} program group folders.

Use the Measurement & Automation Explorer to configure your GPIB system.

Which NI-VXI utility program must I use to initialize the VXI-1394?

The VXI-1394 initializes itself at chassis power-up.

How do I handle VME devices?

Although there is no way to automatically detect VME devices in a system, you can add them easily through the **Add Device Wizard** in T&M Explorer. Through this procedure, you can reserve resources for each of your VME devices and configure T&M Explorer to show VME devices on the screen with all your other devices.

Which NI-VXI utility program must I use to perform startup Resource Manager operations?

Use the Resman program to perform startup Resource Manager operations. It is located in the NIVXI directory. Resman uses the settings configured in T&M Explorer. It initializes your VXI/VMEbus system and stores the information that it collects in the RESMAN.TBL file in the TBL subdirectory of the NIVXI directory.

You can also run Resource Manager operations from T&M Explorer. Through T&M Explorer, you can also configure Resman to run automatically at computer startup.

What can I do to make sure that my system is up and running?

The fastest method for testing the system is to run Resman. This program attempts to access memory in the upper A16 address space of each device in the system. If Resman does not report any problems, the VXI-1394 communication system is operational.

To test individual devices, you can use the VIC or VISAIC program to interactively issue NI-VXI functions or NI-VISA operations, respectively. You can use the VXIin() and VXIout() functions or the VXIinReg() and VXIoutReg() functions to test register-based devices by programming their registers. If you have any message-based devices, you can send and receive messages with the WSwrt() and WSRd() functions.

Notice that `VXIInReg()` and `VXIOutReg()` are for VXI devices only, but you can use `VXIIn()` and `VXIOut()` for both VXI and VME.

Finally, if you are using LabVIEW or LabWindows/CVI and you have instrument drivers for the devices in your chassis, you can use the interactive features of these programs to quickly test the functionality of the devices.

What should I do if I get a Configuration EEPROM is Invalid message?

There are several reasons why you might get the **Configuration EEPROM is Invalid** message. If you turned off the VXI chassis while the configuration update process was still in progress, the board functions normally except when running T&M Explorer. To correct these problems, reboot the VXI chassis with the Load Factory switch set (as described in Appendix C, *Advanced Hardware Configuration Settings*) and update the configuration, or load the configuration from file.

What do the LEDs on the front of the VXI-1394 mean?

- The **SYSFAIL** LED shows the state of the VXI/VMEbus SYSFAIL line. This line is asserted whenever any device in the chassis has not yet passed its self test, if it has failed its self test, or if it has detected a failure after originally passing its self test.
- The **1394** LED indicates that the VXI-1394 is being accessed by another device on the IEEE 1394 bus, such as when the computer communicates with either the VXI-1394 or another device in the chassis.
- The **VXI** LED, when lit, indicates that the VXI-1394 is being accessed by another device in the VXI chassis, such as when a bus master inside the chassis wants to talk to either the VXI-1394 or memory in the computer.

What kind of signal is CLK10 and what kind of signal do I need for an external CLK10?

CLK10 is a differential ECL signal on the VXIbus backplane. However, the oscillator for the VXI-1394 and the EXTCLK input from the front panel use TTL. Therefore, supply a TTL-level signal for EXTCLK, and our voltage converters will convert the signal to differential ECL.

What is the accuracy of the CLK10 signal?

The CLK10 generated by the VXI-1394 is 100 ppm (0.01%) as per the VXIbus specification. If you need a more accurate CLK10 signal, you can use the EXTCLK input at the front of the VXI-1394.

What is shared memory and dual-ported memory?

These terms refer to a block of memory that is accessible to both a client and a server. The memory block operates as a message buffer for communications. Shared memory is applicable only if you are using either A24 or A32 address space.

Technical Support Resources

This appendix describes the comprehensive resources available to you in the Technical Support section of the National Instruments Web site and provides technical support telephone numbers for you to use if you have trouble connecting to our Web site or if you do not have internet access.

NI Web Support

To provide you with immediate answers and solutions 24 hours a day, 365 days a year, National Instruments maintains extensive online technical support resources. They are available to you at no cost, are updated daily, and can be found in the Technical Support section of our Web site at www.ni.com/support

Online Problem-Solving and Diagnostic Resources

- **KnowledgeBase**—A searchable database containing thousands of frequently asked questions (FAQs) and their corresponding answers or solutions, including special sections devoted to our newest products. The database is updated daily in response to new customer experiences and feedback.
- **Troubleshooting Wizards**—Step-by-step guides lead you through common problems and answer questions about our entire product line. Wizards include screen shots that illustrate the steps being described and provide detailed information ranging from simple getting started instructions to advanced topics.
- **Product Manuals**—A comprehensive, searchable library of the latest editions of National Instruments hardware and software product manuals.
- **Hardware Reference Database**—A searchable database containing brief hardware descriptions, mechanical drawings, and helpful images of jumper settings and connector pinouts.
- **Application Notes**—A library with more than 100 short papers addressing specific topics such as creating and calling DLLs, developing your own instrument driver software, and porting applications between platforms and operating systems.

Software-Related Resources

- **Instrument Driver Network**—A library with hundreds of instrument drivers for control of standalone instruments via GPIB, VXI, or serial interfaces. You also can submit a request for a particular instrument driver if it does not already appear in the library.
- **Example Programs Database**—A database with numerous, non-shipping example programs for National Instruments programming environments. You can use them to complement the example programs that are already included with National Instruments products.
- **Software Library**—A library with updates and patches to application software, links to the latest versions of driver software for National Instruments hardware products, and utility routines.

Worldwide Support

National Instruments has offices located around the globe. Many branch offices maintain a Web site to provide information on local services. You can access these Web sites from www.ni.com/worldwide

If you have trouble connecting to our Web site, please contact your local National Instruments office or the source from which you purchased your National Instruments product(s) to obtain support.

For telephone support in the United States, dial 512 795 8248. For telephone support outside the United States, contact your local branch office:

Australia 03 9879 5166, Austria 0662 45 79 90 0, Belgium 02 757 00 20,
Brazil 011 284 5011, Canada (Calgary) 403 274 9391,
Canada (Ontario) 905 785 0085, Canada (Québec) 514 694 8521,
China 0755 3904939, Denmark 45 76 26 00, Finland 09 725 725 11,
France 01 48 14 24 24, Germany 089 741 31 30, Greece 30 1 42 96 427,
Hong Kong 2645 3186, India 91805275406, Israel 03 6120092,
Italy 02 413091, Japan 03 5472 2970, Korea 02 596 7456,
Mexico (D.F.) 5 280 7625, Mexico (Monterrey) 8 357 7695,
Netherlands 0348 433466, Norway 32 27 73 00, Poland 48 22 528 94 06,
Portugal 351 1 726 9011, Singapore 2265886, Spain 91 640 0085,
Sweden 08 587 895 00, Switzerland 056 200 51 51,
Taiwan 02 2377 1200, United Kingdom 01635 523545

Glossary

Prefix	Meaning	Value
p-	pico-	10^{-12}
n-	nano-	10^{-9}
μ -	micro-	10^{-6}
m-	milli-	10^{-3}
k-	kilo-	10^3
M-	mega-	10^6
G-	giga-	10^9
t-	tera-	10^{12}

Symbols

° degrees

Ω ohms

A

A amperes

A16 space VXIbus address space equivalent to the VME 64 KB *short* address space. In VXI, the upper 16 KB of A16 space is allocated for use by VXI devices' configuration registers. This 16 KB region is referred to as VXI configuration space.

A24 space VXIbus address space equivalent to the VME 16 MB *standard* address space.

A32 space VXIbus address space equivalent to the VME 4 GB *extended* address space.

address Character code that identifies a specific location (or series of locations) in memory. In VISA, it identifies a resource.

address modifier	One of six signals in the VMEbus specification used by VMEbus masters to indicate the address space in which a data transfer is to take place.
address space	A set of 2^n memory locations differentiated from other such sets in VXI/VMEbus systems by six addressing lines known as address modifiers. n is the number of address lines required to uniquely specify a byte location in a given space. Valid numbers for n are 16, 24, and 32. In VME/VXI, because there are six address modifiers, there are 64 possible address spaces.
ANSI	American National Standards Institute
API	Application Programming Interface—the direct interface that an end user sees when creating an application.
arbitration	A process in which a potential bus master gains control over a particular bus.
asynchronous	Not synchronized; not controlled by time signals. In IEEE 1394, specifically, this is the standard protocol for sending packets that require an acknowledgment. This guarantees data delivery. The NI-VXI/VISA drivers for 1394 use this protocol exclusively.
B	
b	Bit—one binary digit, either 0 or 1.
B	Byte—eight related bits of data, an 8-bit binary number. Also used to denote the amount of memory required to store one byte of data.
backplane	An assembly, typically a printed circuit board, with 96-pin connectors and signal paths that bus the connector pins. A C-size VXIbus system will have two sets of bused connectors called J1 and J2. A D-size VXIbus system will have three sets of bused connectors called J1, J2, and J3.
BERR*	bus error signal
BIOS	Basic Input/Output System. BIOS functions are the fundamental level of any PC or compatible computer. BIOS functions embody the basic operations needed for successful use of the computer's hardware resources.

block-mode transfer	An uninterrupted transfer of data elements in which the master sources only the first address at the beginning of the cycle. The slave is then responsible for incrementing the address on subsequent transfers so that the next element is transferred to or from the proper storage location. A VME data transfer may have no more than 256 elements.
bus	The group of conductors that interconnect individual circuitry in a computer. Typically, a bus is the expansion vehicle to which I/O or other devices are connected. Examples of buses include the ISA bus, PCI bus, VXI bus, and VME bus.
bus error	An error that signals failed access to an address. Bus errors occur with low-level accesses to memory and usually involve hardware with bus mapping capabilities. For example, nonexistent memory, a nonexistent register, or an incorrect device access can cause a bus error.
bus master	A device that is capable of requesting the Data Transfer Bus (DTB) for the purpose of accessing a slave device.
byte order	How bytes are arranged within a word or how words are arranged within a longword. Motorola ordering stores the most significant byte (MSB) or word first, followed by the least significant byte (LSB) or word. Intel ordering stores the LSB or word first, followed by the MSB or word.

C

C	Celsius
CLK10	A 10 MHz, ± 100 ppm, individually buffered (to each module slot), differential ECL system clock that is sourced from Slot 0 of a VXIbus mainframe and distributed to Slots 1 through 12 on P2. It is distributed to each slot as a single-source, single-destination signal with a matched delay of under 8 ns.
CMOS	Complementary Metal Oxide Semiconductor—a process used in making chips.

Commander	A message-based device that is also a bus master and can control one or more Servants.
configuration registers	A set of registers through which the system can identify a module device type, model, manufacturer, address space, and memory requirements. To support automatic system and memory configuration, the VXI specification requires that all VXIbus devices have a set of such registers.

D

Data Transfer Bus	DTB; one of four buses on the VMEbus backplane. The DTB is used by a bus master to transfer binary data between itself and a slave device.
DMA	Direct Memory Access—a method by which data is transferred between devices and internal memory without intervention of the central processing unit. DMA is the fastest method of transferring data to/from computer memory.
DRAM	Dynamic RAM (Random Access Memory)—storage that the computer must refresh at frequent intervals.
dynamic configuration	A method of automatically assigning logical addresses to VXIbus devices at system startup or other configuration times.
dynamically configured device	A device that has its logical address assigned by the Resource Manager. a VXI device initially responds at Logical Address 255 when its MODID line is asserted. The Resource Manager subsequently assigns it a new logical address, to which the device responds until powered down.

E

ECL	Emitter-Coupled Logic
EEPROM	Electrically Erasable Programmable Read Only Memory—ROM that can be erased with an electrical signal and reprogrammed.
embedded controller	An intelligent CPU (controller) interface plugged directly into the VXI backplane, giving it direct access to the VXIbus. It must have all of its required VXI interface capabilities built in.
EMC	electromagnetic compliance

EMI electromagnetic interference

external trigger A voltage pulse from an external source that triggers an event.

F

fair requester A VXIbus device that will not arbitrate for the VXIbus after releasing it until it detects the bus request signal inactive. This ensures that all requesting devices will be granted use of the bus.

FireWire An Apple trademark for the technology that came to be defined as IEEE 1394. *See* IEEE 1394.

G

g (1) grams
(2) a measure of acceleration equal to 9.8 m/s^2

GPIB General Purpose Interface Bus (IEEE 488)

g_{RMS} A measure of random vibration. The root mean square of acceleration levels in a random vibration test profile.

H

hex Hexadecimal—the numbering system with base 16, using the digits 0 to 9 and letters A to F.

hot plug-in capability The ability, a feature in IEEE 1394, to add and remove devices to a computer while the computer is running and have the operating system automatically recognize the change.

Hz hertz; cycles per second

I

IDE Integrated Drive Electronics. Denotes the most common interface to the hard drive on PCs.

IEC	International Electrotechnical Commission. The IEC publishes internationally recognized standards. IEC 60068 contains information on environmental testing procedures and severities.
IEEE	Institute of Electrical and Electronics Engineers
IEEE 1394	A cross-platform implementation of the high-speed serial data bus, defined by IEEE Standard 1394-1995, that can move large amounts of data between computers and peripheral devices. It features simplified cabling, hot swapping, and transfer speeds of up to 400 Mbits/s. IEEE 1394 also enables the connection of digital consumer products, including digital camcorders, digital video tapes, digital video disks, set-top boxes, and music systems, directly to a personal computer.
i.LINK	A brand name initiated by Sony for digital consumer products using IEEE 1394. <i>See</i> IEEE 1394.
in.	inches
I/O	Input/output—the techniques, media, and devices used to achieve communication between machines and users.
instrument driver	A set of routines designed to control a specific instrument or family of instruments, and any necessary related files for LabWindows/CVI or LabVIEW.
interrupt	A means for a device to request service from another device; a computer signal indicating that the CPU should suspend its current task to service a designated activity.
interrupt handler	A VMEbus functional module that detects interrupt requests generated by interrupters and responds to those requests by requesting status and identify information.
interrupt level	The relative priority at which a device can interrupt.
IRQ*	interrupt signal
isochronous	Pertains to processes that require timing coordination to be successful, such as voice and digital video transmission. A sound or picture going from a peripheral computer device or across a network into a computer or television set needs to arrive at close to the same rate of data flow as the source. In IEEE 1394, this protocol is used for purposes such as feeding digital image data from a peripheral device (such as a video camera) to a display mechanism within a computer.

K

K kilo—(1) the standard metric prefix for 1,000, or 10^3 , used with units of measure such as volts, hertz, and meters; (2) the prefix for 1,024, or 2^{10} , used with B (byte) in quantifying data or computer memory.

L

logical address An 8-bit number that uniquely identifies each VXIbus device in a system. It defines the A16 register address of a device, and indicates Commander and Servant relationships.

M

m meters

M mega—(1) the standard metric prefix for 1 million or 10^6 , when used with units of measure such as volts and hertz; (2) the prefix for 1,048,576, or 2^{20} , when used with B (byte) to quantify data or computer memory.

master A functional part of a VME/VXIbus device that initiates data transfers on the backplane. A transfer can be either a read or a write.

message-based device An intelligent device that implements the defined VXIbus registers and communication protocols. These devices are able to use Word Serial Protocol to communicate with one another through communication registers.

MODID Module ID lines—used in VXI to geographically locate boards and to dynamically configure boards.

MTBF Mean Time Between Failure

N

NI-488.2 or NI-488.2M The National Instruments industry-standard software for controlling GPIB instruments.

NI-DAQ The National Instruments industry-standard software for data acquisition instruments.

NI-VISA	The National Instruments implementation of the VISA standard; an interface-independent software that provides a unified programming interface for VXI, GPIB, and serial instruments.
NI-VXI	The National Instruments bus interface software for VME/VXIbus systems.
Non-Slot 0 device	A device configured for installation in any slot in a VXIbus mainframe other than Slot 0. Installing such a device into Slot 0 can damage the device, the VXIbus backplane, or both.

O

OHCI	Open Host Controller Interface. Specification for the register set for a 1394 controller card. This standard allows interoperability of software with controllers from different vendors.
------	---

P

PCI	Peripheral Component Interconnect. The PCI bus is a high-performance 32-bit or 64-bit bus with multiplexed address and data lines.
-----	--

R

register-based device	A Servant-only device that supports VXIbus configuration registers. Register-based devices are typically controlled by message-based devices via device-dependent register reads and writes.
Resman	The name of the National Instruments Resource Manager in NI-VXI bus interface software. <i>See</i> Resource Manager.
Resource Manager	A message-based Commander located at Logical Address 0, which provides configuration management services such as address map configuration, Commander and Servant mappings, and self-test and diagnostic management.
retry	An acknowledge by a destination that signifies that the cycle did not complete and should be repeated.
RMS	Root mean squared. <i>See</i> gRMS.

S

s	seconds
SIMM	Single In-line Memory Module
slave	A functional part of a VME/VXIbus device that detects data transfer cycles initiated by a VMEbus master and responds to the transfers when the address specifies one of the device's registers.
Slot 0 device	A device configured for installation in Slot 0 of a VXIbus mainframe. This device is unique in the VXIbus system in that it performs the VXI/VMEbus System Controller functions, including clock sourcing and arbitration for data transfers across the backplane. Installing such a device into any other slot can damage the device, the VXIbus backplane, or both.
SMB	Sub Miniature Type B connector that features a snap coupling for fast connection.
statically configured device	A device whose logical address cannot be set through software; that is, it is not dynamically configurable.
streaming data	Data that is structured and processed in a continuous flow, such as digital audio and video. In IEEE 1394, this is often sent with the isochronous protocol rather than the standard asynchronous protocol.
SYSFAIL	A VMEbus signal that is used by a device to indicate an internal failure. A failed device asserts this line. In VXI, a device that fails also clears its PASSEd bit in its Status register.

T

trigger	Either TTL or ECL lines used for intermodule communication.
TTL	Transistor-Transistor Logic

V

V	volts
VGA	Video Graphics Array; the minimum video display standard for all PCs.

VIC	VXI Interactive Control program, a part of the NI-VXI bus interface software. Used to program VXI devices and develop and debug VXI application programs.
VISA	Virtual Instrument Software Architecture. This is the general name given to VISA and its associated architecture.
VISAIC	VISA Interactive Control program, a part of the NI-VISA software. Used to program devices and develop and debug application programs.
VITA	VMEbus International Trade Association
VME	Versa Module Eurocard or IEEE 1014
VMEbus System Controller	A device configured for installation in Slot 0 or a VXIbus mainframe or the first slot in a VMEbus chassis. This device is unique in the VMEbus system in that it performs the VMEbus System Controller functions, including clock sourcing and arbitration for data transfers across the backplane. Installing such a device into any other slot can damage the device, the VMEbus/VXIbus backplane, or both.
VXIbus	VMEbus Extensions for Instrumentation

W

W	watts
Word Serial Protocol	The simplest required communication protocol supported by message-based devices in a VXIbus system. It utilizes the A16 communication registers to transfer data using a simple polling handshake method.
write posting	A mechanism that signifies that a device will immediately give a successful acknowledge to a write transfer and place the transfer in a local buffer. The device can then independently complete the write cycle to the destination.

Index

Numerics

1394 6-pin connectors, 1-4
1394 LED, 1-4

A

additional compiler information, 3-6
advanced hardware configuration settings, C-1
application development, 3-1
application software, 1-6

C

cable your system (caution), 2-6
capability codes
 VMEbus, A-3
capability descriptions
 IEEE 1394, A-3
CLK10
 routing, VXI bus, C-5
 signal accuracy, D-6
 signal type, D-5
CLK10 switches
 default settings (figure), C-6
 receive external with 50 ohm termination
 (figure), C-7
common questions, D-1
 1394 adapters and the VXI-1394 and
 VXI-1394/G, D-2
 Configuration EEPROM is Invalid message,
 D-5
 controlling the VXI chassis, D-2
 hot plug-in
 and IEEE 1394, D-1
 LEDs, definitions of, D-5
 NI-VXI utility programs, D-4

 PCI-GPIB and VXI-1394/G in the same
 computer, D-2
 PCI-MXI-2 and PCI-1394 interfaces in the
 same computer, D-2
 plugging in multiple peripherals, D-1
 Resman, D-3
 using, D-4
 serial number and hardware revision of
 VXI-1394, D-3
 shared memory and dual-ported memory,
 D-6
 VME devices, D-4
 VXI-1394 and 1394 host adapter, D-1
 VXI-1394 system expansion, D-2
configuration, 2-1
 advanced hardware settings, C-1
 advanced options, 1-4, C-1
 application development, 3-1
 default settings, B-1
 EEPROM, C-4
 hardware, 2-3
 setup, 2-1
 VXI-1394 default configuration settings
 (figure), C-2
 VXIbus slot configuration (figure), C-3
Configuration EEPROM is Invalid message, D-5
connectors, 1394 6-pin, 1-4

D

debugging, 3-9
default settings, B-1
 CLK10 switches, C-6
 hardware, 2-3, B-1
 software, B-2
developing applications, 3-1
device interaction, 3-2
device tab default settings (table), B-2

E

EEPROM

- configuration, C-4
 - Configuration EEPROM is Invalid message, D-5
 - operation (figure), C-4
- electrostatic discharge (caution), 2-4

F

- front panel
- LEDs, definitions of, D-5
- front panel features, 1-4

G

- getting started
- what you need, 1-2
- GPIB
- configuration utility, 1-5
 - front panel port, 1-3
- GPIB connector (VXI-1394/G version only), 1-4

H

- hardware
- advanced configuration settings, C-1
 - default settings, B-1, C-1
 - description, 1-3
 - installing, 2-4
 - PCI-1394, 1-3
- host adapter, D-2
- hot plug-in
- and IEEE 1394, D-1
 - definition of, 1-1

I

- IEEE 1394
- capability descriptions, A-3
- installation, 2-1

L

- LabVIEW
- definition of, 1-6
- LabWindows/CVI, 3-6
- definition of, 1-6
- LEDs
- 1394, 1-4
 - definitions of, D-5
 - SYSFAIL, 1-4
 - VXI, 1-4

M

- multiple devices
- connecting (note), (caution), 1-2

N

- National Instruments application software, 1-6
- LabVIEW, 1-6
 - LabWindows/CVI, 1-6
- National Instruments Web support, E-1
- NI Spy, 1-5, 3-9
- NI-488.2, 3-4
- installing, 2-2
 - troubleshooting wizard, 3-9
- NI-VISA, 3-4
- definition and functionality of, 1-4
 - installing, 2-2
- NI-VXI, 3-4
- building applications, 3-6
 - definition and functionality of, 1-4
 - installing, 2-2

NI-VXI and NI-VISA, programming
 examples, 3-5
 NI-VXI/VISA
 bus interface software, 1-1

O

OHCI host adapter, 1-1, 1-2
 online problem-solving and diagnostic
 resources, E-1
 overview
 VXI-1394 kit, 1-2

P

PCI-1394, 1-3
 host adapter, installing, 2-5
 interface board
 installing, 2-5
 programming
 additional compiler information, 3-6
 additional software notes, 3-7
 debugging, 3-9
 NI-VXI and NI-VISA examples, 3-5
 software compatibility, 3-7
 system configuration functions, 3-7
 VXI and GPIB, 3-4
 VXIbus access functions, 3-7

R

Resman, 1-5, 2-8
 power cycling (note), 3-1
 using, D-4
 resource manager
See Resman.
 restart system power, 2-7

S

setup, 2-1
 shared memory, 3-7
 shared memory tab default settings (table),
 B-2
 slot 0/non-slot 0, C-2
 slot configuration, VXI bus (figure), C-3
 software
 additional notes, 3-7
 compatibility, 3-7
 description, 1-4
 development
 reducing VXI/VME development
 time, 1-6
 installation, 2-1, 2-2
 installation (note), (caution), 2-2
 system configuration functions, 3-7
 VXIbus access functions, 3-7
 software-related resources, E-2
 specifications, A-1
 environmental, A-1
 physical, A-2
 power requirement, A-1, A-2
 requirements, A-1
 SYSFAIL LED, 1-4
 system controller, 2-6

T

T&M Explorer, 1-5, 2-3, 2-8, 3-6
 device interaction, 3-2
 device tab default settings (table), B-2
 shared memory tab default settings
 (table), B-2
 VXI bus tab default settings (table), B-3
 technical support resources, E-1
 telephone support, E-2
 troubleshooting wizard (NI-488.2), 3-9

U

user configurable settings, C-1

V

VISAIC and VIC, 3-2, 3-9

VME support, 3-8

VMEbus capability codes, A-3

VXI bus tab default settings (table), B-3

VXI LED, 1-4

VXI-1394

 default configuration settings (figure),
 C-2

 front panel features, 1-4

 hardware default settings (table), B-1

 interface board, installing, 2-6

 interface kit overview, 1-2

 module description, 1-3

 specifications, A-1

 system expansion, D-2

 typical system setup (figure), 2-4

VXI-1394/G

 and GPIB port, 1-5

 specifications, A-1

VXIbus

 CLK10 routing, C-5

 slot 0/non-slot 0, C-2

 slot configuration (figure), C-3

W

Web support from National Instruments

 online problem-solving and diagnostic
 resources, E-1

 software-related resources, E-2

Windows 98

 and IEEE 1394 host adapter drivers, 2-7

Windows NT

 drivers for, support (note), 1-1

worldwide technical support, E-2