

COMPREHENSIVE SERVICES

We offer competitive repair and calibration services, as well as easily accessible documentation and free downloadable resources.

SELL YOUR SURPLUS

We buy new, used, decommissioned, and surplus parts from every NI series. We work out the best solution to suit your individual needs.

 Sell For Cash  Get Credit  Receive a Trade-In Deal

OBSOLETE NI HARDWARE IN STOCK & READY TO SHIP

We stock **New**, **New Surplus**, **Refurbished**, and **Reconditioned** NI Hardware.



Bridging the gap between the manufacturer and your legacy test system.

 1-800-915-6216

 www.apexwaves.com

 sales@apexwaves.com

All trademarks, brands, and brand names are the property of their respective owners.

Request a Quote

 **CLICK HERE**

PCI-Step-20X

Motion Control

FlexMotion™ Software Reference Manual

Worldwide Technical Support and Product Information

www.natinst.com

National Instruments Corporate Headquarters

11500 North Mopac Expressway Austin, Texas 78759-3504 USA Tel: 512 794 0100

Worldwide Offices

Australia 03 9879 5166, Austria 0662 45 79 90 0, Belgium 02 757 00 20, Brazil 011 284 5011,
Canada (Calgary) 403 274 9391, Canada (Ontario) 905 785 0085, Canada (Québec) 514 694 8521,
China 0755 3904939, Denmark 45 76 26 00, Finland 09 725 725 11, France 01 48 14 24 24,
Germany 089 741 31 30, Greece 30 1 42 96 427, Hong Kong 2645 3186, India 91805275406,
Israel 03 6120092, Italy 02 413091, Japan 03 5472 2970, Korea 02 596 7456, Mexico (D.F.) 5 280 7625,
Mexico (Monterrey) 8 357 7695, Netherlands 0348 433466, Norway 32 27 73 00, Singapore 2265886,
Spain (Barcelona) 93 582 0251, Spain (Madrid) 91 640 0085, Sweden 08 587 895 00,
Switzerland 056 200 51 51, Taiwan 02 2377 1200, United Kingdom 01635 523545

For further support information, see the *Technical Support Resources* appendix. To comment on the documentation, send e-mail to techpubs@natinst.com.

© Copyright 1998, 1999 National Instruments Corporation. All rights reserved.

Important Information

Warranty

The media on which you receive National Instruments software are warranted not to fail to execute programming instructions, due to defects in materials and workmanship, for a period of 90 days from date of shipment, as evidenced by receipts or other documentation. National Instruments will, at its option, repair or replace software media that do not execute programming instructions if National Instruments receives notice of such defects during the warranty period. National Instruments does not warrant that the operation of the software shall be uninterrupted or error free.

A Return Material Authorization (RMA) number must be obtained from the factory and clearly marked on the outside of the package before any equipment will be accepted for warranty work. National Instruments will pay the shipping costs of returning to the owner parts which are covered by warranty.

National Instruments believes that the information in this document is accurate. The document has been carefully reviewed for technical accuracy. In the event that technical or typographical errors exist, National Instruments reserves the right to make changes to subsequent editions of this document without prior notice to holders of this edition. The reader should consult National Instruments if errors are suspected. In no event shall National Instruments be liable for any damages arising out of or related to this document or the information contained in it.

EXCEPT AS SPECIFIED HEREIN, NATIONAL INSTRUMENTS MAKES NO WARRANTIES, EXPRESS OR IMPLIED, AND SPECIFICALLY DISCLAIMS ANY WARRANTY OF MERCHANTABILITY OR FITNESS FOR A PARTICULAR PURPOSE. CUSTOMER'S RIGHT TO RECOVER DAMAGES CAUSED BY FAULT OR NEGLIGENCE ON THE PART OF NATIONAL INSTRUMENTS SHALL BE LIMITED TO THE AMOUNT THERETOFORE PAID BY THE CUSTOMER. NATIONAL INSTRUMENTS WILL NOT BE LIABLE FOR DAMAGES RESULTING FROM LOSS OF DATA, PROFITS, USE OF PRODUCTS, OR INCIDENTAL OR CONSEQUENTIAL DAMAGES, EVEN IF ADVISED OF THE POSSIBILITY THEREOF. This limitation of the liability of National Instruments will apply regardless of the form of action, whether in contract or tort, including negligence. Any action against National Instruments must be brought within one year after the cause of action accrues. National Instruments shall not be liable for any delay in performance due to causes beyond its reasonable control. The warranty provided herein does not cover damages, defects, malfunctions, or service failures caused by owner's failure to follow the National Instruments installation, operation, or maintenance instructions; owner's modification of the product; owner's abuse, misuse, or negligent acts; and power failure or surges, fire, flood, accident, actions of third parties, or other events outside reasonable control.

Copyright

Under the copyright laws, this publication may not be reproduced or transmitted in any form, electronic or mechanical, including photocopying, recording, storing in an information retrieval system, or translating, in whole or in part, without the prior written consent of National Instruments Corporation.

Trademarks

BridgeVIEW™, CVI™, FlexMotion™, LabVIEW™, natinst.com™, National Instruments™, and RTSI™ are trademarks of National Instruments Corporation.

Product and company names mentioned herein are trademarks or trade names of their respective companies.

WARNING REGARDING MEDICAL AND CLINICAL USE OF NATIONAL INSTRUMENTS PRODUCTS

National Instruments products are not designed with components and testing for a level of reliability suitable for use in or in connection with surgical implants or as critical components in any life support systems whose failure to perform can reasonably be expected to cause significant injury to a human. Applications of National Instruments products involving medical or clinical treatment can create a potential for death or bodily injury caused by product failure, or by errors on the part of the user or application designer. Because each end-user system is customized and differs from National Instruments testing platforms and because a user or application designer may use National Instruments products in combination with other products in a manner not evaluated or contemplated by National Instruments, the user or application designer is ultimately responsible for verifying and validating the suitability of National Instruments products whenever National Instruments products are incorporated in a system or application, including, without limitation, the appropriate design, process and safety level of such system or application.

Contents

About This Manual

Conventions Used in This Manual.....	xv
Related Documentation.....	xvi

Chapter 1

Introduction

About the FlexMotion Software	1-1
What You Need to Get Started	1-2
Installing a FlexMotion Controller	1-2
Software Programming Choices	1-2
National Instruments Application Software	1-2
FlexMotion Language Support	1-3

Chapter 2

Building Applications with the FlexMotion Software Library

The FlexMotion Windows Libraries.....	2-1
Creating a 32-Bit Windows Application	2-2
Creating a 32-Bit LabWindows/CVI Application.....	2-2
Creating a 32-Bit Microsoft or Borland C/C++ Application	2-2
Creating a 32-Bit Visual Basic Application	2-3

Chapter 3

Programming Language Considerations

Variable Data Types	3-1
Primary Types	3-2
Arrays	3-2
Structures and Other User-Defined Data Types.....	3-3
Function Return Status.....	3-3
Board Identification Parameter	3-4
Language-Specific Considerations	3-4
C/C++ for Windows	3-4
Data Returned by Reference	3-4
Data Returned in Arrays	3-5
FlexMotion Data Structures	3-5
Visual Basic for Windows.....	3-6
u8 Data Type Not Supported	3-6
Data Returned by Reference	3-7

Data Returned in Arrays	3-7
User-Defined Data Types	3-8
Considerations when Using Read Functions	3-9
Example	3-9
Considerations when Using Functions with Input Vectors	3-10

Chapter 4 Software Overview

API Functional Organization	4-1
Axes, Vector Spaces, and Motion Resources	4-2
Resource IDs	4-2
Axes	4-2
Motion Resources	4-4
Encoders	4-4
ADC Channels	4-5
DAC Outputs	4-6
Stepper Outputs	4-7
General-Purpose I/O Ports	4-8
Vector Spaces	4-8
Function Types and Parameters	4-10
Bitmapped versus Per-Resource Functions	4-10
Single and Double-Buffered Parameters	4-10
Input and Return Vectors	4-11
Onboard Variables	4-12
Initialization Overview	4-12
Recommended Initialization Procedure	4-13
System Configuration	4-13
Motion I/O Configuration	4-13
Per-Axis Configuration	4-13
Initialize Trajectory Parameters (Per-Axis)	4-13
Establish a Position Reference (Per-Axis)	4-13
Motion Trajectories	4-14
Trajectory Types and Modes	4-14
Trapezoidal Point-to-Point Position Control	4-14
Velocity Control	4-15
Move Blending	4-15
Electronic Gearing	4-16
Linear and Circular Interpolation	4-16
Pull-in Moves	4-17
Trajectory Parameters	4-17
Velocity in RPM	4-18
Velocity in Counts/s or Steps/s	4-18
Acceleration in RPS/s	4-19

Velocity Override in Percent.....	4-19
Arc Angles in Degrees	4-19
Communication between the Host Computer and the FlexMotion Controller	4-20
Board ID	4-20
Packets, Handshaking, and FIFO Buffers	4-21
Return Data Buffer	4-21
Errors and Error Handling	4-22
Modal and Non-Modal Errors	4-22
Error Message Stack	4-23
Communicate versus Individual Function Entry Points	4-23
Onboard Programs	4-24
Fatal Hardware and Communication Errors.....	4-24
Error Handling Techniques	4-24

Chapter 5

Axis & Resource Configuration Functions

flex_config_axis.....	5-2
flex_config_mc_criteria.....	5-6
flex_config_step_mode_pol.....	5-9
flex_config_vect_spc	5-11
flex_enable_axes.....	5-13
flex_load_counts_steps_rev.....	5-17
flex_load_pid_parameters.....	5-19
flex_load_single_pid_parameter.....	5-21
flex_load_vel_tc_rs.....	5-28
flex_set_stepper_loop_mode	5-30

Chapter 6

Trajectory Control Functions

flex_check_blend_complete_status	6-2
flex_check_move_complete_status	6-4
flex_load_acceleration	6-6
flex_load_follow_err	6-8
flex_load_rpm.....	6-10
flex_load_rpsps.....	6-12
flex_load_target_pos.....	6-14
flex_load_velocity	6-16
flex_load_vs_pos	6-18
flex_read_axis_status and flex_read_axis_status_rtn	6-20
flex_read_blend_status and flex_read_blend_status_rtn	6-24

flex_read_follow_err and	
flex_read_follow_err_rtn.....	6-27
flex_read_mcs_rtn.....	6-29
flex_read_pos and	
flex_read_pos_rtn.....	6-31
flex_read_rpm and	
flex_read_rpm_rtn.....	6-33
flex_read_trajectory_status and	
flex_read_trajectory_status_rtn.....	6-35
flex_read_velocity and	
flex_read_velocity_rtn.....	6-39
flex_read_vs_pos and	
flex_read_vs_pos_rtn.....	6-41
flex_reset_pos.....	6-43
flex_set_op_mode.....	6-45
flex_wait_for_blend_complete.....	6-49
flex_wait_for_move_complete.....	6-52
Arcs Functions.....	6-55
flex_load_circular_arc.....	6-56
flex_load_helical_arc.....	6-58
flex_load_spherical_arc.....	6-60
Gearing Functions.....	6-63
flex_config_gear_master.....	6-64
flex_enable_gearing.....	6-66
flex_enable_gearing_single_axis.....	6-68
flex_load_gear_ratio.....	6-70
Advanced Trajectory Functions.....	6-72
flex_acquire_trajectory_data.....	6-73
flex_load_base_vel.....	6-75
flex_load_blend_fact.....	6-76
flex_load_pos_modulus.....	6-79
flex_load_rpm_thresh.....	6-80
flex_load_scurve_time.....	6-82
flex_load_torque_lim.....	6-84
flex_load_torque_offset.....	6-87
flex_load_vel_threshold.....	6-89
flex_load_velocity_override.....	6-91
flex_read_dac and	
flex_read_dac_rtn.....	6-93
flex_read_dac_limit_status and	
flex_read_dac_limit_status_rtn.....	6-95
flex_read_steps_gen and	
flex_read_steps_gen_rtn.....	6-97

flex_read_target_pos and flex_read_target_pos_rtn	6-99
flex_read_trajectory_data and flex_read_trajectory_data_rtn	6-101

Chapter 7

Start & Stop Motion Functions

flex_blend	7-2
flex_start	7-5
flex_stop_motion	7-8

Chapter 8

Motion I/O Functions

flex_configure_inhibits	8-2
flex_enable_home_inputs	8-4
flex_enable_limits	8-6
flex_load_sw_lim_pos	8-9
flex_read_home_input_status and flex_read_home_input_status_rtn	8-11
flex_read_limit_status and flex_read_limit_status_rtn	8-13
flex_set_home_polarity	8-15
flex_set_inhibit_momo	8-17
flex_set_limit_polarity	8-19
Breakpoint Functions	8-21
flex_enable_bp	8-22
flex_load_bp_modulus	8-25
flex_load_pos_bp	8-27
flex_read_breakpoint_status and flex_read_breakpoint_status_rtn	8-29
flex_set_bp_momo	8-31
High-Speed Capture Functions	8-33
flex_enable_hs_caps	8-34
flex_read_cap_pos and flex_read_cap_pos_rtn	8-36
flex_read_hs_cap_status and flex_read_hs_cap_status_rtn	8-38
flex_set_hs_cap_pol	8-41

Chapter 9 Find Home & Index Functions

flex_find_home.....	9-2
flex_find_index.....	9-7

Chapter 10 Analog & Digital I/O Functions

flex_configure_encoder_filter	10-2
flex_configure_pwm_output	10-4
flex_enable_adcs	10-7
flex_enable_encoders	10-9
flex_load_dac	10-11
flex_load_pwm_duty.....	10-12
flex_read_adc and	
flex_read_adc_rtn	10-13
flex_read_encoder and	
flex_read_encoder_rtn	10-15
flex_read_port and	
flex_read_port_rtn	10-17
flex_reset_encoder.....	10-19
flex_select_signal	10-20
flex_set_adc_range	10-23
flex_set_port_direction.....	10-25
flex_set_port_momo.....	10-27
flex_set_port_pol.....	10-30

Chapter 11 Error & Utility Functions

flex_get_error_description	11-2
flex_get_motion_board_info	11-6
flex_get_motion_board_name.....	11-9
flex_read_err_msg_rtn	11-11

Chapter 12 Onboard Programming Functions

flex_begin_store	12-2
flex_end_store	12-4
flex_insert_program_label.....	12-5
flex_jump_label_on_condition.....	12-6
flex_load_delay	12-11

flex_pause_prog.....	12-12
flex_read_program_status.....	12-13
flex_run_prog.....	12-15
flex_set_status_momo	12-16
flex_stop_prog	12-18
flex_wait_on_condition	12-19
Object Management Functions	12-24
flex_load_description	12-25
flex_object_mem_manage.....	12-26
flex_read_description_rtn.....	12-28
flex_read_registry_rtn	12-29
Data Operations Functions.....	12-31
flex_add_vars	12-32
flex_and_vars	12-33
flex_div_vars	12-34
flex_load_var.....	12-35
flex_lshift_var.....	12-36
flex_mult_vars.....	12-38
flex_not_var.....	12-39
flex_or_vars.....	12-40
flex_read_var and	
flex_read_var_rtn.....	12-41
flex_sub_vars.....	12-43
flex_xor_vars.....	12-44

Chapter 13

Advanced Functions

flex_clear_pu_status	13-2
flex_communicate.....	13-4
flex_enable_1394_watchdog	13-7
flex_enable_auto_start	13-8
flex_enable_shutdown	13-9
flex_flush_rdb.....	13-11
flex_read_csr_rtn	13-12
flex_reset_defaults	13-14
flex_save_defaults	13-15
flex_set_irq_mask	13-16

Appendix A

Error Codes

Appendix B FlexMotion Functions

Appendix C Default Parameters

Appendix D Onboard Variables, Input, and Return Vectors

Appendix E Technical Support Resources

Glossary

Index

Figures

Figure 4-1.	Servo Axis Resources	4-3
Figure 4-2.	Stepper Axis Resources	4-3
Figure 4-3.	ADC Input Resources	4-5
Figure 4-4.	DAC Output Resources.....	4-6
Figure 4-5.	3D Vector Space Resources.....	4-9
Figure 4-6.	Trapezoidal Trajectory with S-Curve Acceleration	4-15
Figure 5-1.	3-D Vector Space Example.....	5-12
Figure 6-1.	CircularArc Definitions	6-57
Figure 6-2.	Helical Arc Definitions	6-59
Figure 6-3.	Spherical Arc Pitch and Yaw Definitions	6-62
Figure 6-4.	Blending with Blend Factor of -1	6-77
Figure 6-5.	Blending with Blend Factor of 0.....	6-77
Figure 6-6.	Blending with Blend Factor of 50 ms.....	6-78
Figure 6-7.	Effects of S-Curve Acceleration on a Trapezoidal Trajectory.....	6-83
Figure 6-8.	Primary and Secondary Torque Limits Example.....	6-86
Figure 6-9.	Torque Offset Example.....	6-88
Figure 9-1.	Find Home Definitions	9-4
Figure 9-2.	Find Home Sequence Example.....	9-6

Tables

Table 3-1.	Primary Type Names	3-2
Table 4-1.	Axis Resource IDs	4-4
Table 4-2.	Encoder Resource IDs	4-5
Table 4-3.	ADC Resource IDs	4-6
Table 4-4.	DAC Resource IDs	4-7
Table 4-5.	Stepper Output Resource IDs	4-7
Table 4-6.	I/O Port Resource IDs	4-8
Table 4-7.	Vector Space Control Resource IDs	4-9
Table 10-1.	PWM Clock Frequency Settings	10-5
Table A-1.	Error Codes Summary	A-2
Table B-1.	FlexMotion Function Summary	B-1
Table B-2.	ValueMotion to FlexMotion Cross Reference	B-7
Table C-1.	Default Parameters	C-1
Table D-1.	Functions with More than One Data Parameter	D-1

About This Manual

The *FlexMotion Software Reference Manual* describes the FlexMotion software. The FlexMotion software is a powerful application programming interface (API) between your motion control application and the National Instruments FlexMotion controllers for ISA and PCI bus computers.

Conventions Used in This Manual



The following conventions are used in this manual:

This icon denotes a note, which alerts you to important information.



This icon denotes a caution, which advises you of precautions to take to avoid injury, data loss, or a system crash.



This icon denotes a warning, which advises you of precautions to take to avoid being electrically shocked.

7344 controllers

Refers to the PCI-7344, PXI-7344, and FW-7344. These controllers have four axes.

bold

Bold text denotes parameter names.

italic

Italic text denotes variables, emphasis, a cross reference, or an introduction to a key concept. This font also denotes text that is a placeholder for a word or value that you must supply.

monospace

Text in this font denotes text or characters that you should enter from the keyboard, sections of code, programming examples, and syntax examples. This font is also used for the proper names of directories, functions, variables, filenames and extensions, and code excerpts.

FlexMotion-6C
controllers

Refers to the PC-FlexMotion-6C and the PCI-FlexMotion-6C. These controllers have six axes.

FlexMotion software
reference

Unless otherwise noted, this phrase refers to both the *FlexMotion Software Reference Manual* and the *FlexMotion Software Reference Online Help*.

Related Documentation

The following documents contain information that you might find helpful as you read this manual:

- Your motion controller user manual
- *FlexMotion Software Reference Online Help*

Introduction

This chapter gives an overview of the FlexMotion software, lists what you need to get started, and where to find information on installing your hardware.

About the FlexMotion Software

FlexMotion software provides a comprehensive API you use to control the FlexMotion controllers. FlexMotion software combined with the FlexMotion controllers provide functionality and power for integrated motion systems for use in laboratory, test, and production environments.

For programming ease, FlexMotion software is enhanced by a toolbox of drivers, C Function Libraries, and Windows dynamic link libraries (DLLs) that implement the entire FlexMotion API.

The FlexMotion software package includes Measurement & Automation Explorer, which associates physical bus addresses with board IDs, which are used in programs to distinguish between controllers. Measurement & Automation Explorer also verifies that the FlexMotion controller is installed correctly and is communicating with the host computer.

FlexMotion software also includes a Windows-compatible motion application, FlexCommander, which provides access to the FlexMotion application programming interface (API) in an easy-to-use, scriptable environment. Simply pointing to and clicking on the desired function allows you to interactively set up and control system parameters and all multi-axis motion commands.

For application development, the FlexMotion software package includes example programs to help get you up and running quickly.

A separate FlexMotion virtual instrument (VI) package includes a complete motion VI library, with examples, for use with LabVIEW.

What You Need to Get Started

To set up and use your FlexMotion software, you need the following:

- FlexMotion software
- FlexMotion hardware
- FlexMotion Software Reference Manual*

Installing a FlexMotion Controller

Use Measurement & Automation Explorer to configure and verify your FlexMotion controllers. Refer to the FlexMotion release notes and the Explore Motion Control online help for detailed information regarding FlexMotion controller installation and configuration. In addition, refer to your motion controller user manual for information about I/O jumper settings and bus address DIP switches (for ISA boards).

Software Programming Choices

You have several options to choose from when programming with your National Instruments FlexMotion software. You can use National Instruments application software such as LabVIEW, BridgeVIEW—LabVIEW for Industrial Automation, or LabWindows/CVI, or third-party application development environments (ADEs) such as Borland C/C++, Microsoft Visual C/C++, Microsoft Visual Basic, or any other Windows-based compiler that can call into Windows DLLs for use with the FlexMotion software.

National Instruments Application Software

LabVIEW and BridgeVIEW feature interactive graphics, a state-of-the-art user interface, and a powerful graphical programming language. The FlexMotion VI Library, a set of VIs for using LabVIEW with National Instruments FlexMotion hardware, is available separately.

LabWindows/CVI features interactive graphics, a state-of-the-art user interface, and uses the ANSI standard C programming language. The functions that comprise the FlexMotion software library can be called from LabWindows/CVI.

Using LabVIEW, BridgeVIEW, or LabWindows/CVI software will greatly reduce the development time for your motion control application.

FlexMotion Language Support

The FlexMotion software library is a DLL in Windows 2000/NT/98/95. You can use the Windows DLL with any Windows development environment that can call Windows DLLs. Chapter 2, *Building Applications with the FlexMotion Software Library*, provides more specific information on building Windows applications with Microsoft Visual C/C++, Microsoft Visual Basic, and Borland C/C++.

Building Applications with the FlexMotion Software Library

This chapter describes the fundamentals of creating FlexMotion applications under Windows 2000/NT/98/95.

The FlexMotion Windows Libraries

This section contains general information about building FlexMotion applications, describes the nature of the FlexMotion files used in building FlexMotion applications, and explains the basics of building applications using the following tools:

- LabWindows/CVI
- Borland C/C++
- Microsoft Visual C/C++
- Microsoft Visual Basic

If you are not using one of the tools listed, consult your development tool reference manual for details on creating applications that call DLLs.

The FlexMotion DLL, `FlexMotion32.dll`, is used by FlexMotion applications under all versions of Windows.

If you are programming in C or C++, you must link in the appropriate import library so that you can call the FlexMotion DLL. In Windows 2000/NT/98/95, the import libraries are different for Microsoft and Borland C/C++. The import libraries contain information about the FlexMotion DLL-exported functions.

FlexMotion is packaged with function prototype files for different Windows development tools. For C/C++ development, the FlexMotion header file, `flexmotn.h`, is provided. For Visual Basic development, a BAS module, `flexmotn.bas`, is provided. If you are not using any of these development tools, you may need to create your own function prototype file based on the files provided with the FlexMotion software.

Creating a 32-Bit Windows Application

Under Windows 2000/NT/98/95, FlexMotion applications should call the `FlexMotion32.dll`. The FlexMotion DLL is installed in the `Windows\System` directory in Windows 98/95 and in the `Winnt\System32` directory in Windows 2000/NT.

Creating a 32-Bit LabWindows/CVI Application

The FlexMotion header file for LabWindows/CVI programmers is `FlexMotn.h`. `FlexMotn.h` automatically includes other required files such as `motnerr.h` (the FlexMotion error file, for errors returned by the FlexMotion functions), and `motncnst.h` (the FlexMotion constants file, for the constants used while making calls to the FlexMotion functions). All header files are installed in the `FlexMotion\Include` directory.

To create an application using LabWindows/CVI, link to the appropriate FlexMotion import library. If you set the default compiler compatibility mode to Microsoft Visual C++, link to `FlexMS32.lib` (installed in the `FlexMotion\lib\Microsoft` directory). If you set the default compiler compatibility mode to Borland C++, link to `FlexBC32.lib` library (installed in the `FlexMotion\lib\Borland` directory).

Example programs using these import libraries and the `Flexmotion32.dll` are installed in the `FlexMotion\Examples` directory.

Creating a 32-Bit Microsoft or Borland C/C++ Application

The FlexMotion header file for C/C++ programmers is `FlexMotn.h`. `FlexMotn.h` automatically includes other required files such as `motnerr.h` (the FlexMotion error file, for errors returned by the FlexMotion functions), and `motncnst.h` (the FlexMotion constants file, for the constants used while making calls to the FlexMotion functions). All header files are installed in the `FlexMotion\Include` directory.

Microsoft C/C++ programmers should link to the `FlexMS32.lib` import library (installed in the `FlexMotion\lib\Microsoft` directory). Borland C/C++ programmers should link to the `FlexBC32.lib` import library (installed in the `FlexMotion\lib\Borland` directory). The Borland import library is created in version 5.0.

C\C++ example programs using these import libraries and the `Flexmotion32.dll` are installed in the `FlexMotion\Examples` directory.

Creating a 32-Bit Visual Basic Application

The FlexMotion function prototype file for Visual Basic programmers is the `FlexMotn.bas` module. In addition, `Motnerr.bas` (the FlexMotion error file, for errors returned by the FlexMotion functions) and `Motncnst.bas` (the FlexMotion constants file, for the constants used while making calls to the FlexMotion functions) should also be included in Visual Basic projects when making FlexMotion applications. All the Visual Basic modules are installed into the `FlexMotion\Include` directory.

Visual Basic example programs are installed in the `FlexMotion\Examples` directory.

Programming Language Considerations

This chapter contains detailed information on programming language syntax and special considerations that you need to know before you develop your FlexMotion application.

In addition to LabVIEW, BridgeVIEW, and LabWindows/CVI, the FlexMotion software supports the following industry-standard programming environments:

- Microsoft Visual C/C++
- Borland C/C++
- Microsoft Visual Basic
- Any programming environment that can call into DLLs

This chapter includes information specific to each language environment as well as general syntax information that applies to all languages.

Variable Data Types

Every function description has a parameter table that lists the data types for each parameter. The following sections describe the notation used in those parameter tables and throughout the manual for variable data types.

Primary Types

Table 3-1 shows the primary type names and their ranges.

Table 3-1. Primary Type Names

Type Name	Description	Range	Type		
			C/C++	Visual BASIC	Pascal (Borland Delphi)
u8	8-bit ASCII character	0 to 255	Char	Not supported by BASIC. For functions that require character arrays, use string types instead.	Byte
i16	16-bit signed integer	-32,768 to 32,767	Short	Integer (for example, deviceNum%)	SmallInt
u16	16-bit unsigned integer	0 to 65,535	Unsigned short for 32-bit compilers	Not supported by BASIC. For functions that require unsigned integers, use the signed integer type instead. See the i16 description.	Word
i32	32-bit signed integer	-2,147,483,648 to 2,147,483,647	Long	Long (for example, count&)	LongInt
u32	32-bit unsigned integer	0 to 4,294,967,295	Unsigned long	Not supported by BASIC. For functions that require unsigned long integers, use the signed long integer type instead. See the i32 description.	Cardinal (in 32-bit operating systems). Refer to the i32 description.
f32	32-bit single-precision floating point	-3.402823×10^{38} to 3.402823×10^{38}	Float	Single (for example, num!)	Single
f64	64-bit double-precision floating point	$-1.797683134862315 \times 10^{308}$ to $1.797683134862315 \times 10^{308}$	Double	Double (for example, voltage Number)	Double

Arrays

When a primary type is inside square brackets, such as, [i16], an array of the type named is required for that parameter. Typically arrays are passed by reference, not value. For information about passing and returning arrays of data, refer to the *Language-Specific Considerations* section of this chapter.

Structures and Other User-Defined Data Types

FlexMotion software uses data structures to send and receive groups of parameters to and from the controller. Typically data structures are passed by reference not value. For information about passing and returning structures of data, refer to the [Language-Specific Considerations](#) section of this chapter.

Function Return Status

Every FlexMotion function is of the following form:

```
status = function_name (parameter 1, parameter 2, ...  
parameter n)
```

Each function returns a value in the status variable that indicates the success or failure of the function. A returned status of NIMC_noError (0) indicates that the function was sent to the FlexMotion controller successfully. A non-zero status indicates that the function was not executed because of an error. Refer to Appendix A, [Error Codes](#), for a complete description of errors and possible causes.

In addition to errors returned in the status variable, modal errors can occur when the controller executes the function. These modal errors have to be explicitly read from the Error Stack on the FlexMotion controller. Refer to the [Errors and Error Handling](#) section of Chapter 4, [Software Overview](#), for more information on modal errors and the Error Stack.

For C/C++ users, the header file, `flexmotn.h` provides the FlexMotion function prototypes. All the functions in `flexmotn.h` have FLEXFUNC as the return status. FLEXFUNC defines the return data type status. Under Windows, FLEXFUNC also defines the calling convention of the FlexMotion dynamic link library.

FLEXFUNC defines the return status of the FlexMotion functions to be `i32`. In addition, FLEXFUNC defines the calling convention as standard (`__stdcall`), which is the same as that used to call Win32 API functions.

For Visual Basic users, `flexmotn.bas` provides the FlexMotion function prototypes. All FlexMotion functions in Visual Basic return an `i32`.

Board Identification Parameter

The first parameter to every FlexMotion function is the board identification parameter.

For C/C++ users, all functions in `flexmotn.h` have BOARD as the first parameter. BOARD is defined as boardID (u8)—the board identification number assigned by Measurement & Automation Explorer.

For Visual Basic users, all functions in `flexmotn.bas` have boardID (Integer) as the first parameter, which is the board identification number assigned by Measurement & Automation Explorer.

Ensure that you pass the correct board identification parameter depending upon the programming language you are using. To use multiple FlexMotion devices in one application, simply pass the appropriate board identification parameter to each function.

Language-Specific Considerations

Apart from the data type differences, there are a few language-dependent considerations you need to be aware of when you use the FlexMotion API. Refer to the following sections that apply to your programming language.



Note Be sure to include the FlexMotion function prototypes by including the appropriate FlexMotion header file in your source code. Refer to Chapter 2, *Building Applications with the FlexMotion Software Library*, for the header file appropriate to your operating system and programming environment.

C/C++ for Windows

Data Returned by Reference

The FlexMotion functions that return data do so in variables whose address is passed into the function.

Example

To read position on an axis, you have to pass the address of the variable position.

```
i32 status;
i32 position;
u8 boardID = 1;
u8 axis = 1;
status = flex_read_pos_rtn (boardID, axis, &position);
```

The data position for axis one is returned in the `position` variable.

Data Returned in Arrays

While passing an array to a FlexMotion function, you need to pass the address of the beginning of the array.

Example

You would pass `returnData` as your parameter where `returnData` is an array of size `MAX i32s`.

```
#define MAX 12
i32 status;
u8 boardID;
i32 returnData [MAX];

boardID = 1;
status = flex_read_trajectory_data_rtn(boardID,
returnData);
```

Trajectory data is returned in the `returnData` array and can be accessed by incrementing through the array.

FlexMotion Data Structures

Two data structures are used by the FlexMotion functions—The registry information data structure **REGISTRY**, and the PID parameters data structure **PID**.

The registry information data structure **REGISTRY** is used by the [Read Object Registry](#) function to get the information about the object registry on the FlexMotion controller. For more information on the object registry, refer to Chapter 12, [Onboard Programming Functions](#).

```
typedef struct {
    u16 device; // The object number
    u16 type; // The type of object
    u32 pstart; // The address where the object is stored
    u32 size; // Size of the object
} REGISTRY;
```

The PID parameters data structure **PID** is used by the [Load All PID Parameters](#) function to load the **PID** and **PIVFF** parameter for an axis. For more information on **PID** and **PIVFF** parameters, refer to Chapter 5, [Axis & Resource Configuration Functions](#).

```
typedef struct{
    u16 kp; //Proportional Gain
    u16 ki; //Integral Gain
    u16 ilim; //Integration Limit
    u16 kd; //Derivative Gain
    u16 td; //Derivative Sample Period
    u16 kv; //Velocity Gain
    u16 aff; //Acceleration Feedforward
    u16 vff; //Velocity Feedforward
} PID;
```

Example

While using the data structures, pass the address of the structure in the function.

```
i32 status;
u8 boardID=1;
u8 axis=1;
u8 inputVector=0xFF;
PID PIDValues;
PIDValues.kp = 100;
PIDValues.ki = 0;
PIDValues.ilim = 1000;
PIDValues.kd = 1000;
PIDValues.td = 2;
PIDValues.kv = 0;
PIDValues.aff = 0;
PIDValues.vff = 0;
status = flex_load_pid_parameters(boardID, axis,
&PIDValues, inputVector);
```

Visual Basic for Windows

u8 Data Type Not Supported

Because Visual Basic does not support the u8 data type, all the FlexMotion functions that take parameters that are of type u8 can be passed integers (%). The FlexMotion DLL ignores the upper byte of the integer passed.

For example, the *Enable Axes* function, which has the data type for **boardID** and **PIDrate** as `u8`, can be called as shown in the following example.

Example

```
Dim status as long
Dim boardID as integer
Dim PIDrate as integer
Dim axisMap as integer
boardID = 1 `The board identification number
PIDrate = NIMC_PID_RATE_250 `250 microsecond update rate
axisMap = &H1E `Enable axes 1 through 4
status = flex_enable_axes (boardID, 0, PIDrate, axisMap)
```

Data Returned by Reference

The FlexMotion functions that return data do so in variables passed into the function by reference.

Example

```
Dim status as long
Dim boardID as integer
Dim position as long
Dim axis as integer
boardID = 1
axis = 1
status = flex_read_pos_rtn (boardID, axis, position)
```

The position for axis one is returned in the `position` variable.

Data Returned in Arrays

While passing an array to a FlexMotion function in Visual Basic, you need to pass the first element of the array by reference.

Example

You would pass in `returnData&(0)` as your parameter, where `returnData(0 to MAX)` is an array of `MAX` longs.

```
Dim status as long
Dim boardID as integer
Const MAX = 12
Dim returnData (0 to MAX) as long
```

```
boardID = 1
status = flex_read_trajectory_data_rtn(boardID,
returnData&(0))
```

Trajectory data is returned in the `returnData` array and can be accessed by incrementing through the array.

User-Defined Data Types

Two user-defined data types are used by the FlexMotion functions under Visual Basic—the registry information data type **registryRecord**, and the PID parameters data type **PIDVals**.

The registry information data type **registryRecord** is used by the [Read Object Registry](#) function to get the information about the object registry on the FlexMotion controller. For more information on the object registry, refer to Chapter 12, [Onboard Programming Functions](#).

```
Type registryRecord
    device As Integer`The object number
    type As Integer`The type of object
    pStart As Long`The address where the object is stored
    size As Long`Size of the object
End Type
```

The PID parameters data type **PIDVals** is used by the [Load All PID Parameters](#) function to load the **PID** and **PIVFF** parameters for an axis. For more information on **PID** and **PIVFF** parameters, refer to Chapter 5, [Axis & Resource Configuration Functions](#).

```
Type PIDVals
    kp As Integer`Proportional Gain
    ki As Integer`Integral Gain
    ilim As Integer`Integration Limit
    kd As Integer`Derivative Gain
    td As Integer`Derivative Sample Period
    kv As Integer`Velocity Gain
    aff As Integer`Acceleration Feedforward
    vff As Integer`Velocity Feedforward
End Type
```

Example

While using user-defined data types, pass the data types by reference to the function.

```
Dim boardID as integer
Dim axis as integer
Dim pidvalues As PIDVals
Dim inputVector as integer

pidvalues.kp = 100
pidvalues.ki = 0
pidvalues.ilim = 1000
pidvalues.kd = 1000
pidvalues.td = 2
pidvalues.kv = 0
pidvalues.aff = 0
pidvalues.vff = 0

boardID =1
axis = 1
inputVector = &HFF
status = flex_load_loop_params(boardID, axis, pidvalues,
inputVector)
```

Considerations when Using Read Functions

Read functions return data from the FlexMotion controller. There are two types of *Read* functions. The first takes a return vector and returns the data to a general-purpose variable in onboard memory, or the Return Data Buffer (RDB). This type of function is typically used in conjunction with onboard programming. The second type returns the data by reference into a variable in your application. The functions that return data by reference have a suffix *_rtn*. This is the more commonly used type of function. For more information on return vectors, refer to the [Input and Return Vectors](#) section of Chapter 4, [Software Overview](#).

Example

The return vector version of the [Read Position](#) function has the following function prototype:

```
status = flex_read_pos (boardID, axis, returnVector)
```

When you use this function, the data retrieved by the controller is placed into the general-purpose variable indicated by the **returnVector** parameter.

If the `returnVector` is `0xFF` (for Visual Basic users—`&HFF`), the return data is placed in the Return Data Buffer (RDB) for later retrieval.

The `_rtn` version of *Read Position* function has the following function prototype:

```
status = flex_read_pos_rtn (boardID, axis, position)
```

where `boardID` and `axis` are inputs and `position` is an output. When you use this function, the FlexMotion software places the data retrieved from the controller into the `position` variable that you referenced when calling the function. For C/C++ users, `position` is a pointer to an `i32`. For Visual Basic users, `position` is of type `long` and the pass-by-reference behavior is made clear to the compiler by the function prototype in the `Flexmotn.bas` header file.

Considerations when Using Functions with Input Vectors

FlexMotion functions that take an input vector allow the data for the function to be loaded from different sources. The **inputVector** argument in a function tells the FlexMotion controller whether to take the function data from the host computer or from an onboard general-purpose variable. An input vector of `0xFF` (for Visual Basic users, `&HFF`) will tell the FlexMotion controller to get the data from the host computer, in other words, from the data parameters in the function call. For more information on input vectors, refer to the *Input and Return Vectors* section of Chapter 4, *Software Overview*.

Software Overview

This chapter provides an overview of the FlexMotion API and describes the types of functions you use to configure, initialize, control, and read back data and status from the FlexMotion controller.

This chapter also includes discussions on advanced features and programming techniques that describe the power and flexibility of the FlexMotion architecture.

API Functional Organization

The FlexMotion API consists of over 120 functions organized into nine functional groups:

- Axis & Resource Configuration
- Trajectory Control (includes Arc, Gearing, and Advanced Trajectory functions)
- Start & Stop Motion
- Motion I/O (includes Breakpoint and High-Speed Capture functions)
- Find Home & Index
- Analog & Digital I/O
- Error & Utility
- Onboard Programming (includes Object Management and Data Operations functions)
- Advanced

Each group contains functions that are closely related to each other and some groups are further organized into advanced function subgroups. This hierarchical organization makes the extensive FlexMotion API easy to understand and use.

Detailed descriptions for the functions in each group are in chapters 5 through 13, respectively. Within each chapter and subsection, the functions are arranged alphabetically by function name. Each chapter and subsection begins with an overview that describes features and issues relating to all the functions in the section.

As a quick reference, a summary of the entire FlexMotion API is in Appendix B, *FlexMotion Functions*.

Axes, Vector Spaces, and Motion Resources

FlexMotion can control up to six axes of motion. The axes can be completely independent, simultaneously coordinated, or mapped in multidimensional groups called vector spaces. Axes themselves consist of software and hardware blocks, generically referred to as motion resources. FlexMotion allows hardware resources that are not mapped to axes to be used independently as general-purpose I/O.

Resource IDs

Many FlexMotion functions require an axis number or other resource ID to specify the target of the function. You can send these functions to axes, vector spaces, or to the motion resources directly. Other functions are dedicated or controller level and do not require a resource ID. Valid resource choices are listed in each function description in chapters 5 through 13.



Note By convention, resource IDs are given as hex values with the 0x prefix.

Axes

An axis consists of a trajectory generator, PID or stepper control block, and some sort of output resource, either a digital-to-analog converter (DAC) output or a stepper pulse generator output. Servo axes must also have some sort of feedback resource, either an encoder or ADC channel; refer to Figures 4-1 and 4-2. Closed-loop stepper axes also require a feedback resource, and can use either encoder or ADC inputs; open-loop stepper axes do not require feedback for correct operation.

With FlexMotion, you configure an axis with the *Configure Axis Resources* function by mapping feedback resources and output resources to the axis. An axis with its primary output resource a DAC, is by definition, a servo axis. An axis with its primary output resource a stepper output, is by definition, a stepper axis.

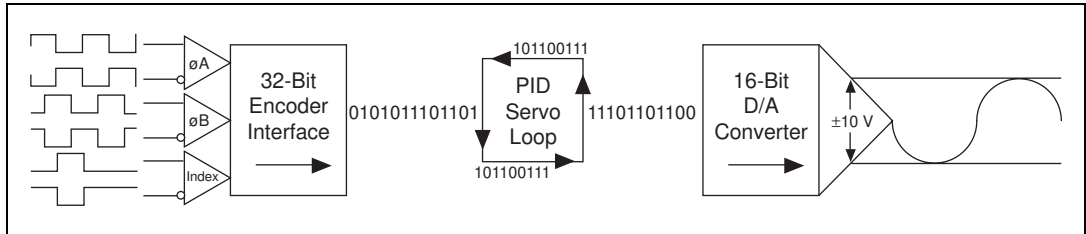

Figure 4-1. Servo Axis Resources

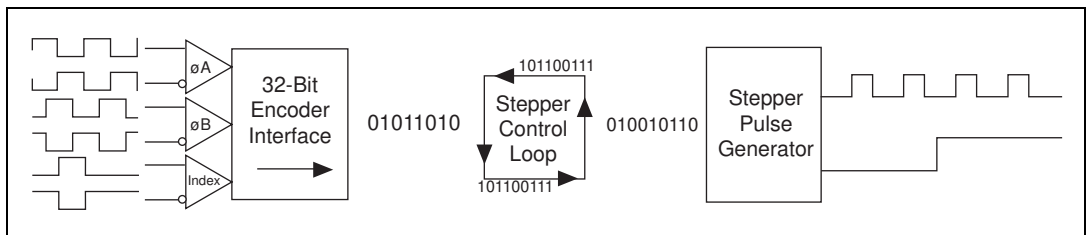

Figure 4-2. Stepper Axis Resources

In its default configuration, FlexMotion-6C controllers come preconfigured as six servo axes with Encoder 1 and DAC 1 mapped to Axis 1, Encoder 2 and DAC 2 mapped to Axis 2, and so on through Axis 6. The 7344 controllers are preconfigured as four servo axes with similar feedback and output resource mappings. However, you can map any feedback and output resource to any axis. This flexibility allows you to tailor each axis to accommodate your specific motion system requirements.



Note For many servo applications, the factory-default mapping of encoders and DACs to axes will meet your typical system requirement.

In addition to the primary feedback and output resources, axes can have secondary feedback and output resources mapped to them. You can use this capability to implement dual-loop feedback and other advanced control algorithms. Refer to the [Configure Axis Resources](#) function for more information.

Axes also have dedicated motion I/O assigned to them. A forward and reverse limit input, a home input, and an inhibit output are dedicated to each axis. Depending on whether you are using a FlexMotion-6C or 7344 controller, there are either six or four identical sets of these signals,

so mapping is not required. If not needed by the axis, you can also use the signals as general-purpose I/O. Table 4-1 lists the resource IDs for axes.

Table 4-1. Axis Resource IDs

Resource Name	Resource ID
Axis Control	0 (0x00)
Axis 1	1 (0x01)
Axis 2	2 (0x02)
Axis 3	3 (0x03)
Axis 4	4 (0x04)
Axis 5 (FlexMotion-6C only)	5 (0x05)
Axis 6 (FlexMotion-6C only)	6 (0x06)

Functions that can operate on multiple axes simultaneously (for example, *Read Blend Status* and *Start Motion*) can take the axis control (0) as their resource parameter.

Motion Resources

There are four types of motion resources on the FlexMotion controller: encoders, ADC channels, DAC outputs, and stepper outputs. In general, functions relating to motion resources (for example, *Read DAC* and *Read Steps Generated*) can be sent to the resource itself or the axis the resource is mapped to.



Note Once mapped to an axis, all features and functions of a motion resource are available as part of the axis. It is not necessary to remember or use the resource number directly when accessing these features as part of the axis. Resources are referenced by axis number once assigned to that axis.

Encoders

Encoder resources are primarily used for position feedback on servo and closed-loop stepper axes. When encoder resources are not mapped to an axis for use as axis feedback, you can use them for any number of other functions including position or velocity monitoring, as *digital*

potentiometer encoder inputs, or as master encoders for master/slave and gearing applications. Table 4-2 lists the resource IDs for encoders.

Table 4-2. Encoder Resource IDs

Resource Name	Resource ID
Encoder Control	0x20
Encoder 1	0x21
Encoder 2	0x22
Encoder 3	0x23
Encoder 4	0x24
Encoder 5 (FlexMotion-6C only)	0x25
Encoder 6 (FlexMotion-6C only)	0x26

Functions that can operate on multiple encoders simultaneously (for example, *Read High-Speed Capture Status*) can take the encoder control (0x20) as their resource parameter.

Encoders 1 through 4 (0x21 through 0x24) feature high-speed capture inputs and breakpoint outputs. These features are implemented in the encoder processor FPGA and are fully functional when an encoder is used as an independent resource or as feedback for an axis.

On FlexMotion-6C controllers, encoders 5 and 6 do not have these advanced features. Also, there are other performance differences between encoder input channels. Refer to Appendix A, *Specifications*, of your motion controller user manual for detailed encoder specifications.

ADC Channels

You can use ADC channels as analog feedback for axes or as general-purpose analog inputs to measure sensors or potentiometers.

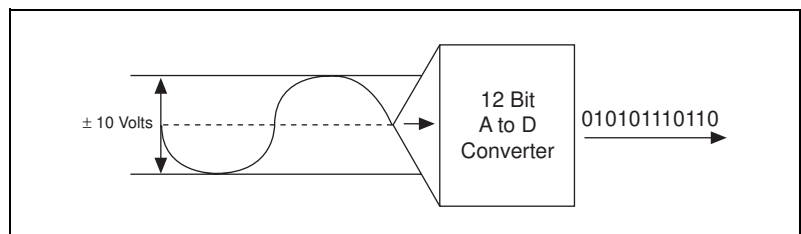

Figure 4-3. ADC Input Resources

The eight ADC channels are multiplexed and automatically scanned to keep the converted ADC register values current. For information about controlling the number of enabled ADCs and the corresponding scan rate, refer to the [Enable ADCs](#) function. Table 4-3 lists the resource IDs for ADCs.

Table 4-3. ADC Resource IDs

Resource Name	Resource ID
ADC 1	0x51
ADC 2	0x52
ADC 3	0x53
ADC 4	0x54
ADC 5	0x55
ADC 6	0x56
ADC 7	0x57
ADC 8	0x58

ADC channels do not typically provide the same level of feedback performance as encoders, but have the advantage of providing absolute rather than incremental feedback.

On 7344 controllers, ADCs 5 through 8 are hard-wired to specific sources, and cannot be used as general-purpose resources or as feedback devices. See the [Read ADC](#) function for more information.

DAC Outputs

DAC resources are typically mapped to servo axes and generate the analog control outputs from the PID loops. DAC resources that are not used by axes are available for non-axis specific applications. You can directly control an unmapped DAC as a general-purpose analog output.

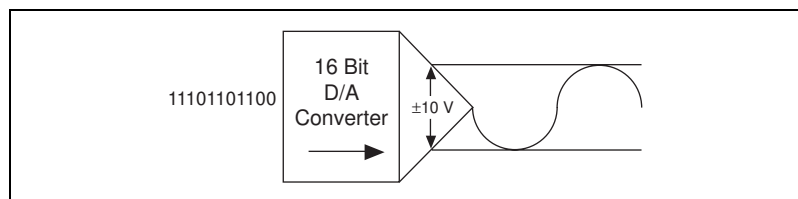

Figure 4-4. DAC Output Resources

The DAC outputs offer 16-bit resolution and the industry-standard ± 10 V range. Refer to Appendix A, *Specifications*, of your motion controller user manual for complete DAC output specifications. Table 4-4 lists the resource IDs for DACs.

Table 4-4. DAC Resource IDs

Resource Name	Resource ID
DAC 1	0x31
DAC 2	0x32
DAC 3	0x33
DAC 4	0x34
DAC 5 (FlexMotion-6C only)	0x35
DAC 6 (FlexMotion-6C only)	0x36

Stepper Outputs

Stepper output resources generate the step pulses required for stepper axis control. They operate like the DAC output in a servo axis.

FlexMotion supports the two industry-standard stepper output configurations: Step and Direction, or CW/CCW pulses. Refer to the [Configure Step Mode & Polarity](#) function for more information on these output configurations. Table 4-5 lists the resource IDs for stepper outputs.

Table 4-5. Stepper Output Resource IDs

Resource Name	Resource ID
Stepper Output 1	0x41 (7344 only)
Stepper Output 2	0x42 (7344 only)
Stepper Output 3	0x43 (7344 only)
Stepper Output 4	0x44 (7344 only)
Stepper Output 5	0x45 (FlexMotion-6C only)
Stepper Output 6	0x46 (FlexMotion-6C only)

General-Purpose I/O Ports

FlexMotion-6C controllers provide 24 bits of general-purpose digital I/O organized into three 8-bit ports. The 7344 controllers have 32 bits of general-purpose digital I/O organized into four 8-bit ports. A fifth RTSI software port is provided as a way to read from and write to the RTSI bus on 7344 controllers. These I/O ports are also hardware resources, but because they are never mapped to axes, they are not considered motion resources.

You can use the general-purpose I/O port structure for programmable logic controller (PLC) functions or for simple point I/O. For information about how to configure the direction and polarity of the I/O ports and bits, set and reset individual bits, and read the logical port status, refer to Chapter 10, *Analog & Digital I/O Functions*. Table 4-6 lists the resource IDs for I/O ports.

Table 4-6. I/O Port Resource IDs

Resource Name	Resource ID
I/O Port 1	1 (0x01)
I/O Port 2	2 (0x02)
I/O Port 3	3 (0x03)
I/O Port 4	4 (0x04) (7344 only)
I/O Port 5	5 (0x05) (7344 only)

Vector Spaces

Vector spaces are logical, multidimensional groups of axes. They can be either one-dimensional, two-dimensional with x and y axes, or three-dimensional with x, y, and z axes. FlexMotion supports up to three vector spaces being defined at the same time.

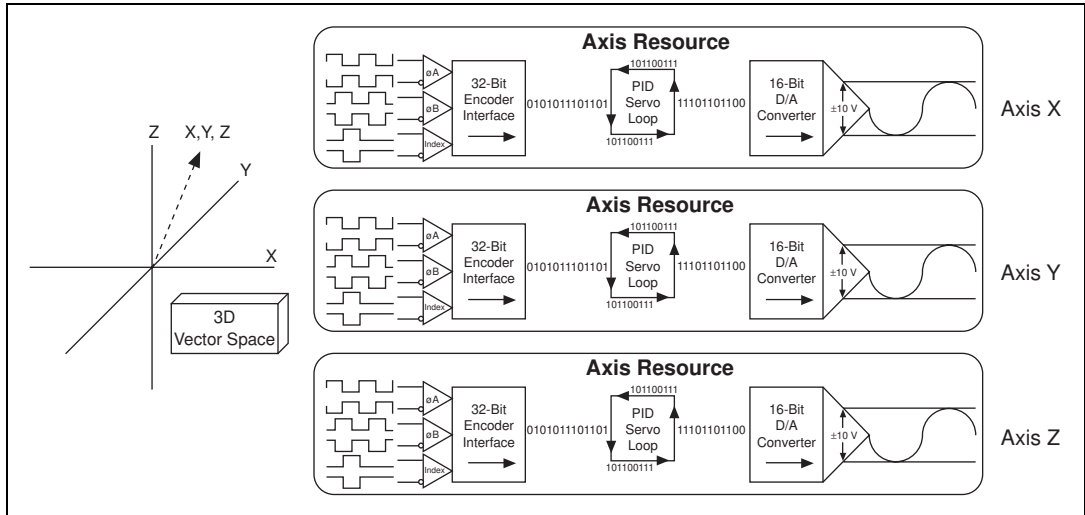

Figure 4-5. 3D Vector Space Resources

Vector spaces facilitate 2D and 3D interpolated moves: linear, circular, helical, and spherical. You can send a vector space to many FlexMotion functions to define vector position, vector velocity, vector acceleration, and so on.

Vector spaces are started, stopped, and controlled as if they were a single axis, greatly simplifying the control of coordinated vector axes. All axes in a vector space will start and stop at the same time, completing the vector motion profiles programmed. Table 4-7 lists the resource IDs for vector space control.

Table 4-7. Vector Space Control Resource IDs

Resource Name	Resource ID
Vector Space Control	0x10
Vector Space 1	0x11
Vector Space 2	0x12
Vector Space 3	0x13

Functions that can operate on multiple vector spaces simultaneously (for example, *Start Motion*) can take the vector space control (0x10) as their resource parameter.

Vector spaces are configured by mapping axes to the vector space with the [Configure Vector Space](#) function. Vector spaces are logical, not physical, and do not require motion resources other than those used by the axes themselves.

Function Types and Parameters

In addition to the API functional organization described previously, FlexMotion functions can be categorized by common format, execution, and parameter characteristics.

Bitmapped versus Per-Resource Functions

There are two basic types of FlexMotion functions—those that operate on one resource (axis, vector space, and so on) at a time, and those that operate on multiple axes, vector spaces, I/O bits, and so on simultaneously.

Per-resource functions typically send numeric values to, or read numeric values from, the selected axis or resource. They operate identically on each axis or member in the resource family.

In contrast, functions that operate on multiple items send and return bitmaps, where each item (axis, vector space, I/O bit, and so on) is represented by one bit in the bitmap. Bitmapped values are always shown in hex (0x prefix) with two characters for a byte value and four characters for a 16-bit word value.

Some functions set and reset bits using the MustOn/MustOff (MOMO) protocol. This tri-state protocol allows you to set/reset one or more bits without affecting the other bits in the bitmap. Refer to Table B-1, [FlexMotion Function Summary](#), in Appendix B, [FlexMotion Functions](#), to help you locate the MOMO functions on this protocol.

Bitmapped functions act on all items simultaneously. You should not use these functions incrementally, because each execution completely reconfigures all items in the bitmap.

Single and Double-Buffered Parameters

Almost all FlexMotion parameters are either single-buffered or double-buffered on the controller. Single-buffered parameters take effect immediately upon function execution and remain in effect until they are overwritten with another call to the function that loaded or set them. It is not necessary to constantly reload single-buffered parameters each time you deal with an axis, vector space, or resource. The obvious exception to this is action commands like [Start Motion](#), [Stop Motion](#), [Find Home](#), and so on, which must be called each time.

Most trajectory control parameters are double-buffered. You can load these parameters on the fly without affecting the move in process. They do not take effect until the next *Start Motion* or *Blend Motion* function is executed. Like single-buffered parameters, the controller retains the values so they do not have to be loaded before each move unless you want to change their values.

Breakpoint position and breakpoint modulus are the only non-trajectory parameters that are also double-buffered. They have no effect until you execute a subsequent *Enable Breakpoint* function.

Input and Return Vectors

Many functions that load values and virtually all readback functions support vectoring. *Load* functions (for example, *Load Target Position*) take an input vector that specifies the source of the data, either immediate (within the function call itself) or from an onboard general-purpose variable. *Read* functions (for example, *Read Position*) take a return vector that specifies the destination for the returned data, either the host computer or an onboard variable.

The ability to use variables in motion control functions is one of the powerful features of the FlexMotion onboard programming environment. You can read data from a resource into a variable, scale or perform some other calculation on the value, and then load the new value as a trajectory or other motion parameter. All data operations functions take data from variables and return the result through a return vector (typically to another variable).



Note Data returned to the host by a return vector of 0xFF is actually left in the Return Data Buffer (RDB). You must then use the *Communicate* function to retrieve the value from the RDB.

Input and return vectors are very useful when writing onboard programs but have little or no use in programs running on the host computer. For this reason, the default value for input vector is immediate (0xFF) and the API includes a second `_rtn` version for all *Read* functions. This version automatically retrieves the data from the RDB after requesting it and returns it by reference to the output parameter.



Note The suffix `_rtn` on the function indicates that the data should be returned to the host. When this calling convention is used, no returnVector is required.

For information about the RDB, refer to the *Communication between the Host Computer and the FlexMotion Controller* section of this chapter.

Onboard Variables

FlexMotion supports 120 general-purpose variables (0x01 through 0x78) for use in onboard programs. Variables are 32 bits wide and can hold either signed (i32) or unsigned (u32) values. Variables can be referenced in input and return vector parameters. Data Operations functions use variables exclusively for input operands and the output result.

In general, most functions have a single data parameter that fits into a single 32-bit variable. If the function uses only a 16-bit data value, it is right shifted within the 32-bit variable. Some functions with input or return vectors have more than one data parameter, however. As a general rule, each parameter, regardless of size, requires its own variable. For these functions, the vector points to the first variable in a sequential group of variables. Parameters are then associated with variables in sequential order.

A few advanced functions handle variables differently from the previous description. Refer to Appendix D, *Onboard Variables, Input, and Return Vectors*, for more information on variables and vectors.



Note You can save the entire set of onboard general-purpose variables to Flash ROM with the *Save Default Parameters* function.

Initialization Overview

The FlexMotion controller has a factory-default configuration that applies to a number of typical motion control applications. However, because the range of possible applications for FlexMotion is endless, you will probably have to initialize your controller with settings appropriate to your application before executing axis motion. Appendix C, *Default Parameters*, gives a complete list of the factory-default values.

A large number of motion parameters need to be set only once during initialization. These parameters deal with the physical setup of the application and are unlikely to change during the application. However, you can change all FlexMotion parameters on the fly as necessary to tailor the motion control.

Once these setup and initialization parameters are chosen, you can save them as customized power-up defaults with the *Save Default Parameters* function.

Recommended Initialization Procedure

This section presents a recommended list of functions you should execute for system-level and per-axis initialization in the order you should call them. This recommended list covers the minimum areas of initialization for basic motion control. You can add additional functions to this list for enhanced system configuration requirements.

System Configuration

1. [Clear Power Up Status](#) (always required)
2. [Configure Axis Resources](#)
3. [Enable Axes](#)

Motion I/O Configuration

4. [Configure Inhibit Outputs](#)
5. [Set Limit Input Polarity](#)
6. [Set Home Input Polarity](#)
7. [Enable Limits](#)
8. [Enable Home Inputs](#)

Per-Axis Configuration

9. [Configure Step Mode & Polarity](#) (stepper axes only)
10. [Load Counts/Steps per Revolution](#) (closed-loop axes only)
11. [Load All PID Parameters](#) (servo axes only)
12. [Set Stepper Loop Mode](#) (stepper axes only)

Initialize Trajectory Parameters (Per-Axis)

13. [Set Operation Mode](#)
14. [Load Following Error](#) (closed-loop axes only)
15. [Load Velocity](#)
16. [Load Acceleration/Deceleration](#)

Establish a Position Reference (Per-Axis)

17. [Find Home](#) (requires configured and enabled limit and home inputs)
18. [Find Index](#) (closed-loop axes only)
19. [Reset Position](#)

At power-up, all axes are automatically stopped, or killed when the axis circuits are disabled (when the motor is off). You must always execute a *Clear Power Up Status* function before attempting to initialize or control the FlexMotion controller. This power-up state is for safety and cannot be bypassed by saving custom defaults. A power cycle also resets velocity override back to 100%.

An axis automatically starts to servo (servo axes) or the motor is energized (stepper axes) when you execute a *Start Motion*, *Blend Motion*, *Stop Motion* (halt type), *Find Home*, or *Find Index* function.

Depending upon your application requirements, you may need to configure the general-purpose I/O ports, enable the ADCs, and so on. Refer to the API function description in chapters 5 through 13 for more information on each setup and configuration function.

Motion Trajectories

This section covers features related to motion trajectories, starting and stopping motion, and the circumstances under which an axis is automatically stopped or killed. It also discusses how the internal representation for some trajectory parameters differs from their API and how this affects their range and resolution.

Trajectory generators are responsible for calculating the instantaneous position command that controls acceleration and velocity while it moves the axis to its target position. This command is then sent to the PID servo loop or stepper pulse generator, depending on axis configuration.

Trajectory Types and Modes

To program a motion trajectory, set the operation mode, load the double-buffered trajectory parameters, then execute the *Start Motion* or *Blend Motion* function.

Trapezoidal Point-to-Point Position Control

FlexMotion implements an industry-standard trapezoidal profile control for point-to-point moves. FlexMotion has enhanced the trapezoidal profile to offer independent acceleration and deceleration value programming and s-curve smoothing (jerk control) of the (acceleration/deceleration) inflection points.

Motion occurs first with a programmable acceleration (smoothed by the s-curve value), then for a period at a constant velocity (if required) and then with a programmed deceleration, stopping at the desired target position. You can interrupt motion by executing a *Stop Motion* function. Motion is automatically halt-stopped if an enabled limit or home input signal becomes active during a motion trajectory controlled move. On closed-loop axes, if the following error trip point is exceeded, the axis is killed.

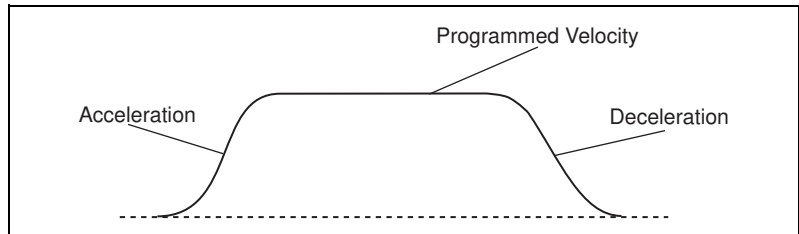

Figure 4-6. Trapezoidal Trajectory with S-Curve Acceleration

You can specify trapezoidal moves as absolute, relative, relative to captured position, or modulo with the *Set Operation Mode* function.

Velocity Control

Velocity control is a simple variation of trapezoidal position-based control. The same trajectory generator implements a continuous velocity control mode. If you select this mode, the target position is effectively infinity and the axis moves at the programmed constant velocity. You can change velocity on the fly and all existing acceleration, deceleration, and s-curve limits are applied to the new velocity in a trapezoidal velocity adjustment. You can interrupt motion by executing a *Stop Motion* function. Motion is automatically halt-stopped if an enabled limit or home input signal becomes active. This mode is useful for jogging, simple speed control and velocity profiling (regular updating of velocity) for continuous path contouring applications.

Move Blending

FlexMotion can blend moves together with a programmable blend factor. The FlexMotion Infinite Trajectory Control Processing allows you to automatically and smoothly blend any move type into any other move without stopping the axis or axes involved.

For more information, refer to the *Blend Motion* function in Chapter 7, *Start & Stop Motion Functions*.

Electronic Gearing

With electronic gearing, you can slave both position and velocity on one or more axes to a master position/velocity source for synchronous ratio-based motion. The master can be the feedback of an axis, an independent encoder input, ADC channel, or even the trajectory generator output of another axis.

A slave axis operates in a special mode that calculates an instantaneous position command value that is a ratio of the master axis position.

Because this calculation is completed every PID cycle, the axis accurately tracks the ratio of the master velocity. For example, setting a gear ratio of 3:2 results in the slave axis rotating three revolutions for every two revolutions of the master. Each slave axis can have its own gear ratio independent and relative to the master axis.

You can also superimpose any move type on top of the geared slave because its trajectory generators are not used for gearing. Again, the target position command values are combined digitally using superposition. This very powerful feature allows registration moves in an electronically geared, master/slave system.

For more information, refer to the [Gearing Functions](#) section in Chapter 6, [Trajectory Control Functions](#).

Linear and Circular Interpolation

You can group multiple axes into vector spaces and perform 2D and 3D linear interpolation, 2D circular interpolation, and 3D helical and spherical interpolation.

The FlexMotion Infinite Trajectory Control Processing allows you to blend any interpolated move segment into another without stopping the axes involved.

You can interrupt interpolated moves by executing a [Stop Motion](#) function. Motion is automatically halt-stopped on an axis if an enabled limit or home input becomes active. The other axes in the vector space decelerate to a stop. Similarly, if any closed-loop axis exceeds its following error trip point, the axis is killed and the other axes in the vector space decelerate to a stop.

For more information, refer to the [Arcs Functions](#) section in Chapter 6, [Trajectory Control Functions](#).

Pull-in Moves

In closed-loop stepper systems, any lost steps (that are not enough to cause a following error trip) are made up with a final pull-in move. This move is automatic and does not require a *Start Motion* or *Blend Motion* function execution.

Trajectory Parameters

All trajectory parameters for servo and closed-loop stepper axes are expressed in terms of quadrature encoder counts. Parameters for open-loop stepper axes are expressed in steps. For servo axes, the encoder resolution in counts per revolution determines the ultimate positional resolution of the axis.

For stepper axes, the number of steps per revolution depends upon the type of stepper driver and motor being used. For example, a stepper motor with $1.8^\circ/\text{step}$ (200 steps/revolution) used in conjunction with a 10x microstep driver would have an effective resolution of 2,000 steps per revolution. Resolution on closed-loop stepper axes is limited to the steps per revolution or encoder counts per revolution, whichever is more coarse.

There are two other factors that affect the way trajectory parameters are loaded to the FlexMotion controller versus how they are used by the trajectory generators: floating-point versus fixed-point parameter representation, and time base.

You can load some trajectory parameters as either floating-point or fixed-point values. The internal representation on the FlexMotion controller is always fixed point, however. This fact is important when working with onboard variables, input, and return vectors. It also has a small effect on parameter range and resolution, as shown in the following examples.

The second factor is the time base. Velocity and acceleration values are loaded in counts/s, RPM, RPS/s, steps/s, and so on—all functions of seconds or minutes. But the trajectory generators update target position at the Trajectory Update Rate, which is programmable with the *Enable Axes* function. This means that the range for these parameters depends on the update rate selected, as shown in the following examples.

Velocity in RPM

Velocity values in RPM are converted to an internal 16.16 fixed-point format in units of counts (steps) per sample period (update period) before being used by the trajectory generator. FlexMotion can control velocity to 1/65,536 of a count or step per sample. You can calculate this minimum velocity increment in RPM with the following formula:

$$\text{RPM} = V_{min} \times (1/T_s) \times 60 \times (1/R)$$

where $V_{min} = 1/65,536$ count/sample or step/sample,
 T_s = sample period in seconds per sample,
 60 = number of seconds in a minute, and
 R = counts or steps per revolution.

For a typical servo axis with 2,000 counts per revolution operating at the 250 μ s update rate, the minimum RPM increment is:

$$(1/65,536) \times 4,000 \times 60/2,000 = 0.00183105 \text{ RPM}$$

RPM values stored in onboard variables are in double-precision IEEE format (f64). For information about the number of variables required to hold an RPM value, refer to Appendix D, *Onboard Variables, Input, and Return Vectors*.

Velocity in Counts/s or Steps/s

Velocity values in counts/s or steps/s are also converted to the internal 16.16 fixed-point format in units of counts or steps per sample (update) period before being used by the trajectory generator. Although FlexMotion can control velocity to 1/65,536 of a count or step per sample, you can see from the following formula that it is impossible to load a value that small with the *Load Velocity* function:

$$\text{Velocity in counts or steps/s} = V_{min} \times (1/T_s)$$

where $V_{min} = 1/65,536$ counts/sample or steps/sample and
 T_s = sample period in seconds per sample.

Even at the fastest update rate, $T_s = 62.5 \times 10^{-6}$:

$$(1/65,536) \times 16,000 = 0.244 \text{ counts or steps/s}$$

The *Load Velocity* function takes an integer input with a minimum value of 1 count/s or step/s. You cannot load fractional values. If you need to load a velocity slower than one count or step per second, use the *Load Velocity in RPM* function.

Acceleration in RPS/s

Acceleration and deceleration values in RPS/s are converted to an internal 16.16 fixed-point format in units of counts/sample² or steps/sample² before being used by the trajectory generator. You can calculate the minimum acceleration increment in RPS/s with the following formula:

$$\text{RPS/s} = A_{\text{min}} \times (1/T_s)^2 \times (1/R)$$

where $A_{\text{min}} = 1/65,536$ counts/sample² or steps/sample²,
 T_s = sample period in seconds per sample, and
 R = counts or steps per revolution.

For a typical servo axis with 2,000 counts per revolution operating at the 250 ms update rate, the minimum RPS/s increment is calculated as follows:

$$(1/65,536) \times (4,000)^2/2,000 = 0.122070 \text{ RPS/s}$$

RPS/s values stored in onboard variables are in double-precision IEEE format (f64). For information about the number of variables required to hold an RPS/s value, refer to Appendix D, *Onboard Variables, Input, and Return Vectors*.

Velocity Override in Percent

While the *Load Velocity Override* function takes a single-precision floating-point (f32) data value from 0 to 150%, velocity override is internally implemented as a velocity scale factor of 0 to 384 with an implicit fixed denominator of 256. This is done for the sake of calculation speed—the denominator is a simple shift right by eight bits.

The resolution for velocity override is therefore limited to 1/256 or about 0.39%.



Note The conversion from floating-point to fixed-point is performed on the host computer, not on the FlexMotion controller. To load velocity override from an onboard variable, you must use the integer representation of 0 to 384.

Arc Angles in Degrees

The *Load Circular Arc*, *Load Helical Arc*, and *Load Spherical Arc* functions take their angle parameters in degrees as double-precision floating-point values. These values are converted to an internal 16.16 fixed-point representation where the integer part corresponds to multiples of 45° (for example, 360° is represented as 0x0008 0000).

The conversion from floating-point to fixed point is performed as follows:

$$\text{Angle (in degrees)}/45^\circ = Q + R$$

where Q = quotient, the integer multiple of 45° and
 R = remainder.

$$\text{Angle (in 16.16 format)} = Q.(R/45^\circ \times 65,536)$$

For example, 94.7° is represented in 16.16 format as follows:

$$\text{Angle (in 16.16 format)} = 2.(4.7^\circ/45^\circ \times 65,536) = 0x0002.1ABD$$

The minimum angular increment is therefore $(1/65,536) \times 45^\circ = 0.000687^\circ$.



Note The conversion from floating-point to fixed-point is performed on the host computer, not on the FlexMotion controller. To load arc functions from onboard variables, you must use the 16.16 fixed-point representation for all angles.

Communication between the Host Computer and the FlexMotion Controller

The host computer communicates with a FlexMotion controller through a number of I/O port addresses on the ISA or PCI bus.

At the controller's base address is the primary bidirectional data transfer port. This port supports FIFO data passing in both send and readback directions. The FlexMotion controller has both a command buffer for incoming commands and a Return Data Buffer (RDB) for return data.

At offsets from the controller's base address are two read-only status registers. The flow of communication between the host and the FlexMotion controller is controlled by handshaking bits in the Communication Status Register (CSR). The Move Complete Status (MCS) register provides instantaneous motion status of all axes.

Board ID

Measurement & Automation Explorer assigns a unique boardID to each motion controller in your system. Once this assignment is made, all FlexMotion API functions use this boardID to send and receive commands and data to/from a specific FlexMotion controller.

Packets, Handshaking, and FIFO Buffers

This section briefly describes how commands and data are passed between the host computer and the FlexMotion controller. This information is provided for reference purposes. The FlexMotion software provides drivers, DLLs, and C function libraries that handle the host-to-controller communication for you.

Data passed to or from the FlexMotion controller is handled in a packet format. A packet consists of a packet identifier word, command and data content, and a packet terminator word. This approach to communication enhances the integrity of data communication, speeds the processing of the transferred command and data, and organizes operation into powerful, high-level functions.

Each word in a packet is sent over the bus after checking the Ready-to-Receive (RTR) handshaking bit in the CSR. See the [Read Communication Status](#) function for the status bitmap and more information on the status reported in the CSR.

Command and data packets are checked for packet format errors as they are received by the controller. If a packet error is detected, it is immediately reported by setting an error bit in the CSR. Once the packet is received without error, the command and data is stored in a FIFO buffer.

This FIFO can hold up to 16 commands. The FlexMotion RTOS will process commands whenever it is not busy with higher priority tasks. In the unlikely event that the FIFO fills up before any commands can be processed, the host will be held off with a Not-Ready-to-Receive condition.

Each command is processed and a determination is made whether to execute the command immediately, or store it away in a program to be executed later. Commands are also checked for data and modal (sequence) errors at this time. Modal errors are flagged by setting the Error Message bit in the CSR. This modal error is functionally different from the packet communication error previously described. See the [Errors and Error Handling](#) section of this chapter for more information.

Return Data Buffer

Data or status requested by the host is buffered in the Return Data FIFO Buffer (RDB). The RDB is 26 words deep and is large enough to hold the biggest return data packet or many smaller return data packets.

When data exists in the RDB, the Ready-to-Send bit in the CSR is set. You can then use the *Communicate* function in mode 2 to retrieve the data from the RDB.

You can use the RDB in two ways—as a temporary buffer holding a single return data packet, or as a small FIFO buffer. Typically, once the requested data is available in the RDB, it is read back by the host. The `_rtn` version of each *Read* function (for example, `flex_read_pos_rtn`) performs this type of synchronous communication for you. The function will not complete until the requested data is placed in the RDB by the FlexMotion controller and is then read from the RDB by the function.

It is possible however, to request a number of pieces of data and leave them in the buffer for retrieval at a later time. The FlexMotion Software supports both ways of using the RDB.

If the RDB fills up and there is no place to put requested return data, FlexMotion generates an error and sets the Error Message bit in the CSR.

Errors and Error Handling

To minimize the possibility of erroneous system operation, functions, packets, and data are checked for errors at multiple levels within the FlexMotion software and within the firmware that resides on the FlexMotion controller itself.

In a perfect system, errors should not be generated. However, during application development and debugging, errors are unfortunately quite common. FlexMotion offers an extensive error handling structure and utility functions to allow you to quickly get to the bottom of any error-generating situation. Refer to Chapter 11, *Error & Utility Functions*, and Appendix A, *Error Codes*, for additional error handling information.

Modal and Non-Modal Errors

FlexMotion can detect two types of errors—modal and non-modal. Non-modal errors are errors detected at the time of function execution. This includes packet errors, communication failures, bad Board ID error, data and resource range errors, and so on.

Each FlexMotion function returns a status that indicates whether the function executed successfully. A non-zero return status indicates that the function failed to execute and the status value returned is the non-modal error code.

Modal errors, on the other hand, are errors that are not detected at the time of function execution. Because functions can be buffered in the onboard FIFO, it is not possible to detect all potential errors at the time of function execution. Furthermore, some functions can be legal at one time and illegal at another, depending on the state or mode of the FlexMotion controller. All errors of these types are classified as modal errors. This modal error structure also correctly detects errors generated by incorrectly sequenced functions in onboard programs.

Error Message Stack

Modal errors cannot be enunciated in a function return status. Instead, they generate an error message containing the command ID, resource ID, and error code that is pushed on the Error Message Stack on the FlexMotion controller and flagged in the Error Message (Err Msg) bit of the Communication Status Register (CSR). You can return a modal error message to the host by executing the *Read Error Message* function.

The Error Message Stack is organized as a last-in-first-out (LIFO) buffer so that the most recent error is available immediately. Older errors can be read with additional calls to the *Read Error Message* function and are returned in the inverse order to which they were generated. When the stack is empty, the Error Message (Err Msg) bit in the CSR is reset.

The Error Stack can hold up to 30 errors. When the stack is full (an unlikely event), additional error messages are thrown away.

Communicate versus Individual Function Entry Points

The FlexMotion software offers individual entry points for each API function plus a single entry point function, *Communicate*, which can send any function packet. The individual entry points perform more extensive error checking than *Communicate* because they are aware of the function context. Therefore, more errors can be caught as non-modal errors.

When you use the *Communicate* entry point, all errors except packet errors, bad Board ID error, and communication failure are reported as modal errors.

Onboard Programs

Functions stored in onboard programs are checked twice for errors. The first time is when you are storing the function in the program. You can detect both non-modal and modal errors during program storage, depending on the level of command FIFO usage and whether you are calling the individual API entry points or calling the *Communicate* function.

When the program is run, the stored functions are again checked for errors. Only modal errors are generated during program execution.



Note If the host or onboard program is correctly written, you should not see any packet or modal errors. These error handling structures are used mostly during application development and debugging.

Fatal Hardware and Communication Errors

There are a few errors that, if detected, indicate a severe or fatal error condition. These include but are not limited to `NIMC_boardFailureError`, `NIMC_watchdogTimeoutError`, `NIMC_FPGAProgramError`, `NIMC_DSPInitializationError`, `NIMC_IOInitializationError`, and `NIMC_readyToReceiveTimeoutError`. Refer to Appendix A, *Error Codes*, for a complete list of error codes and possible causes.

Fatal errors are unlikely, but if they occur, try to clear them by resetting or power cycling. If this procedure does not clear the problem, refer to Appendix E, *Technical Support Resources*.

Error Handling Techniques

Be sure to constantly watch for error conditions. You should always check the function return status for a non-zero error code and react to the error as appropriate. These non-modal errors are easily handled like any other function error in C/C++ or other programming languages. The FlexMotion software includes a utility function, *Get Error Description*, which you can use to create error description strings for display.

Modal error handling is a bit more involved. Because these errors are rare but can occur at any time, your application should check for modal errors at various intervals. This is done by calling the *Read Communication Status* function and checking the Error Message bit. How often to check for modal

errors depends upon your application, but you can use the following list as a guideline:

1. Check for modal errors at the end of each major subroutine or functional block.
2. Check for modal errors at the end of an initialization procedure. Even better is to also check after each axis initialization. You should always check after executing a *Find Home* or *Find Index* function to make sure the sequence completed successfully.
3. Include a modal error check in every status polling loop. Most applications include a polling loop to display motion status, position, velocity, and so on. This way you are assured of never missing a modal error.
4. You can always add a modal error check after each FlexMotion API call, but that is inefficient and unnecessary. Remember that a correctly written program will not generate errors.
5. During debugging, you can run an independent application to check for modal errors. The FlexCommander application always checks modal errors for you when it is running.

Refer to the example programs, included with the FlexMotion software, to see how error handling is implemented in practice.

Axis & Resource Configuration Functions

This chapter contains detailed function descriptions of the functions used to configure the axes and resources on your FlexMotion controller. The functions are arranged alphabetically by function name.

These functions give you access to some of the most powerful features of FlexMotion. They allow you to map encoder, ADC, and DAC resources to various axes, configure axes for servo or stepper control, and combine axes into 2D and 3D vector spaces for advanced motion control applications.

These axis and resource configuration functions are typically executed once during system initialization. You can call most of them at any time to reconfigure your motion control system on-the-fly. All of the functions in this chapter have default values that provide good starting points for many motion control applications.

As a quick reference, a summary of the entire FlexMotion function API is in Appendix B, *FlexMotion Functions*.

flex_config_axis

Configure Axis Resources

Format

status = flex_config_axis (**boardID**, **axis**, **primaryFeedback**, **secondaryFeedback**, **primaryOutput**, **secondaryOutput**)

Purpose

Configures an axis by defining its feedback and output resources.

Parameters

Input

Name	Type	Description
boardID	u8	assigned by Measurement & Automation Explorer
axis	u8	axis to be configured
primaryFeedback	u8	primary encoder or ADC feedback resource
secondaryFeedback	u8	secondary encoder or ADC feedback resource
primaryOutput	u8	primary DAC or step output resource
secondaryOutput	u8	secondary DAC or step output resource

Parameter Discussion

axis is the axis to be configured. Valid axis numbers are 1 through 6 for all FlexMotion controllers. On reduced axis count controllers, configuring non-existent axes will have no effect.

primaryFeedback is the number for the primary feedback resource being mapped to the axis. The primary feedback resource is used for position feedback and derivative (Kd) damping. Valid feedback resources include encoders (0x21 through 0x26 on FlexMotion-6C controllers and 0x21 through 0x24 on 7344 controllers) and ADC channels (0x51 through 0x58 on FlexMotion-6C controllers and 0x51 through 0x54 on 7344 controllers). Enter 0 (zero) to configure no primary feedback resource.

secondaryFeedback is the number for an optional secondary feedback resource being mapped to the axis. If a secondary feedback resource is mapped, it is used for velocity feedback (Kv). Valid feedback resources include encoders (0x21 through 0x26 on FlexMotion-6C controllers and 0x21 through 0x24 on 7344 controllers) and ADC channels

(0x51 through 0x58 on FlexMotion-6C controllers and 0x51 through 0x54 on 7344 controllers). Enter 0 (zero) to configure no secondary feedback resource.

primaryOutput is the number for the primary output resource being mapped to the axis. This is the main command output. Valid output resources include DACs (0x31 through 0x36 on FlexMotion-6C controllers and 0x31 through 0x34 on 7344 controllers) and Step Outputs (0x45 through 0x46 on FlexMotion-6C controllers and 0x41 through 0x44 on 7344 controllers). Enter 0 (zero) to configure no primary output resource.

secondaryOutput is the number for an optional secondary output resource being mapped to the axis. This is an optional command output. Valid output resources include DACs (0x31 through 0x36 on FlexMotion-6C controllers and 0x31 through 0x34 on 7344 controllers) and Step Outputs (0x45 through 0x46 on FlexMotion-6C controllers and 0x41 through 0x44 on 7344 controllers). Enter 0 (zero) to configure no secondary output resource.

Using This Function

The *Configure Axis Resources* function defines the feedback and output devices for an axis. You can configure up to two feedback resources and two output resources for each axis. This flexible mapping of resources to axes allows for advanced servo and stepper configurations such as: independent velocity and position feedback devices (dual-loop control), dual DAC outputs with different offsets, and so on.

The various feedback and output resources on the FlexMotion controller have different interface, performance, and functionality characteristics. This function allows you to define the axis and tailor its performance.

The *Configure Axis Resources* function must be called for each axis that will be used by an application prior to enabling the axis. The factory default mapping of resources to axes is as follows.

Axis	Primary Feedback	Secondary Feedback	Primary Output	Secondary Output
1	0x21 (Enc 1)	0	0x31 (DAC 1)	0
2	0x22 (Enc 2)	0	0x32 (DAC 2)	0
3	0x23 (Enc 3)	0	0x33 (DAC 3)	0
4	0x24 (Enc 4)	0	0x34 (DAC 4)	0
5	0x25 (Enc 5)	0	0x35 (DAC 5)	0
6	0x26 (Enc 6)	0	0x36 (DAC 6)	0



Note You cannot configure an axis when any axes are enabled. You must first disable all axes using the [Enable Axes](#) function.

Example 1

To change axis 5 to use the fourth encoder channel and the sixth DAC output, call the [Configure Axis Resources](#) function with the following parameters.

Axis	Primary Feedback	Secondary Feedback	Primary Output	Secondary Output
5	0x24 (Enc 4)	0	0x36 (DAC 6)	0

To avoid potential contention for output resources, this VI will always honor the configuration of the last time it is called. In this example, both axis 6 (by default) and axis 5 want to use DAC 6. Similarly, both axis 4 (by default) and axis 5 want to use encoder 4. To avoid contention, DAC 6 is assigned to axis 5 and removed from axis 6, and encoder 4 is assigned to axis 5 and removed from axis 4, resulting in the following parameters.

Axis	Primary Feedback	Secondary Feedback	Primary Output	Secondary Output
4	0	0	0x34 (DAC 4)	0
6	0x26 (Enc 6)	0	0	0

You must now call this VI again to configure axis 4 with a different feedback resource and axis 6 with a different output resource.

Example 2

To configure axis 2 for dual-loop feedback you can use the following parameters.

Axis	Primary Feedback	Secondary Feedback	Primary Output	Secondary Output
2	0x51 (ADC 1)	0x22 (Enc 2)	0x32 (DAC 2)	0

In this example, an ADC channel is used for the primary position feedback (k_p , k_i , k_d) while an encoder is used for the secondary velocity feedback. This application will typically use velocity feedback (K_v) from the encoder for stability. For information about setting K_v , refer the [Load Single PID Parameter](#) function.



Note Stepper axes do not support dual-loop feedback and cannot have a secondary feedback resource configured.

flex_config_mc_criteria

Configure Move Complete Criteria

Format

`status = flex_config_mc_criteria (boardID, axis, criteria, deadband, delay, minPulse)`

Purpose

Configures the criteria for the Move Complete status to be True.

Parameters

Input

Name	Type	Description
boardID	u8	assigned by Measurement & Automation Explorer
axis	u8	axis to be configured
criteria	u16	conditions that must be met for the MC status to be True
deadBand	u16	tolerance area around target position
delay	u8	settling time delay in ms
minPulse	u8	minimum time the MC status must stay true in ms

Parameter Discussion

axis is the axis to be configured.

criteria is the bitmap that defines the criteria for the move complete status to be True.

D15	D14	D13	D12	D11	D10	D9	D8	D7	D6	D5	D4	D3	D2	D1	D0
0	0	0	0	0	0	0	0	0	0	0	In Pos	Delay	Stop	MOff	PC

D0 Profile Complete (PC):

1 = Profile must be complete (default)

0 = N/A (cannot reset)

D1 Motor Off (MOff):

1 = Motor must be off

0 = Motor off status not considered (default)

D2 Stop:

- 1 = Run/Stop must be stopped
- 0 = Run/Stop not considered (default)

D3 Delay:

- 1 = Move complete only after delay
- 0 = Move complete not delayed (default)

D4 In Position (In Pos):

- 1 = Must be within deadband of target position
- 0 = Ignore in position status (default)

The effect of the criteria parameter can be summarized with the following equation:

$$\begin{aligned} \text{Move Complete} = & (\text{Profile Complete [OR Motor Off]}) \\ & [\text{AND (Run/ Stop == Stop)}] \\ & [\text{AND (Delay == Done)}] \\ & [\text{AND (| position - target position | < deadband)}] \end{aligned}$$

where [...] = optional criteria.

deadband is the tolerance around the target position. If selected, the move is only considered complete when $|\text{position} - \text{target position}| < \text{deadband}$. Deadband has a range of 0 (default) to 32,767.

delay is a programmable settling time delay in ms. You can program it from 0 (default) to 255 ms.

minPulse is the minimum time in ms that the move complete status must stay true. This parameter allows you to enforce a minimum pulse width on the move complete status even if the axis is started again. The range is 0 (default) to 255 ms.

Using This Function

The [Configure Move Complete Criteria](#) function defines the conditions for reporting a move complete. When a move is complete on an axis, the corresponding bit in the Move Complete Status (MCS) register is set. For information about reading the MCS register, refer to the [Read Move Complete Status](#) function.

This function allows a great deal of control over when and how a move is considered complete. The Criteria bitmap contains five bits to set the conditions used to determine the Move Complete status. The first two, Profile Complete and Motor Off, are logically OR'd to provide the basis for Move Complete. The Profile Complete bit is always set and cannot be disabled. When the axis trajectory generator completes its profile, this condition is satisfied.

If the Motor Off bit is set, any condition that causes the axis to turn its motor off (a kill or following error trip) will satisfy this basic requirement for Move Complete. In other words, either Profile Complete OR Motor Off must be True for Move Complete to be True.

The next three criteria, Run/Stop, Delay, and In Position, are optional conditions that are logically AND'd to further qualify the Move Complete status. If the Run/Stop bit is set, the axis must also be logically stopped for the move to be considered complete. For information about the Run/Stop status, refer to the [Configure Velocity Filter](#) function.

If the Delay bit is set, the axis must wait a user-defined delay after the other criteria are met before the move is considered complete. The user-defined **delay** parameter is typically used to wait the mechanical settling time so that a move is not considered complete until vibrations in the mechanical system have damped out. It can also be used to compensate for PID pull-in time due to the integral term. This pull-in is typically at velocities below the Run/Stop threshold.

Finally, if the In Position bit is set, the axis checks its final stopping position versus its target position and only sets the Move Complete status if the absolute value of the difference is less than the in position deadband.

The final parameter, **minPulse** sets the minimum time that the Move Complete status must stay True. A non-zero value for **minPulse** guarantees that the status stays in the True state for at least this minimum time even if another move starts immediately. You can use this feature to make sure that the host does not miss a Move Complete status when it polls the Move Complete Status register.



Note You can use the Delay parameter to guarantee a minimum time for the False state. The status will transition from Complete to Not Complete at the start of a move and stay in the Not Complete state for at least this delay time even in the case of a zero distance move.

The [Configure Move Complete Criteria](#) function is typically called for each axis prior to using the axis for position control. Once the criteria are set, they remain in effect until changed. You can execute this function at any time.

When an axis starts, its corresponding bit in the Move Complete Status register is reset to zero. When the move completes, the bit is set to one. You can check the status of an axis or axes at any time by polling the MCS register. Onboard programs can use this status to automatically sequence moves with the [Wait on Condition](#) function.

flex_config_step_mode_pol

Configure Step Mode & Polarity

Format

status = flex_config_step_mode_pol (boardID, axisOrStepperOutput, modeAndPolarityMap)

Purpose

Configures the mode and polarity of a stepper output.

Parameters

Input

Name	Type	Description
boardID	u8	assigned by Measurement & Automation Explorer
axisOrStepperOutput	u8	axis or stepper output to be configured
modeAndPolarityMap	u16	bitmap of output mode and polarity

Parameter Discussion

axisOrStepperOutput is the axis or stepper output to be configured. When sent to a stepper axis, this function configures the mapped stepper output. Alternatively, you can execute this function directly on the stepper output resource.

modeAndPolarityMap is the output mode and polarity bitmap.

D15	D14	D13	D12	D11	D10	D9	D8	D7	D6	D5	D4	D3	D2	D1	D0
0	0	0	0	0	0	0	0	0	0	0	0	0	Pol	0	Mode

D0 Mode:

1 = Step & Direction (default)

0 = CW & CCW

D1 Reserved

D2 Polarity (Pol):

1 = Inverting (default)

0 = Noninverting

Using This Function

You use this function to configure a stepper output to correctly interface with a stepper driver. FlexMotion supports the two industry standards for stepper control outputs. The most popular mode is Step and Direction where one output produces the step pulses and the other output produces a direction signal.

In clockwise (CW) and counter-clockwise (CCW) mode, the first output produces pulses when moving forward or CW while the second output produces pulses when moving reverse or CCW.

In either mode, you can set the active polarity with the polarity bit to be active low (inverting) or active high (noninverting). For example, in Step and Direction mode, the polarity bit determines whether a high direction output is forward or reverse. It also determines the resting states of outputs when they are not pulsing.

The *Configure Step Mode & Polarity* function is typically called for each stepper axis prior to using the axis for position control. Once the mode and polarity are set, they remain in effect until changed. You can execute this function at any time.

flex_config_vect_spc

Configure Vector Space

Format

status = flex_config_vect_spc (boardID, vectorSpace, xaxis, yaxis, zaxis)

Purpose

Defines the axes that are associated with a vector space.

Parameters

Input

Name	Type	Description
boardID	u8	assigned by Measurement & Automation Explorer
vectorSpace	u8	vector space to be configured
xaxis	u8	physical axis to act as the logical x axis
yaxis	u8	physical axis to act as the logical y axis
zaxis	u8	physical axis to act as the logical z axis

Parameter Discussion

vectorSpace is the vector space to be configured. Valid vector space numbers are 0x11 (default), 0x12 and 0x13.

xaxis is the physical axis (1 through 6) to act as the logical x axis. The default is 0 (none).

yaxis is the physical axis (1 through 6) to act as the logical y axis. The default is 0 (none).

zaxis is the physical axis (1 through 6) to act as the logical z axis. The default is 0 (none).

Using This Function

The *Configure Vector Space* function is used to group axes into a vector space. A vector space defines an x and y (2D) or x, y, and z (3D) coordinate space. You can map any physical axis can be mapped to the logical x, y, and z axes to control motion in the vector space.

Once configured, you can use the vector space number in all functions that support vector spaces. Vector spaces are used in 2D and 3D linear interpolation with vector position, vector velocity, vector acceleration and deceleration, and vector operation mode. They are also used in circular, helical and spherical arc moves. You can start, blend, and stop vector spaces just

like axes. You can even synchronously start multiple vector spaces for multi-vector space coordination.

Many status and data readback functions also operate on vector spaces. You can read vector position, vector velocity, vector blend status, and so on, or you can read per-axis values and status for the axes within the vector space.

While vector spaces can be comprised of three axes, it is possible to define two-axis or even one-axis vector spaces. These vector spaces will function properly for all functions that do not require a greater axis count.

You can use other complex motion control functions with vector spaces, including electronically gearing an independent axis to a master axis contained within a vector space definition.



Note Axes cannot belong to two vector spaces at the same time. To move an axis from one vector space to another, you must de-map the axis from the first vector space and then map it to the second vector space.

Example

Vector space 2 (0x12) is configured with axis 3 as the x axis, axis 1 as the y axis, and axis 2 as the z axis. The resulting 3D vector space is shown in Figure 5-1.

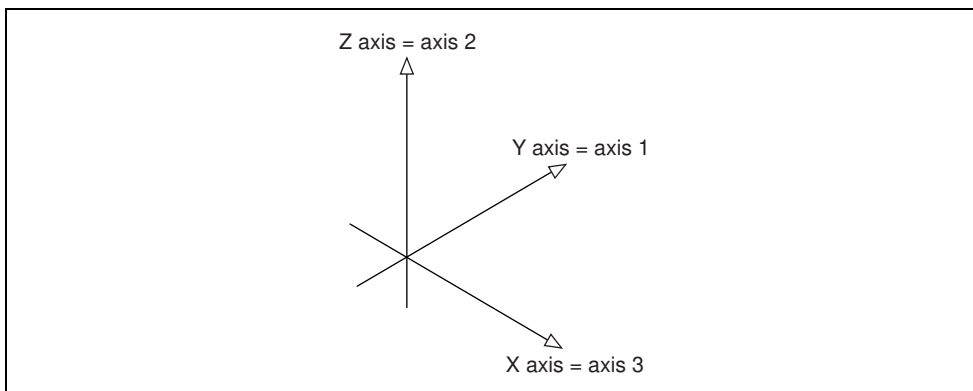

Figure 5-1. 3-D Vector Space Example

flex_enable_axes

Enable Axes

Format

status = flex_enable_axes (boardID, reserved, PIDrate, axisMap)

Purpose

Enables the operating axes and defines the PID and trajectory update rate.

Parameters

Input

Name	Type	Description
boardID	u8	assigned by Measurement & Automation Explorer
reserved	u8	unused input
PIDrate	u8	PID update rate
axisMap	u8	bitmap of axes to enable

Parameter Discussion

reserved is an unused input. The input value is ignored.

PIDrate is the PID control loop and trajectory generator update rate. For stepper axes, this parameter also determines how often the step generator is updated. The range for this parameter is 0 to 7, with a default of 3.

$$\text{Update Rate} = (\text{PIDrate} + 1) \times 62.5 \mu\text{s}$$

PIDrate	Update Rate
0	62.5 μs
1	125 μs
2	188 μs
3	250 μs
4	312 μs
5	375 μs (default)

PIDrate	Update Rate
6	438 μ s
7	500 μ s

axisMap is the bitmap of enabled axes.

D7	D6	D5	D4	D3	D2	D1	D0
0	AXIS 6	AXIS 5	AXIS 4	AXIS 3	AXIS 2	AXIS 1	0

D1 through D6:

1 = Axis enabled

0 = Axis disabled (default)

Using This Function

The *Enable Axes* function is used to enable the specific axes required for the application and set the servo (and stepper) update or sample rate. For highest performance, the FlexMotion trajectory generators calculate a new instantaneous target position each update. Similarly, the stepper pulse generators are adjusted each update to accurately control the step frequency.

Only enabled axes are updated and there is a direct correspondence between the number of enabled axes and the fastest update rate allowed.

Number of Servo Axes Enabled	Fastest Sample Rate	PIDrate (min)
1	62.5 μ s	0
2	125 μ s	1
3	188 μ s	2
4	250 μ s	3
5	312 μ s	4
6	375 μ s	5

The fastest update rate is only achievable when all axes are single-feedback servo axes and no extra encoders are enabled.

Servicing the stepper pulse generators takes extra time that subtracts from the time available for trajectory generation. If one or more axes are configured as stepper, you must increase the **PIDrate** value by one (+1) and operate at the correspondingly slower update rate.

There is also a limit on the total number of enabled encoders that you can service when **PIDrate** is below 3.

PIDrate	Update Rate	Max Number of Encoders
0	62.5 μ s	1
1	125 μ s	3
2	188 μ s	5
3	250 μ s	6

If your application requires more encoders than can be serviced at a specific update rate, you must increase **PIDrate** appropriately.



Caution Update rates that are too fast for the number of axes, stepper outputs and/or encoders enabled will generate an error and the previous setting will remain in effect. For information about errors and error handling, refer to Chapter 4, *Software Overview*.

The *Enable Axes* function will automatically enable the feedback devices mapped to the enabled axes. It is not necessary to explicitly enable the encoders or ADC channels before enabling the axes. Refer to the *Enable Encoders* and *Enable ADCs* functions for more information on enabling and disabling these resources when you are using them not mapped to an axis.



Note ADC channel scan rate is affected by the number of changes enabled. This could limit the effective update rate (for axes with analog feedback). Refer to the *Enable ADCs* function for more information.



Caution Illegally configured axes cannot be enabled and attempting to do so will generate an error. For example, an attempt to enable a servo axis that does not at least have its Primary Feedback device mapped will generate an error.

You can also set the update rate slower than the maximum. This is useful in many applications to scale the effective range of the PID control loop parameters and/or to improve stability. Refer to the *Load Single PID Parameter* function for more information on the PID parameters affected by the update rate.



Note Enabled axes must be killed (motor off) when changing the PID update rate or an error will be generated.

Example

Your application has the following axis requirements: Axis 1 is a servo axis with dual-loop encoder feedback. Axis 2 is a closed-loop stepper axis. You also want to use the remaining 3 encoder channels as digital potentiometer inputs.

You have 2 axes, one of which is stepper. The fastest update rate you can set is as follows:

$$\mathbf{PIDrate} = 1 + 1 \text{ (stepper)} = 2$$

But at a **PIDrate** of 2, the maximum number of encoders is 5 and you need 6. So you must increase **PIDrate** to the following:

$$\mathbf{PIDrate} = 2 + 1 \text{ (too many encoders)} = 3$$

$$\text{Update Rate} = (\mathbf{PIDrate} + 1) \times 62.5 \mu\text{s} = (3 + 1) \times 62.5 \mu\text{s} = 250 \mu\text{s}$$

To enable axes 1 and 2 with an update rate of 250 μs , call the *Enable Axes* function with **PIDrate** = 3 and **axisMap** = 0x06. The value 0x06 corresponds to the following bitmap.

D7	D6	D5	D4	D3	D2	D1	D0
0	AXIS 6	AXIS 5	AXIS 4	AXIS 3	AXIS 2	AXIS 1	0
0	0	0	0	0	1	1	0

You must also enable the extra digital potentiometer encoders with the *Enable Encoders* function.

flex_load_counts_steps_rev

Load Counts/Steps per Revolution

Format

status = flex_load_counts_steps_rev (boardID, axis, unitType, countsOrSteps)

Purpose

Loads the quadrature counts or steps per revolution for an axis.

Parameters

Input

Name	Type	Description
boardID	u8	assigned by Measurement & Automation Explorer
axis	u8	axis to be controlled
unitType	u16	type of information, counts or steps, that is being loaded
countsOrSteps	u32	quadrature counts or steps per revolution

Parameter Discussion

axis is the axis to be controlled.

unitType is the type of information, counts or steps, that is being loaded. The legal values are as follows.

unitType Constant	unitType Value	Action
NIMC_COUNTS	0	load counts per revolution
NIMC_STEPS	1	load steps per revolution

countsOrSteps is typically the quadrature counts or steps per revolution for the encoder mapped to the axis. The range for this parameter is 2 to $2^{28}-1$ with a default value of 2,000.

Using This Function

You use the *Load Counts/Steps per Revolution* function to load any feedback value per unit of measure. For encoders, this is typically in units of quadrature counts per motor revolution, but can be counts per inch, per cm, or per any unit of measure. For analog feedback, it can be in units of scaled voltage. Steps can be full steps, half steps, or microsteps depending upon how you have the external stepper driver and motor configured.

This parameter must be correctly loaded before you call the *Load Velocity in RPM*, *Load Accel/Decel in RPS/sec*, *Load Velocity Threshold in RPM*, *Read Velocity in RPM*, or *Find Index* functions.

The *Find Index* function will search for the encoder index for one revolution as defined by this function. Therefore, another useful unit of measure is counts per index period. Linear encoders often have indexes every inch or every centimeter.

Closed-loop stepper functionality relies on the ratio of counts to steps and not on the absolute values of counts per revolution or steps per revolution. For closed-loop operation, any unit of measure (UOM) that allows you to enter both counts per UOM and steps per UOM that are within their valid ranges will work.



Warning For closed-loop stepper controllers, steps/counts must be in the range of $1/32,767 < \text{steps/counts} < 32,767$.

Other than these special issues with *Find Index* and closed-loop stepper functionality, the *Load Counts/Steps per Revolution* function loads a scale factor that affects subsequently loaded and readback values of velocity and acceleration.

flex_load_pid_parameters

Load All PID Parameters

Format

status = flex_load_pid_parameters (**boardID**, **axis**, **PIDValues**, **inputVector**)

Purpose

Loads all 8 PID control loop parameters for an axis.

Parameters

Input

Name	Type	Description
boardID	u8	assigned by Measurement & Automation Explorer
axis	u8	axis to configure
PIDValues	PID FAR *	data structure containing all 8 PID parameters
inputVector	u8	source of the data for this function

Parameter Discussion

axis is the axis to configure.

PIDValues data structure contains all eight PID parameters in the following structure:

```
struct {
    u16 kp; // Proportional Gain
    u16 ki; // Integral Gain
    u16 il; // Integration Limit
    u16 kd; // Derivative Gain
    u16 td; // Derivative Sample Period
    u16 kv; // Velocity Feedback Gain
    u16 aff; // Acceleration Feedforward Gain
    u16 vff; // Velocity Feedforward Gain
} PID;
```

inputVector indicates the source of the data for this function. Available inputVectors include immediate (0xFF) or variable (0x01 through 0x78).

Using This Function

The *Load All PID Parameters* function allows you to set all eight PID parameters at the same time for a given axis. You can call this function at any time. However, it is typically used during initialization to configure and tune an axis. FlexMotion also offers a *Load Single PID Parameter* function, which you can use to change an individual value on-the-fly without having to worry about the other unchanged values.

Refer to Chapter 4, *Functional Overview*, of your motion controller user manual for an overview of the PID control loop on the FlexMotion controller and to the *Load Single PID Parameter* function for descriptions on the individual PID parameters and their ranges.

flex_load_single_pid_parameter

Load Single PID Parameter

Format

status = flex_load_single_pid_parameter (boardID, axis, parameterType, PIDValue, inputVector)

Purpose

Loads a single PID control loop parameter for an axis.

Parameters

Input

Name	Type	Description
boardID	u8	assigned by Measurement & Automation Explorer
axis	u8	axis to configure
parameterType	u16	selects PID parameter to load
PIDValue	u16	PID value to load
inputVector	u8	source of the data for this function

Parameter Discussion

axis is the axis to configure.

parameterType is the selector for the PID parameter to load.

parameterType Constant	parameterType Value
NIMC_KP	0
NIMC_KI	1
NIMC_IL	2
NIMC_KD	3
NIMC_TD	4
NIMC_KV	5
NIMC_AFF	6
NIMC_VFF	7

PIDValue is the value to load for the selected PID parameter.

PID Parameter	Abbreviation	Data Ranges	Default
Proportional Gain	Kp	0 to 32,767	100
Integral Gain	Ki	0 to 32,767	0
Integration Limit	Ilim	0 to 32,767	1,000
Derivative Gain	Kd	0 to 32,767	1,000
Derivative Sample Period	Td	0 to 63	2
Velocity Feedback Gain	Kv	0 to 32,767	0
Acceleration Feedforward Gain	Aff	0 to 32,767	0
Velocity Feedforward Gain	Vff	0 to 32,767	0

inputVector indicates the source of the data for this function. Available input Vectors include immediate (0xFF) or variable (0x01 through 0x78).

Using This Function

Refer to Chapter 4, *Functional Overview*, of your motion controller user manual for an overview of the enhanced PID control loop on the FlexMotion controller. The [Load Single PID Parameter](#) function allows you to change an individual PID value on-the-fly without having to worry about the other unchanged PID values.

Proportional Gain

The proportional gain (Kp) determines the contribution of restoring force that is directly proportional to the position error. This restoring force functions in much the same way as a spring in a mechanical system.

Each sample period, the PID loop calculates the position error (the difference between the instantaneous trajectory position and the primary feedback position) and multiplies it by Kp to produce the proportional component of the 16-bit DAC command output.

The formula for calculating this proportional contribution is as follows:

$$V_{out}(\text{proportional}) = (20 \text{ V} / 2^{16}) \times K_p \times \text{Position Error}$$

An axis with zero or too small a value of Kp will not be able to hold the axis in position and will be very soft. Increasing Kp stiffens the axis and improves its disturbance torque rejection. However, too large a value of Kp will often result in instability.

Integral Gain

The integral gain (K_i) determines the contribution of restoring force that increases with time and thus ensures that the static position error in the servo loop is forced to zero. This restoring force works against constant torque loads to help achieve zero position error when the axis is stopped.

Each sample period, the position error is added to the accumulation of previous position errors to form an integration sum. This integration sum is scaled by dividing by 256 prior to being multiplied by K_i . Therefore, the formula for calculating the integral contribution in the 16-bit DAC command output is as follows:

$$V_{out}(\text{integral}) = (20 \text{ V} / 2^{16}) \times K_i \times \text{LIMIT}(\text{Integration Sum}/256)$$

where LIMIT = shorthand for the effects of the integration limit described in the following sections.



Note The scaling by $1/256$ allows the use of integer values for the integral gain even when only a small amount of integral contribution is required.

In applications with small static torque loads, this value can be left at its default value of zero (0). For systems having high static torque loads, this value should be tuned to minimize position error when the axis is stopped.

Non-zero values of K_i , while reducing static position error, tend to increase position error while accelerating and decelerating. This effect can be mitigated through the use of the Integration Limit parameter. Too high a value of K_i will often result in servo loop instability. For these reasons, it is recommended that K_i be left at its default value of zero until the servo system operation is stable and then you can add a small amount of K_i to minimize static position errors.



Note K_i has no effect when I_{lim} is equal to zero.

Integration Limit

The integration limit (I_{lim}) is used to clamp the contribution of the integral term in the PID loop. The scaled integration sum is compared to the integration limit and the lesser of the two values is multiplied by K_i to produce the integral term of the control output. This limiting function is indicated with $\text{LIMIT}()$ in the following integral term output equation:

$$V_{out}(\text{integral}) = (20 \text{ V} / 2^{16}) \times K_i \times \text{LIMIT}((\text{Integration Sum}/256), I_{lim})$$

You can use I_{lim} to limit excessive restoring forces and to minimize the adverse effects that integral compensation has during acceleration and deceleration.



Note Ilim has no effect when Ki is equal to zero.

Derivative Gain

The derivative gain (Kd) determines the contribution of restoring force proportional to the rate of change (derivative) of position error. This force acts much like viscous damping in a damped spring and mass mechanical system (for example, shock absorber).

The PID loop computes the derivative of position error every derivative sample period (a multiple of PID sample period; see the following section, [Derivative Sample Period](#)). This derivative term is multiplied by Kd every PID sample period to produce the derivative component of 16-bit DAC command output.

The formula for calculating the derivative contribution is as follows:

$$V_{out}(\text{derivative}) = (20 \text{ V} / 2^{16}) \times K_d \times (\text{pos_err}(t_1) - \text{pos_err}(t_0))$$

where the time between t_1 and t_0 is the derivative sample period.

A non-zero value of Kd is required for all systems that use torque block amplifiers (where the command output is proportional to motor torque) for the servo loop operation to be stable. Too small a Kd value will result in servo loop instability.

With velocity block amplifiers (where the command output is proportional to motor velocity) you typically set Kd to zero or to a very small value.

Derivative Sample Period

The derivative sample period parameter (Td) is used as a multiplier of the PID sample period (PID update rate). For information about setting the PID update rate, refer to the [Enable Axes](#) function. Td determines how often (in update samples) the derivative of position error is calculated.

The formula for calculating the derivative sample period from Td is as follows:

$$\text{Derivative Sample Period} = (T_d + 1) \times \text{PID Sample Period}$$

Because the range for Td is 0 to 63, the shortest derivative sample period is as follows:

$$\text{Derivative Sample Period} = 1 \times 62.5 \mu\text{s} = 62.5 \mu\text{s}$$

The longest derivative sample period is as follows:

$$\text{Derivative Sample Period} = 64 \times 500 \mu\text{s} = 32 \text{ ms}$$

Adjusting Td provides greater flexibility in tuning the PID loop derivative term. As Td is increased, you can use a proportionally lower value of Kd for similar results. You should start

the Td parameter at its default value of 2 and make small adjustments as required by your motion system configuration.

For low inertia systems, Td should be set to a small value (0 or 1) so that the derivative is calculated often enough to provide adequate damping for servo loop stability.

Systems with higher inertia can benefit from larger values of Td. Because the higher inertia means that the position error can not change quickly, it is acceptable to calculate the derivative less often. This means you can use a lower value of Kd, have the same effective amount of damping and the system will be smoother with less torque noise from the derivative term.

In higher inertia systems, using a Td of zero and therefore a larger value for Kd results in increased torque noise and motor heating without any improvement in system stability.

Velocity Feedback Gain

When an axis is configured with a secondary feedback encoder, you can use that encoder for velocity feedback. The velocity feedback gain (Kv) is used to scale this velocity feedback before it is added to the other components in the 16-bit DAC command output.



Note Velocity feedback is only available from encoders. It is not available from ADC channels.

It is possible to use Kv with only one feedback encoder. Map the encoder resource as both the primary and secondary resource for the axis.

Velocity feedback gain (Kv) is similar to derivative gain (Kd) except that it scales the velocity estimated from the secondary feedback resource only. The derivative gain scales the derivative of the position error, which is the difference between the instantaneous trajectory position and the primary feedback position. Like the Kd term, the velocity feedback derivative is calculated every derivative sample period and the contribution is updated every PID Sample Period.

The formula for calculating the velocity feedback contribution is as follows:

$$V_{out} = (20 \text{ V} / 2^{16}) K_v (\text{position}(t_1) - \text{position}(t_0))$$

where the time between t1 and t0 is the derivative sample period.

Velocity feedback is estimated through a combination of speed dependent algorithms. At high speeds, velocity is simply the change in position per sample. At low speeds, the estimator seamlessly transitions to a 1/T method that measures the time between encoder counts and then calculates the inverse. This method is used for smoother performance when estimating velocities less than one encoder count per sample derivative sample period.

Using K_v and a secondary feedback encoder creates a minor velocity feedback loop. This is very similar to the traditional analog servo control method using a tachometer and a velocity block amplifier and is commonly referred to as dual-loop feedback. Dual-loop feedback is most useful when the primary position sensor (encoder or analog transducer) is located on the end-effector for improved accuracy, and is separated from the motor by gears, ballscrews, belt drives, and/or other mechanical apparatus with potentially poor dynamics. In this case, it can be difficult to achieve a high performance, stable control system without using the minor loop velocity feedback from an encoder mounted directly on the back of the motor.

Typically, K_d is set to zero when K_v is used. However, FlexMotion allows you to use both K_v and K_d terms simultaneously for improved performance.



Note Operating with zero derivative gain (K_d) and either velocity feedback or a velocity block amplifier is often referred to as PIVff mode.

You can operate FlexMotion in PID mode, PIVff mode, or in a combination of both modes, by using K_d , K_v , or both.

Acceleration Feedforward

The acceleration feedforward gain (A_{ff}) determines the contribution in the 16-bit DAC command output that is directly proportional to the instantaneous trajectory acceleration. A_{ff} is used to minimize following error (position error) during acceleration and deceleration and can be changed at any time to tune the PID loop.

Using acceleration feedforward is an open-loop compensation technique and cannot affect the stability of the system. However, if you use too large a value of A_{ff} , following error during acceleration and deceleration can reverse, thus degrading rather than improving performance.

Velocity Feedforward

The velocity feedforward gain (V_{ff}) determines the contribution in the 16-bit DAC command output that is directly proportional to the instantaneous trajectory velocity. This value is used to minimize following error during the constant velocity portion of a move and can be changed at any time to tune the PID loop.

Using velocity feedforward is an open-loop compensation technique and cannot affect the stability of the system. However, if you use too large a value of V_{ff} , following error during the constant velocity portion can reverse, thus degrading rather than improving performance.

Velocity feedforward is typically used when operating in PIVff mode with either a velocity block amplifier or substantial amount of velocity feedback (K_v). In these cases, the uncompensated following error is directly proportional to the desired velocity. You can reduce this following error by applying velocity feedforward. Increasing the integral gain (K_i) will also reduce the following error during constant velocity but only at the expense of increased

following error during acceleration and deceleration and reduced system stability. For these reasons, increased K_i is not the recommended solution.

Velocity feedforward is rarely used when operating in PID mode with torque block amplifiers. In this case, because the following error is proportional to the torque required (not to the velocity), it is typically much smaller and velocity feedforward is not required.

Example

To load a K_p of 1,000 to an axis 5, call the *Load Single PID Parameter* function with the following parameters:

axis = 5

parameterType = NIMC_KP

PIDValue = 1,000

inputVector = 0xFF (Immediate)

flex_load_vel_tc_rs

Configure Velocity Filter

Format

status = flex_load_vel_tc_rs (**boardID**, **axis**, **filterTime**, **runStopThreshold**, **inputVector**)

Purpose

Loads the time constant for the velocity filter and sets the velocity threshold above which an axis will be considered running.

Parameters

Input

Name	Type	Description
boardID	u8	assigned by Measurement & Automation Explorer
axis	u8	axis to be controlled
filterTime	u16	filter time constant in Sample Periods
runStopThreshold	u16	Run/Stop threshold velocity in counts or steps/sample period
inputVector	u8	source of the data for this function

Parameter Discussion

axis is the axis to be controlled.

filterTime is the velocity filter time constant in update sample periods. The range for this parameter is 0 to 255 with a default value of 10 sample periods.

runStopThreshold is the Run/Stop threshold velocity in counts/sample period (servo and closed-loop stepper axes) or steps/sample period (open-loop stepper axes). The range for this parameter is 1(default) to 32,767 sample periods.

inputVector indicates the source of the data for this function. Available inputVectors include immediate (0xFF) or variable (0x01 through 0x78).

Using This Function

The *Configure Velocity Filter* function loads the time constant of the digital single-pole lowpass filter used to average the instantaneous axis velocity. It also sets the velocity threshold above which an axis will be considered running. Both parameters have time units of update sample periods and are affected by the update rate set in the *Enable Axes* function.

The velocity filter improves the resolution of the velocity reported in the *Read Velocity* and *Read Velocity in RPM* functions by averaging the measured counts or steps per sample over a programmable number of update sample periods. This filtering minimizes the quantization noise inherent in any discrete time velocity measurement of low speeds. Due to the aliasing effects of polling from the host computer, it is often not possible to remove quantization noise after velocity data has been gathered.



Note Velocity quantization noise is a measurement only phenomenon and does not affect the FlexMotion ability to accurately control velocity and position at low speeds.

This function also configures the Run/Stop status, which is used for move complete determination. This Run/Stop status uses the filtered velocity to minimize noise in this status. The Run/Stop threshold is programmable to account for a wide range of feedback device resolution and update sample periods and to allow the application to determine when an axis is going slow enough to be considered stopped. Refer to the *Read Trajectory Status* and *Configure Move Complete Criteria* functions for more information on the Run/Stop status.

The *Configure Velocity Filter* function is a status configuration function that is typically called for each axis prior to using the axis for motion control. Once the parameters are set, they remain in effect until changed. You can call this function at any time to tailor the status reporting functions as the application requires.

flex_set_stepper_loop_mode

Set Stepper Loop Mode

Format

status = flex_set_stepper_loop_mode (**boardID**, **axis**, **loopMode**)

Purpose

Sets a stepper axis to operate in either open or closed-loop mode.

Parameters

Input

Name	Type	Description
boardID	u8	assigned by Measurement & Automation Explorer
axis	u8	axis to be controlled
loopMode	u16	open or closed-loop mode of the stepper axis

Parameter Discussion

axis is the axis to be controlled.

loopMode sets the open or closed-loop mode for the stepper axis.

0 = open-loop (default)

1 = closed-loop

Using This Function

You can operate stepper axes in both open and closed-loop modes. In open-loop mode, the stepper axis controls the trajectory profile and generates steps but has no feedback from the motor or actuator to determine if the profile is followed correctly.

In closed-loop mode, the feedback position is constantly compared to the number of steps generated to see if the stepper motor is moving correctly. When the trajectory profile is complete, missing steps (if any) are made up with a pull-in move. If, at any time during the move, the difference between the instantaneous commanded position and the feedback position exceeds the programmed following error threshold, the axis is killed and motion stops.



Warning For proper closed-loop operation, the correct values for steps/rev and counts/rev must be loaded with the *Load Counts/Steps per Revolution* function. Incorrect counts to steps ratio can result in failure to reach the desired target position and erroneous closed-loop stepper operation.

To operate in closed-loop mode, a stepper axis must have a primary feedback resource (encoder or ADC channel) mapped to it prior to enabling the axis. Refer to the *Configure Axis Resources* functions for more information on feedback resources. You can operate an axis with a primary feedback resource in either open or closed-loop mode and you can switch the mode at any time. You can still read the position of the mapped feedback resource even when the axis is in open-loop mode.

Trajectory Control Functions

This chapter contains detailed descriptions of functions used to set up and control motion trajectories on the FlexMotion controller. It includes functions to load double-buffered trajectory parameters, read back instantaneous velocity, position and trajectory status, as well as functions to configure blending, gearing, and other advanced trajectory features. The functions are arranged alphabetically by function name.

Double-buffered parameters for axes and vector spaces include acceleration, deceleration, velocity, s-curve, operation mode, target position, and circular, helical, and spherical arc parameters. You can send these parameters to the controller at any time but do not take effect until you execute the next *Start Motion* or *Blend Motion* function. This double buffering allows you to set up moves ahead of time, synchronizing them with a single *Start Motion* or *Blend Motion* call.

Other trajectory functions allow you to configure the operation of trajectory generators and set status thresholds. These parameters include following error, blend factor, gear master, ratio and enable, position modulus, velocity threshold, torque limit, torque offset, and software limit positions. Unlike double-buffered parameters, if you change these parameters on the fly, they take effect immediately. Also in this category are functions to reset position to zero or another desired value and to force a velocity override.

During a move, you can read the instantaneous values of position, velocity, following error, and DAC output (torque). There are also functions to read the following trajectory status: move complete, profile complete, blend complete, motor off, following error trip, velocity threshold, and DAC limit status. These trajectory values and status are used for move sequencing, system coordination, and overall monitoring purposes.

Finally, FlexMotion offers a set of functions to acquire time-sampled position and velocity data into a large onboard buffer and then later read it out for analysis and display. These functions implement a digital oscilloscope that is useful during system setup, PID tuning, and general motion with data acquisition synchronization.

As a quick reference, a summary of the entire FlexMotion function API is in Appendix B, *FlexMotion Functions*.

flex_check_blend_complete_status

Check Blend Complete Status

Format

status = flex_check_blend_complete_status (**boardID**, **axisOrVectorSpace**, **axisOrVSMMap**, **blendComplete**)

Purpose

Checks the blend complete status for an axis, vector space, group of axes, or group of vector spaces.

Parameters

Input

Name	Type	Description
boardID	u8	assigned by Measurement & Automation Explorer
axisOrVectorSpace	u8	axis or vector space selector
axisOrVSMMap	u16	bitmap of axes or vector spaces to check

Output

Name	Type	Description
blendComplete	u16	the blend complete status

Parameter Discussion

axisOrVectorSpace can select an axis (1 through 6), vector space (0x11 through 0x13), multiple axes (0), or multiple vector spaces (0x10). When simultaneously checking multiple axes (0) or vector spaces (0x10), the **axisOrVSMMap** parameter indicates which axes or vector spaces to check.

axisOrVSMMap is the bitmap of axes or vector spaces to check. It is only required when multiple axes or vector spaces are selected with the **axisOrVectorSpace** parameter. Otherwise, this parameter is ignored.

When checking multiple axes (**axisOrVectorSpace** = 0):

D15	D14	D13	D12	D11	D10	D9	D8	D7	D6	D5	D4	D3	D2	D1	D0
0	0	0	0	0	0	0	0	0	Axis 6	Axis 5	Axis 4	Axis 3	Axis 2	Axis 1	0

For D1 through D6:

1 = Blend must be complete on specified axis

0 = Blend can be either complete or not complete on specified axis (don't care)

When checking multiple vector spaces (**axisOrVectorSpace** = 0x10):

D15	D14	D13	D12	D11	D10	D9	D8	D7	D6	D5	D4	D3	D2	D1	D0
0	0	0	0	0	0	0	0	0	0	0	0	VS 3	VS 2	VS 1	0

For D1 through D3:

1 = Blend must be complete on specified vector space

0 = Blend can be either complete or not complete on specified vector space (don't care)

To check for blend complete on a single axis or vector space, set the **axisOrVectorSpace** selector to the desired axis or vector space. The **axisOrVSMMap** bitmap is ignored.

To check for blend complete on multiple axes, the **axisOrVectorSpace** selector is set to 0 (zero) and the **axisOrVSMMap** bitmap defines the axes to be checked. They must all be blend complete for the **blendComplete** output to be true. Similarly, to check for blend complete on multiple vector spaces, the **axisOrVectorSpace** selector is set to 0x10 and the **axisOrVSMMap** bitmap defines the vector spaces to be checked.

blendComplete indicates whether or not the blend is complete on the axes or vector spaces specified.

1 = Blend complete

0 = Blend not complete

Using This Function

This utility function is built on top of the [Read Blend Status](#) function, and is provided for your programming convenience. Instead of decoding the output of the [Read Blend Status](#) function yourself, this function does that for you by comparing the axes or vector spaces specified in the **axisOrVectorSpace** and **axisOrVSMMap** input parameters with the blend complete status for the appropriate axes or vector spaces. The output is a single true/false value indicating whether or not the specified blend or blends are complete.

flex_check_move_complete_status

Check Move Complete Status

Format

status = flex_check_move_complete_status (**boardID**, **axisOrVectorSpace**, **axisOrVSMap**, **moveComplete**)

Purpose

Checks the move complete status for an axis, vector space, group of axes, or group of vector spaces.

Parameters

Input

Name	Type	Description
boardID	u8	assigned by Measurement & Automation Explorer
axisOrVectorSpace	u8	axis or vector space selector
axisOrVSMap	u16	bitmap of axes or vector spaces to check

Output

Name	Type	Description
moveComplete	u16	the move complete status

Parameter Discussion

axisOrVectorSpace can select an axis (1 through 6), vector space (0x11 through 0x13), multiple axes (0), or multiple vector spaces (0x10). When simultaneously checking multiple axes (0) or vector spaces (0x10), the **axisOrVSMap** parameter indicates which axes or vector spaces to check.

axisOrVSMap is the bitmap of axes or vector spaces to check. It is only required when multiple axes or vector spaces are selected with the **axisOrVectorSpace** parameter. Otherwise, this parameter is ignored.

When checking multiple axes (**axisOrVectorSpace** = 0):

D15	D14	D13	D12	D11	D10	D9	D8	D7	D6	D5	D4	D3	D2	D1	D0
0	0	0	0	0	0	0	0	0	Axis 6	Axis 5	Axis 4	Axis 3	Axis 2	Axis 1	0

For D1 through D6:

1 = Move must be complete on specified axis

0 = Move can be either complete or not complete on specified axis (don't care)

When checking multiple vector spaces (**axisOrVectorSpace** = 0x10):

D15	D14	D13	D12	D11	D10	D9	D8	D7	D6	D5	D4	D3	D2	D1	D0
0	0	0	0	0	0	0	0	0	0	0	0	VS 3	VS 2	VS 1	0

For D1 through D3:

1 = Move must be complete on specified vector space

0 = Move can be either complete or not complete on specified vector space (don't care)

To check for move complete on a single axis or vector space, set the **axisOrVectorSpace** selector to the desired axis or vector space. The **axisOrVSMap** bitmap is ignored.

To check for move complete on multiple axes, the **axisOrVectorSpace** selector is set to 0 (zero) and the **axisOrVSMap** bitmap defines the axes to be checked. They must all be move complete for the moveComplete output to be true. Similarly, to check for move complete on multiple vector spaces, the **axisOrVectorSpace** selector is set to 0x10 and the **axisOrVSMap** bitmap defines the vector spaces to be checked.

moveComplete indicates whether or not the move is complete on the axes or vector spaces specified.

1 = Move complete

0 = Move not complete

Using This Function

This utility function is built on top of the [Read Trajectory Status](#) function, and is provided for your programming convenience. Instead of decoding the output of the [Read Trajectory Status](#) function yourself, this function does that for you by comparing the axes or vector spaces specified in the **axisOrVectorSpace** and **axisOrVSMap** input parameters with the move complete status for the appropriate axes or vector spaces. The output is a single true/false value indicating whether or not the specified move or moves are complete.

For more information on move complete status, refer to the [Read Trajectory Status](#) and [Configure Move Complete Criteria](#) functions.

flex_load_acceleration

Load Acceleration/Deceleration

Format

status = flex_load_acceleration (**boardID**, **axisOrVectorSpace**, **accelerationType**, **acceleration**, **inputVector**)

Purpose

Loads the maximum acceleration and/or deceleration value for an axis or vector space.

Parameters

Input

Name	Type	Description
boardID	u8	assigned by Measurement & Automation Explorer
axisOrVectorSpace	u8	axis or vector space to be controlled
accelerationType	u16	selector for acceleration, deceleration or both
acceleration	u32	acceleration value in counts/s ² or steps/s ²
inputVector	u8	source of the data for this function

Parameter Discussion

axisOrVectorSpace is the axis or vector space to be controlled.

accelerationType is the selector for loading acceleration, deceleration or both acceleration and deceleration (default).

accelerationType Constant	accelerationType Value
NIMC_BOTH	0 (default)
NIMC_ACCELERATION	1
NIMC_DECELERATION	2

acceleration is the acceleration (and/or deceleration) value in counts/s² (servo axes) or steps/s² (stepper axes). The range for acceleration is 4,000 to 128,000,000 counts or steps/s².

inputVector indicates the source of the data for this function. Available inputVectors include immediate (0xFF) or variable (0x01 through 0x78).

Using This Function

The *Load Acceleration/Deceleration* function specifies the maximum rate of acceleration and/or deceleration for individual axes or vector spaces. When executed on a vector space, the value controls the vector acceleration (deceleration) along the vector move path.

You can use this function to load separate limits for acceleration and deceleration or to set them both to the same value with one call. These parameters are double-buffered so you can load them on the fly without affecting the move in process, and they will take effect on the next *Start Motion* or *Blend Motion* function. Once loaded, these parameters remain in effect for all subsequent motion profiles until re-loaded by this function. You do not need to load acceleration before each move unless you want to change it.

Acceleration defines how quickly the axis or axes come up to speed and is typically limited to avoid excessive stress on the motor, mechanical system and/or load. A separate, slower deceleration is useful in applications where gently coming to a stop is paramount.



Note You can also load acceleration and deceleration in motor rotations/s² by calling the *Load Accel/Decel in RPS/sec* function.

flex_load_follow_err

Load Following Error

Format

status = flex_load_follow_err (**boardID**, **axis**, **followingError**, **inputVector**)

Purpose

Loads the following error trip point.

Parameters

Input

Name	Type	Description
boardID	u8	assigned by Measurement & Automation Explorer
axis	u8	axis to be controlled
followingError	u16	following error trip point in counts
inputVector	u8	source of the data for this function

Parameter Discussion

axis is the axis to be controlled.

followingError is the following error trip point in encoder counts. If the following error exceeds this value, the axis will be automatically killed. The range is 0 to 32,767 with a default of 32,767 counts. Loading zero (0) is a special case that disables the following error trip functionality.

inputVector indicates the source of the data for this function. Available inputVectors include immediate (0xFF) or variable (0x01 through 0x78).

Using This Function

The *Load Following Error* function sets the maximum allowable following error. Following error is the difference between the instantaneous commanded trajectory position and the feedback position. If the absolute value of this difference exceeds the trip point, an internal kill stop is issued and the axis is disabled.

This function is a safety feature used to protect the motion hardware and associated system components from damage when the position error gets excessive due to friction, binding, or a completely stalled motor. It will also protect you in case you load unobtainable values for velocity and/or acceleration.

This feature is available on all servo and closed-loop stepper axes. It has no effect on stepper axes running in open-loop mode. You can completely disable the following error feature by loading a zero (0) value.



Caution Following error should not be disabled unless your application absolutely requires operating with greater than 32,787 counts of error.

You can monitor following error status with the *Read Trajectory Status* or *Read per Axis Status* functions. A following error trip always sets the Motor Off status. You can further diagnose the cause of the trip by checking the torque limit status with the *Read DAC Limit Status* function.

In general, a following error trip is considered normal operation and does not generate an error. There are a few cases where an unexpected following error trip will generate a modal error: during Find Home or Find Index and while executing a stored program. For information about errors and error handling, refer to the *Errors and Error Handling* section in Chapter 4, *Software Overview*.

flex_load_rpm

Load Velocity in RPM

Format

status = flex_load_rpm (boardID, axisOrVectorSpace, RPM, inputVector)

Purpose

Loads velocity for an axis or vector space in RPM.

Parameters

Input

Name	Type	Description
boardID	u8	assigned by Measurement & Automation Explorer
axisOrVectorSpace	u8	axis or vector space to be controlled
RPM	f64	velocity in RPM
inputVector	u8	source of the data for this function

Parameter Discussion

axisOrVectorSpace is the axis or vector space to be controlled.

RPM is the double precision floating point velocity value in RPM. The **RPM** range depends upon the motor counts or steps per revolution and the trajectory update rate. Refer to the [Trajectory Parameters](#) section in Chapter 4, [Software Overview](#), for more information on velocity and acceleration units and their dependency on trajectory update rate.

inputVector indicates the source of the data for this function. Available inputVectors include immediate (0xFF) or variable (0x01 through 0x78).

Using This Function

The [Load Velocity in RPM](#) function specifies the maximum trajectory velocity for individual axes or vector spaces. When executed on a vector space, the value controls the vector velocity along the vector move path. For velocity control applications, the sign of the loaded velocity specifies the move direction. This function requires previously loaded values of either counts per revolution (for servo axes) or steps per revolution (for stepper axes) to operate correctly.

RPM is double-buffered so you can load it on the fly without affecting the move in process, and it will take effect on the next *Start Motion* or *Blend Motion* function. Once loaded, this parameter remains in effect for all subsequent motion profiles until re-loaded by this function. You do not need to load velocity before each move unless you want to change it.



Note The velocity loaded with this function is the maximum move velocity. Actual velocity attainable is determined by many factors including PID tuning, length of move, acceleration and deceleration values, and physical constraints of the amplifier/motor/mechanical system.

You can also load velocity in counts/s or steps/s by calling the *Load Velocity* function.

flex_load_rpsps

Load Accel/Decel in RPS/sec

Format

status = flex_load_rpsps (boardID, axisOrVectorSpace, accelerationType, RPSPS, inputVector)

Purpose

Loads the maximum acceleration and/or deceleration value for an axis or vector space in RPS/sec.

Parameters

Input

Name	Type	Description
boardID	u8	assigned by Measurement & Automation Explorer
axisOrVectorSpace	u8	axis or vector space to be controlled
accelerationType	u16	selector for acceleration, deceleration or both
RPSPS	f64	acceleration value in revolutions/s/s
inputVector	u8	source of the data for this function

Parameter Discussion

axisOrVectorSpace is the axis or vector space to be controlled.

accelerationType is the selector for loading acceleration, deceleration, or both acceleration and deceleration (default).

accelerationType Constant	accelerationType Value
NIMC_BOTH	0 (default)
NIMC_ACCELERATION	1
NIMC_DECELERATION	2

acceleration is the double precision floating point acceleration (and/or deceleration) value in motor revolutions/s/s (RPS/s). The range for acceleration in RPS/s depends upon the motor counts or steps per revolution and the trajectory update rate. Refer to the [Trajectory Parameters](#) section in Chapter 4, [Software Overview](#), for more information on velocity and acceleration units and their dependency on trajectory update rate.

inputVector indicates the source of the data for this function. Available inputVectors include immediate (0xFF) or variable (0x01 through 0x78).

Using This Function

The *Load Accel/Decel in RPS/sec* function specifies the maximum rate of acceleration and/or deceleration for individual axes or vector spaces in revolutions/s/s. When executed on a vector space, the value controls the vector acceleration (deceleration) along the vector move path. This function requires previously loaded values of either counts per revolution (for servo axes) or steps per revolution (for stepper axes) to operate correctly.

You can use this function to load separate limits for acceleration and deceleration or to set them both to the same value with one call. These parameters are double-buffered so you can load them on the fly without affecting the move in process, and they will take effect on the next *Start Motion* or *Blend Motion* function. Once loaded, these parameters remain in effect for all subsequent motion profiles until re-loaded by this function. You do not need to load acceleration before each move unless you want to change it.

Acceleration defines how quickly the axis or axes come up to speed and is typically limited to avoid excessive stress on the motor, mechanical system, and/or load. A separate, slower deceleration is useful in applications where gently coming to a stop is paramount.



Note You can also load acceleration and deceleration in counts/s² or steps/s² by calling the *Load Acceleration/Deceleration* function.

flex_load_target_pos

Load Target Position

Format

status = flex_load_target_pos (**boardID**, **axis**, **targetPosition**, **inputVector**)

Purpose

Loads the target position for the next axis move.

Parameters

Input

Name	Type	Description
boardID	u8	assigned by Measurement & Automation Explorer
axis	u8	axis to be controlled
targetPosition	i32	target position in counts or steps
inputVector	u8	source of the data for this function

Parameter Discussion

axis is the axis to be controlled.

targetPosition is the desired target position for the next axis move in counts (servo axes) or steps (stepper axes). Target positions can be anywhere within the 32-bit position range, $-(2^{31})$ to $+(2^{31}-1)$. The default value for target position is zero (0).



Caution Any single move is limited to $\pm(2^{31}-1)$ counts or steps. An error will be generated if you exceed this limit by loading a target position too far from the current axis position.

inputVector indicates the source of the data for this function. Available inputVectors include immediate (0xFF) or variable (0x01 through 0x78).

Using This Function

The *Load Target Position* function loads a target position to the axis specified. Target positions can be for single axis moves, multi-axis coordinated moves, or vector space moves. Position values indicate the desired end location and direction of motion (target position).



Note See the *Load Vector Space Position* function for an easy way to load up to three target positions for a vector space in one call.

Target position is double-buffered so you can load it on the fly without affecting the move in process, and it will take effect on the next *Start Motion* or *Blend Motion* function. When the target position is loaded, it is interpreted as either an absolute target position, a relative target position, a target position relative to the last captured position or with the effect of a position modulus, depending on the mode set with the *Set Operation Mode* function.

Once you execute the start or blend, the axis or axes will follow the programmed trajectory and end up at the absolute, relative, or modulo target position.

flex_load_velocity

Load Velocity

Format

status = flex_load_velocity (boardID, axisOrVectorSpace, velocity, inputVector)

Purpose

Loads the maximum velocity for an axis or vector space.

Parameters

Input

Name	Type	Description
boardID	u8	assigned by Measurement & Automation Explorer
axisOrVectorSpace	u8	axis or vector space to be controlled
velocity	i32	velocity in counts/s or steps/s
inputVector	u8	source of the data for this function

Parameter Discussion

axisOrVectorSpace is the axis or vector space to be controlled.

velocity is the target or maximum slewing velocity in counts/s (servo axes) or steps/s (stepper axes). For servo axes, the velocity range is from ± 1 to $\pm 16,000,000$ counts/s. For stepper axes it is ± 1 to $\pm 1,500,000$ steps/s. The upper range limits are the physical limitations of the encoder inputs and stepper generator outputs.



Note It is possible to load a velocity slower than 1 count or step per second by using the *Load Velocity in RPM* function.

Refer to the *Trajectory Parameters* section in Chapter 4, *Software Overview*, for more information on velocity and acceleration units and their dependency on trajectory update rate.

inputVector indicates the source of the data for this function. Available inputVectors include immediate (0xFF) or variable (0x01 through 0x78).

Using This Function

The *Load Velocity* function specifies the maximum trajectory velocity for individual axes or vector spaces. When executed on a vector space, the value controls the vector velocity along the vector move path. For velocity control applications, the sign of the loaded velocity specifies the move direction.

Velocity is a double-buffered parameter so you can load it on the fly without affecting the move in process, and it will take effect on the next *Start Motion* or *Blend Motion* function. Once loaded, this parameter remains in effect for all subsequent motion profiles until re-loaded by this function. You do not need to load velocity before each move unless you want to change it.



Note The velocity loaded with this function is the maximum move velocity. Actual velocity attainable is determined by many factors including PID tuning, length of move, acceleration and deceleration values, and physical constraints of the amplifier/motor/mechanical system.

flex_load_vs_pos

Load Vector Space Position

Format

status = flex_load_vs_pos (boardID, vectorSpace, xPosition, yPosition, zPosition, inputVector)

Purpose

Loads the axis target positions for the next vector space move.

Parameters

Input

Name	Type	Description
boardID	u8	assigned by Measurement & Automation Explorer
vectorSpace	u8	vector space to be controlled
xPosition	i32	x axis target position in counts or steps
yPosition	i32	y axis target position in counts or steps
zPosition	i32	z axis target position in counts or steps
inputVector	u8	source of the data for this function

Parameter Discussion

vectorSpace is the vector space to be controlled.

xPosition, **yPosition**, and **zPosition** are the desired axis target positions for the next vector space move in counts (servo axes) or steps (stepper axes). Target positions can be anywhere within the 32-bit position range, $-(2^{31})$ to $+(2^{31}-1)$. The default value for position is zero (0).



Caution Any single move is limited to $\pm(2^{31}-1)$ counts or steps on an axis. An error will be generated if you exceed this limit by loading target position too far from the current axis positions.

inputVector indicates the source of the data for this function. Available inputVectors include immediate (0xFF) or variable (0x01 through 0x78).

Using This Function

The *Load Vector Space Position* function loads up to three axis target positions for the vector space specified. This function is identical to calling the *Load Target Position* function up to three times, once per each axis in the vector space. Position values indicate the desired end location and direction of motion (target position).

Target positions are double-buffered so you can load them on the fly without affecting the move in process, and they will take effect on the next *Start Motion* or *Blend Motion* function. When the target positions are loaded, they are interpreted as either absolute target positions, relative target positions, target positions relative to the last captured positions or with the effect of a position modulus, depending on the mode set with the *Set Operation Mode* function.

Once you execute the start or blend, the axes in the vector space will follow the programmed trajectory and end up at the absolute, relative, or modulo target positions.



Note If the vector space contains less than three axes, the extra target position values are ignored.

flex_read_axis_status and flex_read_axis_status_rtn

Read per Axis Status

Format

status = flex_read_axis_status (boardID, axis, returnVector)

status = flex_read_axis_status_rtn (boardID, axis, axisStatus)

Purpose

Reads the motion status on a per-axis basis.

Parameters

Input

Name	Type	Description
boardID	u8	assigned by Measurement & Automation Explorer
axis	u8	axis to read
returnVector	u8	destination for the return data

Output

Name	Type	Description
axisStatus	u16	bitmap of per-axis status

Parameter Discussion

axis is the axis to read.

returnVector indicates the desired destination for the return data generated by this function. Available returnVectors include return data to the host (0xFF), return data to a variable (0x01 through 0x78), and don't return data (0).



Note The suffix **_rtn** on the function indicates that the data should be returned to the host. When this calling convention is used, no **returnVector** is required.

axisStatus is a bitmap of motion status for the axis.

D15	D14	D13	D12	D11	D10	D9	D8	D7	D6	D5	D4	D3	D2	D1	D0
MC	BC	Dir	HSC	IF	HF	BP	VT	XXX	S/W Limit	Home	Limit	FE	MOff	PC	R/S

D0 Run/Stop Status (R/S):

1 = Axis running

0 = Axis stopped

D1 Profile Complete (PC):

1 = Profile complete

0 = Profile generation in process

D2 Motor Off (Moff):

1 = Motor off (killed)

0 = Motor on

D3 Following Error (FE):

1 = Axis tripped on following error

0 = Ok

D4 Limit Input (Limit):

1 = Forward or reverse limit input active

0 = Neither limit active

D5 Home Input (Home):

1 = Home input active

0 = Home input not active

D6 Software Limit (S/W Limit):

1 = Forward or reverse software limit reached

0 = Neither software limit reached

D7 Reserved

D8 Velocity Threshold (VT):

1 = Velocity above threshold

0 = Velocity below threshold

D9 Breakpoint (BP):

- 1 = Breakpoint occurred
- 0 = Breakpoint pending or disabled

D10 Home Found (HF):

- 1 = Home found during last Find Home
- 0 = Find Home sequence in process or home not found

D11 Index Found (IF):

- 1 = Encoder Index found during last Find Index
- 0 = Find Index sequence in process or index not found

D12 High Speed Capture (HSC):

- 1 = High speed capture occurred
- 0 = High speed capture pending

D13 Direction (Dir):

- 1 = Reverse
- 0 = Forward

D14 Blend Complete (BC):

- 1 = Blend complete
- 0 = Blend pending

D15 Move Complete (MC):

- 1 = Move complete
- 0 = Move not complete

Using This Function

The *Read per Axis Status* function returns the trajectory and motion I/O status for the specified axis. It also returns the success or failure status of the most recent *Find Home* and *Find Index* sequences.



Note You can also read individual item status in a multi-axis format with FlexMotion functions like *Read Limit Status*, *Read Trajectory Status*, and so on.

Example

Read per Axis Status is called on axis 4 and the function returns **axisStatus** = 0xBE02.

The returned value 0xBE02 corresponds to the following bitmap.

D15	D14	D13	D12	D11	D10	D9	D8	D7	D6	D5	D4	D3	D2	D1	D0
MC	BC	Dir	HSC	IF	HF	BP	VT	XXX	S/W Limit	Home	Limit	FE	MOff	PC	R/S
1	0	1	1	1	1	1	0	0	0	0	0	0	0	1	0

The trajectory profile is complete, the move is complete, the motor is not running but it is enabled, there was no following error trip, no active limits, home or software limits, a blended move is pending, there was a position breakpoint, velocity is below the threshold, the last find home and find index completed successfully, there was a high-speed position capture, and the last move was in the reverse direction.

flex_read_blend_status and flex_read_blend_status_rtn

Read Blend Status

Format

status = flex_read_blend_status (boardID, axisOrVectorSpace, returnVector)

status = flex_read_blend_status_rtn (boardID, axisOrVectorSpace, blendStatus)

Purpose

Reads the Blend Complete status for all axes or vector spaces.

Parameters

Input

Name	Type	Description
boardID	u8	assigned by Measurement & Automation Explorer
axisOrVectorSpace	u8	axis or vector space selector
returnVector	u8	destination for the return data

Output

Name	Type	Description
blendStatus	u16	bitmap of blend complete status for all axes or vector spaces

Parameter Discussion

axisOrVectorSpace is the axis or vector space selector. For multi-axis status, use 0 (zero). For multi-vector space status, use 0x10.

returnVector indicates the desired destination for the return data generated by this function. Available returnVectors include return data to the host (0xFF), return data to a variable (0x01 through 0x78), and don't return data (0).



Note The suffix `_rtn` on the function indicates that the data should be returned to the host. When this calling convention is used, no **returnVector** is required.

blendStatus is a bitmap of blend complete status for all axes or all vector spaces.

When reading blend status for axes (**axisOrVectorSpace = 0**):

D15	D14	D13	D12	D11	D10	D9	D8	D7	D6	D5	D4	D3	D2	D1	D0
XXX	XXX	XXX	XXX	XXX	XXX	XXX	XXX	XXX	Axis 6	Axis 5	Axis 4	Axis 3	Axis 2	Axis 1	XXX

D1 through D6:

1 = Blend complete on axis

0 = Blend pending

When reading blend status for vector spaces (**axisOrVectorSpace = 0x10**):

D15	D14	D13	D12	D11	D10	D9	D8	D7	D6	D5	D4	D3	D2	D1	D0
XXX	XXX	XXX	XXX	XXX	XXX	XXX	XXX	XXX	XXX	XXX	XXX	VS3	VS2	VS1	XXX

D1 through D3:

1 = Blend complete on vector space

0 = Blend pending

Using This Function

Blending smoothly combines two move segments on an axis, axes, or vector space(s). When continuously blending move segments into each other, it is necessary to wait until the blend is complete between the previous two moves before you load the trajectory parameters for the next move to be blended. The status information returned by the [Read Blend Status](#) function indicates that the previous blend is complete and the axis, axes, or vector space(s) are ready to receive the next blend move trajectory data.



Note Attempting to execute a [Blend Motion](#) function before the previous blend is complete on the axes involved will generate a modal error. For information about errors and error handling, refer to Chapter 4, [Software Overview](#).

Example

While blending linearly interpolated moves in a 2D vector space, you call the *Read Blend Status* function with **axisOrVectorSpace** = 0x10 to select vector space status. If the blend on vector space 1 is still pending, this function will return **blendStatus** = 0x000C, which corresponds to the following bitmap.

D15	D14	D13	D12	D11	D10	D9	D8	D7	D6	D5	D4	D3	D2	D1	D0
XXX	XXX	XXX	XXX	XXX	XXX	XXX	XXX	XXX	XXX	XXX	XXX	VS3	VS2	VS1	XXX
0	0	0	0	0	0	0	0	0	0	0	0	1	1	0	0

The blend is complete (1) on vector spaces 2 and 3 (or they do not exist), but the blend is still pending (0) on vector space 1.

For your programming convenience, two utility functions—*Check Blend Complete Status* and *Wait for Blend Complete*—are provided, which allow you to specify an axis, vector space, group of axes, or group of vector spaces, and find out if a blend is complete, or wait until a blend is complete. These functions return a simple true/false value indicating whether or not a blend is complete.

flex_read_follow_err and flex_read_follow_err_rtn

Read Following Error

Format

status = flex_read_follow_err (boardID, axisOrVectorSpace, returnVector)

status = flex_read_follow_err_rtn (boardID, axisOrVectorSpace, followingError)

Purpose

Reads the instantaneous following error for an axis or vector space.

Parameters

Input

Name	Type	Description
boardID	u8	assigned by Measurement & Automation Explorer
axisOrVectorSpace	u8	axis or vector space to be read
returnVector	u8	destination for the return data

Output

Name	Type	Description
followingError	i16	instantaneous following error for an axis or vector space in counts

Parameter Discussion

axisOrVectorSpace is the axis or vector space to be read.

returnVector indicates the desired destination for the return data generated by this function. Available returnVectors include return data to the host (0xFF), return data to a variable (0x01 through 0x78), and don't return data (0).



Note The suffix **_rtn** on the function indicates that the data should be returned to the host. When this calling convention is used, no **returnVector** is required.

followingError is the instantaneous difference between the commanded trajectory position and the actual feedback position in counts.

Using This Function

The *Read Following Error* function returns the instantaneous following error for the axis or vector space specified. For vector spaces, following error is the root-mean-square of the following errors for the individual axes that make up the vector space.



Note Following error limit cannot be set for a vector space, you must set a following error limit for each axis individually.

flex_read_mcs_rtn

Read Move Complete Status

Format

status = flex_read_mcs_status_rtn (boardID, moveCompleteStatus)

Purpose

Reads the Move Complete Status register.

Parameters

Input

Name	Type	Description
boardID	u8	assigned by Measurement & Automation Explorer

Output

Name	Type	Description
moveCompleteStatus	u16	bitmap of Move Complete Status for all axes

Parameter Discussion

moveCompleteStatus is a bitmap of Move Complete Status for all six axes. The bitmap also includes the state of the three User Status bits.

D15	D14	D13	D12	D11	D10	D9	D8	D7	D6	D5	D4	D3	D2	D1	D0
Sts15	Sts14	Sts13	XXX	XXX	XXX	XXX	XXX	XXX	MC 6	MC 5	MC 4	MC 3	MC 2	MC 1	XXX

D1 through D6 Move Complete (MC):

1 = Move is complete

0 = Axis is moving

D13 through D15 User Status (Sts):

1 = True

0 = False

Using This Function

The *Read Move Complete Status* function performs a direct read of the Move Complete Status (MCS) register on the FlexMotion controller. Because a register read is virtually instantaneous and does not effect communication processing or other FlexMotion operations, you can call this function repetitively to get the most up to date status for the axes.

Move Complete Status is configurable individually for each axis with the *Configure Move Complete Criteria* function. The criteria for considering motion to be complete include Profile Complete, Run/Stop, In Position, Settling time delay, and so on.



Note Reading the MCS register immediately after calling the *Start Motion* function might not return the status you expected. The *Start Motion* can still be buffered in the communications FIFO when the instantaneous read of the MCS occurs.

This function also returns the state of the User Status bits. You can set and reset these three bits during onboard program execution as general-purpose flags to the host computer. Refer to the *Set User Status MOMO* function for more information.



Note When the FlexMotion controller is in the Power-Up state, the MCS register contains a power-up code that describes why the controller is in the Power-Up state. For a list of these power-up codes, refer to the *Clear Power Up Status* function.

flex_read_pos and flex_read_pos_rtn

Read Position

Format

status = flex_read_pos (boardID, axis, returnVector)

status = flex_read_pos_rtn (boardID, axis, position)

Purpose

Reads the position of an axis.

Parameters

Input

Name	Type	Description
boardID	u8	assigned by Measurement & Automation Explorer
axis	u8	axis to be read
returnVector	u8	destination for the return data

Output

Name	Type	Description
position	i32	axis position in counts (servo) or steps (stepper)

Parameter Discussion

axis is the axis to be read.

returnVector indicates the desired destination for the return data generated by this function. Available returnVectors include return data to the host (0xFF), return data to a variable (0x01 through 0x78), and don't return data (0).



Note The suffix `_rtn` on the function indicates that the data should be returned to the host. When this calling convention is used, no **returnVector** is required.

position is the axis position in quadrature counts (for servo axes) or steps (for stepper axes).

Using This Function

The *Read Position* function returns the instantaneous position of the specified axis. For servo axes, it returns the primary feedback position in counts. For open-loop stepper axes, it returns the number of steps generated. For closed-loop stepper axes, it converts the primary feedback position from counts to steps and then returns the value in steps. Closed-loop stepper axes require you to correctly load values of steps per revolution and counts per revolution to function correctly.



Note For closed-loop axes, this function always returns the position of the primary feedback resource.

See the *Read Vector Space Position* function for an easy way to read up to three axis positions for a vector space in one call.

flex_read_rpm and flex_read_rpm_rtn

Read Velocity in RPM

Format

status = flex_read_rpm (boardID, axisOrVectorSpace, returnVector)

status = flex_read_rpm_rtn (boardID, axisOrVectorSpace, RPM)

Purpose

Reads the filtered velocity of an axis or vector space in RPM.

Parameters

Input

Name	Type	Description
boardID	u8	assigned by Measurement & Automation Explorer
axisOrVectorSpace	u8	axis or vector space to be read
returnVector	u8	destination for the return data

Output

Name	Type	Description
RPM	f64	filtered velocity in RPM

Parameter Discussion

axisOrVectorSpace is the axis or vector space to be read.

returnVector indicates the desired destination for the return data generated by this function. Available returnVectors include return data to the host (0xFF), return data to a variable (0x01 through 0x78), and don't return data (0).



Note The suffix **_rtn** on the function indicates that the data should be returned to the host. When this calling convention is used, no **returnVector** is required.

RPM is the filtered velocity value in RPM expressed as a double-precision floating point number. For vector spaces, RPM is the filtered vector velocity for the vector move. The sign of RPM indicates direction of motion.

Using This Function

The *Read Velocity in RPM* function returns the axis or vector space filtered velocity in RPM. To minimize the quantization effects of any sampled data system, the instantaneous measured velocity is averaged by a single-pole low pass filter and converted to RPM before being returned. The time constant for this filter is programmable with the *Configure Velocity Filter* function.

For vector spaces, this function returns vector velocity, the root-mean-square of the filtered velocities of the individual axes that make up the vector space.



Note This function requires previously loaded values of either counts per revolution (for servo axes) or steps per revolution (for stepper axes) to operate correctly.

flex_read_trajectory_status and flex_read_trajectory_status_rtn

Read Trajectory Status

Format

`status = flex_read_trajectory_status (boardID, axisOrVectorSpace, statusType, returnVector)`
`status = flex_read_trajectory_status_rtn (boardID, axisOrVectorSpace, statusType, status)`

Purpose

Reads the selected motion trajectory status of all axes or vector spaces.

Parameters

Input

Name	Type	Description
<code>boardID</code>	u8	assigned by Measurement & Automation Explorer
<code>axisOrVectorSpace</code>	u8	axis or vector space selector
<code>statusType</code>	u16	status selector
<code>returnVector</code>	u8	destination for the return data

Output

Name	Type	Description
<code>status</code>	u16	bitmap of selected status for all axes

Parameter Discussion

`axisOrVectorSpace` is the axis or vector space selector. For multi-axis status, use 0 (zero). For multi-vector space status, use 0x10.

`statusType` is the selector for the type of trajectory status to be read.

<code>statusType</code> Constant	<code>statusType</code> Value	<code>axisOrVectorSpace</code> Value
<code>NIMC_RUN_STOP_STATUS</code>	0	0 only
<code>NIMC_MOTOR_OFF_STATUS</code>	1	0 only
<code>NIMC_VELOCITY_THRESHOLD_STATUS</code>	2	0 only
<code>NIMC_MOVE_COMPLETE_STATUS</code>	3	0 or 0x10

status is the bitmap of multi-axis or vector space status.

D15	D14	D13	D12	D11	D10	D9	D8	D7	D6	D5	D4	D3	D2	D1	D0
XXX	XXX	XXX	XXX	XXX	XXX	XXX	XXX	XXX	Axis 6	Axis 5	Axis 4	Axis 3	Axis 2	Axis 1	XXX

D15	D14	D13	D12	D11	D10	D9	D8	D7	D6	D5	D4	D3	D2	D1	D0
XXX	XXX	XXX	XXX	XXX	XXX	XXX	XXX	XXX	XXX	XXX	XXX	VS 3	VS 2	VS 1	XXX

D1 through D6 (axes) or D1 through D3 (vector spaces):

For NIMC_RUN_STOP_STATUS:

- 1 = Axis running
- 0 = Axis stopped

For NIMC_MOTOR_OFF_STATUS:

- 1 = Axis off
- 0 = Axis on

For NIMC_VELOCITY_THRESHOLD_STATUS:

- 1 = Velocity above threshold
- 0 = Velocity below threshold

For NIMC_MOVE_COMPLETE_STATUS:

- 1 = Move complete
- 0 = Move not complete

returnVector indicates the desired destination for the return data generated by this function. Available returnVectors include return data to the host (0xFF), return data to a variable (0x01 through 0x78), and don't return data (0).



Note The suffix `_rtn` on the function indicates that the data should be returned to the host. When this calling convention is used, no **returnVector** is required.

Using This Function

The *Read Trajectory Status* function returns a multi-axis status bitmap of the status type selected. You can select one of the following three trajectory status types:

NIMC_RUN_STOP_STATUS

Run/Stop status is derived from a change in position per update sample period. The axis is considered to be running when the change in position per sample period exceeds the Run/Stop threshold set with the *Configure Velocity Filter* function.

NIMC_MOTOR_OFF_STATUS

A motor can be Off for two reasons. Either a kill stop was executed or the following error trip point was exceeded. A Motor Off condition also means that a properly configured inhibit output is active. See the *Configure Inhibit Outputs* function for more information.

NIMC_VELOCITY_THRESHOLD_STATUS

The Velocity Threshold status indicates whether the axis velocity is above (True) or below (False) the programmed velocity threshold. For information about setting and using a velocity threshold, see the *Load Velocity Threshold* function.

NIMC_MOVE_COMPLETE_STATUS

The Move Complete status indicates whether an axis or vector space is in the move complete state, which is the default when an axis or vector space is idle. While a move is in progress, the move complete status will be false. For a move to be complete on a vector space, the move complete status must be true on all axes in the vector space.

During a vector space move, if one axis in a vector space trips out on a following error, that axis is killed, and the move complete status remains false. The other axes in the vector space decelerate to a stop, and the move complete status is true. For the vector space as a whole, the move complete status is false, because the move did not complete properly.

Use the *Configure Move Complete Criteria* function to change the conditions that cause a move to be evaluated as complete. For example, by changing the move complete criteria to be profile complete (default) OR motor off, the previous situation would result in a true move complete status when one of the axes in the vector space tripped out on a following error.



Note You can get all four trajectory statuses for a single axis by calling the *Read per Axis Status* function.

Example

To get Motor Off status, call the *Read Trajectory Status* function with **axisOrVectorSpace** = 0 and **statusType** = NIMC_MOTOR_OFF_STATUS. Assume the returned **status** = 0x0062. This corresponds to the following bitmap.

D15	D14	D13	D12	D11	D10	D9	D8	D7	D6	D5	D4	D3	D2	D1	D0
XXX	XXX	XXX	XXX	XXX	XXX	XXX	XXX	XXX	Axis 6	Axis 5	Axis 4	Axis 3	Axis 2	Axis 1	XXX
0	0	0	0	0	0	0	0	0	1	1	0	0	0	1	0

Axes 1, 5, 6 are Off.

For your programming convenience, two utility functions—*Check Move Complete Status* and *Wait for Move Complete*—are provided, which allow you to specify an axis, vector space, group of axes, or group of vector spaces, and find out if a move is complete, or wait until a move is complete. These functions return a simple true/false value indicating whether or not a move is complete.

flex_read_velocity and flex_read_velocity_rtn

Read Velocity

Format

status = flex_read_velocity (boardID, axisOrVectorSpace, returnVector)

status = flex_read_velocity_rtn (boardID, axisOrVectorSpace, velocity)

Purpose

Reads the filtered velocity of an axis or vector space.

Parameters

Input

Name	Type	Description
boardID	u8	assigned by Measurement & Automation Explorer
axisOrVectorSpace	u8	axis or vector space to be read
returnVector	u8	destination for the return data

Output

Name	Type	Description
velocity	i32	axis or vector space filtered velocity in counts/s (servo) or steps/s (stepper)

Parameter Discussion

axisOrVectorSpace is the axis or vector space to be read.

returnVector indicates the desired destination for the return data generated by this function. Available returnVectors include return data to the host (0xFF), return data to a variable (0x01 through 0x78), and don't return data (0).



Note The suffix `_rtn` on the function indicates that the data should be returned to the host. When this calling convention is used, no **returnVector** is required.

velocity is filtered velocity in counts/s (for servo axes) or steps/s (for stepper axes). For vector spaces, velocity is the filtered vector velocity for the vector move. The sign of velocity indicates direction of motion.

Using This Function

The *Read Velocity* function returns the axis or vector space filtered velocity in counts/s or steps/s. To minimize the quantization effects of any sampled data system, the instantaneous measured velocity is averaged by a single-pole low pass filter before being returned. The time constant for this filter is programmable with the *Configure Velocity Filter* function.

For vector spaces, this function returns vector velocity, the root-mean-square of the filtered velocities of the individual axes that make up the vector space.



Note You can also read velocity in RPM by calling the *Read Velocity in RPM* function.

flex_read_vs_pos and flex_read_vs_pos_rtn

Read Vector Space Position

Format

status = flex_read_vs_pos (boardID, vectorSpace, returnVector)

status = flex_read_vs_pos_rtn (boardID, vectorSpace, xPosition, yPosition, zPosition)

Purpose

Reads the position of all axes in a vector space.

Parameters

Input

Name	Type	Description
boardID	u8	assigned by Measurement & Automation Explorer
vectorSpace	u8	vector space to be read
returnVector	u8	destination for the return data

Output

Name	Type	Description
xPosition	i32	x axis position in counts or steps
yPosition	i32	y axis position in counts or steps
zPosition	i32	z axis position in counts or steps

Parameter Discussion

vectorSpace is the vector space to be read.

returnVector indicates the desired destination for the return data generated by this function. Available returnVectors include return data to the host (0xFF), return data to a variable (0x01 through 0x78), and don't return data (0).



Note The suffix `_rtn` on the function indicates that the data should be returned to the host. When this calling convention is used, no **returnVector** is required.

xPosition, **yPosition**, and **zPosition** are the positions in quadrature counts (for servo axes) or steps (for stepper axes) of the three axes in the vector space. For vector spaces with less than three axes, zero (0) is returned on the unused axes.

Using This Function

The *Read Vector Space Position* function returns the instantaneous positions of the axes in the specified vector space. For servo axes, it returns the primary feedback position in counts. For open-loop stepper axes, it returns the number of steps generated. For closed-loop stepper axes, it converts the primary feedback position from counts to steps and then returns the value in steps. Closed-loop stepper axes require correctly loaded values of steps per revolution and counts per revolution to function correctly.



Note For closed-loop axes, this function always returns the position of the primary feedback resource.

flex_reset_pos

Reset Position

Format

status = flex_reset_pos (boardID, axis, position1, position2, inputVector)

Purpose

Resets an axis position to a desired value.

Parameters

Input

Name	Type	Description
boardID	u8	assigned by Measurement & Automation Explorer
axis	u8	axis to be controlled
position1	i32	reset value for axis and primary feedback resource
position2	i32	reset value for secondary feedback resource
inputVector	u8	source of the data for this function

Parameter Discussion

axis is the axis to be controlled.

position1 is the reset value for the axis and its associated primary feedback resource. You can reset position to any value in the total position range of $-(2^{31})$ to $+(2^{31}-1)$.

position2 is the reset value for the optional secondary feedback resource. You can reset position to any value in the total position range of $-(2^{31})$ to $+(2^{31}-1)$.



Note For stepper closed-loop configurations, where the encoder counts per revolution is greater than the steps per revolution, the range of the position parameters is reduced to $-(2^{31})/\text{counts}$ or steps to $(2^{31}-1)/\text{counts}$ or steps.

inputVector indicates the source of the data for this function. Available inputVectors include immediate (0xFF) or variable (0x01 through 0x78).

Using This Function

The *Reset Position* function resets the axis position, the associated primary feedback position, and the optional secondary feedback position. You can reset position to zero or any value in the 32-bit position range. You can reset the secondary feedback to the same value as the axis and primary feedback or you can reset it to a different value. If a secondary feedback resource is not in use, the corresponding reset value is ignored.



Note Non-zero reset values are useful for defining a position reference offset.

Position can be reset at any time. However, it is recommended that you reset position only while the axis is stopped. An axis reset while the axis is moving will not have a repeatable reference position. Typically, the *Reset Position* function is executed once after the Find Home and Find Index sequences have completed successfully and not called again until the next power-up.

An ADC channel used as a primary or secondary feedback resources is reset by storing an offset value when this function is executed. In this way, its zero reference is not lost and you can still read the actual ADC value with the *Read ADC* function.

flex_set_op_mode

Set Operation Mode

Format

status = flex_set_op_mode (boardID, axisOrVectorSpace, operationMode)

Purpose

Sets the operation mode for an axis or vector space.

Parameters

Input

Name	Type	Description
boardID	u8	assigned by Measurement & Automation Explorer
axisOrVectorSpace	u8	axis or vector space to be controlled
operationMode	u16	mode of operation

Parameter Discussion

axisOrVectorSpace is the axis or vector space to be controlled.

operationMode selects the type of position or velocity mode for an axis or vector space.

operationMode Constant	operationMode Value
NIMC_ABSOLUTE_POSITION	0
NIMC_RELATIVE_POSITION	1
NIMC_VELOCITY	2
NIMC_RELATIVE_TO_CAPTURE	3
NIMC_MODULUS_POSITION	4

These modes are described in the following section.

Using This Function

The *Set Operation Mode* function is used both during initialization and during normal motion control operation to configure the mode of operation for all trajectory commands to the axis or vector space specified.

When sent to a vector space, the operation mode is broadcast to all axes in the vector space to change the per-axis modes. If you later want to operate an axis independently in a different mode, you must execute the *Set Operation Mode* function again for that axis.



Note All axes in a vector space must have the same operation mode. If the operation modes are different on each axis when a *Start Motion* or *Blend Motion* function is executed, an error will be generated.

The operation mode must be set or changed before any other trajectory parameters are loaded for the next move. The operation mode affects how the target position and velocity values are interpreted. Trajectory parameters loaded after a mode change will be interpreted in the newly selected mode.



Note Changing operation mode after the trajectory parameters are loaded can result in improper operation.

There are four position modes and one velocity mode as described in the following sections.

NIMC_ABSOLUTE_POSITION

In absolute position mode, target positions are interpreted with respect to an origin, reference, or zero position. The origin is typically set at a home switch, end of travel limit switch, or encoder index position. An absolute position move will use the preprogrammed values of acceleration, deceleration, s-curve, and velocity to complete a trajectory profile with an ending position equal to the loaded absolute target position.

The length of an absolute move depends upon the loaded position and the current position when the move is started. If the target position is the same as the current position, no move will occur.



Caution Any single move is limited to $\pm(2^{31}-1)$ counts or steps. An error is generated if you exceed this limit by loading a target position too far from the current position.

NIMC_RELATIVE_POSITION

In relative position mode while motion is not in progress, loaded target positions are interpreted with respect to the current position at the time the value is loaded. A relative position move uses the preprogrammed values of acceleration, deceleration, s-curve and velocity to complete a trajectory profile with an ending position equal to the sum of the loaded relative target position and the starting position.

If a relative move is started while motion is in progress, the new target position is calculated with respect to the target position of the move already in progress (considered to be the new starting position), as if that move had already completed successfully. Motion continues to the

new relative position, independent of the actual position location when the new move is started.

In relative mode, the new target position is calculated and double-buffered when you execute either the *Load Target Position* or *Load Vector Space Position* function. You must reload the relative target position each time before executing a *Start Motion* or *Blend Motion* function.

NIMC_VELOCITY

In velocity mode, the axis moves at the loaded velocity until you execute a *Stop Motion* function, a limit is encountered, or a new velocity is loaded and you execute a *Start Motion* function. Load target positions have no effect in velocity mode. The direction of motion is determined by the sign of the loaded velocity.

You can update velocity at any time to accomplish velocity profiling. Changes in velocity while motion is in progress uses the preprogrammed acceleration, deceleration, and s-curve values to control the change in velocity. You can reverse direction by changing the sign of the loaded velocity and executing a *Start Motion* function.



Note Executing a *Blend Motion* function in velocity mode has no effect because the move in process never normally stops. You should always use the *Start Motion* function to update velocity in velocity mode.

Velocity mode is not valid on vector spaces and will generate an error.

NIMC_RELATIVE_TO_CAPTURE

The relative-to-capture position mode is very similar to relative position mode, except that the position reference is the last captured position for the axis or axes. A relative-to-capture position move uses the preprogrammed values of acceleration, deceleration, s-curve and velocity to complete a trajectory profile with an ending position equal to the sum of the loaded target position and the last captured position.

In relative-to-capture mode, the new target position is calculated and double-buffered when you execute either the *Load Target Position* or *Load Vector Space Position* function. These functions use existing values in the position capture register(s). You must load the target position after the capture event has occurred and before executing the *Start Motion* or *Blend Motion* function.

This mode is typically used in registration applications. Refer to the *High-Speed Capture Functions* section in Chapter 8, *Motion I/O Functions*, for more information on the high-speed capture functionality of the encoder inputs.

NIMC_MODULUS_POSITION

In modulus position mode, the loaded target position is interpreted within the boundaries of a modulus range and the direction of motion is automatically chosen to generate the shortest trajectory to the target. To load the modulus range execute the *Load Position Modulus* function.

Modulus position mode is typically used with rotary axes or for other similarly repetitive motion applications.

Example

A rotary tool changer has a modulus of 360° , such that 0° , 360° , 720° , and so on, are the same rotary position.

In modulus position mode, the present position and the desired target position are used to calculate the shortest trajectory to the target position. If the present position is 30° and the target position is 290° , there are two possible moves:

$$290 - 30 = 260^\circ \text{ in the clockwise direction, or}$$

$$290 - 360 - 30 = -100^\circ \text{ in the counterclockwise direction.}$$

Because 100° is the shortest trajectory, the tool changer moves counterclockwise to the target position of 290° .



Note Multiple revolution moves cannot be accomplished by indicating target positions greater than the modulus value. All moves are resolved to one modulus range.

flex_wait_for_blend_complete

Wait for Blend Complete

Format

status = flex_wait_for_blend_complete_status (boardID, axisOrVectorSpace, axisOrVSMap, u32 timeout, i32 pollInterval, blendComplete)

Purpose

Waits up to the specified period of time for a blend to be completed on an axis, vector space, group of axes, or group of vector spaces.

Parameters

Input

Name	Type	Description
boardID	u8	assigned by Measurement & Automation Explorer
axisOrVectorSpace	u8	axis or vector space selector
axisOrVSMap	u16	bitmap of axes or vector spaces to check
timeout	u32	timeout in milliseconds
pollInterval	i32	polling interval in milliseconds

Output

Name	Type	Description
blendComplete	u16	the blend complete status

Parameter Discussion

axisOrVectorSpace can select an axis (1 through 6), vector space (0x11 through 0x13), multiple axes (0), or multiple vector spaces (0x10). When simultaneously waiting for a blend to complete on multiple axes or vector spaces, the **axisOrVSMap** parameter indicates which axes or vector spaces to wait for.

axisOrVSMap is the bitmap of axes or vector spaces to wait for. It is only required when multiple axes or vector spaces are selected with the **axisOrVectorSpace** parameter. Otherwise, this parameter is ignored.

When waiting for multiple axes (**axisOrVectorSpace** = 0):

D15	D14	D13	D12	D11	D10	D9	D8	D7	D6	D5	D4	D3	D2	D1	D0
0	0	0	0	0	0	0	0	0	Axis 6	Axis 5	Axis 4	Axis 3	Axis 2	Axis 1	0

For D1 through D6:

1 = Blend must be complete on specified axis

0 = Blend can be either complete or not complete on specified axis (don't care)

When waiting for multiple vector spaces (**axisOrVectorSpace** = 0x10):

D15	D14	D13	D12	D11	D10	D9	D8	D7	D6	D5	D4	D3	D2	D1	D0
0	0	0	0	0	0	0	0	0	0	0	0	VS 3	VS 2	VS 1	0

For D1 through D3:

1 = Blend must be complete on specified vector space

0 = Blend can be either complete or not complete on specified vector space (don't care)

To wait for blend complete on a single axis or vector space, set the **axisOrVectorSpace** selector to the desired axis or vector space. The **axisOrVSMaP** parameter is ignored.

To wait for blend complete on multiple axes, the **axisOrVectorSpace** selector is set to 0 (zero) and the **axisOrVSMaP** bitmap defines the axes to wait for. They must all be blend complete, for the **blendComplete** output to be true. Similarly, to wait for blend complete on multiple vector spaces, the **axisOrVectorSpace** selector is set to 0x10 and the **axisOrVSMaP** bitmap defines the vector spaces to wait for.

timeout is the amount of time, in milliseconds, to wait for the blend to become complete.

pollInterval is the amount of time, in milliseconds, to wait between successive queries to the controller to determine if the blend is complete.

blendComplete indicates whether or not the blend is complete on the axes or vector spaces specified.

1 = Blend complete

0 = Blend not complete

Using This Function

This utility function is built on top of the [Check Blend Complete Status](#) and [Read Blend Status](#) functions, and is provided for your programming convenience. This function compares the axes or vector spaces specified in the **axisOrVectorSpace** and **axisOrVSMap** input parameters with the blend complete status for the appropriate axes or vector spaces. It does this repetitively, with the **pollInterval** time determining the frequency that the controller is queried. As soon as the blend is complete, the function returns NIMC_noError and the **blendComplete** parameter is set to true (1). This function will wait for the amount of time specified by the timeout parameter, and if the blend is still not complete, the function returns NIMC_eventTimeoutError, and **blendComplete** is set to false (0).

The output is a single true/false value indicating whether or not the specified blend or blends are complete.

For more information on blend complete status, refer to the [Read Blend Status](#) function.

flex_wait_for_move_complete

Wait for Move Complete

Format

status = flex_wait_for_move_complete_status (**boardID**, **axisOrVectorSpace**, **axisOrVSMap**, **u32 timeout**, **i32 pollInterval**, **moveComplete**)

Purpose

Waits up to the specified period of time for a move to be completed on an axis, vector space, group of axes, or group of vector spaces.

Parameters

Input

Name	Type	Description
boardID	u8	assigned by Measurement & Automation Explorer
axisOrVectorSpace	u8	axis or vector space selector
axisOrVSMap	u16	bitmap of axes or vector spaces to check
timeout	u32	timeout in milliseconds
pollInterval	i32	polling interval in milliseconds

Output

Name	Type	Description
moveComplete	u16	the move complete status

Parameter Discussion

axisOrVectorSpace can select an axis (1 through 6), vector space (0x11 through 0x13), multiple axes (0), or multiple vector spaces (0x10). When simultaneously waiting for a move to complete on multiple axes or vector spaces, the **axisOrVSMap** parameter indicates which axes or vector spaces to wait for.

axisOrVSMap is the bitmap of axes or vector spaces to wait for. It is only required when multiple axes or vector spaces are selected with the **axisOrVectorSpace** parameter. Otherwise, this parameter is ignored.

When waiting for multiple axes (**axisOrVectorSpace** = 0):

D15	D14	D13	D12	D11	D10	D9	D8	D7	D6	D5	D4	D3	D2	D1	D0
0	0	0	0	0	0	0	0	0	Axis 6	Axis 5	Axis 4	Axis 3	Axis 2	Axis 1	0

For D1 through D6:

1 = Move must be complete on specified axis

0 = Move can be either complete or not complete on specified axis (don't care)

When waiting for multiple vector spaces (**axisOrVectorSpace** = 0x10):

D15	D14	D13	D12	D11	D10	D9	D8	D7	D6	D5	D4	D3	D2	D1	D0
0	0	0	0	0	0	0	0	0	0	0	0	VS 3	VS 2	VS 1	0

For D1 through D3:

1 = Move must be complete on specified vector space

0 = Move can be either complete or not complete on specified vector space (don't care)

To wait for move complete on a single axis or vector space, set the **axisOrVectorSpace** selector to the desired axis or vector space. The **axisOrVSMap** parameter is ignored.

To wait for move complete on multiple axes, the **axisOrVectorSpace** selector is set to 0 (zero) and the **axisOrVSMap** bitmap defines the axes to wait for. They must all be move complete, for the **moveComplete** output to be true. Similarly, to wait for move complete on multiple vector spaces, the **axisOrVectorSpace** selector is set to 0x10 and the **axisOrVSMap** bitmap defines the vector spaces to wait for.

timeout is the amount of time, in milliseconds, to wait for the move to become complete.

pollInterval is the amount of time, in milliseconds, to wait between successive queries to the controller to determine if the move is complete.

moveComplete indicates whether or not the move is complete on the axes or vector spaces specified.

1 = Move complete

0 = Move not complete

Using This Function

This utility function is built on top of the [Check Move Complete Status](#) and [Read Trajectory Status](#) functions, and is provided for your programming convenience. This function compares the axes or vector spaces specified in the **axisOrVectorSpace** and **axisOrVSMMap** input parameters with the move complete status for the appropriate axes or vector spaces. It does this repetitively, with the **pollInterval** time determining the frequency that the controller is queried. As soon as the move is complete, the function returns `NIMC_noError` and the **moveComplete** parameter is set to true (1). This function will wait for the amount of time specified by the timeout parameter, and if the move is still not complete, the function returns `NIMC_eventTimeoutError`, and **moveComplete** is set to false (0).

The output is a single true/false value indicating whether or not the specified move or moves are complete.

For more information on move complete status, refer to the [Read Trajectory Status](#) and [Configure Move Complete Criteria](#) functions.

Arcs Functions

This subsection contains detailed descriptions of functions that load parameters for circularly interpolated moves. It includes 2D circular arcs, 3D helical arcs, and even full 3D spherical arcs functions.

Circular interpolation is an advanced feature of FlexMotion and is primarily used in continuous path applications such as machining, pattern cutting, liquid dispensing, robotics, and so on. For maximum smoothness and accuracy, the FlexMotion's DSP implements arcs through a cubic spline algorithm.

Arc functions are always sent to a vector space. Velocity and acceleration parameters loaded by executing those functions on the vector space are used as the vector velocity and vector acceleration for all subsequent arc moves. All arc parameters are double-buffered and take effect upon the next *Start Motion* or *Blend Motion* function execution.



Note Arc radius determines the practical range for vector acceleration and velocity. Unrealizable vector values generate an error and the start or blend does not execute.

You can blend arc moves into linearly interpolated moves and vice versa. You can also load all axes in the vector space with the same blend factor using the *Load Blend Factor* function.

Arc moves are defined relative to their starting position and as such, are inherently operated in relative position mode. This approach guarantees that the axes are already on the circle in the $x'y'$ plane, and avoids any impossible situations where the end point of the last move and the beginning of the arc move are not coincident. The mode selected with the *Set Operation Mode* function has no effect on the arc move. It can, however, affect the linearly interpolated vector move you might be blending into or from.

These functions are arranged alphabetically by function name. As a quick reference, a summary of the entire FlexMotion function API is in Appendix B, *FlexMotion Functions*.

flex_load_circular_arc

Load Circular Arc

Format

status = flex_load_circular_arc (**boardID**, **vectorSpace**, **radius**, **startAngle**, **travelAngle**, **inputVector**)

Purpose

Loads parameters for making a circular arc move in a 2D or 3D vector space.

Parameters

Input

Name	Type	Description
boardID	u8	assigned by Measurement & Automation Explorer
vectorSpace	u8	vector space to be controlled
radius	u32	arc radius in counts or steps
startAngle	f64	starting angle for the arc move in the xy plane in degrees
travelAngle	f64	travel angle for the arc move in the xy plane in degrees
inputVector	u8	source of the data for this function

Parameter Discussion

vectorSpace is the vector space to be controlled.

radius is the arc radius in counts (servo axes) or steps (stepper axes). The range is 2 to $2^{31}-1$ counts (steps).

startAngle is the double precision floating point value in degrees of the starting angle of the arc. The range is 0 to 359.999313° where angle 0 is along the positive x axis and values increase counterclockwise from the positive x axis in the xy plane.

travelAngle is the double precision floating point value in degrees of the angle to be traversed. The range is $-1,474,560$ to $+1,474,200^\circ$ ($-4,096$ to $+4,095$ revolutions). A positive **travelAngle** defines counter-clockwise rotation in the xy plane.



Note Internally, the floating point values for **startAngle** and **travelAngle** are represented as scaled, fixed point numbers. See the [Arc Angles in Degrees](#) section in Chapter 4,

Software Overview, for more information on angular units and their effect on arc resolution.

inputVector indicates the source of the data for this function. Available inputVectors include immediate (0xFF) or variable (0x01 through 0x78).



Note The conversion from floating-point to fixed-point is performed on the host computer, not on the FlexMotion controller. To load arc functions from onboard variables, you must use the 16.16 fixed-point representation for all angles.

Using This Function

The *Load Circular Arc* function defines an arc in the xy plane of a 2D or 3D vector space. The arc is specified by a radius, starting angle and travel angle and like all vector space moves, uses the loaded value of vector acceleration and vector velocity to define the motion along the path of the arc. Figure 6-1 defines a circular arc.

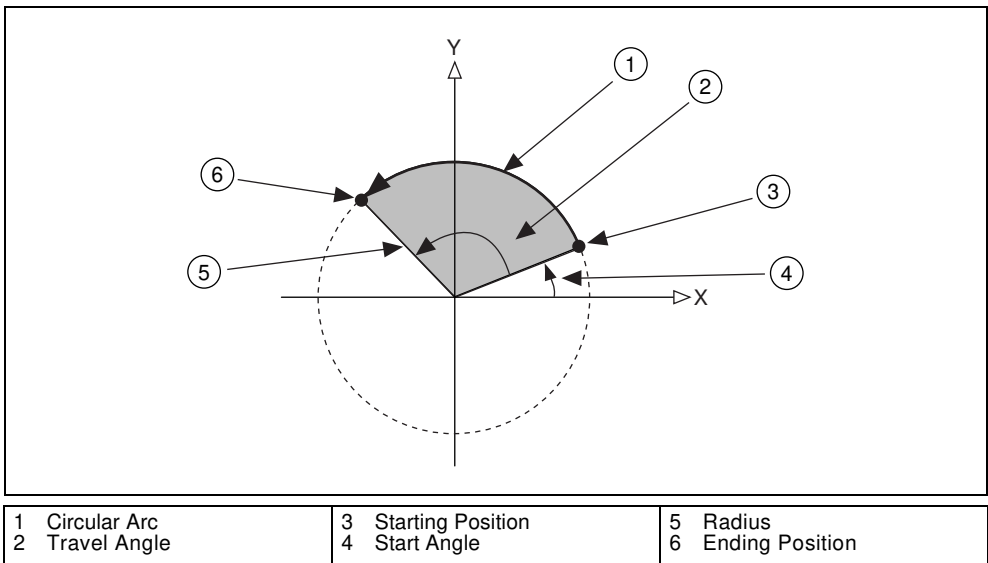

Figure 6-1. CircularArc Definitions

Circular arcs are not limited to $\pm 360^\circ$. Moves of over 4,000 circular revolutions in either direction can be started with one call to this function.

flex_load_helical_arc

Load Helical Arc

Format

status = flex_load_helical_arc (boardID, vectorSpace, radius, startAngle, travelAngle, linearTravel, inputVector)

Purpose

Loads parameters for making a helical arc move in a 3D vector space.

Parameters

Input

Name	Type	Description
boardID	u8	assigned by Measurement & Automation Explorer
vectorSpace	u8	vector space to be controlled
radius	u32	arc radius in counts or steps
startAngle	f64	starting angle for the arc move in the xy plane in degrees
travelAngle	f64	travel angle for the arc move in the xy plane in degrees
linearTravel	i32	linear travel of the z axis in counts or steps
inputVector	u8	source of the data for this function

Parameter Discussion

vectorSpace is the vector space to be controlled.

radius is the arc radius in counts (servo axes) or steps (stepper axes). The range is 2 to $2^{31}-1$ counts (steps).

startAngle is the double precision floating point value in degrees of the starting angle of the arc. The range is 0 to 359.999313° where angle 0 is along the positive x axis and values increase counterclockwise from the positive x axis in the xy plane.

travelAngle is the double precision floating point value in degrees of the angle to be traversed. The range is $-1,474,560$ to $+1,474,200^\circ$ ($-4,096$ to $+4,095$ revolutions). A positive travelAngle defines counter-clockwise rotation in the xy plane.



Note Internally, the floating point values for startAngle and travelAngle are represented as scaled, fixed point numbers. See the [Arc Angles in Degrees](#) section in Chapter 4, [Software Overview](#), for more information on angular units and their effect on arc resolution.

linearTravel is the linear travel of the z axis in counts (servo axes) or steps (stepper axes). The range is $-(2^{31})$ to $+(2^{31}-1)$ counts (steps).



Note Loading a zero (0) for **linearTravel** reduces the helical arc to a circular arc.

inputVector indicates the source of the data for this function. Available inputVectors include immediate (0xFF) or variable (0x01 through 0x78).



Note The conversion from floating-point to fixed-point is performed on the host computer, not on the FlexMotion controller. To load arc functions from onboard variables, you must use the 16.16 fixed-point representation for all angles.

Using This Function

The *Load Helical Arc* function defines an arc in 3D vector space that consist of a circle in the xy plane and synchronized linear travel in the z axis. The arc is specified by a radius, starting angle, travel angle, and z axis linear travel, and like all vector space moves, uses the loaded value of vector acceleration and vector velocity to define the motion along the helical path of the arc. Figure 6-2 defines a helical arc.

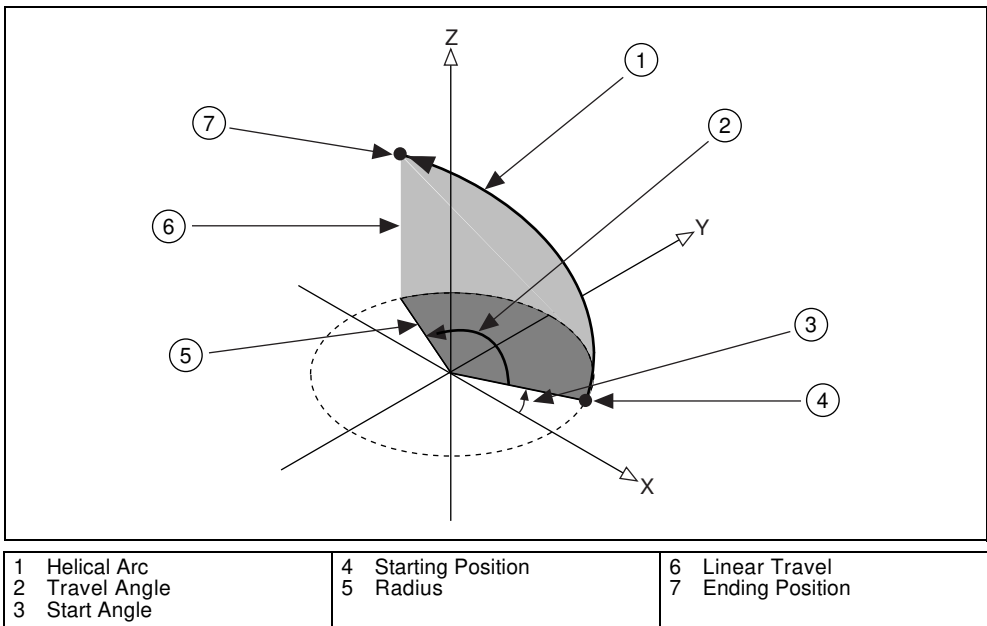

Figure 6-2. Helical Arc Definitions

Like circular arcs, helical arcs are not limited to $\pm 360^\circ$. Moves of up to 4,096 helical twists in either direction can be started with one call to this function.

flex_load_spherical_arc

Load Spherical Arc

Format

status = flex_load_spherical_arc (**boardID**, **vectorSpace**, **radius**, **planePitch**, **planeYaw**, **startAngle**, **travelAngle**, **inputVector**)

Purpose

Loads parameters for making a spherical arc move in a 3D vector space.

Parameters

Input

Name	Type	Description
boardID	u8	assigned by Measurement & Automation Explorer
vectorSpace	u8	vector space to be controlled
radius	u32	arc radius in counts or steps
planePitch	f64	angle between the x' and x axes when the entire x'y'z' vector space is rotated around the y axis
planeYaw	f64	angle between the x' and x axes when the entire x'y'z' vector space is rotated around the z axis
startAngle	f64	starting angle for the arc move in the x'y' plane in degrees
travelAngle	f64	travel angle for the arc move in the x'y' plane in degrees
inputVector	u8	source of the data for this function

Parameter Discussion

vectorSpace is the vector space to be controlled.

radius is the arc radius in counts (servo axes) or steps (stepper axes). The range is 2 to $2^{31}-1$ counts (steps).

planePitch is the double precision floating point value in degrees of the angle between the x' and x axes when the entire x'y'z' vector space is rotated around the y axis. The y' axis remains aligned with the y axis. The range is 0 to 90°. When **planePitch** equals 90°, the positive x' axis is aligned with the negative z axis.

planeYaw is the double precision floating point value in degrees of the angle between the x' and x axes when the entire $x'y'z'$ vector space is rotated around the z axis. The z' axis remains aligned with the z axis. The range is 0 to 359.999313°. When **planeYaw** equals 90°, the positive x' axis is aligned with the positive y axis.



Note Loading zeros for **planePitch** and **planeYaw** reduces the spherical arc to a circular arc.

startAngle is the double precision floating point value in degrees of the starting angle of the arc. The range is 0 to 359.999313° where angle 0 is along the positive x' axis and values increase counterclockwise from the positive x' axis in the $x'y'$ plane.

travelAngle is the double precision floating point value in degrees of the angle to be traversed. The range is $-1,474,560$ to $+1,474,200$ ° ($-4,096$ to $+4,095$ revolutions). A positive **travelAngle** defines counter-clockwise rotation in the $x'y'$ plane.



Note Internally, the floating point values for **planePitch**, **planeYaw**, **startAngle**, and **travelAngle** are represented as scaled, fixed point numbers. See the [Arc Angles in Degrees](#) section in Chapter 4, [Software Overview](#), for more information on angular units and their effect on arc resolution.

inputVector indicates the source of the data for this function. Available **inputVectors** include immediate (0xFF) or variable (0x01 through 0x78).



Note The conversion from floating-point to fixed-point is performed on the host computer, not on the FlexMotion controller. To load arc functions from onboard variables, you must use the 16.16 fixed-point representation for all angles.

Using This Function

The [Load Spherical Arc](#) function defines an arc in the $x'y'$ plane of a coordinate system that has to be transformed by rotation in pitch and yaw from the normal 3D vector space (xyz). In the transformed $x'y'z'$ space, the spherical arc is reduced to a simpler circular arc. It is specified by a radius, starting angle and travel angle, and like all vector space moves, uses the loaded value of vector acceleration and vector velocity to define the motion along the path of the arc in the $x'y'$ plane.

Figure 6-3 shows a graphic representation of the transformation between the $x'y'z'$ and xyz coordinate spaces. The formal definitions of **planePitch** and **planeYaw** are listed in the previous section.

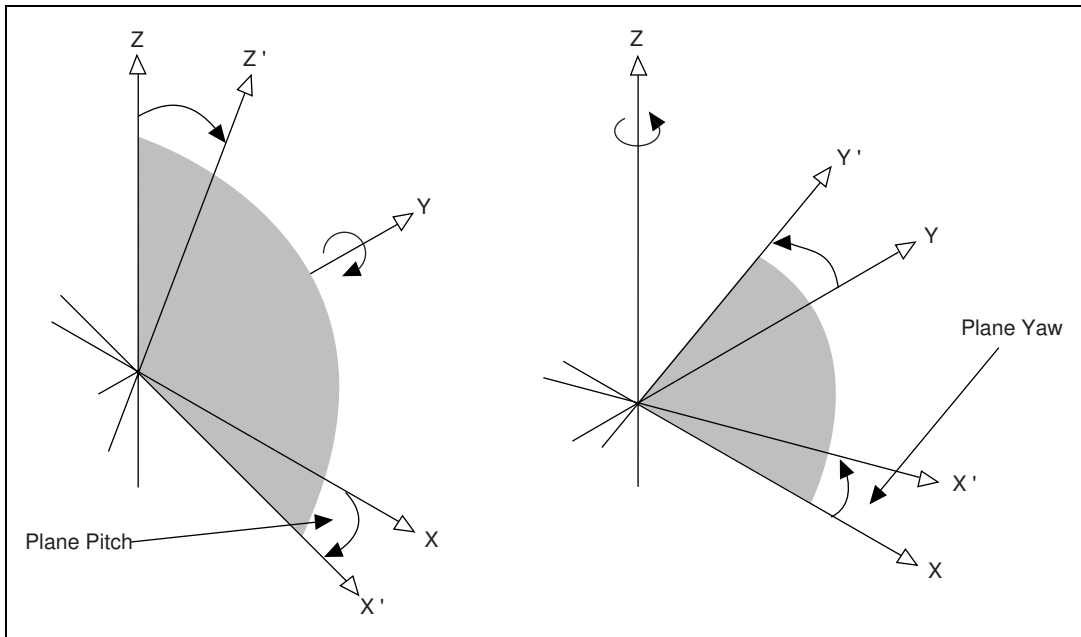

Figure 6-3. Spherical Arc Pitch and Yaw Definitions

Pitch and yaw transformations are inherently confusing because they interact. To avoid ambiguities, you can think about spherical arcs and coordinate transformations as follows:

- The spherical arc is defined as a circular arc in the $x'y'z'$ plane of a transformed vector space $x'y'z'$. The original vector space xyz is defined by the [Configure Vector Space](#) function.
- The transformed vector space $x'y'z'$ is defined in orientation only, with no absolute position offset. Its orientation is with respect to the xyz vector space and is defined in terms of pitch and yaw angles.
- Pitch angle rotation comes before yaw angle rotation.
- When rotating through the pitch angle, the y and y' axes stay aligned with each other while the $x'z'$ plane rotates around them.
- When rotating through the yaw angle, the y' axis never leaves the original xy plane as the newly defined $x'y'z'$ vector space rotates around the original z axis.
- At the beginning of the move, the axes are considered to be already on the arc in the $x'y'z'$ plane. This avoids any impossible situations where the end point of the last move and the beginning of the arc move are not coincident.

Spherical arcs are one of the most powerful, unique and unfortunately complex features of FlexMotion. They allow full 3D curvilinear motion for robotic, solid modeling, and other advanced applications.

Gearing Functions

This subsection contains detailed descriptions of functions used to set up and control master-slave gearing on the FlexMotion controller. It includes functions to configure a gear master, load a gear ratio, and enable master-slave gearing.

Gearing is an advanced feature of FlexMotion and is used in applications where either the master axis is not under control of the FlexMotion controller or whenever extremely tight synchronization between multiple axes is required.

These functions are arranged alphabetically by function name. As a quick reference, a summary of the entire FlexMotion function API is in Appendix B, *FlexMotion Functions*.

flex_config_gear_master

Configure Gear Master

Format

`status = flex_config_gear_master (boardID, axis, masterAxisOrEncoderOrADC)`

Purpose

Assigns a master axis, encoder, or ADC channel for master-slave gearing.

Parameters

Input

Name	Type	Description
boardID	u8	assigned by Measurement & Automation Explorer
axis	u8	slave axis to be controlled
masterAxisOrEncoderOrADC	u8	axis, encoder or ADC channel to be used as the master

Parameter Discussion

axis is the slave axis to be controlled.

masterAxisOrEncoderOrADC is the axis (1 through 6) trajectory generator, encoder (0x21 through 0x26), or ADC channel (0x51 through 0x58) to be used as the master for this slave axis. A zero (0) value means no master is assigned (default).

Using This Function

The *Configure Gear Master* function assigns a master axis, encoder, or ADC channel to the slave axis selected. Any number of slave axes can have the same master, but each slave axis can have only one master.

You must call the *Configure Gear Master* function prior to enabling master-slave gearing with the *Enable Gearing* function. The usual source of master position is either an independent encoder or ADC channel or the feedback resource of an enabled axis. In either case, you assign the resource, not the axis, as the master. You must enable independent master resources with the *Enable Encoders* or *Enable ADCs* functions.

When an axis is assigned as the master, its trajectory generator output (not its feedback position) is used as the master position command. This mode of operation can eliminate the following error skew between the master and slave axes and is especially useful in gantry applications. The master axis can be operating in any mode (including being a slave to another master).

Master-slave functionality of slave axes is in addition to their normal mode of operation. This allows a point-to-point move to be superimposed upon the slave while the slave axis is in motion due to being geared to its master. This functionality is useful for registration and reference offset moves.

Refer to the *Load Gear Ratio* and *Enable Gearing* functions for more information on master-slave gearing.

flex_enable_gearing

Enable Gearing

Format

`status = flex_enable_gearing (boardID, gearMap)`

Purpose

Enables slave axes for master-slave gearing.

Parameters

Input

Name	Type	Description
boardID	u8	assigned by Measurement & Automation Explorer
gearMap	u16	bitmap of slave axes to enable for gearing

Parameter Discussion

`gearMap` is the bitmap of slave axes to enable for gearing.

D15	D14	D13	D12	D11	D10	D9	D8	D7	D6	D5	D4	D3	D2	D1	D0
0	0	0	0	0	0	0	0	0	Axis 6	Axis 5	Axis 4	Axis 3	Axis 2	Axis 1	0

D1 through D6:

1 = Gearing enabled

0 = Gearing disabled (default)

Using This Function

The *Enable Gearing* function enables and disables master-slave gearing functionality of slave axes. When gearing is enabled, the positions of the slave axes and their corresponding masters are recorded as their absolute gearing reference. From then on, as long as the gear ratio remains absolute, every incremental change of a master position is multiplied by the corresponding absolute gear ratio and applied to the slave axis. See the *Load Gear Ratio* function for more information about absolute versus relative gear ratios.

You must call the *Configure Gear Master* and *Load Gear Ratio* functions prior to enabling master-slave gearing. In addition, you must enable and activate the slave axes before enabling gearing. An error is generated if a slave is killed when gearing is enabled. These checks ensure that the slave axis enables in a controlled fashion.

You can call the *Enable Gearing* function at any time to disable gearing or to re-enable gearing with new absolute gearing reference positions. If gearing is disabled on a moving axis, the axis immediately stops but remains active. If the slave axis was also implementing a superimposed move, the superimposed move decelerates to a stop.

Executing the *Stop Motion* function on a slave axis stops the axis and automatically disables gearing for that axis. *Find Home* and *Find Index* functions cannot be executed on slave axes with gearing enabled. An error will be generated and the find sequence will not start.

flex_enable_gearing_single_axis

Enable Gearing Single Axis

Format

status = flex_enable_gearing_single_axis (boardID, axis, enable)

Purpose

Enables a slave axis for master-slave gearing.

Parameters

Input

Name	Type	Description
boardID	u8	assigned by Measurement & Automation Explorer
axis	u8	axis to be enabled or disabled
enable	u16	enable/disable value

Parameter Discussion

axis is the axis to be enabled or disabled.

enable indicates whether to enable or disable the slave axis for gearing.

1 = Gearing enabled

0 = Gearing disabled

Using This Function

This function is similar to the [Enable Gearing](#) function, but allows you to enable or disable gearing on a single axis without affecting the other axes.

The [Enable Gearing Single Axis](#) function enables and disables master-slave gearing functionality of a slave axis. When gearing is enabled, the position of the slave axis and its corresponding master is recorded as its absolute gearing reference. From then on, as long as the gear ratio remains absolute, every incremental change of a master position is multiplied by the corresponding absolute gear ratio and applied to the slave axis. See the [Load Gear Ratio](#) function for more information about absolute versus relative gear ratios.

You must call the [Configure Gear Master](#) and [Load Gear Ratio](#) functions prior to enabling master-slave gearing. In addition, you must enable and activate the slave axis before enabling gearing. An error is generated if the slave is killed when gearing is enabled. These checks ensure that the slave axis enables in a controlled fashion.

You can call the *Enable Gearing Single Axis* function at any time to disable gearing or to re-enable gearing with new absolute gearing reference positions. If gearing is disabled on a moving axis, the axis immediately stops but remains active. If the slave axis was also implementing a superimposed move, the superimposed move decelerates to a stop.

Executing the *Stop Motion* function on a slave axis stops the axis and automatically disables gearing for that axis. *Find Home* and *Find Index* functions cannot be executed on slave axes with gearing enabled. An error will be generated and the find sequence will not start.

flex_load_gear_ratio

Load Gear Ratio

Format

status = flex_load_gear_ratio (boardID, axis, absoluteOrRelative, ratioNumerator, ratioDenominator, inputVector)

Purpose

Loads the gear ratio for master-slave gearing.

Parameters

Input

Name	Type	Description
boardID	u8	assigned by configuration utility
axis	u8	slave axis to be controlled
absoluteOrRelative	u16	selects absolute or relative gearing between master and slave
ratioNumerator	i16	gear ratio numerator of the slave relative to the master
ratioDenominator	u16	gear ratio denominator of the slave relative to the master
inputVector	u8	source of the data for this function

Parameter Discussion

axis is the slave axis to be controlled.

absoluteOrRelative selects absolute (0) or relative (1) gearing between the master and slave.

ratioNumerator is gear ratio numerator of the slave relative to the master. The numerator is a signed value between $-32,768$ to $+32,767$ to allow for both positive and negative gearing.

ratioDenominator is the gear ratio denominator of the slave relative to the master. The denominator must be between 1 to 32,767.

inputVector indicates the source of the data for this function. Available inputVectors include immediate (0xFF) or variable (0x01 through 0x78).

Using This Function

The *Load Gear Ratio* function loads the gear ratio of the slave axis relative to its master and selects whether this ratio is absolute or relative. The ratio is loaded as a numerator and denominator because it is a natural format for a ratio (numerator: denominator) and it allows a broad range of ratios, from 1:32,767 to 32,767:1. The ratio is always specified as slave relative to master (slave:master).

When you execute the *Enable Gearing* function, the positions of the slave and its master are recorded as their absolute gearing reference. From then on, as long as the gear ratio remains absolute, every incremental change of the master position is multiplied by the absolute gear ratio and applied to the slave axis or axis.

If a relative gear ratio is selected and loaded after gearing is enabled, the position of the master is recorded as its relative reference point and every incremental change from this reference point is multiplied by the relative gear ratio and applied to the slave axis or axis.



Note While changing an absolute gear ratio on the fly is allowed, you should be careful because the slave axis will jump with full torque to the position defined by the new ratio even when the master position has not changed.

The *Load Gear Ratio* function must be called prior to enabling master-slave gearing with the *Enable Gearing* function. Often the positions of the master and slave are reset to zero or some known position prior to enabling gearing, though this is not always required. The execution of the *Enable Gearing* function stores both positions as offsets and gears them from that point onward.

Because relative gearing does not maintain an absolute relationship between master and slave positions over time, you can use periodic calls to this function with the appropriate absolute gear ratio to force the slave back into gearing alignment.

Master-slave functionality of slave axes is in addition to their normal mode of operation. This allows a point-to-point move to be superimposed upon the slave while the slave axis is in motion due to being geared to its master. This functionality is useful for registration and reference offset moves.

Refer to the *Configure Gear Master* and *Enable Gearing* functions for more information on master-slave gearing.

Example

To load a slave to master gear absolute gear ratio of 3:2, call the *Load Gear Ratio* function with **absoluteOrRelative** = 0 (absolute), **ratioNumerator** = 3 and **ratioDenominator** = 2. For for two axes with identical resolution, setting a gear ratio of 3:2 results in the slave axis rotating three revolutions for every two revolutions of the master.

Advanced Trajectory Functions

This subsection contains detailed descriptions of advanced trajectory functions. These functions are useful in special applications and showcase some of FlexMotion's power and flexibility.

Included in this section are the functions to acquire time-sampled position and velocity data into a large onboard buffer and then later read it out for analysis and display. These functions implement a digital oscilloscope that is useful during system setup, PID tuning, and general motion with data acquisition synchronization.

These functions are arranged alphabetically by function name. As a quick reference, a summary of the entire FlexMotion function API is in Appendix B, *FlexMotion Functions*.

flex_acquire_trajectory_data

Acquire Trajectory Data

Format

status = flex_acquire_trajectory_data (boardID, axisMap, numberOfSamples, timePeriod)

Purpose

Acquires time-sampled position and velocity data on multiple axes.

Parameters

Input

Name	Type	Description
boardID	u8	assigned by Measurement & Automation Explorer
axisMap	u16	bitmap of axes to acquire data for
numberOfSamples	u16	number of samples to acquire
timePeriod	u16	time period between samples in ms

Parameter Discussion

axisMap is the bitmap of axes to acquire data for.

D15	D14	D13	D12	D11	D10	D9	D8	D7	D6	D5	D4	D3	D2	D1	D0
0	0	0	0	0	0	0	0	0	Axis 6	Axis 5	Axis 4	Axis 3	Axis 2	Axis 1	0

D1 through D6:

1 = Acquire samples on this axis

0 = Do not acquire samples (default)

numberOfSamples is the number of samples to acquire. The maximum number of samples depends upon the number of axes selected by **axisMap**:

$$\text{numberOfSamples (max)} = 4096 / \text{number of axes}$$

With 1 axis selected, the maximum is 4,096 samples. With all six axes selected, the maximum is 682 samples.

timePeriod is the time period between samples in ms. The range is from 3 (default) to 65,535 ms.

Using This Function

The *Acquire Trajectory Data* function initiates the automatic acquisition of position and velocity data for the selected axes. The data is held in an onboard first-in-first-out (FIFO) buffer until later read back with the *Read Trajectory Data* function. You can select which axes to acquire data for and program the time period between samples.

The *Acquire Trajectory Data* and *Read Trajectory Data* functions are used to acquire and read back time-sampled position and velocity data for analysis and display. These functions implement a digital oscilloscope that is useful during system setup, PID tuning, and general motion with data acquisition synchronization.

Once started, this data acquisition operates autonomously in the background as a separate task. Motion control operates normally and you can execute other motion functions simultaneously. Depending upon the programmed time period and the total number of samples, this acquisition task can run anywhere from a few milliseconds to tens of hours.



Caution Wait an appropriate amount of time before attempting to read back the trajectory data.

Example

To acquire 100 samples of data on axes 1, 2, and 5 at 10 ms/sample, call the *Acquire Trajectory Data* function with the following parameters:

axisMap = 0x0026, corresponding to the following bitmap

D15	D14	D13	D12	D11	D10	D9	D8	D7	D6	D5	D4	D3	D2	D1	D0
0	0	0	0	0	0	0	0	0	Axis 6	Axis 5	Axis 4	Axis 3	Axis 2	Axis 1	0
0	0	0	0	0	0	0	0	0	0	1	0	0	1	1	0

numberOfSamples = 100

timePeriod = 10

flex_load_base_vel

Load Base Velocity

Format

status = flex_load_base_vel (boardID, axis, baseVelocity, inputVector)

Purpose

Sets the base velocity used by the trajectory control circuitry for the axis specified.

Parameters

Input

Name	Type	Description
boardID	u8	assigned by Measurement & Automation Explorer
axis	u8	axis to be controlled
baseVelocity	u16	base velocity for the stepper axis in steps/second
inputVector	u8	source of the data for this function

Parameter Discussion

baseVelocity is loaded in steps per second and is a 16-bit data word in the range of 0 through 65,535. The default value is 0.

Using This Function

Base velocity is the minimum step rate used by the trajectory generator during acceleration and deceleration. Larger or smaller values can be used to optimize the low frequency performance of certain stepper motors.

If the target velocity loaded with the [Load Velocity](#) function is lower than the base velocity, the base velocity is reduced to equal the loaded target velocity.



Note This function is valid only on axes configured as steppers, so you must configure an axis as a stepper using the [Configure Axis Resources](#) function before executing this function.

flex_load_blend_fact

Load Blend Factor

Format

status = flex_load_blend_fact (boardID, axisOrVectorSpace, blendFactor, inputVector)

Purpose

Loads the blend factor for an axis or vector space.

Parameters

Input

Name	Type	Description
boardID	u8	assigned by Measurement & Automation Explorer
axisOrVectorSpace	u8	axis or vector space to be controlled
blendFactor	i16	the mode and/or dwell used during blending
inputVector	u8	source of the data for this function

Parameter Discussion

axisOrVectorSpace is the axis or vector space to be controlled.

blendFactor is the blend factor mode and/or dwell time. -1 specifies normal blending (default), 0 specifies a start after the previous move is fully stopped, and values > 0 specify additional dwell time in milliseconds.

inputVector indicates the source of the data for this function. Available inputVectors include immediate (0xFF) or variable (0x01 through 0x78).

Using This Function

The *Load Blend Factor* function controls how the *Blend Motion* function operates. Blending automatically starts a pending move on an axis or vector space when the move in process completes. Exactly when the pending move starts is determined by the loaded blend factor.

A blend factor of -1 causes the pending move to start when the existing move finishes its constant velocity segment and starts to decelerate, as shown in Figure 6-4. This blends the two moves together at the optimum blend point.

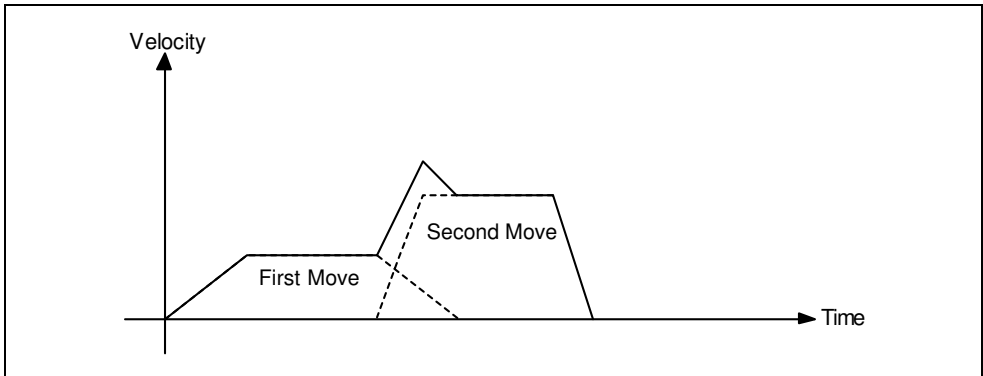

Figure 6-4. Blending with Blend Factor of -1

If the two moves are at the same velocity, in the same direction, and have matching acceleration and deceleration, they will superimpose perfectly without a dip or increase in velocity.

For a vector move, if all of the axes are continuing in the same direction, the vector velocity remains constant. But, if one of the axes changes direction, the vector velocity does not remain constant during the transition phase.

A blend factor of zero (0) causes the pending move to start when the existing move fully completes its profile, as shown in Figure 6-5.

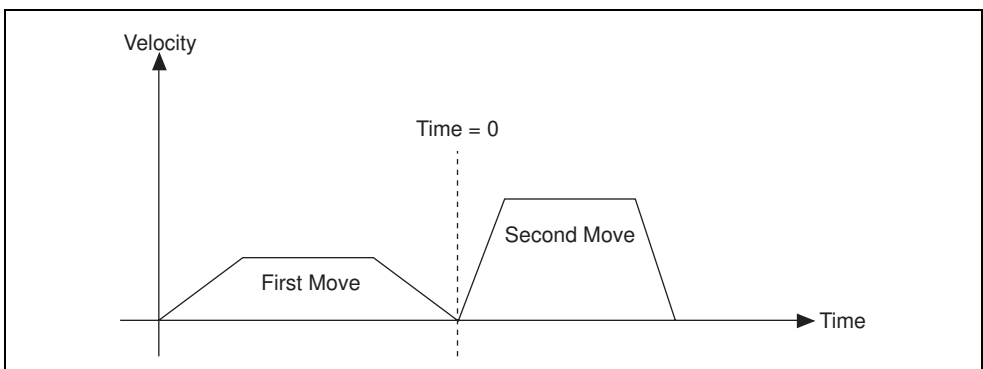

Figure 6-5. Blending with Blend Factor of 0

Positive blend factors allow for a dwell at the end of the first move before the automatic start of the pending move, as shown in Figure 6-6. The blend factor dwell is programmed in milliseconds.

The maximum value of the positive blend factor depends upon the **PIDrate** that you set in the *Enable Axes* function, because the DSP delays the trajectory generators based on PID sample periods. The formula used to determine the maximum positive blend factor is as follows:

$$s = (time \times 1000)/PIDrate$$

where s is the time in sample periods, $time$ is the positive blend factor value in milliseconds, and **PIDrate** is in microseconds (62.5, 125, 188, 250, 312, 375, 438, or 500).

If $s > 32,767$, it is coerced to 32,767 sample periods.

At a **PIDrate** of 500 μ s, the maximum value of the positive blend factor is 16,383 ms and at a **PIDrate** of 250 μ s, the maximum value is 8,192 ms.

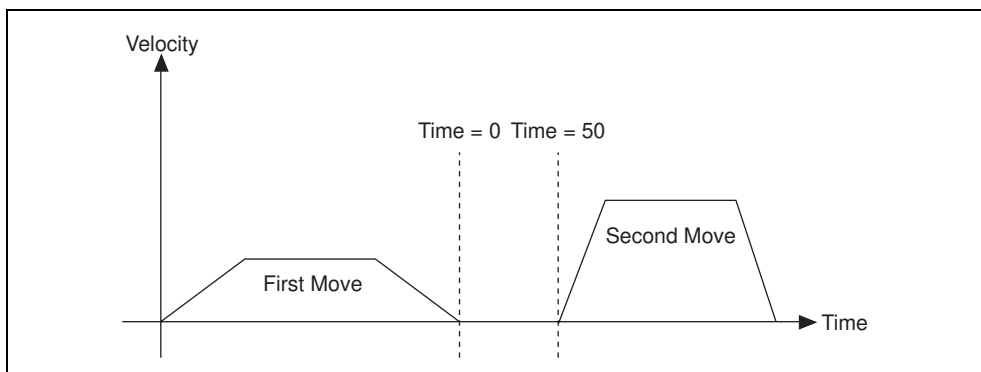

Figure 6-6. Blending with Blend Factor of 50 ms

If the first move has already completed when the *Blend Motion* function is executed, the second move will still wait the dwell time before starting.

You can load blend factors to individual axes or to a vector space for coordinated blending of all axes in the vector space. When sent to a vector space, the blend factor is broadcast to all axes in the vector space to change the per-axis blend factors. If you later want to operate an axis independently with a different blend factor, you must execute the *Load Blend Factor* function again for that axis.



Note All axes in a vector space must have the same blend factor. If the blend factors are different on each axis when you execute a *Blend Motion* function, an error is generated.

flex_load_pos_modulus

Load Position Modulus

Format

status = flex_load_pos_modulus (boardID, axis, positionModulus, inputVector)

Purpose

Loads the position modulus for an axis.

Parameters

Input

Name	Type	Description
boardID	u8	assigned by Measurement & Automation Explorer
axis	u8	axis to be controlled
positionModulus	u32	position modulus value in counts or steps
inputVector	u8	source of the data for this function

Parameter Discussion

axis is the axis to be controlled.

positionModulus is the position modulus value in counts (servo axes) or steps (stepper axes). The modulus range is from 0 (default) to $2^{31}-1$.

inputVector indicates the source of the data for this function. Available inputVectors include immediate (0xFF) or variable (0x01 through 0x78).

Using This Function

The *Load Position Modulus* function sets the modulus used when the axis is operating in Modulus Position mode. It has no effect when the axis is operating in other modes. When a target position is loaded, it is interpreted within the boundaries of a modulus range.

See the *Set Operation Mode* function for a complete description of the Modulus Position mode.

flex_load_rpm_thresh

Load Velocity Threshold in RPM

Format

status = flex_load_rpm_thresh (boardID, axis, threshold, inputVector)

Purpose

Loads a velocity threshold for an axis in RPM.

Parameters

Input

Name	Type	Description
boardID	u8	assigned by Measurement & Automation Explorer
axis	u8	axis to be controlled
threshold	f64	velocity threshold in RPM
inputVector	u8	source of the data for this function

Parameter Discussion

axis is the axis to be controlled.

threshold is the velocity threshold value in RPM expressed as a double-precision floating point number. The RPM range depends upon the motor counts or steps per revolution and the trajectory update rate, and is always a positive number. Refer to the [Trajectory Parameters](#) section in Chapter 4, [Software Overview](#), for more information on velocity and acceleration units and their dependency on trajectory update rate.

inputVector indicates the source of the data for this function. Available inputVectors include immediate (0xFF) or variable (0x01 through 0x78).

Using This Function

The [Load Velocity Threshold](#) function establishes a velocity threshold in RPM for the specified axis which can then be monitored with the [Read Trajectory Status](#) function. The velocity threshold status is True when the absolute value of filtered axis velocity is above the threshold and False when the velocity drops below the threshold.

Velocity threshold is a status and does not have to be enabled or disabled. Loading a maximum value effectively disables the feature because the status will always be off. Increasing the

velocity filter time constant with the *Configure Velocity Filter* function reduces quantization noise in the threshold status but at the expense of increasing threshold status latency.

Velocity threshold is typically used to monitor the acceleration and deceleration trajectory periods to see when or if an axis is up to speed. You can then change PID tuning or other parameters as a function of velocity.

flex_load_scurve_time

Load S-Curve Time

Format

status = flex_load_scurve_time (boardID, axisOrVectorSpace, sCurveTime, inputVector)

Purpose

Loads the s-curve time for an axis or vector space.

Parameters

Input

Name	Type	Description
boardID	u8	assigned by Measurement & Automation Explorer
axisOrVectorSpace	u8	axis or vector space to be controlled
sCurveTime	u16	smoothing time in update sample periods
inputVector	u8	source of the data for this function

Parameter Discussion

axisOrVectorSpace is the axis or vector space to be controlled.

sCurveTime is the time in update sample periods over which the acceleration profile is smoothed as it transitions from zero to the programmed value and back to zero. The s-curve range is from 1 to 32,767 with a default of 1 sample period.

inputVector indicates the source of the data for this function. Available inputVectors include immediate (0xFF) or variable (0x01 through 0x78).

Using This Function

The *Load S-Curve Time* function smooths the acceleration and deceleration portions of a motion profile, resulting in less abrupt transitions from start motion to acceleration, acceleration to constant velocity, constant velocity to deceleration, and deceleration to stop. Using s-curve acceleration limits the jerk in a motion control system.

Officially, jerk is defined as the derivative of acceleration (change of acceleration per unit time) and is measured in units of counts (steps)/s³. This function, however, allows you to load s-curve time in update sample periods rather than have to deal with the obscure units of jerk.

With the default s-curve time of one (1) sample period, there is virtually no affect on the motion profile, and the standard trapezoidal trajectory is executed. As s-curve time increases, the smoothing affect on the acceleration and deceleration portions of the motion profile increase, as shown in Figure 6-7. Large values of s-curve time can override the programmed values of acceleration and deceleration by sufficiently smoothing the profile such that the acceleration and deceleration slopes are never reached.

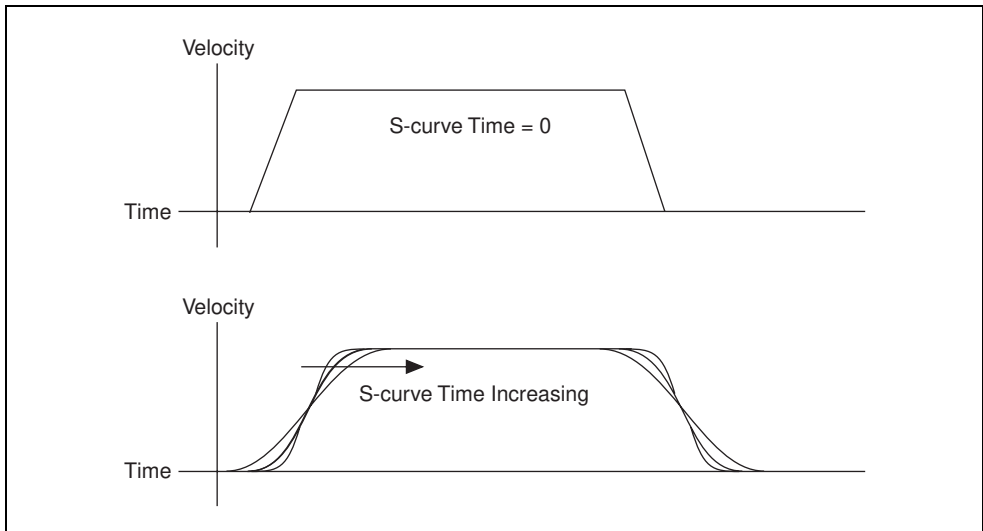

Figure 6-7. Effects of S-Curve Acceleration on a Trapezoidal Trajectory



Note With increasing s-curve, the overall time to reach the target position increases given the same velocity, acceleration, and deceleration parameters.

You can load s-curve time to individual axes or to a vector space for smoothing all axes in the vector space. When sent to a vector space, the s-curve time is broadcast to all axes in the vector space to change the per-axis s-curve times. If you later want to operate an axis independently with a different s-curve time, you must execute the *Load S-Curve Time* function again for that axis.



Note All axes in a vector space should have the same s-curve time for best vector accuracy.

flex_load_torque_lim

Load Torque Limit

Format

status = flex_load_torque_lim (boardID, axis, primaryPositiveLimit, primaryNegativeLimit, secondaryPositiveLimit, secondaryNegativeLimit, inputVector)

Purpose

Loads primary and secondary DAC torque limits for an axis.

Parameters

Input

Name	Type	Description
boardID	u8	assigned by Measurement & Automation Explorer
axis	u8	axis to be controlled
primaryPositiveLimit	i16	positive limit for primary DAC
primaryNegativeLimit	i16	negative limit for primary DAC
secondaryPositiveLimit	i16	positive limit for optional secondary DAC
secondaryNegativeLimit	i16	negative limit for optional secondary DAC
inputVector	u8	source of the data for this function

Parameter Discussion

axis is the axis to be controlled.

primaryPositiveLimit is the primary DAC positive torque (or velocity) limit. The range is $-32,768$ to $+32,767$ (-10 V to $+10$ V) with a default value of $32,767$ ($+10$ V).

primaryNegativeLimit is the primary DAC negative torque (or velocity) limit. The range is $-32,768$ to $+32,767$ (-10 V to $+10$ V) with a default value of $-32,767$ (-10 V).



Note The positive limit cannot be less than the negative limit.

secondaryPositiveLimit is the optional secondary DAC positive torque (or velocity) limit. The range is $-32,768$ to $+32,767$ (-10 V to $+10$ V) with a default value of $32,767$ ($+10$ V).

secondaryNegativeLimit is the optional secondary DAC negative torque (or velocity) limit. The range is $-32,768$ to $+32,767$ (-10 V to $+10$ V) with a default value of $-32,767$ (-10 V).



Note The positive limit cannot be less than the negative limit.

inputVector indicates the source of the data for this function. Available inputVectors include immediate (0xFF) or variable (0x01 through 0x78).

Using This Function

The *Load Torque Limit* function allows you to limit the output range of the DAC output(s) on the selected servo axis. This function has no effect on stepper axes or independent DAC outputs that are not mapped to an axis.

By limiting the output range of a DAC, it is possible to control the maximum torque (when connected to a torque block servo amplifier) or velocity (when connected to a velocity block servo amplifier). This function is also helpful when interfacing to amplifiers that do not support the standard ± 10 V command range.

Primary and secondary DACs can have different limits, and the positive and negative limits can be both positive or both negative to limit the DAC output to a unipolar range. The only restriction is that a positive DAC limit cannot be less than the negative DAC limit.

You can also set a torque offset on the primary and secondary DAC outputs. See the *Load Torque Offset* function for more information.

Example

Calling the *Load Torque Limit* function with the following parameters limits the output ranges of the primary and secondary DACs mapped to the axis, as shown in Figure 6-8.

primaryPositiveLimit = 16,383

primaryNegativeLimit = $-16,384$

secondaryPositiveLimit = 8,191

secondaryNegativeLimit = $-32,768$

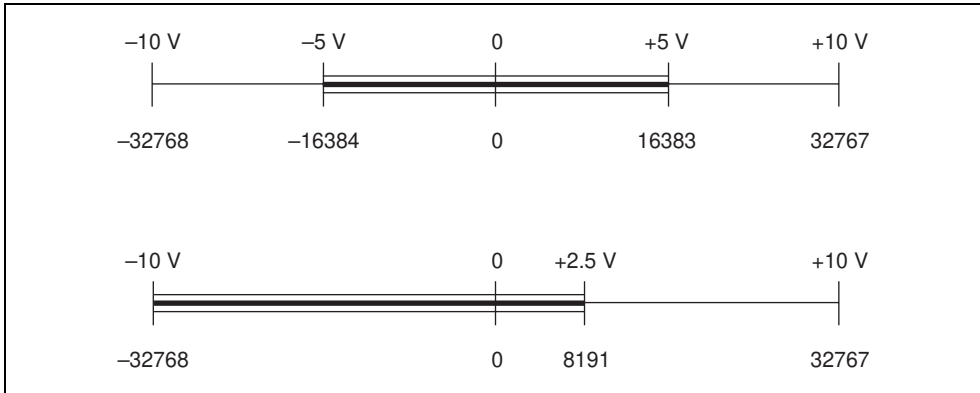

Figure 6-8. Primary and Secondary Torque Limits Example

The result of this function call is to limit the primary DAC to only half its range in either direction, or ± 5 V. The secondary DAC can only travel over a quarter of its positive range but has its full negative range.

flex_load_torque_offset

Load Torque Offset

Format

status = flex_load_torque_offset (boardID, axis, primaryOffset, secondaryOffset, inputVector)

Purpose

Loads primary and secondary DAC torque offsets for an axis.

Parameters

Input

Name	Type	Description
boardID	u8	assigned by Measurement & Automation Explorer
axis	u8	axis to be controlled
primaryOffset	i16	offset for primary DAC
secondaryOffset	i16	offset for secondary DAC
inputVector	u8	source of the data for this function

Parameter Discussion

axis is the axis to be controlled.

primaryOffset is the primary DAC torque (or velocity) offset. The offset range is $-32,768$ to $+32,767$ (-10 V to $+10$ V) with a default value of 0 (0 V).

secondaryOffset is the secondary DAC torque (or velocity) offset. The offset range is $-32,768$ to $+32,767$.



Note The offset value must be within the range limits set by the [Load Torque Limit](#) function.

inputVector indicates the source of the data for this function. Available inputVectors include immediate ($0xFF$) or variable ($0x01$ through $0x78$).

Using This Function

The *Load Torque Offset* function loads offset values for the DACs mapped to the selected servo axis. This function has no effect on stepper axes or independent DAC outputs that are not mapped to an axis. When a DAC is connected to a velocity block servo amplifier, the torque offset functions as a velocity offset.

A torque (or velocity) offset shifts the DAC output(s) by the programmed offset value without requiring any action from the PID loop. In a servo system, this can be used to overcome amplifier input offsets, system imbalances, or the effects of outside forces such as gravity. Different torque offsets can be loaded for the primary and secondary DAC.



Note When an axis is killed, its DAC outputs are zeroed regardless of the torque offset loaded.

DAC offsets can be used in conjunction with DAC range limits to interface to servo amplifiers with unipolar input ranges (for example, 0 to 5 V or 0 to 10 V)

Example

Calling the *Load Torque Offset* function with **primaryOffset** = 4,096 and **secondaryOffset** = 0 shifts the output ranges of the primary DAC mapped to the axis as shown in Figure 6-9.

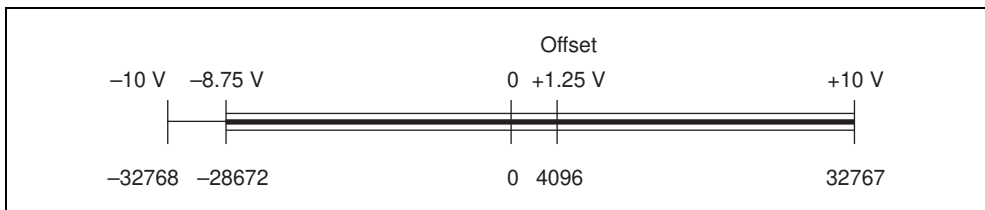

Figure 6-9. Torque Offset Example

The result of this function call is to limit the primary DAC to a range of -8.75 V to $+10\text{ V}$ with an offset or null value of $+1.25\text{ V}$. This is because even when the PID loop is commanding full negative torque, the torque offset is added and the resulting output is -8.75 V . In the positive direction, the DAC cannot go above $+10\text{ V}$ no matter what the offset is.

The function call leaves the secondary DAC offset at its default value of zero (0). This example assumes the full torque range is available and not limited by the *Load Torque Limit* function.



Note The offset value must be within the range limits set by the *Load Torque Limit* function.

flex_load_vel_threshold

Load Velocity Threshold

Format

status = flex_load_vel_threshold (boardID, axis, threshold, inputVector)

Purpose

Loads a velocity threshold for an axis.

Parameters

Input

Name	Type	Description
boardID	u8	assigned by Measurement & Automation Explorer
axis	u8	axis to be controlled
threshold	u32	velocity threshold in counts/s or steps/s
inputVector	u8	source of the data for this function

Parameter Discussion

axis is the axis to be controlled.

threshold is the velocity threshold in counts/s (servo axes) or steps/s (stepper axes). For servo axes, the threshold range is 1 to 16,000,000 counts/s. For stepper axes, it is 1 to 1,500,000 steps/s. The factory default value for threshold is the maximum, so the feature is effectively disabled until a threshold is loaded.

inputVector indicates the source of the data for this function. Available inputVectors include immediate (0xFF) or variable (0x01 through 0x78).

Using This Function

The *Load Velocity Threshold* function establishes a velocity threshold for the specified axis, which can then be monitored with the *Read Trajectory Status* function. The velocity threshold status is True when the absolute value of filtered axis velocity is above the threshold and False when the velocity drops below the threshold.

Velocity threshold is a status and does not have to be enabled or disabled. Loading a maximum value effectively disables the feature because the status will always be off. Increasing the velocity filter time constant with the *Configure Velocity Filter* function will

reduce quantization noise in the threshold status but at the expense of increasing threshold status latency.

Velocity threshold is typically used to monitor the acceleration and deceleration trajectory periods to see when or if an axis is up to speed. You can then change PID tuning or other parameters as a function of velocity.

flex_load_velocity_override

Load Velocity Override

Format

status = flex_load_velocity_override (boardID, axisOrVectorSpace, overridePercentage, inputVector)

Purpose

Loads an instantaneous velocity override for an axis or vector space.

Parameters

Input

Name	Type	Description
boardID	u8	assigned by Measurement & Automation Explorer
axisOrVectorSpace	u8	axis or vector space to be controlled
overridePercentage	f32	velocity override scale factor
inputVector	u8	source of the data for this function

Parameter Discussion

axisOrVectorSpace is the axis or vector space to be controlled.

overridePercentage is a single precision floating point value from 0 to 150%. This value directly scales the programmed velocity. The default value is 100% (no effect).



Note Internally, this value is converted to an integer multiplier with a range of 0 to 384, where 256 (0x100) corresponds to 100%. Therefore, the resolution of this function is approximately 0.4%.

inputVector indicates the source of the data for this function. Available inputVectors include immediate (0xFF) or variable (0x01 through 0x78).



Note The conversion from floating-point to fixed-point is performed on the host computer, not on the FlexMotion controller. To load velocity override from an onboard variable, you must use the integer representation of 0 to 384.

Using This Function

The *Load Velocity Override* function scales the operating velocity on an axis or vector space from 0 to 150%. Velocity override is not double-buffered. The function takes effect immediately and does not require a *Start Motion* or *Blend Motion* function execution to change the operating velocity. All velocity changes use the loaded values of acceleration, deceleration, and s-curve to smoothly transition the velocity to its new value.

Velocity override scales velocity in all operation modes on all single axis and vector space moves including 2D and 3D linear interpolation and circular, helical, and spherical arcs.

You can load velocity override to individual axes or to a vector space for coordinated velocity scaling. When sent to a vector space, the velocity override is broadcast to all axes in the vector space to change the per-axis overrides. If you later want to operate an axis independently with a different velocity override, you must execute the *Load Velocity Override* function again for that axis.



Note Typically, all axes in a vector space should have the same velocity override. If axes have different velocity overrides, the vector move cannot function as expected. This mode is legal however, and will not generate an error.

Once loaded, velocity override remains in effect until changed by another call to this function. All subsequent moves will be at velocities scaled by the most recent override percentage. At power-up reset, velocity override is always reset to 100%.

Velocity override is commonly used in machine tool and other applications to reduce the speed of a programmed motion sequence and can be used to implement a feed hold by setting the value to zero (0). You can directly use a scaled value from an analog input as the velocity override value.

flex_read_dac and flex_read_dac_rtn

Read DAC

Format

status = flex_read_dac (**boardID**, **axisOrDAC**, **returnVector**)

status = flex_read_dac_rtn (**boardID**, **axisOrDAC**, **DACValue**)

Purpose

Reads the commanded DAC output value for an axis.

Parameters

Input

Name	Type	Description
boardID	u8	assigned by Measurement & Automation Explorer
axisOrDAC	u8	axis or DAC to read
returnVector	u8	destination for the return data

Output

Name	Type	Description
DACValue	i16	commanded DAC output value

Parameter Discussion

axisOrDAC is the axis or DAC to read.

returnVector indicates the desired destination for the return data generated by this function. Available returnVectors include return data to the host (0xFF), return data to a variable (0x01 through 0x78), and don't return data (0).



Note The suffix **_rtn** on the function indicates that the data should be returned to the host. When this calling convention is used, no **returnVector** is required.

DACValue is the 16-bit commanded DAC output value from the PID loop, where +32,767 corresponds to +10 V output and -32,768 corresponds to -10 V output.

Using This Function

The *Read DAC* function returns the value of the specified DAC output. When sent to an axis, this function returns the value of the primary DAC mapped to that axis. The signed 16-bit value returned corresponds to the ± 10 V full scale range of the DAC.

This function is used to monitor the output command from the PID loop. When the DAC output is connected to a torque block servo amplifier, you can use this value to calculate motor torque or to monitor the acceleration and deceleration portions of a trajectory to see how close the control loop is to saturating at its maximum torque limits.

When the DAC output is connected to a velocity block servo amplifier, the DAC value read is a direct representation of the instantaneous commanded velocity.

flex_read_dac_limit_status and flex_read_dac_limit_status_rtn

Read DAC Limit Status

Format

`status = flex_read_dac_limit_status (boardID, returnVector)`

`status = flex_read_dac_limit_status_rtn (boardID, positiveStatus, negativeStatus)`

Purpose

Reads the status of the DAC limits.

Parameters

Input

Name	Type	Description
boardID	u8	assigned by Measurement & Automation Explorer
returnVector	u8	destination for the return data

Output

Name	Type	Description
positiveStatus	u8	bitmap of positive DAC limit status
negativeStatus	u8	bitmap of negative DAC limit status

Parameter Discussion

returnVector indicates the desired destination for the return data generated by this function. Available returnVectors include return data to the host (0xFF), return data to a variable (0x01 through 0x78), and don't return data (0).



Note The suffix `_rtn` on the function indicates that the data should be returned to the host. When this calling convention is used, no **returnVector** is required.

positiveStatus is a bitmap of the positive DAC torque limit status.

D7	D6	D5	D4	D3	D2	D1	D0
XXX	DAC 6	DAC 5	DAC 4	DAC 3	DAC 2	DAC 1	XXX

For D1 through D6:

1 = DAC output at positive limit

0 = DAC output below positive limit

negativeStatus is a bitmap of the negative DAC torque limit status.

D7	D6	D5	D4	D3	D2	D1	D0
XXX	DAC 6	DAC 5	DAC 4	DAC 3	DAC 2	DAC 1	XXX

For D1 through D6:

1 = DAC output at negative limit

0 = DAC output above negative limit

Using This Function

The *Read DAC Limit Status* function returns the positive and negative DAC torque limits. Independent DACs that are not mapped to axes do not have torque limits, so those DACs will always return zeros.

A DAC torque limit status is True (1) when the DAC output is saturated at the corresponding limit. This information tells you that the motor is operating at its maximum torque, probably due to an excessively high value of acceleration or deceleration. It can also indicate excessive friction on the axis, a completely stalled motor, or some other system fault.

When an axis is active (not in the killed, motor off state), this function returns the instantaneous state of the torque limit circuits. If the axis trips out on following error (a typical occurrence when operating at the torque limits), the DAC limit status is latched so you can tell which limit, positive or negative, caused the following error trip. The status remains latched until the axis is activated again by a *Start Motion*, *Stop Motion*, or *Blend Motion* function.

flex_read_steps_gen and flex_read_steps_gen_rtn

Read Steps Generated

Format

status = flex_read_steps_gen (boardID, axisOrStepperOutput, returnVector)

status = flex_read_steps_gen_rtn (boardID, axisOrStepperOutput, steps)

Purpose

Reads the number of steps generated by a stepper output.

Parameters

Input

Name	Type	Description
boardID	u8	assigned by Measurement & Automation Explorer
axisOrStepperOutput	u8	axis or stepper output to read
returnVector	u8	destination for the return data

Output

Name	Type	Description
steps	i32	number of steps generated

Parameter Discussion

axisOrStepperOutput is the axis or stepper output to read.

returnVector indicates the desired destination for the return data generated by this function. Available returnVectors include return data to the host (0xFF), return data to a variable (0x01 through 0x78), and don't return data (0).



Note The suffix `_rtn` on the function indicates that the data should be returned to the host. When this calling convention is used, no **returnVector** is required.

steps is the number of steps generated since the stepper axis last had its position reset.

Using This Function

The *Read Steps Generated* function returns the number of steps generated by a stepper axis or stepper output resource. For open-loop stepper axes, this function returns exactly the same value as the *Read Position* function.

For closed-loop stepper axes, this function returns the actual number of steps generated while the *Read Position* function returns the feedback position converted from counts to steps. The number of steps generated will include extra steps added during any pull-in move required to reach the target position.

In applications where the feedback resolution is less than the steps resolution, the steps generated can also be more a more accurate measurement of position.

flex_read_target_pos and flex_read_target_pos_rtn

Read Target Position

Format

status = flex_read_target_pos (boardID, axis, returnVector)

status = flex_read_target_pos_rtn (boardID, axis, targetPosition)

Purpose

Reads the destination position of the current motion trajectory.

Parameters

Input

Name	Type	Description
boardID	u8	assigned by Measurement & Automation Explorer
axis	u8	axis to be read
returnVector	u8	destination for the return data

Output

Name	Type	Description
targetPosition	i32	destination position of the current motion trajectory in counts or steps

Parameter Discussion

axis is the axis to be read.

returnVector indicates the desired destination for the return data generated by this function. Available returnVectors include return data to the host (0xFF), return data to a variable (0x01 through 0x78), and don't return data (0).



Note The suffix `_rtn` on the function indicates that the data should be returned to the host. When this calling convention is used, no **returnVector** is required.

targetPosition is the destination position of the current motion trajectory in counts (servo axes) or steps (stepper axes).

Using This Function

The *Read Target Position* function returns the destination position of the motion trajectory currently in process. If the axis is stopped, it returns the target position of last trajectory completed.

This function differs from the *Reset Position* function in that it returns the commanded target (destination) position rather than the actual feedback position. When blending moves, this function will return a value that is different from the last loaded target position when the blend has not occurred yet.

You can use this function to monitor the state of an onboard program as it sequences moves. It returns the target position of the move segment in process.

flex_read_trajectory_data and flex_read_trajectory_data_rtn

Read Trajectory Data

Format

status = flex_read_trajectory_data (boardID, returnVector)

status = flex_read_trajectory_data_rtn (boardID, returnData)

Purpose

Reads a sample of acquired data from the samples buffer.

Parameters

Input

Name	Type	Description
boardID	u8	assigned by Measurement & Automation Explorer
returnVector	u8	destination for the return data

Output

Name	Type	Description
returnData	[i32]	Array of position and velocity data for selected axes

Parameter Discussion

returnVector indicates the desired destination for the return data generated by this function. Available returnVectors include return data to the host (0xFF), return data to a variable (0x01 through 0x78), and don't return data (0).



Note The suffix `_rtn` on the function indicates that the data should be returned to the host. When this calling convention is used, no **returnVector** is required.

returnData is an array of position and velocity data for the selected axes. The size of the **returnData** array depends upon the number of axes selected with the *Acquire Trajectory Data* function. For each axis selected, this function returns two array elements, position in counts (steps) and velocity in counts/s (steps/s). The maximum array size is 12, when all 6 axes are selected.

Using This Function

The *Read Trajectory Data* function is used to read back a single sample of acquired data from the onboard sample buffer. The number of samples, the time between samples and the size of each sample is set when you execute the *Acquire Trajectory Data* function. The sample buffer operates first-in-first-out (FIFO), so multiple calls to this function return samples in their correct time sequence.

While it is possible to read the sample buffer while samples are still being acquired, you must wait enough time between calls to the *Read Trajectory Data* function to avoid emptying the buffer.



Note Attempting to read an empty sample buffer will generate an error. For information about errors and error handling, refer to Chapter 4, *Software Overview*.

The *Acquire Trajectory Data* and *Read Trajectory Data* functions are used to acquire and read back time-sampled position and velocity data for analysis and display. These functions implement a digital oscilloscope that is useful during system setup, PID tuning, and general motion with data acquisition synchronization.

Example

The *Acquire Trajectory Data* function is executed with axes 1, 2, and 5 selected. Each call to the *Read Trajectory Data* function returns one sample with an array size of six and the following data in the array:

```
returnData[] = {Axis 1 position, Axis 1 velocity,  
                Axis 2 position, Axis 2 velocity  
                Axis 5 position, Axis 5 velocity }
```

Start & Stop Motion Functions

This chapter contains detailed descriptions of the functions used to start, blend, and stop motion. The functions are arranged alphabetically by function name.

You can execute all of the FlexMotion start and stop functions on an individual axis, simultaneously on multiple axes, on a vector space, or simultaneously on multiple vector spaces. These functions give complete control over the state of the motors in the system and with the addition of the *Find Home* and *Find Index* programs, are the only FlexMotion functions that can actually initiate motion.

As a quick reference, a summary of the entire FlexMotion function API is in Appendix B, *FlexMotion Functions*.

flex_blend

Blend Motion

Format

status = flex_blend (boardID, axisOrVectorSpace, axisOrVSMMap)

Purpose

Blends motion on a single axis, single vector space, multiple axes, or multiple vector spaces.

Parameters

Input

Name	Type	Description
boardID	u8	assigned by Measurement & Automation Explorer
axisOrVectorSpace	u8	axis or vector space selector
axisOrVSMMap	u16	bitmap of axes or vector spaces to blend

Parameter Discussion

axisOrVectorSpace can select an axis (1 through 6), vector space (0x11 through 0x13), multiple axes (0), or multiple vector spaces (0x10). When simultaneously blending multiple axes or vector spaces, the **axisOrVSMMap** parameter indicates which axes or vector spaces are involved.

axisOrVSMMap is the bitmap of axes or vector spaces to be blended. It is only required when you select multiple axes or vector spaces with the **axisOrVectorSpace** parameter.

When blending axes (**axisOrVectorSpace** = 0):

D15	D14	D13	D12	D11	D10	D9	D8	D7	D6	D5	D4	D3	D2	D1	D0
0	0	0	0	0	0	0	0	0	Axis 6	Axis 5	Axis 4	Axis 3	Axis 2	Axis 1	0

For D1 through D6:

1 = Blend axis

0 = Do not blend axis

When blending vector spaces (**axisOrVectorSpace** = 0x10):

D15	D14	D13	D12	D11	D10	D9	D8	D7	D6	D5	D4	D3	D2	D1	D0
0	0	0	0	0	0	0	0	0	0	0	0	VS 3	VS 2	VS 1	0

For D1 through D3:

1 = Blend vector space

0 = Do not blend vector space

To blend a single axis or vector space, set the **axisOrVectorSpace** selector to the desired axis or vector space. The **axisOrVSMaP** bitmap is ignored.

To blend multiple axes, the **axisOrVectorSpace** selector is set to 0 (zero) and the **axisOrVSMaP** bitmap defines the axes to be blended. Similarly, to blend multiple vector spaces, the **axisOrVectorSpace** selector is set to 0x10 and the **axisOrVSMaP** bitmap defines the vector spaces to be blended.



Note It is not possible to combine the blend of an axis and the blend of a vector space in a single use of this function. To accomplish this, create a single axis vector space and then execute a multi-vector space blend.

Using This Function

The *Blend Motion* function is used to blend motion profiles on axes or vector spaces, either simultaneously or individually. A blend is similar to a normal start and has the same requirements for valid trajectory parameters as the *Start Motion* function. The blended move uses the most recently loaded values of acceleration, velocity, target position, s-curve, operation mode and so on to generate the motion profile.



Note If a stepper axis is in a killed state (not energized), halt the axis using the *Stop Motion* function, with **stopType** set to NIMC_HALT_STOP, before you execute a *Start Motion* or *Blend Motion* function. After you halt the axis, you might need to wait before executing a *Start Motion* or *Blend Motion* function, so that the stepper drive comes out of reset state. If the stepper drive does not come out of reset state before you execute the function, the stepper axis might lose some steps during acceleration. To determine whether you need to wait before executing the function, refer to your stepper drive documentation or vendor.

The primary difference between a *Start Motion* function and a *Blend Motion* function is that the *Start Motion* is immediate and preemptive, while *Blend Motion* waits and starts the next move upon the completion of the previous move.

Blend starting smoothly blends two move segments on an axis, axes, or vector space(s). There are three types of blends, controlled by the blend factor:

- Blend moves by superimposing the deceleration profile of the previous move with the acceleration profile of the next move (blend factor = -1).
- Blend moves by starting the next move at the exact point when the previous move has stopped (blend factor = 0).
- Start the next move after a programmed delay time between the end of the previous move and the start of the next move (blend factor > 0 ms).

Refer to the [Load Blend Factor](#) function for more information on how blend factor controls the blending of motion profiles.



Caution For sequencing multiple moves with blends, FlexMotion must complete one blend before parameters for the next move are loaded. Refer to the [Read Blend Status](#) function for more information on blend sequencing.

If motion on any axis involved in a blend is illegal due to a limit or other error condition, the entire [Blend Motion](#) function will not be executed and a modal error is generated. None of the axes are affected and the move(s) in process will complete normally and stop. For information about errors and error handling, refer to Chapter 4, [Software Overview](#).

Example 1

To blend motion on axis 4 only, call the [Blend Motion](#) function with the following parameters:

axisOrVectorSpace = 4
axisOrVSMMap = Don't care

Example 2

To blend motion on vector spaces 2 and 3, call the [Blend Motion](#) function with the following parameters:

axisOrVectorSpace = 0x10
axisOrVSMMap = 0xC

The **axisOrVSMMap** value of 0x0C corresponds to the following bitmap.

D15	D14	D13	D12	D11	D10	D9	D8	D7	D6	D5	D4	D3	D2	D1	D0
0	0	0	0	0	0	0	0	0	0	0	0	VS 3	VS 2	VS 1	0
0	0	0	0	0	0	0	0	0	0	0	0	1	1	0	0

flex_start

Start Motion

Format

status = flex_start (boardID, axisOrVectorSpace, axisOrVSMap)

Purpose

Starts motion on a single axis, single vector space, multiple axes, or multiple vector spaces.

Parameters

Input

Name	Type	Description
boardID	u8	assigned by Measurement & Automation Explorer
axisOrVectorSpace	u8	axis or vector space selector
axisOrVSMap	u16	bitmap of axes or vector spaces to start

Parameter Discussion

axisOrVectorSpace can select an axis (1 through 6), vector space (0x11 through 0x13), multiple axes (0), or multiple vector spaces (0x10). When simultaneously starting multiple axes or vector spaces, the **axisOrVSMap** parameter indicates which axes or vector spaces are involved.

axisOrVSMap is the bitmap of axes or vector spaces to be started. It is only required when multiple axes or vector spaces are selected with the **axisOrVectorSpace** parameter.

When starting axes (**axisOrVectorSpace** = 0):

D15	D14	D13	D12	D11	D10	D9	D8	D7	D6	D5	D4	D3	D2	D1	D0
0	0	0	0	0	0	0	0	0	Axis 6	Axis 5	Axis 4	Axis 3	Axis 2	Axis 1	0

For D1 through D6:

1 = Start axis

0 = Do not start axis

When starting vector spaces (**axisOrVectorSpace** = 0x10):

D15	D14	D13	D12	D11	D10	D9	D8	D7	D6	D5	D4	D3	D2	D1	D0
0	0	0	0	0	0	0	0	0	0	0	0	VS 3	VS 2	VS 1	0

For D1 through D3:

1 = Start vector space

0 = Do not start vector space

To start a single axis or vector space, set the **axisOrVectorSpace** selector to the desired axis or vector space. The **axisOrVSMMap** bitmap is ignored.

To start multiple axes, the **axisOrVectorSpace** selector is set to 0 (zero) and the **axisOrVSMMap** bitmap defines the axes to be started. Similarly, to start multiple vector spaces, the **axisOrVectorSpace** selector is set to 0x10 and the **axisOrVSMMap** bitmap defines the vector spaces to be started.



Note It is not possible to combine the start of an axis and the start of a vector space in a single use of this function. To accomplish this, create a single axis vector space and then execute a multi-vector space start.

Using This Function

The *Start Motion* function is used to start a motion profile on axes or vector spaces, either simultaneously or individually. A start is preemptive and uses the most recently loaded values of acceleration, velocity, target position, s-curve, operation mode, and so on to generate the motion profile.



Note If a stepper axis is in a killed state (not energized), halt the axis using the *Stop Motion* function, with **stopType** set to NIMC_HALT_STOP, before you execute a *Start Motion* or *Blend Motion* function. After you halt the axis, you might need to wait before executing a *Start Motion* or *Blend Motion* function, so that the stepper drive comes out of reset state. If the stepper drive does not come out of reset state before you execute the function, the stepper axis might lose some steps during acceleration. To determine whether you need to wait before executing the function, refer to your stepper drive documentation or vendor.

You can also use the *Start Motion* function to update trajectory parameters to a move that is already in process. Trajectory parameters loaded after the start take effect immediately upon the next start without requiring the motion to come to a stop. You can use this feature for velocity profiling and other continuous motion applications.

Motion will start on properly configured and enabled axes. If motion on any axis involved in a start is illegal due to a limit or other error condition, the entire *Start Motion* function is not executed and a modal error is generated. None of the axes are started or updated. For information about errors and error handling, refer to Chapter 4, *Software Overview*.

Example 1

To execute a multi-axis start on axes 2 and 6, call the *Start Motion* function with the following parameters:

axisOrVectorSpace = 0

axisOrVSMap = 0x44

The **axisOrVSMap** value of 0x44 corresponds to the following bitmap.

D15	D14	D13	D12	D11	D10	D9	D8	D7	D6	D5	D4	D3	D2	D1	D0
0	0	0	0	0	0	0	0	0	Axis 6	Axis 5	Axis 4	Axis 3	Axis 2	Axis 1	0
0	0	0	0	0	0	0	0	0	1	0	0	0	1	0	0

Example 2

To start motion on vector space 2, call the *Start Motion* function with the following parameters:

axisOrVectorSpace = 0x12

axisOrVSMap = Don't care

flex_stop_motion

Stop Motion

Format

status = flex_stop_motion (boardID, axisOrVectorSpace, stopType, axisOrVSMMap)

Purpose

Stops motion on a single axis, single vector space, multiple axes, or multiple vector spaces. Three types of stops can be executed: decelerate to stop, halt stop, and kill stop.

Parameters

Input

Name	Type	Description
boardID	u8	assigned by Measurement & Automation Explorer
axisOrVectorSpace	u8	axis or vector space selector
stopType	u16	type of stop to execute
axisOrVSMMap	u16	bitmap of axes or vector spaces to stop

Parameter Discussion

axisOrVectorSpace can select an axis (1 through 6), vector space (0x11 through 0x13), multiple axes (0), or multiple vector spaces (0x10). When simultaneously stopping multiple axes or vector spaces, the **axisOrVSMMap** parameter indicates which axes or vector spaces are involved.

stopType is the type of stop to execute.

stopType Constant	stopType Value	Action
NIMC_DECEL_STOP	0	decelerate smoothly to a stop
NIMC_HALT_STOP	1	immediate, full torque/stop
NIMC_KILL_STOP	2	zero the command and activate the inhibit/output

axisOrVSMMap is the bitmap of axes or vector spaces to be stopped. It is only required when multiple axes or vector spaces are selected with the **axisOrVectorSpace** parameter.

When stopping axes (**axisOrVectorSpace** = 0):

D15	D14	D13	D12	D11	D10	D9	D8	D7	D6	D5	D4	D3	D2	D1	D0
0	0	0	0	0	0	0	0	0	Axis 6	Axis 5	Axis 4	Axis 3	Axis 2	Axis 1	0

For D1 through D6:

1 = Stop axis

0 = Do not stop axis

When stopping vector spaces (**axisOrVectorSpace** = 0x10):

D15	D14	D13	D12	D11	D10	D9	D8	D7	D6	D5	D4	D3	D2	D1	D0
0	0	0	0	0	0	0	0	0	0	0	0	VS 3	VS 2	VS 1	0

For D1 through D3:

1 = Stop vector space

0 = Do not stop vector space

To stop a single axis or vector space, set the **axisOrVectorSpace** selector to the desired axis or vector space. The **axisOrVSMMap** bitmap is ignored.

To stop multiple axes, the **axisOrVectorSpace** selector is set to 0 (zero) and the **axisOrVSMMap** bitmap defines the axes to be stopped. Similarly, to stop multiple vector spaces, the **axisOrVectorSpace** selector is set to 0x10 and the **axisOrVSMMap** bitmap defines the vector spaces to be stopped.



Note It is not possible to combine the stop of an axis and the stop of a vector space in a single use of this function. To accomplish this, create a single axis vector space and then execute a multi-vector space stop.

Using This Function

The *Stop Motion* function is used to stop a motion profile on axes or vector spaces, either simultaneously or individually.

You can execute three different types of stops with the *Stop Motion* function: decel stop, halt stop, and kill stop. When a decel stop is executed (NIMC_DECEL_STOP), the axis, axes, or vector space(s) will immediately begin to follow the deceleration portion of their trajectory

profile as controlled by previously loaded deceleration and s-curve parameters. The actual stopped position is therefore dependent upon this deceleration trajectory.

In contrast, a halt stop (NIMC_HALT_STOP) is immediate and abrupt. The target position is set to the position of the axis at the moment the function is executed. On servo axes, full torque is applied to stop the motor(s) as quickly as possible. On stepper axes, the step pulses are immediately ceased. In both cases, FlexMotion attempts to stop the motor(s) with a near infinite rate of deceleration. There is no trajectory profile and motion is not controlled by previously loaded deceleration and s-curve parameters.

On servo axes, a kill stop (NIMC_KILL_STOP) disables the control loop and zeros the output DAC, allowing frictional forces alone to stop the motion. On stepper axes, a kill stop immediately ceases the stepper pulse generation. On both axis types, there is no trajectory profile during a kill stop. If enabled, the inhibit output is activated to inhibit (disable) the servo amplifier or stepper driver. You can enable the inhibit outputs and set their polarity as active-high (noninverting) or active-low (inverting) with the *Configure Inhibit Outputs* function.



Warning When an axis is killed, the motor is allowed to *freewheel*, and could possibly move if external forces are acting on it. If the axis moves into an enabled limit switch, the axis will be energized and held in position. If you do not want the axis to become energized under any circumstances, you should disable the axis after killing it.

The *Stop Motion* function may or may not affect the motion of other axes that are not explicitly referenced in the function. If an axis that is part of a vector space is individually killed, the other axes in the vector space are decel stopped. If a slave axis is killed, master-slave gearing is automatically disabled. Finally, if a program attempts to start axes that have been manually stopped by the host computer, it is overruled and put into the paused state.

Example 1

To execute a multi-axis kill stop on all axes, call the *Stop Motion* function with the following parameters:

```
axisOrVectorSpace = 0
stopType = NIMC_KILL_STOP
axisOrVSMap = 0x7E
```

The **axisOrVSMap** value of 0x7E corresponds to the following bitmap.

D15	D14	D13	D12	D11	D10	D9	D8	D7	D6	D5	D4	D3	D2	D1	D0
0	0	0	0	0	0	0	0	0	Axis 6	Axis 5	Axis 4	Axis 3	Axis 2	Axis 1	0
0	0	0	0	0	0	0	0	0	1	1	1	1	1	1	0

Example 2

To decelerate stop motion on vector space 1, call the *Stop Motion* function with the following parameters:

axisOrVectorSpace = 0x11

stopType = NIMC_DECEL_STOP

axisOrVSMap = Don't care

Motion I/O Functions

This chapter contains detailed descriptions of functions used to setup and control the motion I/O features of the FlexMotion controller. It includes functions to set polarity and enable limit and home inputs, high-speed capture inputs and inhibit outputs, functions to configure and control breakpoint outputs, and functions to read the status of all the motion I/O signals, high-speed captured position, and software limit status. The functions are arranged alphabetically by function name.

All of the dedicated motion I/O can also function as general-purpose digital I/O when it is not being used for its motion specific features. You can set and reset outputs, you can read inputs at any time, and you can set and change their polarity as required.

This chapter has a main section covering limits and other basic Motion I/O functions, and two subsections, one on *Breakpoint Functions* and the other on *High-Speed Capture Functions*.

As a quick reference, a summary of the entire FlexMotion function API is in Appendix B, *FlexMotion Functions*.

flex_configure_inhibits

Configure Inhibit Outputs

Format

status = flex_configure_inhibits (**boardID**, **axisMap**, **polarityMap**)

Purpose

Sets polarity and enables the per-axis inhibit outputs.

Parameters

Input

Name	Type	Description
boardID	u8	assigned by Measurement & Automation Explorer
axisMap	u8	bitmap of inhibit outputs to enable
polarityMap	u8	bitmap of active polarities for the inhibit outputs

Parameter Discussion

axisMap is the bitmap of inhibit outputs to enable. An enabled inhibit follows the motor off (killed) state of the axis.

D7	D6	D5	D4	D3	D2	D1	D0
0	Axis 6	Axis 5	Axis 4	Axis 3	Axis 2	Axis 1	0

For D1 through D6:

1 = Inhibit enabled (default)

0 = Inhibit disabled

polarityMap is the bitmap of active polarities for the inhibit outputs.

D7	D6	D5	D4	D3	D2	D1	D0
0	Inhibit 6	Inhibit 5	Inhibit 4	Inhibit 3	Inhibit 2	Inhibit 1	0

For D1 through D6:

1 = Inverting (default)

0 = Noninverting

Using This Function

The *Configure Inhibit Outputs* function enables/disables and sets the polarity (inverting or noninverting) of the axis inhibit outputs. When enabled, a per-axis inhibit output is linked to the motor off state of the corresponding axis. A killed axis (motor off) forces the corresponding inhibit output On. When the axis is active, the inhibit output is Off.

Inhibit outputs are typically used to disable the servo amplifier or stepper driver for power savings, safety, or specific application reasons.



Note Killing a servo axis also zeros its DAC output. With torque block amplifiers this means that the motor freewheels whether or not the amplifier is disabled. With velocity block servo amplifiers or stepper drivers, the motor does not freewheel unless the amplifier/driver is disabled with the inhibit output.

You can also use inhibit outputs as general-purpose outputs. Disabled inhibit outputs ignore the state of their corresponding axis and can be directly controlled through the *Set Inhibit MOMO* function.

You can configure the active polarity of each inhibit output as inverting or noninverting. Inverting polarity means that a logical True or On state corresponds to an active-low output. Conversely, noninverting polarity means that a logical True (On) corresponds to an active-high output. The inhibit polarity is always in effect, whether the inhibit is linked to its axis (enabled) or directly controlled through the *Set Inhibit MOMO* function.

Example

To configure inhibit outputs 1 and 2 as axis inhibits with inverting polarity and the rest of the inhibit outputs as general-purpose outputs with noninverting polarity, call the *Configure Inhibit Outputs* function with the following parameters:

axisMap = 0x06, which corresponds to the following bitmap

D7	D6	D5	D4	D3	D2	D1	D0
0	Axis 6	Axis 5	Axis 4	Axis 3	Axis 2	Axis 1	0
0	0	0	0	0	1	1	0

polarityMap = 0x06, which corresponds to the following bitmap

D7	D6	D5	D4	D3	D2	D1	D0
0	Inhibit 6	Inhibit 5	Inhibit 4	Inhibit 3	Inhibit 2	Inhibit 1	0
0	0	0	0	0	1	1	0

flex_enable_home_inputs

Enable Home Inputs

Format

status = flex_enable_home_inputs (**boardID**, **homeMap**)

Purpose

Enables/disables the home inputs.

Parameters

Input

Name	Type	Description
boardID	u8	assigned by Measurement & Automation Explorer
homeMap	u16	bitmap of home inputs to enable

Parameter Discussion

homeMap is the bitmap of home inputs to enable.

D15	D14	D13	D12	D11	D10	D9	D8	D7	D6	D5	D4	D3	D2	D1	D0
0	0	0	0	0	0	0	0	0	Home 6	Home 5	Home 4	Home 3	Home 2	Home 1	0

For D1 through D6:

1 = Home input enabled

0 = Home input disabled (default)

Using This Function

The *Enable Home Inputs* function enables/disables any combination of axis home inputs. An enabled home input causes a halt stop on the axis when the input becomes active. You can configure each home input to be active-low (inverting) or active-high (noninverting) with the *Set Home Input Polarity* function. You can also use a home input as a general-purpose input and read its status with the *Read Home Input Status* function.

Home inputs are an enhancement on the FlexMotion controller and are not required for basic motion control. You can operate all motion control functions without enabling or using the home inputs except the *Find Home* function, which requires enabled limit and home inputs for operation.



Note An active (and enabled) home input transition on an axis that is part of a vector space move causes that axis to halt stop and the other axes in the vector space to decelerate to a stop.

Example

To enable the home inputs for axes 2 and 4, call the *Enable Home Inputs* function with **homeMap** = 0x0014, which corresponds to the following bitmap.

D15	D14	D13	D12	D11	D10	D9	D8	D7	D6	D5	D4	D3	D2	D1	D0
0	0	0	0	0	0	0	0	0	Home 6	Home 5	Home 4	Home 3	Home 2	Home 1	0
0	0	0	0	0	0	0	0	0	0	0	1	0	1	0	0

flex_enable_limits

Enable Limits

Format

status = flex_enable_limits (**boardID**, **limitType**, **forwardLimitMap**, **reverseLimitMap**)

Purpose

Enables/disables either the forward and reverse limit inputs or the forward and reverse software position limits.

Parameters

Input

Name	Type	Description
boardID	u8	assigned by Measurement & Automation Explorer
limitType	u16	hardware/software limit selector
forwardLimitMap	u8	bitmap of forward limits to enable
reverseLimitMap	u8	bitmap of reverse limits to enable

Parameter Discussion

limitType selects the type of limit to enable, either the hardware limit switch inputs or the software position limits.

limitType Constant	limitType Value
NIMC_LIMIT_SWITCHES	0
NIMC_SOFTWARE_LIMITS	1

forwardLimitMap is the bitmap of forward limits to enable (either inputs or software).

D7	D6	D5	D4	D3	D2	D1	D0
0	Forward 6	Forward 5	Forward 4	Forward 3	Forward 2	Forward 1	0

For D1 through D6:

1 = Forward limit enabled

0 = Forward limit disabled (default)

reverseLimitMap is the bitmap of reverse limits to enable (either inputs or software).

D7	D6	D5	D4	D3	D2	D1	D0
0	Reverse 6	Reverse 5	Reverse 4	Reverse 3	Reverse 2	Reverse 1	0

For D1 through D6:

1 = Reverse limit enabled

0 = Reverse limit disabled (default)

Using This Function

The *Enable Limits* function enables/disables any combination of axis limits. You can enable the physical limit inputs (hardware) or the logical position limits (software) depending upon the **limitType** selected. You can enable or disable forward and reverse limits separately. You can enable both software and hardware limits on an axis or axes by calling this function twice.

The limit inputs are typically connected to end-of-travel limit switches or sensors. An enabled limit input causes a halt stop on the axis when the input becomes active. You can configure each limit input to be active-low (inverting) or active-high (noninverting) with the *Set Limit Input Polarity* function. Active limit inputs also prohibit attempts to start motion that would cause additional travel in the direction of the limit. You can also use limit inputs as general-purpose inputs and read their status with the *Read Limit Status* function.



Note For the end-of-travel limits to function correctly, the forward limit switch or sensor must be located at the positive (count up) end of travel and the reverse limit at the negative (count down) end of travel.

An active (and enabled) limit input transition on an axis that is part of a vector space move causes that axis to halt stop and the other axes in the vector space to decelerate to a stop.

Similarly, software limits are often used to restrict the range of travel further and avoid ever hitting the hardware limit switches. An enabled software limit causes the axis to smoothly decelerate to a stop when the limit position is reached or exceeded. Even when disabled, you can poll the software limits by the host computer or use an onboard program to warn of an out of range position. For information about loading and reading the forward and reverse software limits, see the *Load Software Limit Positions* and the *Read Limit Status* functions.

Hardware limit inputs and software position limits are enhancements on the FlexMotion controller and are not required for basic motion control. You can operate all motion control functions without enabling or using these limits except the *Find Home* function, which requires enabled limit and home inputs for operation. *Find Home* does not require enabled software limits.



Note If any axis in a vector space move exceeds an enabled software limit position, all axes in the vector space decelerate to a stop.

Example

To enable the forward and reverse software limits on axes 5 and 6, call the *Enable Limits* function with the following parameters:

limitType = NIMC_SOFTWARE_LIMITS

forwardLimitMap = 0x60, which corresponds to the following bitmap

D7	D6	D5	D4	D3	D2	D1	D0
0	Forward 6	Forward 5	Forward 4	Forward 3	Forward 2	Forward 1	0
0	1	1	0	0	0	0	0

reverseLimitMap = 0x60, which corresponds to the following bitmap

D7	D6	D5	D4	D3	D2	D1	D0
0	Reverse 6	Reverse 5	Reverse 4	Reverse 3	Reverse 2	Reverse 1	0
0	1	1	0	0	0	0	0

This function call also disables the forward and reverse software limits on axes 1 through 4. It has no effect on the enable/disable state of the forward and reverse limit switch inputs. You can enable these limit inputs with another call to this function.

flex_load_sw_lim_pos

Load Software Limit Positions

Format

status = flex_load_sw_lim_pos (boardID, axis, forwardLimit, reverseLimit, inputVector)

Purpose

Loads the forward and reverse software limit positions for an axis.

Parameters

Input

Name	Type	Description
boardID	u8	assigned by Measurement & Automation Explorer
axis	u8	axis to be controlled
forwardLimit	i32	forward software limit position in counts or steps
reverseLimit	i32	reverse software limit position in counts or steps
inputVector	u8	source of the data for this function

Parameter Discussion

axis is the axis to be controlled.

forwardLimit is the forward software limit position in counts (servo axes) or steps (stepper axes). Software limit positions can be anywhere within the 32-bit position range, $-(2^{31})$ to $+(2^{31}-1)$. The default value for the forward software limit is $+(2^{30}-1)$ counts (steps).

reverseLimit is the reverse software limit position in counts (servo axes) or steps (stepper axes). Software limit positions can be anywhere within the 32-bit position range, $-(2^{31})$ to $+(2^{31}-1)$. The default value for the reverse software limit is -2^{30} counts (steps).



Note The **forwardLimit** cannot be less than the **reverseLimit**.

inputVector indicates the source of the data for this function. Available inputVectors include immediate (0xFF) or variable (0x01 through 0x78).

Using This Function

The *Load Software Limit Positions* function sets the forward and reverse position limit values for the selected axis. When enabled with the *Enable Limits* function, a software limit causes the axis to smoothly decelerate to a stop when the limit position is reached or exceeded.

Even when disabled, you can poll the software limits by the host computer or use an onboard program to warn of an out of range position. For information about reading the software limit status, see the *Read Limit Status* function.

You can use software limits to implement a position-based simulated limit switch. Software limits are often used to restrict the range of travel and avoid hitting the hardware end-of-travel limit switches. For example, you can travel at a high velocity until hitting the software limit switch, and then move more slowly until hitting the hardware limit switch.



Warning After an axis has stopped due to encountering a software limit switch, you can still move further in the same direction if you command the axis to do so. This behavior is not possible with hardware limits, but is desirable for software limits.

flex_read_home_input_status and flex_read_home_input_status_rtn

Read Home Input Status

Format

`status = flex_read_home_input_status (boardID, returnVector)`

`status = flex_read_home_input_status_rtn (boardID, homeStatus)`

Purpose

Reads the instantaneous status of the home inputs.

Parameters

Input

Name	Type	Description
boardID	u8	assigned by Measurement & Automation Explorer
returnVector	u8	destination for the return data

Output

Name	Type	Description
homeStatus	u16	bitmap of the logical state of the home inputs

Parameter Discussion

returnVector indicates the desired destination for the return data generated by this function. Available returnVectors include return data to the host (0xFF), return data to a variable (0x01 through 0x78), and don't return data (0).



Note The suffix `_rtn` on the function indicates that the data should be returned to the host. When this calling convention is used, no **returnVector** is required.

homeStatus is the bitmap of the logical state of the home inputs.

D15	D14	D13	D12	D11	D10	D9	D8	D7	D6	D5	D4	D3	D2	D1	D0
XXX	XXX	XXX	XXX	XXX	XXX	XXX	XXX	XXX	Home 6	Home 5	Home 4	Home 3	Home 2	Home 1	XXX

For D1 through D6:

1 = Home input True (On)

0 = Home input False (Off)

Using This Function

The *Read Home Input Status* function returns the logical state of the home inputs. You can execute this function at anytime to monitor the home inputs, whether they are enabled or not. A home input enabled with the *Enable Home Inputs* function causes a halt stop on an axis when its home input becomes active (True). You can also use a home input as a general-purpose input and read its status with this function.



Note This function reads the logical state (On or Off, True or False) of the home inputs. The polarity of the home inputs determines whether an On state is active-high or active-low. Refer to the *Set Home Input Polarity* function for more information.

flex_read_limit_status and flex_read_limit_status_rtn

Read Limit Status

Format

`status = flex_read_limit_status (boardID, limitType, returnVector)`

`status = flex_read_limit_status_rtn (boardID, limitType, forwardLimitStatus, reverseLimitStatus)`

Purpose

Reads the instantaneous state of either the hardware limit inputs or the software limits.

Parameters

Input

Name	Type	Description
<code>boardID</code>	u8	assigned by Measurement & Automation Explorer
<code>limitType</code>	u16	hardware/software limit selector
<code>returnVector</code>	u8	destination for the return data

Output

Name	Type	Description
<code>forwardLimitStatus</code>	u8	bitmap of forward limit status
<code>reverseLimitStatus</code>	u8	bitmap of reverse limit status

Parameter Discussion

`limitType` selects the type of limit status to read, either the hardware limit switch status or the software position limit status.

limitType Constant	limitType Value
<code>NIMC_LIMIT_SWITCHES</code>	0
<code>NIMC_SOFTWARE_LIMITS</code>	1

returnVector indicates the desired destination for the return data generated by this function. Available returnVectors include return data to the host (0xFF), return data to a variable (0x01 through 0x78), and don't return data (0).



Note The suffix `_rtn` on the function indicates that the data should be returned to the host. When this calling convention is used, no **returnVector** is required.

forwardLimitStatus is the bitmap of forward limit status (either hardware or software).

D7	D6	D5	D4	D3	D2	D1	D0
0	Forward 6	Forward 5	Forward 4	Forward 3	Forward 2	Forward 1	0

For D1 through D6:

- 1 = Forward limit True (On)
- 0 = Forward limit False (Off)

reverseLimitStatus is the bitmap of reverse limit status (either hardware or software).

D7	D6	D5	D4	D3	D2	D1	D0
0	Reverse 6	Reverse 5	Reverse 4	Reverse 3	Reverse 2	Reverse 1	0

For D1 through D6:

- 1 = Reverse limit True (On)
- 0 = Reverse limit False (Off)

Using This Function

The *Read Limit Status* function returns either the hardware limit input status or the software position limit status, depending on the limit type selected. When **limitType** = `NIMC_LIMIT_SWITCHES` (0), this function returns the logical state of the forward and reverse limit inputs.



Note The polarity of the limit inputs determines whether an On state is active-high or active-low. Refer to the *Set Limit Input Polarity* function for more information.

Alternatively, when **limitType** = `NIMC_SOFTWARE_LIMITS` (1), this function returns the state of the forward and reverse software limits. A True (On) indicates that the forward or reverse limit position for the corresponding axis has been reached or exceeded.

You can read the status of the limit inputs and the software position limits at any time, whether the limits are enabled or not. Enabled limits cause axes to stop when their state transitions True. Refer to the *Enable Limits* function for more information.

flex_set_home_polarity

Set Home Input Polarity

Format

status = flex_set_home_polarity (boardID, homePolarityMap)

Purpose

Sets the polarity of the home inputs as either inverting (active-low) or noninverting (active-high).

Parameters

Input

Name	Type	Description
boardID	u8	assigned by Measurement & Automation Explorer
homePolarityMap	u16	bitmap of active polarities for the home inputs

Parameter Discussion

homePolarityMap is the bitmap of active polarities for the home inputs.

D15	D14	D13	D12	D11	D10	D9	D8	D7	D6	D5	D4	D3	D2	D1	D0
0	0	0	0	0	0	0	0	0	Home 6	Home 5	Home 4	Home 3	Home 2	Home 1	0

For D1 through D6:

1 = Inverting (default)

0 = Noninverting

Using This Function

The *Set Home Input Polarity* function defines the active polarity for each home input as either inverting or noninverting. Inverting polarity means that an active-low input corresponds to a logical True or On state. Conversely, noninverting polarity means that an active-high input corresponds to a logical True (On) state.

You can enable home inputs to cause halt stops when the input becomes active with the *Enable Home Inputs* function. You can also use a home input as a general-purpose input and read its status with the *Read Home Input Status* function.

Example

To set the polarity of the home inputs on axes 1, 3, 4, and 5 as inverting and the home inputs on axes 2 and 6 as noninverting, call the *Set Home Input Polarity* function with **homePolarityMap** = 0x003A, which corresponds to the following bitmap.

D15	D14	D13	D12	D11	D10	D9	D8	D7	D6	D5	D4	D3	D2	D1	D0
0	0	0	0	0	0	0	0	0	Home 6	Home 5	Home 4	Home 3	Home 2	Home 1	0
0	0	0	0	0	0	0	0	0	0	1	1	1	0	1	0

flex_set_inhibit_momo

Set Inhibit MOMO

Format

status = flex_set_inhib_momo (boardID, mustOn, mustOff)

Purpose

Sets the inhibit outputs using the MustOn/MustOff protocol.

Parameters

Input

Name	Type	Description
boardID	u8	assigned by Measurement & Automation Explorer
mustOn	u8	bitmap of inhibit outputs to be forced on
mustOff	u8	bitmap of inhibit outputs to be forced off

Parameter Discussion

mustOn is the bitmap of inhibit outputs to be forced on.

D7	D6	D5	D4	D3	D2	D1	D0
0	mustOn 6	mustOn 5	mustOn 4	mustOn 3	mustOn 2	mustOn 1	0

For D1 through D6:

1 = Inhibit output forced On

0 = Inhibit output unchanged (default)

mustOff is the bitmap of inhibit outputs to be forced off.

D7	D6	D5	D4	D3	D2	D1	D0
0	mustOff 6	mustOff 5	mustOff 4	mustOff 3	mustOff 2	mustOff 1	0

For D1 through D6:

1 = Inhibit output forced Off

0 = Inhibit output unchanged (default)

Using This Function

The *Set Inhibit MOMO* function controls disabled inhibit outputs being used as general-purpose I/O. You can directly set the inhibit outputs to a logical On or Off state.



Note This function has no effect on enabled inhibit outputs. These outputs are directly controlled by their corresponding axes.

Using the MustOn/MustOff protocol allows you to set or reset individual inhibit outputs without affecting the other inhibit outputs. This gives you tri-state control over each output: On, Off, or Unchanged. A one (1) in a bit location of the MustOn bitmap turns the inhibit On, while a one (1) in the corresponding location of the MustOff bitmap turns the inhibit Off. A zero (0) in either bitmap has no affect, so leaving both the MustOn and MustOff bits at zero is effectively a hold, and the state of the inhibit output is unchanged. If you set both the MustOn and MustOff bits to one (1), it is interpreted as a MustOn condition and the inhibit is turned On.



Note This function sets the logical state of an inhibit output On or Off (True or False). The polarity of the inhibit outputs determine whether an On state is active-high or active-low. Refer to the *Configure Inhibit Outputs* function for more information.

The *Set Inhibit MOMO* function allows individual control of the inhibit outputs without requiring a shadow value to remember the state of other outputs not being set or reset with the function.

Example

To turn inhibit output 1 On, output 6 off, and leave inhibit outputs 2 through 5 unchanged, call the *Set Inhibit MOMO* function with the following parameters:

mustOn = 0x02, which corresponds to the following bitmap

D7	D6	D5	D4	D3	D2	D1	D0
0	mustOn 6	mustOn 5	mustOn 4	mustOn 3	mustOn 2	mustOn 1	0
0	0	0	0	0	0	1	0

mustOff = 0x40, which corresponds to the following bitmap

D7	D6	D5	D4	D3	D2	D1	D0
0	mustOff 6	mustOff 5	mustOff 4	mustOff 3	mustOff 2	mustOff 1	0
0	1	0	0	0	0	0	0

flex_set_limit_polarity

Set Limit Input Polarity

Format

status = flex_set_limit_polarity (boardID, forwardPolarityMap, reversePolarityMap)

Purpose

Sets the polarity of the forward and reverse limit inputs as either inverting (active-low) or noninverting (active-high).

Parameters

Input

Name	Type	Description
boardID	u8	assigned by Measurement & Automation Explorer
forwardPolarityMap	u8	bitmap of active polarities for the forward limits
reversePolarityMap	u8	bitmap of active polarities for the reverse limits

Parameter Discussion

forwardPolarityMap is the bitmap of active polarities for the forward limit inputs.

D7	D6	D5	D4	D3	D2	D1	D0
0	Forward 6	Forward 5	Forward 4	Forward 3	Forward 2	Forward 1	0

For D1 through D6:

1 = Inverting (default)

0 = Noninverting

reversePolarityMap is the bitmap of active polarities for the reverse limit inputs.

D7	D6	D5	D4	D3	D2	D1	D0
0	Reverse 6	Reverse 5	Reverse 4	Reverse 3	Reverse 2	Reverse 1	0

For D1 through D6:

1 = Inverting (default)

0 = Noninverting

Using This Function

The *Set Limit Input Polarity* function defines the active polarity for each forward and reverse limit input as either inverting or noninverting. Inverting polarity means that an active-low input corresponds to a logical True or On state. Conversely, noninverting polarity means that an active-high input corresponds to a logical True (On) state.

You can enable limit inputs to cause halt stops when the input becomes active with the *Enable Limits* function. You can also use a limit input as a general-purpose input and read its status with the *Read Limit Status* function.

Example

To set the polarity of the forward and reverse limit inputs on axes 1, 2, 3, and 4 as inverting and the forward and reverse limit inputs on axes 5 and 6 as noninverting, call the *Set Limit Input Polarity* function with the following parameters:

forwardPolarityMap = 0x1E, which corresponds to the following bitmap

D7	D6	D5	D4	D3	D2	D1	D0
0	Forward 6	Forward 5	Forward 4	Forward 3	Forward 2	Forward 1	0
0	0	0	1	1	1	1	0

reversePolarityMap = 0x1E, which corresponds to the following bitmap

D7	D6	D5	D4	D3	D2	D1	D0
0	Reverse 6	Reverse 5	Reverse 4	Reverse 3	Reverse 2	Reverse 1	0
0	0	0	1	1	1	1	0

Breakpoint Functions

This subsection contains detailed descriptions of breakpoint functions. Position breakpoints are an enhancement to the encoder FPGA and are available when the encoders are operating as axis feedback or as independent encoder resources. Breakpoint functionality is available on servo and closed-loop stepper axes that use encoder feedback resources 0x21 through 0x24.

Included in this section are the functions to load, enable, and read the status of position breakpoints. You can also load a breakpoint position modulus. Like all motion I/O, breakpoint outputs can also function as general-purpose outputs with the *Set Breakpoint Output MOMO* function.

These functions are arranged alphabetically by function name. As a quick reference, a summary of the entire FlexMotion function API is in Appendix B, *FlexMotion Functions*.

flex_enable_bp

Enable Breakpoint

Format

status = flex_enable_bp (boardID, axisOrEncoder, enableMode, actionOnBreakpoint)

Purpose

Enables a position breakpoint on an axis or encoder.

Parameters

Input

Name	Type	Description
boardID	u8	assigned by Measurement & Automation Explorer
axisOrEncoder	u8	axis or encoder to be controlled
enableMode	u8	breakpoint mode
actionOnBreakpoint	u8	action to perform when breakpoint reached

Parameter Discussion

axisOrEncoder is the axis or encoder to be controlled. You can enable breakpoints on encoders mapped to axes 1 through 6 or directly on encoders 0x21 through 0x24.



Note Breakpoints are only available on encoders 1 through 4 (resources 0x21 through 0x24).

enableMode is the breakpoint enable mode.

enableMode Constant	enableMode Value
NIMC_BREAKPOINT_OFF	0
NIMC_ABSOLUTE_BREAKPOINT	1
NIMC_RELATIVE_BREAKPOINT	2
NIMC_MODULO_BREAKPOINT	3

actionOnBreakpoint is the action to perform when the breakpoint is reached.

actionOnBreakpoint Constant	actionOnBreakpoint Value
NIMC_NO_CHANGE	0
NIMC_RESET_BREAKPOINT	1
NIMC_SET_BREAKPOINT	2
NIMC_TOGGLE_BREAKPOINT	3

Using This Function

The *Enable Breakpoint* function enables the breakpoint and configures it as an absolute, relative, or modulo position breakpoint. It also defines the action to perform when the breakpoint is reached—leave the breakpoint output unchanged, reset the breakpoint output low, set the breakpoint output high, or toggle the state of breakpoint output.



Note For modulo breakpoints, the magnitude of the breakpoint value must be less than the breakpoint modulus. If this range is exceeded, a modal error is generated when you execute the *Enable Breakpoint* function.

When a breakpoint is enabled, the **enableMode** parameter determines how the previously loaded breakpoint position is interpreted. Absolute breakpoints can be anywhere in the 32-bit position range. Relative breakpoints are relative to the instantaneous encoder position when the breakpoint is enabled. Modulo breakpoints are interpreted within the range of the loaded breakpoint modulus. Refer to the *Load Breakpoint Modulus* function for more information on modulo breakpoints.

When an enabled breakpoint is reached, a breakpoint event occurs. You can use the *Read Breakpoint Status* function to see if a breakpoint has occurred yet or not.

A breakpoint event can also cause the state of the corresponding breakpoint output to change. The **actionOnBreakpoint** parameter selects whether the output goes low, goes high, toggles state, or does not change when the breakpoint event occurs. If the breakpoint output is presently in the state defined by **actionOnBreakpoint**, it is forced to the opposite state when the breakpoint is enabled. This guarantees that the desired transition occurs when the breakpoint is reached.

You can enable only one breakpoint per encoder or axis at a time. Enabled breakpoints act as one-shots. When an enabled breakpoint is reached, the breakpoint is automatically disabled. You must explicitly re-enable the breakpoint to use it again. If you need to disable a previously enabled breakpoint, call this function with **enableMode** = NIMC_BREAKPOINT_OFF (0).



Note Enabled breakpoints are also automatically disabled whenever you execute a *Reset Position* or *Reset Encoder Position* function on the corresponding axis.

Breakpoints are fully functional on independent encoders that are not mapped to axes. In this case, you enable breakpoints directly on the encoder resource itself.

flex_load_bp_modulus

Load Breakpoint Modulus

Format

status = flex_load_bp_modulus (boardID, axisOrEncoder, breakpointModulus, inputVector)

Purpose

Load the breakpoint modulus for a position breakpoint.

Parameters

Input

Name	Type	Description
boardID	u8	assigned by Measurement & Automation Explorer
axisOrEncoder	u8	axis or encoder to be controlled
breakpointModulus	u32	breakpoint modulus in counts
inputVector	u8	source of the data for this function

Parameter Discussion

axisOrEncoder is the axis or encoder to be controlled. You can load **breakpointModulus** on encoders mapped to axes 1 through 6 or directly on encoders 0x21 through 0x24.



Note Breakpoints are only available on encoders 1 through 4 (resources 0x21 through 0x24).

breakpointModulus is the breakpoint modulus value in quadrature counts. The range for modulus is 0 to $2^{31}-1$. A modulus of zero (0) effectively disables the modulo function (default).

inputVector indicates the source of the data for this function. Available inputVectors include immediate (0xFF) or variable (0x01 through 0x78).

Using This Function

The *Load Breakpoint Modulus* function loads a modulus value for the axis or encoder specified. This value is used when you enable a breakpoint in modulo mode. Breakpoint modulus is double-buffered and not actually used until you execute the *Enable Breakpoint* function.

Modulo breakpoints are used in applications that require repetitive breakpoints equally spaced. When using a breakpoint modulus, it is no longer necessary to load ever increasing (or decreasing) breakpoint positions. It is still necessary, however, to re-enable the breakpoint after each use.

FlexMotion-6C Modulo Breakpoints

On FlexMotion-6C controllers, the breakpoint modulus defines repeat periods. When a modulo breakpoint is enabled, the loaded breakpoint position is interpreted with respect to the beginning of the active repeat period for the encoder.

Example

An application requires breakpoints every 2,000 counts starting at 500 counts. To accomplish this, you load a breakpoint position of 500 with the *Load Breakpoint Position* function and a breakpoint modulus of 2,000. The modulus defines repeat periods from 0 to 1,999, 2,000 to 3,999, and so on, and breakpoints at 500, 2,500, 4,500, and so on. (It also defines similar repeat periods in the negative direction: -2,000 to -1, -4,000 to -2,001, and so on with breakpoints at -1,500, -3,500, and so on.)

If the instantaneous encoder position is 2,210 counts when you execute the *Enable Breakpoint* function (in modulo mode), the breakpoint at 2,500 counts is enabled. If you re-enable the breakpoint when the instantaneous encoder position is 3,200, the breakpoint at 2,500 is again enabled because the encoder was still in the 2,000 to 3,999 repeat period.

7344 Modulo Breakpoints

On 7344 controllers, the breakpoint hardware and firmware has been enhanced to support true modulo breakpoints. When you enable a modulo breakpoint on a 7344 controller, two breakpoint positions, one in front and one behind the present encoder position, are enabled. You no longer need to keep track of which repeat period you are in to know which of the two possible breakpoint positions has been enabled.

Example

An application requires breakpoints every 2,000 counts offset at -500 counts: ...-4,500, -2,500, -500, 1,500, 3,500, and so on. To accomplish this, you load a breakpoint position of -500 with the *Load Breakpoint Position* function and a breakpoint modulus of 2,000. If the instantaneous encoder position is 2,210 counts when you execute the *Enable Breakpoint* function (in modulo mode), the breakpoints at 1,500 counts and 3,500 counts are both enabled.

flex_load_pos_bp

Load Breakpoint Position

Format

status = flex_load_pos_bp (boardID, axisOrEncoder, breakpointPosition, inputVector)

Purpose

Loads the breakpoint position for an axis or encoder in counts.

Parameters

Input

Name	Type	Description
boardID	u8	assigned by Measurement & Automation Explorer
axisOrEncoder	u8	axis or encoder to be controlled
breakpointPosition	i32	breakpoint position in counts
inputVector	u8	source of the data for this function

Parameter Discussion

axisOrEncoder is the axis or encoder to be controlled. You can load **breakpointPosition** on encoders mapped to axes 1 through 6 or directly on encoders 0x21 through 0x24.



Note Breakpoints are only available on encoders 1 through 4 (resources 0x21 through 0x24).

breakpointPosition is the breakpoint position in quadrature counts. Breakpoint positions can be anywhere within the 32-bit position range, $-(2^{31})$ to $+(2^{31}-1)$. The default value is zero (0).

inputVector indicates the source of the data for this function. Available inputVectors include immediate (0xFF) or variable (0x01 through 0x78).

Using This Function

The *Load Breakpoint Position* function loads the breakpoint position value for the axis or encoder specified. You can specify position breakpoints as either absolute, relative, or with respect to a modulus range when the breakpoint is enabled. Breakpoint position is double-buffered and not actually used until you execute the *Enable Breakpoint* function.



Note For modulo breakpoints, the magnitude of the breakpoint value must be less than the breakpoint modulus. If this range is exceeded, a modal error is generated when you execute the *Enable Breakpoint* function.

When the breakpoint position is reached, a breakpoint event is generated and the associated high-speed breakpoint output immediately transitions.

High-speed breakpoint functionality is performed by the encoder resources themselves. When this function is sent to an axis, it is actually being sent to the mapped encoder resource. Breakpoints are only available on the FPGA encoder resources (0x21 through 0x24) and are always loaded in quadrature counts.

When the same breakpoint position is used on a repetitive basis, it is not necessary to reload the position each time. It is necessary, however, to re-enable the breakpoint after each use.

flex_read_breakpoint_status and flex_read_breakpoint_status_rtn

Read Breakpoint Status

Format

status = flex_read_breakpoint_status (boardID, axisOrEncoder, breakpointType, returnVector)
 status = flex_read_breakpoint_status_rtn (boardID, axisOrEncoder, breakpointType, breakpointStatus)

Purpose

Reads the breakpoint status for all axes or encoders.

Parameters

Input

Name	Type	Description
boardID	u8	assigned by Measurement & Automation Explorer
axisOrEncoder	u8	axis or encoder selector
breakpointType	u16	reserved (must be 0)
returnVector	u8	destination for the return data

Output

Name	Type	Description
breakpointStatus	u16	bitmap of breakpoint status

Parameter Discussion

axisOrEncoder is the axis or encoder selector. For multi-axis status, use 0 (zero). For multi-encoder status, use 0x20.

breakpointType is a reserved input that must be set to NIMC_POSITION_BREAKPOINT (0).

returnVector indicates the desired destination for the return data generated by this function. Available returnVectors include return data to the host (0xFF), return data to a variable (0x01 through 0x78), and don't return data (0).



Note The suffix `_rtn` on the function indicates that the data should be returned to the host. When this calling convention is used, no **returnVector** is required.

breakpointStatus is the bitmap of breakpoint status for all axes or all encoders.

When reading breakpoint status for axes (**axisOrEncoder** = 0):

D15	D14	D13	D12	D11	D10	D9	D8	D7	D6	D5	D4	D3	D2	D1	D0
XXX	XXX	XXX	XXX	XXX	XXX	XXX	XXX	XXX	Axis 6	Axis 5	Axis 4	Axis 3	Axis 2	Axis 1	XXX

For D1 through D6:

1 = Breakpoint occurred

0 = Breakpoint pending or never enabled

When reading breakpoint status for encoders (**axisOrEncoder** = 0x20):

D15	D14	D13	D12	D11	D10	D9	D8	D7	D6	D5	D4	D3	D2	D1	D0
XXX	XXX	XXX	XXX	XXX	XXX	XXX	XXX	XXX	XXX	XXX	Enc 4	Enc 3	Enc 2	Enc 1	XXX

For D1 through D4:

1 = Breakpoint occurred

0 = Breakpoint pending or never enabled



Note Breakpoints are only available on encoders 1 through 4 (resources 0x21 through 0x24).

Using This Function

The *Read Breakpoint Status* function allows you to see if a breakpoint has occurred or is pending. When you enable a breakpoint, the corresponding status bit is reset to indicate that the breakpoint is pending. When the breakpoint position is reached, its status bit is set to True (1).

Example

Executing the *Read Breakpoint Status* function with **axisOrEncoder** = 0x20 and **breakpointType** = 0 returns **breakpointStatus** = 0x0012, which corresponds to the following bitmap.

D15	D14	D13	D12	D11	D10	D9	D8	D7	D6	D5	D4	D3	D2	D1	D0
XXX	XXX	XXX	XXX	XXX	XXX	XXX	XXX	XXX	XXX	XXX	Enc 4	Enc 3	Enc 2	Enc 1	XXX
0	0	0	0	0	0	0	0	0	0	0	1	0	0	1	0

On encoders 1 and 4, breakpoints have occurred, but on encoders 2 and 3, breakpoints are pending or were never enabled.

flex_set_bp_momo

Set Breakpoint Output MOMO

Format

status = flex_set_bp_momo (boardID, axisOrEncoder, mustOn, mustOff)

Purpose

Sets the breakpoint outputs using the MustOn/MustOff protocol.

Parameters

Input

Name	Type	Description
boardID	u8	assigned by Measurement & Automation Explorer
axisOrEncoder	u8	axis or encoder selector
mustOn	u8	bitmap of breakpoint outputs to be forced On
mustOff	u8	bitmap of breakpoint outputs to be forced Off

Parameter Discussion

axisOrEncoder is the axis or encoder selector. To set breakpoint outputs on multiple axes, use 0 (zero). To set breakpoint outputs on multiple encoder resources, use 0x20.

mustOn is the bitmap of breakpoint outputs to be forced On.

D7	D6	D5	D4	D3	D2	D1	D0
0	mustOn 6	mustOn 5	mustOn 4	mustOn 3	mustOn 2	mustOn 1	0

For D1 through D6:

1 = Breakpoint output forced On

0 = Breakpoint output unchanged (default)

mustOff is the bitmap of breakpoint outputs to be forced Off.

D7	D6	D5	D4	D3	D2	D1	D0
0	mustOff 6	mustOff 5	mustOff 4	mustOff 3	mustOff 2	mustOff 1	0

For D1 through D6:

1 = Breakpoint output forced Off

0 = Breakpoint output unchanged (default)



Note Breakpoints are only available on encoders 1 through 4 (resources 0x21 through 0x24).

Using This Function

The *Set Breakpoint Output MOMO* function directly controls the breakpoint outputs and sets them high or low. You can use this function to set breakpoint outputs to a known state or to control them as general-purpose outputs in non-breakpoint applications.

Breakpoint functionality is performed by the encoder resources themselves. When this function is sent to axes, the FlexMotion firmware consults the mapping of axes to encoders and actually sends the command to the mapped encoder resources. Breakpoints are only available on encoder resources 0x21 through 0x24, so you can only control breakpoint outputs on axes 5 and 6 if these axes are using encoder resources 0x21 through 0x24.

Using the MustOn/MustOff protocol allows you to set or reset individual breakpoint outputs without affecting the other breakpoint outputs. This gives you tri-state control over each output: On, Off, or Unchanged. A one (1) in a bit location of the MustOn bitmap sets the breakpoint high, while a one (1) in the corresponding location of the MustOff bitmap resets the breakpoint low. A zero (0) in either bitmap has no effect, so leaving both the MustOn and MustOff bits at zero is effectively a hold, and the state of the breakpoint output is unchanged. If you set both the MustOn and MustOff bits to one (1), it is interpreted as a MustOn condition and the breakpoint is set high.

High-Speed Capture Functions

This subsection contains detailed descriptions of high-speed capture functions. High-speed capture inputs are an enhancement to the encoder FPGA and are available when the encoders are operating as axis feedback or as independent encoder resources. High-speed capture functionality is available on servo and closed-loop stepper axes.

Included in this section are the functions to enable high-speed capture, read the status and the captured position and set the polarity of the high-speed inputs. The high-speed capture inputs can also function as latching general-purpose inputs. Configure as you would for high-speed capture operation, but ignore the captured position. You can then read the state of the latched inputs.

These functions are arranged alphabetically by function name. As a quick reference, a summary of the entire FlexMotion function API is in Appendix B, *FlexMotion Functions*.

flex_enable_hs_caps

Enable High-Speed Position Capture

Format

status = flex_enable_hs_caps (boardID, axisOrEncoder, captureMap)

Purpose

Enables the high-speed capture inputs.

Parameters

Input

Name	Type	Description
boardID	u8	assigned by Measurement & Automation Explorer
axisOrEncoder	u8	axis or encoder selector
captureMap	u16	bitmap of high-speed capture inputs to enable

Parameter Discussion

axisOrEncoder is the axis or encoder selector. To enable high-speed capture inputs on multiple axes, use 0 (zero). To enable high-speed capture inputs on multiple encoder resources, use 0x20.



Note High-speed capture inputs are only available on encoders 1 through 4 (resources 0x21 through 0x24).

captureMap is the bitmap of high-speed capture inputs to enable.

When enabling axes (**axisOrEncoder** = 0):

D15	D14	D13	D12	D11	D10	D9	D8	D7	D6	D5	D4	D3	D2	D1	D0
0	0	0	0	0	0	0	0	0	Axis 6	Axis 5	Axis 4	Axis 3	Axis 2	Axis 1	0

For D1 through D6:

1 = Capture enabled

0 = Capture disabled (default)

When enabling encoders (**axisOrEncoder** = 0x20):

D15	D14	D13	D12	D11	D10	D9	D8	D7	D6	D5	D4	D3	D2	D1	D0
0	0	0	0	0	0	0	0	0	0	0	Enc 4	Enc 3	Enc 2	Enc 1	0

For D1 through D4:

1 = Capture enable

0 = Capture disabled (default)

Using This Function

The *Enable High-Speed Position Capture* function enables high-speed capture inputs to capture instantaneous encoder position when an input becomes active. The position capture is implemented in the encoder FPGA to reduce capture latency to the sub-100 ns range.

High-speed capture functionality is performed by the encoder resources themselves. When this function is sent to axes, it is actually being sent to the mapped encoder resources. High-speed inputs are only available on the FPGA encoder resources (0x21 through 0x24).

The high-speed inputs have programmable polarity. You can set the active state of the input as active-low (inverting) or active-high (noninverting) with the *Set High-Speed Capture Polarity* function. You can determine the results of the high-speed capture from the *Read High-Speed Capture Status* and *Read Captured Position* functions.

High-speed capture is useful in registration and synchronization applications. You can calculate subsequent moves relative to the captured position. For information about relative-to-capture mode, refer to the *Set Operation Mode* function.



Note Enabling a high-speed capture input when the input is already active captures the position immediately and sets the status bit.

flex_read_cap_pos and flex_read_cap_pos_rtn

Read Captured Position

Format

status = flex_read_cap_pos (boardID, axisOrEncoder, returnVector)

status = flex_read_cap_pos_rtn (boardID, axisOrEncoder, capturedPosition)

Purpose

Reads a captured position value from an axis or encoder.

Parameters

Input

Name	Type	Description
boardID	u8	assigned by Measurement & Automation Explorer
axisOrEncoder	u8	axis or encoder to be read
returnVector	u8	destination for the return data

Output

Name	Type	Description
capturedPosition	i32	position value captured

Parameter Discussion

axisOrEncoder is the axis or encoder to be read.



Note High-speed capture inputs are only available on encoders 1 through 4 (resources 0x21 through 0x24).

returnVector indicates the desired destination for the return data generated by this function. Available returnVectors include return data to the host (0xFF), return data to a variable (0x01 through 0x78), and don't return data (0).



Note The suffix `_rtn` on the function indicates that the data should be returned to the host. When this calling convention is used, no **returnVector** is required.

capturedPosition is the position value captured when the corresponding high-speed capture input went active.

Using This Function

The *Read Captured Position* function returns the value in the high-speed capture register of the axis or encoder selected. This value was captured when an enabled high-speed capture input went active.

High-speed capture functionality is performed by the encoder resources themselves. When this function is sent to an axis, the value returned is actually from the mapped encoder resource. High-speed inputs are only available on the FPGA encoder resources (0x21 through 0x24).

Refer to the *Enable High-Speed Position Capture* and *Read High-Speed Capture Status* functions for more information on the high-speed capture inputs and typical applications.

flex_read_hs_cap_status and flex_read_hs_cap_status_rtn

Read High-Speed Capture Status

Format

status = flex_read_hs_cap_status (boardID, axisOrEncoder, returnVector)

status = flex_read_hs_cap_status_rtn (boardID, axisOrEncoder, highSpeedCaptureStatus)

Purpose

Reads the high-speed position capture status for all axes or encoders.

Parameters

Input

Name	Type	Description
boardID	u8	assigned by Measurement & Automation Explorer
axisOrEncoder	u8	axis or encoder selector
returnVector	u8	destination for the return data

Output

Name	Type	Description
highSpeedCaptureStatus	u16	bitmap of high-speed capture status

Parameter Discussion

axisOrEncoder is the axis or encoder selector. For multi-axis status, use 0 (zero). For multi-encoder status, use 0x20.

returnVector indicates the desired destination for the return data generated by this function. Available returnVectors include return data to the host (0xFF), return data to a variable (0x01 through 0x78), and don't return data (0).



Note The suffix **_rtn** on the function indicates that the data should be returned to the host. When this calling convention is used, no **returnVector** is required.

highSpeedCaptureStatus is the bitmap of capture status for all axes or all encoders.

When reading high-speed capture status for axes (**axisOrEncoder** = 0):

D15	D14	D13	D12	D11	D10	D9	D8	D7	D6	D5	D4	D3	D2	D1	D0
XXX	XXX	XXX	XXX	XXX	XXX	XXX	XXX	XXX	Axis 6	Axis 5	Axis 4	Axis 3	Axis 2	Axis 1	XXX

For D1 through D6:

1 = Capture occurred

0 = Capture pending or never enabled

When reading high-speed capture status for encoders (**axisOrEncoder** = 0x20):

D15	D14	D13	D12	D11	D10	D9	D8	D7	D6	D5	D4	D3	D2	D1	D0
XXX	XXX	XXX	XXX	XXX	XXX	XXX	XXX	XXX	XXX	XXX	Enc 4	Enc 3	Enc 2	Enc 1	XXX

For D1 through D4:

1 = Capture occurred

0 = Capture pending or never enabled



Note High-speed capture inputs are only available on encoders 1 through 4 (resources 0x21 through 0x24).

Using This Function

The *Read High-Speed Capture Status* function allows you to see if a position capture has occurred or is pending. When you enable a high-speed capture input, the corresponding status bit is reset to indicate that the capture is pending. When the position capture occurs, its status bit is set to True (1). For information about retrieving the captured position value, see the *Read Captured Position* function.

The high-speed capture circuitry is also used during Find Index execution. When an index is found successfully, the capture status for the corresponding encoder and axis is set to True as a side effect.

Executing the *Find Index* function automatically leaves the corresponding high-speed capture input disabled after the index is found.

Example

Executing the *Read High-Speed Capture Status* function with **axisOrEncoder** = 0 returns **highSpeedCaptureStatus** = 0x0024, which corresponds to the following bitmap.

D15	D14	D13	D12	D11	D10	D9	D8	D7	D6	D5	D4	D3	D2	D1	D0
XXX	XXX	XXX	XXX	XXX	XXX	XXX	XXX	XXX	Axis 6	Axis 5	Axis 4	Axis 3	Axis 2	Axis 1	XXX
0	0	0	0	0	0	0	0	0	0	1	0	0	1	0	0

On encoders mapped to axes 2 and 5, high-speed captures have occurred, but all other captures are pending or were never enabled.

flex_set_hs_cap_pol

Set High-Speed Capture Polarity

Format

status = flex_set_hs_cap_pol (boardID, axisOrEncoder, highSpeedCapturePolarity)

Purpose

Sets the polarity of the high-speed capture inputs as either inverting (active-low) or noninverting (active-high).

Parameters

Input

Name	Type	Description
boardID	u8	assigned by Measurement & Automation Explorer
axisOrEncoder	u8	axis or encoder selector
highSpeedCapturePolarity	u16	bitmap of active polarities for the high-speed capture inputs

Parameter Discussion

axisOrEncoder is the axis or encoder selector. To set the high-speed capture input polarity on multiple axes, use 0 (zero). To set the high-speed capture input polarity on multiple encoder resources, use 0x20.

highSpeedCapturePolarity is the bitmap of active polarities for the high-speed capture inputs.

When setting polarities on multiple axes (**axisOrEncoder** = 0):

D15	D14	D13	D12	D11	D10	D9	D8	D7	D6	D5	D4	D3	D2	D1	D0
0	0	0	0	0	0	0	0	0	Axis 6	Axis 5	Axis 4	Axis 3	Axis 2	Axis 1	0

For D1 through D6:

1 = Inverting (default)

0 = Noninverting

When setting polarities directly on multiple encoder resources (**axisOrEncoder = 0x20**):

D15	D14	D13	D12	D11	D10	D9	D8	D7	D6	D5	D4	D3	D2	D1	D0
0	0	0	0	0	0	0	0	0	0	0	Enc 4	Enc 3	Enc 2	Enc 1	0

For D1 through D6:

1 = Inverting (default)

0 = Noninverting



Note High-speed capture inputs are only available on encoders 1 through 4 (resources 0x21 through 0x24).

Using This Function

The *Set High-Speed Capture Polarity* function defines the active polarity for each high-speed capture input as either inverting or noninverting. Inverting polarity means that an active-low input corresponds to a logical True or On state. Conversely, noninverting polarity means that an active-high input corresponds to a logical True or On state.

High-speed capture inputs are an integral part of the encoder resources. You can execute this function indirectly on axes or directly on encoder resources. When sent to multiple axes, this function sets the polarity of the high-speed capture inputs of the encoders mapped to the corresponding axes.

You can enable high-speed capture inputs to capture instantaneous encoder position when the input becomes active with the *Enable High-Speed Position Capture* function. You can also use a high-speed input as a general-purpose input and read its status with the *Read High-Speed Capture Status* function.

Find Home & Index Functions

This chapter contains detailed descriptions of the functions used to initialize your motion system and establish a repeatable reference position. The functions are arranged alphabetically by function name.

Typical closed-loop motion systems use incremental feedback to keep track of position. At power-up, this position is meaningless until a zero reference position is established. Open-loop stepper systems must also be initialized at power-up.

FlexMotion provides two built-in programs, *Find Home* and *Find Index*, to accomplish these tasks. These functions perform search sequences to find and stop on a specific edge of the home input and then find the next instance of the encoder index. In this way a repeatable reference position that is accurate to one encoder count is established.

As a quick reference, a summary of the entire FlexMotion function API is in Appendix B, *FlexMotion Functions*.

flex_find_home

Find Home

Format

status = flex_find_home (**boardID**, **axis**, **directionMap**)

Purpose

Executes a search sequence to find a home switch, approaching and stopping on a specific edge.

Parameters

Input

Name	Type	Description
boardID	u8	assigned by Measurement & Automation Explorer
axis	u8	axis to be controlled
directionMap	u16	bitmap setting the search direction, home edge and final find direction

Parameter Discussion

axis is the axis to be controlled.

directionMap is the bit map of search direction, home edge and final find direction.

D15	D14	D13	D12	D11	D10	D9	D8	D7	D6	D5	D4	D3	D2	D1	D0
0	0	0	0	0	0	0	0	0	0	0	0	0	Edge	Srch	Final

For D0 Final approach direction (Final):

1 = Reverse approach

0 = Forward approach

For D1 Initial search direction (Srch):

1 = Search reverse

0 = Search forward

For D2 Home edge to stop on (Edge):

1 = Reverse edge

0 = Forward edge

Using This Function

The *Find Home* function configures and initiates a search sequence for a home switch or other sensor. You can specify the initial search direction, the edge (rising or falling) of the home signal to stop on, and the direction you want to be travelling when you approach the specified home edge.

When the search direction is forward, the axis starts moving in the forward direction using the previously loaded values for acceleration, velocity, and s-curve. If the desired home signal transition is detected, the find home sequence continues based on the other control bits. If the forward limit switch is encountered before the home switch, the axis automatically reverses direction and continues searching for the home switch. If the reverse limit is encountered before the home switch, the sequence stops and the Home Found status is False. If a home switch exists, finding it is guaranteed. A similar search sequence is followed when the initial search direction is reverse.



Warning Forward is defined as the direction of increasing position. The Forward and Reverse Limits must be located at the proper ends of travel for the *Find Home* sequence to function properly.

You can configure the find home sequence to detect either the rising or falling edge of the home signal, as shown in Figure 9-1. You can also set the polarity of the limit and home inputs with the *Set Limit Input Polarity* and *Set Home Input Polarity* functions, respectively. Once the home switch is found, motion proceeds to approach the home edge from the desired direction. If necessary, the axis travels past the home edge and reverses direction to approach it from the programmed direction. This portion of the sequence is executed at a fixed low speed (approximately 1/4 RPS) to smoothly approach the edge. This approach direction feature is used to minimize the effects of motion system windup, backlash, and/or home sensor hysteresis.

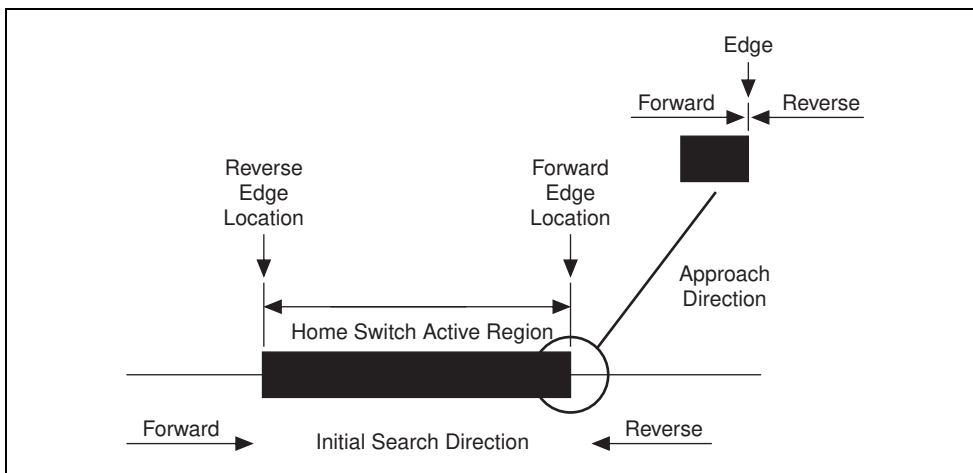

Figure 9-1. Find Home Definitions

When the home switch is found, the Home Found status is set to True. If the home sequence fails to locate the desired edge of the home signal, the Home Found status is False. You can monitor this status with the *Read per Axis Status* function.

You can execute the *Find Home* function on systems without a home switch. In this case, the sequence always terminates at the limit switch opposite to the initial search direction. The Home Found status is false and the edge and approach direction features are not applicable.



Caution You must enable both Limits and Home inputs prior to executing the *Find Home* function. If any of the axes limit or home inputs are disabled, the *Find Home* function does not start and a modal error is generated.



Note After a *Find Home* sequence is complete, the home input should be disabled because it is no longer required, assuming you do not want to stop on it the next time the system moves past it.

An unexpected limit condition during the find home sequence stops the sequence and generates a modal error. For information about errors and error handling, refer to Chapter 4, *Software Overview*. You must set unused limit and home inputs to their inactive state with the *Set Limit Input Polarity* and *Set Home Input Polarity* functions.

In open-loop systems, once the find home sequence is complete, you should reset the axis position to any desired value with the *Reset Position* function. This procedure establishes a repeatable reference position that is as accurate as the home edge location.



Note The *Find Home* function does not automatically zero position. If this action is desired, you can call the *Reset Position* function after the *Find Home* is completed.

In closed-loop encoder based systems, you can use the *Find Index* function to eliminate errors in the home edge location. In these systems, it is typically not necessary to define a specific home edge and approach direction; finding the home switch is enough. Refer to the *Find Index* function for more information.

Example

You want to find the reverse edge of the home switch on axis 2 and approach it in the forward direction. To start the search in the forward direction, call the *Find Home* function with the following parameters:

axis = 2

directionMap = 0x0004

The **directionMap** value of 0x0004 corresponds to the following bitmap.

D15	D14	D13	D12	D11	D10	D9	D8	D7	D6	D5	D4	D3	D2	D1	D0
0	0	0	0	0	0	0	0	0	0	0	0	0	Edge	Srch	Final
0	0	0	0	0	0	0	0	0	0	0	0	0	1	0	0

D0 Final approach direction = Forward (0), D1 Initial search direction = Forward (0), and D2 Home edge to stop on = Reverse (1).

As shown in Figure 9-2, this Find Home sequence searches for the home switch in the forward direction (1). When the home switch is found, the reverse edge (2) is located. When the reverse edge is located, this edge is approached in the forward direction (3).

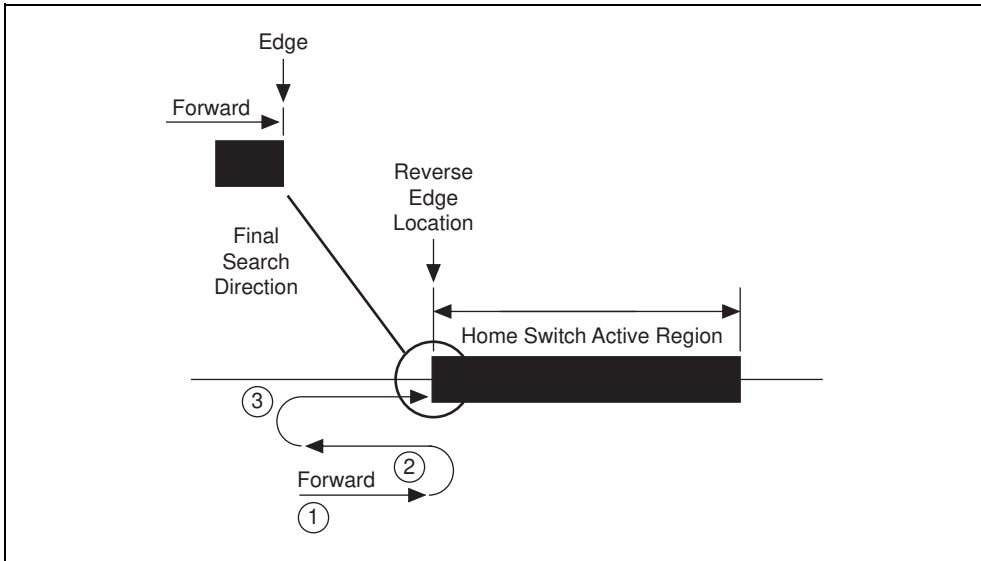

Figure 9-2. Find Home Sequence Example

flex_find_index

Find Index

Format

status = flex_find_index (boardID, axis, direction, offset)

Purpose

Executes a search sequence to find and stop on the encoder index mark, plus or minus an optional programmable offset.

Parameters

Input

Name	Type	Description
boardID	u8	assigned by Measurement & Automation Explorer
axis	u8	axis to be controlled
direction	u16	search direction
offset	i16	offset position relative to the found index position

Parameter Discussion

axis is the axis to be controlled.

direction is the search direction for the find index sequence: 0 = Search forward, 1 = Search reverse.

offset is the target position relative to the found index position. The range is $-32,768$ to $+32,767$ counts with a default value of zero (0).

Using This Function

The *Find Index* function initiates a search sequence to find the index (marker) signal of the feedback encoder. Once found, it then adds (or subtracts) the programmed offset value to the captured index position and moves to the resulting target position.

The encoder index signal is accurate to one quadrature count and provides a much more repeatable reference than using just a home switch edge. The *Find Index* function is typically called after the find home sequence is complete and before the position is reset with the *Reset Position* function. With this procedure, the home switch need only be accurate enough to

repeatably locate the axis within the same encoder revolution or index period. Then you can use the *Find Index* function to find a unique instance of the index.



Note The *Find Index* function is only available on axes with incremental encoder feedback.

The search sequence is performed in the specified direction at a fixed low velocity of 1/4 RPS unless an even lower velocity is loaded with either the *Load Velocity* or *Load Velocity in RPM* functions. To guarantee finding the index (if one exists), the length of the move is automatically set to slightly greater than one encoder revolution.



Caution You must have previously load the correct counts per revolution value with the *Load Counts/Steps per Revolution* function for the *Find Index* function to operate properly.

Upon finding the index, the motor either stops at the index position or starts a new trajectory to the index position \pm the loaded offset. This index offset move is always performed at the previous loaded values of acceleration, deceleration, s-curve, and velocity.

A successful index search is indicated with the Index Found status. You can monitor this status with the *Read per Axis Status* function. If the index is not found during the search revolution, the axis comes to a stop and indicates the failure by resetting the Index Found status. Missing the index is possible for a number of reasons including an incorrectly connected encoder or an incorrect value for counts per revolution. Refer to Chapter 5, *Signal Connections*, of your motion controller user manual for more information about encoder connections and index phasing.

You can only execute the *Find Index* function on properly configured axes that are presently stopped or killed. Attempting to execute the *Find Index* function while the axis is in motion generates a modal error. For information about errors and error handling, refer to Chapter 4, *Software Overview*, of this manual.



Note The *Find Index* function does not automatically zero the position. If this action is desired, you can call the *Reset Position* function after the *Find Index* is completed.

Analog & Digital I/O Functions

This chapter contains detailed descriptions of functions used to control the general-purpose analog and digital I/O resources on the FlexMotion controller. These resources include up to 32 bits of general-purpose digital I/O, PWM outputs, RTSI lines, and any extra encoders, ADC channels, and DAC outputs that are not mapped to an axis. The functions are arranged alphabetically by function name.

The 32 bits of digital I/O are available on the Digital I/O Connector on 7344 motion controllers. On the PC- and PCI-FlexMotion controllers, the 24 bits of digital I/O are available on the auxiliary 24-bit digital I/O connector. These bits are organized into 8-bit ports that you can configure as inputs or outputs on a port-wise basis or on a bitwise basis on the 7344 controllers. Each bit has individually programmable polarity that you can configure as inverting (active-low) or noninverting (active-high). You can use the general-purpose digital I/O for system integration applications including operator panel switch inputs and outputs, relay and solenoid activation, trigger I/O between other controllers and/or instruments in the system, and so on.

You can use encoders, ADC channels, and DAC outputs that are not mapped to an axis for general-purpose I/O. Typical uses for encoder inputs include velocity monitoring, masters for master-slave gearing, and digital potentiometer applications.

You can use unused ADC inputs and DAC outputs can be used for any analog I/O that is within their specifications. Typical analog input applications include analog joysticks, potentiometers, force, pressure, level and strain sensors, and so on. Analog output applications vary from heater element control to laser intensity modulation.

As a quick reference, a summary of the entire FlexMotion function API is in Appendix B, [FlexMotion Functions](#).

flex_configure_encoder_filter

Configure Encoder Filter

Format

`status = flex_configure_encoder_filter (boardID, axisOrEncoder, frequency)`

Purpose

Selects the maximum count frequency for an encoder channel by configuring its digital filter. This function is only supported by 7344 motion controllers.

Parameters

Input

Name	Type	Description
boardID	u8	assigned by Measurement & Automation Explorer
axisOrEncoder	u8	axis or encoder to configure
frequency	u16	maximum count frequency selector

Parameter Discussion

axisOrEncoder is the axis or encoder to be configured. Legal values are 1 through 4 (axes) or 0x21 through 0x24 (encoders).

For configuring encoders mapped to axes, you can call this function on the axis or directly on its mapped encoder.

frequency selects the maximum count frequency for the specified encoder.

frequency Value	Maximum Count Frequency
0	25.6 MHz
1	12.8 MHz
2	6.4 MHz
3	3.2 MHz
4	1.6 MHz (default)
5	800 kHz
6	400 kHz
7	200 kHz
8	100 kHz
9	50 kHz
10	25 kHz

Using This Function

Setting the maximum allowable count frequency for an encoder is useful for reducing the effect of noise on the encoder lines. Noise on the encoder lines can be interpreted as extra encoder counts. By setting the frequency to the lowest possible setting required for your motion application, you can ensure the highest degree of accuracy in positioning. In choosing the appropriate value, you should take into account the counts per revolution of your encoder and the maximum velocity for the axis in question.

For example, with a 20,000 counts per revolution encoder and a maximum velocity of 3,000 RPM (50 revolutions per second), the encoder signal could be as high as 1,000,000 counts per second. A frequency value of 4, which would correspond to a maximum count frequency of 1.6 MHz would be appropriate in this case.

If you never call this function, a default value of 4 (1.6 MHz) is used by the 7344 controller.

flex_configure_pwm_output

Configure PWM Output

Format

`status = flex_configure_pwm_output (boardID, u8 PWMOutput, u16 enable, u16 clock)`

Purpose

Enables and disables PWM outputs, and sets the PWM clock frequency.

Parameters

Input

Name	Type	Description
boardID	u8	assigned by Measurement & Automation Explorer
PWMOutput	u8	PWM Output
enable	u16	enable/disable for PWM Output
clock	u16	clock selector

Parameter Discussion

PWMOutput selects the PWM Output to configure (1 or 2).

enable enables or disables the specified PWM Output. When enabled, the **clock** parameter determines the clock frequency used for the PWM output.

1 = enabled

0 = disabled

clock specifies the clock frequency for the PWM output.

The base clock frequency for the PWM outputs is 8.2575 MHz on the PC- and PCI-FlexMotion controllers, and 10.240 MHz on the 7344 controllers. This base clock frequency is divided down depending on the clock value selected. Table 10-1 lists the PWM clock frequency settings.

Table 10-1. PWM Clock Frequency Settings

Clock Value	Divide Down Factor	FlexMotion-6C Controllers	7344 Controllers
0	$2^8 = 256$	32.256 kHz	40 kHz
1	$2^9 = 512$	16.128 kHz	20 kHz
2	$2^{10} = 1,024$	8.064 kHz	10 kHz
3	$2^{11} = 2,048$	4.032 kHz	5 kHz
4	$2^{12} = 4,096$	2.016 kHz	2.5 kHz
5	$2^{13} = 8,192$	1.008 kHz	1.25 kHz
6	$2^{14} = 16,384$	504 Hz	625 Hz
7	$2^8 = 256$	External Clock/256	External Clock/32768
8	$2^{15} = 32,768$	252 Hz	312.50 Hz
9	$2^{16} = 65,536$	126 Hz	156.25 Hz
10	$2^{17} = 131,072$	63 Hz	78.13 Hz
11	$2^{18} = 262,144$	31.5 Hz	39.06 Hz
12	$2^{19} = 524,288$	15.75 Hz	19.53 Hz
13	$2^{20} = 1,048,576$	7.87 Hz	9.77 Hz
14	$2^{20} = 2,097,152$	3.94 Hz	4.88 Hz
15	$2^{15} = 32,768$	External Clock/ 32,768	External Clock/ 32,768

Using This Function

The PWM outputs on your FlexMotion controller are digital pulse-train outputs that have a frequency specified by the **clock** parameter of this function and a duty cycle specified by the [Load PWM Duty Cycle](#) function. These outputs can be used to control devices that require a PWM input, such as a laser whose intensity is controlled by a PWM signal, or can be used to generate isolated analog outputs by passing the PWM output through an optocoupler, and then filtering the digital pulse train to produce an analog output voltage.

When you configure a PWM output, the clock frequency applies to both PWM outputs. If you configure one PWM output for a clock value of 3, and then the second PWM output for a clock value of 4, the value of 4 will apply to both PWM outputs. The only exception is when

the clock settings for the two PWM outputs are 0 and 8, 1 and 9, 2 and 10, and so on, in which case each output will have a different frequency.

On the PC- and PCI-FlexMotion controllers, the PWM outputs PWM1 and PWM2 share bits 0 (pin 15) and 1 (pin 13) of port 3 on the 24-bit Digital I/O connector. When configured as PWM outputs, the PWM1 and/or PWM2 outputs cannot be used as general-purpose outputs, but the other bits in the port can be used simultaneously without affecting the PWM outputs.

On the 7344 controllers, the PWM outputs have dedicated pins on the Digital I/O connector.

To use an external clock (clock values of 7 or 15), connect your external clock signal to the PCLK input on the Digital I/O connector.

flex_enable_adcs

Enable ADCs

Format

status = flex_enable_adcs (boardID, reserved, ADCMap)

Purpose

Enables one or more of the unmapped ADC channels.

Parameters

Input

Name	Type	Description
boardID	u8	assigned by Measurement & Automation Explorer
reserved	u8	unused input
ADCMap	u16	bitmap of ADCs to enable

Parameter Discussion

reserved is an unused input. The input value is ignored.

ADCMap is the bitmap of ADC channels to enable.

D15	D14	D13	D12	D11	D10	D9	D8	D7	D6	D5	D4	D3	D2	D1	D0
0	0	0	0	0	0	0	0	ADC 8	ADC 7	ADC 6	ADC 5	ADC 4	ADC 3	ADC 2	ADC 1

D0 through D7:

1 = ADC channel enabled (default)

0 = ADC channel disabled

Using This Function

The *Enable ADCs* function enables one or more independent ADC channels for use as general-purpose analog inputs. This function has no effect on channels that are mapped to axes and being used for axis feedback. These feedback channels are automatically enabled/disabled when you enable or disable their corresponding axis with the *Enable Axes* function. Bit locations corresponding to mapped ADC channels are ignored.

The FlexMotion Analog-to-Digital Converter (ADC) multiplexes between channels with a scan rate of approximately 50 μs per channel (40 μs for the 7344 controller). Therefore, the time between samples for a specific ADC channel is as follows:

$$\text{ADC sample time} = 50 \mu\text{s}/\text{channel} \times (\text{number of enabled channels})$$

By default, all channels are enabled at power up. You should disable unused channels to increase the scan rate and decrease the sample time.



Note The 50 μs /channel scan rate is fast enough to support analog feedback at the fastest PID update rates as long as no additional ADC channels are enabled.

Example

To enable ADC channels 1, 3, 5, and 7 on the FlexMotion controller, call the *Enable ADCs* function with **ADCMap** = 0x0055, which corresponds to the following bitmap.

D15	D14	D13	D12	D11	D10	D9	D8	D7	D6	D5	D4	D3	D2	D1	D0
0	0	0	0	0	0	0	0	ADC 8	ADC 7	ADC 6	ADC 5	ADC 4	ADC 3	ADC 2	ADC 1
0	0	0	0	0	0	0	0	0	1	0	1	0	1	0	1

Under normal conditions, because ADC channels 2, 4, 6, and 8 are set to zero (0) they are disabled when you execute this function. However, if ADC channel 2 is already being used as feedback for axis 2, the disable (0) for ADC 2 is ignored resulting in the following bitmap of enabled ADCs.

D15	D14	D13	D12	D11	D10	D9	D8	D7	D6	D5	D4	D3	D2	D1	D0
0	0	0	0	0	0	0	0	ADC 8	ADC 7	ADC 6	ADC 5	ADC 4	ADC 3	ADC 2	ADC 1
0	0	0	0	0	0	0	0	0	1	0	1	0	1	1	1

In this example there are five ADCs enabled, so the sample time for each ADC channel is as follows:

$$\text{ADC sample time} = 50 \mu\text{s}/\text{channel} \times 5 = 250 \mu\text{s}$$

This puts a limit on the fastest PID update rate practically achievable. You can set a faster PID update rate with the *Enable Axes* function, but the PID loop will not truly operate at that faster rate because the ADC channels used as feedback are not being sampled fast enough.

flex_enable_encoders

Enable Encoders

Format

status = flex_enable_encoders (boardID, encoderMap)

Purpose

Enables one or more of the unmapped encoder resources.

Parameters

Input

Name	Type	Description
boardID	u8	assigned by Measurement & Automation Explorer
encoderMap	u16	bitmap of encoders to enable

Parameter Discussion

encoderMap is the bitmap of encoder resources to enable.

D15	D14	D13	D12	D11	D10	D9	D8	D7	D6	D5	D4	D3	D2	D1	D0
0	0	0	0	0	0	0	0	0	Enc 6	Enc 5	Enc 4	Enc 3	Enc 2	Enc 1	0

D1 through D6:

1 = Encoder enabled

0 = Encoder disabled (default)

Using This Function

The *Enable Encoders* function enables one or more independent encoder channels for use as general-purpose encoder inputs. It has no effect on encoders that are mapped to axes and being used for axis feedback. These feedback encoders are automatically enabled/disabled when their corresponding axis is enabled or disabled with the *Enable Axes* function. Bit locations corresponding to mapped encoders are ignored.

Typical uses for independent encoder inputs include velocity monitoring, masters for master-slave gearing, and digital potentiometer applications.

Example

To enable encoders 3 and 4 on the FlexMotion controller, call the *Enable Encoders* function with **encoderMap** = 0x0018, which corresponds to the following bitmap.

D15	D14	D13	D12	D11	D10	D9	D8	D7	D6	D5	D4	D3	D2	D1	D0
0	0	0	0	0	0	0	0	0	Enc 6	Enc 5	Enc 4	Enc 3	Enc 2	Enc 1	0
0	0	0	0	0	0	0	0	0	0	0	1	1	0	0	0

Normally, because encoders 1, 2, 5, and 6 are set to zero (0), they will be disabled by this function execution. However, if encoder 2 is already being used as feedback for axis 2, the disable (0) for Enc 2 is ignored resulting in the following bitmap of enabled encoders.

D15	D14	D13	D12	D11	D10	D9	D8	D7	D6	D5	D4	D3	D2	D1	D0
0	0	0	0	0	0	0	0	0	Enc 6	Enc 5	Enc 4	Enc 3	Enc 2	Enc 1	0
0	0	0	0	0	0	0	0	0	0	0	1	1	1	0	0

There is a limit on the number of enabled encoders supportable at the faster update rates. Attempting to enable too many encoders generates an error. See the *Enable Axes* function for more information on update rate limitations.

flex_load_dac

Load DAC

Format

status = flex_load_dac (boardID, DAC, outputValue, inputVector)

Purpose

Loads an output value to an unmapped DAC resource.

Parameters

Input

Name	Type	Description
boardID	u8	assigned by Measurement & Automation Explorer
DAC	u8	DAC to be controlled
outputValue	i16	value sent to the DAC
inputVector	u8	source of the data for this function

Parameter Discussion

DAC is the DAC to be controlled.

outputValue is the value sent to the DAC. The parameter range is $-32,768$ to $+32,767$, corresponding to the full ± 10 V output range.



Note DAC torque limits and offsets do not apply when directly loading a DAC.

inputVector indicates the source of the data for this function. Available **inputVectors** include immediate (0xFF) or variable (0x01 through 0x78).

Using This Function

The *Load DAC* function is used to send a value directly to an unmapped DAC resource. DACs not mapped as servo axis outputs are available for general-purpose analog out applications.



Caution You should not execute this function on a DAC mapped to an axis. Doing so will cause the DAC output to glitch momentarily before returning to axis control.

flex_load_pwm_duty

Load PWM Duty Cycle

Format

status = flex_load_pwm_duty (boardID, PWMOutput, dutyCycle, inputVector)

Purpose

Sets the duty cycle for a PWM output.

Parameters

Input

Name	Type	Description
boardID	u8	assigned by Measurement & Automation Explorer
PWMOutput	u8	PWM Output
dutyCycle	u16	duty cycle for PWM Output
inputVector	u8	source of the data for this function

Parameter Discussion

PWMOutput selects the PWM Output to control (1 or 2).

dutyCycle is a value between 0 and 255 that specifies the amount of time the PWM output is high.

inputVector indicates the source of the data for this function. Available inputVectors include immediate (0xFF) and variable (0x01 through 0x78).

Using This Function

The **dutyCycle** determines the amount of time the PWM output is high. A **dutyCycle** of 0 corresponds to a 0 V output, and a **dutyCycle** of 255 corresponds to a pulse train that is high for $255/256 = 99.6\%$ of the time. Use the [Configure PWM Output](#) function to set the frequency of the PWM output signal.

You can set the duty cycle before or after configuring a PWM output. By default, the **dutyCycle** is 0, so if you call the [Configure PWM Output](#) function to configure a PWM output, the output will be low until you set the **dutyCycle** differently. If you set the **dutyCycle** first, the PWM output will reflect this **dutyCycle** immediately after calling the [Configure PWM Output](#) function.

flex_read_adc and flex_read_adc_rtn

Read ADC

Format

status = flex_read_adc (boardID, ADC, returnVector)

status = flex_read_adc_rtn (boardID, ADC, ADCValue)

Purpose

Reads the converted value from an ADC input channel.

Parameters

Input

Name	Type	Description
boardID	u8	assigned by Measurement & Automation Explorer
ADC	u8	ADC channel to be read
returnVector	u8	destination for the return data

Output

Name	Type	Description
ADCValue	i16	the converted analog value

Parameter Discussion

ADC is the Analog-to-Digital Converter channel to be read. Valid ADC resources are 0x51 through 0x58.

returnVector indicates the desired destination for the return data generated by this function. Available returnVectors include return data to the host (0xFF), return data to a variable (0x01 through 0x78), and don't return data (0).



Note The suffix `_rtn` on the function indicates that the data should be returned to the host. When this calling convention is used, no **returnVector** is required.

ADCValue is the signed 12-bit value from the ADC channel. **ADCValue** is from -2,048 to +2,047 for the ± 5 V and ± 10 V ranges, and 0 to 4,096 for the 0 to 5 V and 0 to 10 V ranges.

The voltage range is set through the *Set ADC Range* function for 7344 controllers and is always ± 10 V for FlexMotion-6C controllers.

Using This Function

The *Read ADC* function returns the converted voltage from any of the analog input channels. You can only read values from channels that have been either directly enabled by the *Enable ADCs* function or automatically enabled by being mapped to an enabled axis.

For an ADC channel mapped to an axis, this function returns the actual ADC value. In contrast, the *Read Position* function executed on the owner axis returns an ADC value that has been offset by a reset value stored when the *Reset Position* function was executed. ADC channels are never internally reset so their DC values are preserved.

On the FlexMotion-6C controllers, all 8 ADC inputs are on the 100-pin Motion I/O connector. On the 7344 controllers, ADC inputs 1 through 4 are on the 68-pin Motion I/O connector, and the remaining four inputs are wired as follows.

ADC Input	Description
5	Cleaned +5 V PC supply
6	Not connected
7	Analog reference
8	Analog ground

flex_read_encoder and flex_read_encoder_rtn

Read Encoder Position

Format

status = flex_read_encoder (boardID, axisOrEncoder, returnVector)

status = flex_read_encoder_rtn (boardID, axisOrEncoder, encoderCounts)

Purpose

Reads the position of an encoder.

Parameters

Input

Name	Type	Description
boardID	u8	assigned by Measurement & Automation Explorer
axisOrEncoder	u8	axis or encoder to be read
returnVector	u8	destination for the return data

Output

Name	Type	Description
encoderCounts	i32	encoder position in quadrature counts

Parameter Discussion

axisOrEncoder is the axis or encoder to be read.

returnVector indicates the desired destination for the return data generated by this function. Available returnVectors include return data to the host (0xFF), return data to a variable (0x01 through 0x78), and don't return data (0).



Note The suffix `_rtn` on the function indicates that the data should be returned to the host. When this calling convention is used, no **returnVector** is required.

encoderCounts is the encoder position in quadrature counts.

Using This Function

The *Read Encoder Position* function returns the quadrature count value of the encoder selected. The encoder must be enabled, either directly through the *Enable Encoders* function or automatically, by being mapped to an enabled axis.

The *Read Encoder Position* function is typically used to read the value of an encoder that is not part of an axis. This encoder could be a master encoder used for master-slave gearing or an independent position or velocity sensor.

For reading encoders mapped to axes, you can call this function on the axis or directly on its mapped encoder. For servo axes, both approaches return the same value as the *Read Position* function. On stepper axes however, this function can return additional useful information.

During axis setup, you can operate the closed-loop stepper axis in open-loop mode and use this function to directly measure the counts per revolution and steps per revolution for the axis. These values must be loaded before for subsequent closed-loop operation. Refer to the *Load Counts/Steps per Revolution* function for more information.

You can also use this function to return a finer reading of position in cases where the encoder resolution greatly exceeds the step resolution of the closed-loop stepper axis.

flex_read_port and flex_read_port_rtn

Read I/O Port

Format

status = flex_read_port (boardID, port, returnVector)

status = flex_read_port_rtn (boardID, port, portData)

Purpose

Reads the logical state of the bits in an I/O port.

Parameters

Input

Name	Type	Description
boardID	u8	assigned by Measurement & Automation Explorer
port	u8	general-purpose I/O port to be read
returnVector	u8	destination for the return data

Output

Name	Type	Description
portData	u16	bitmap of the logical state of the I/O port

Parameter Discussion

port is the general-purpose I/O port (1, 2, 3, or 4) or RTSI software port (5) to be read.

returnVector indicates the desired destination for the return data generated by this function. Available returnVectors include return data to the host (0xFF), return data to a variable (0x01 through 0x78), and don't return data (0).



Note The suffix `_rtn` on the function indicates that the data should be returned to the host. When this calling convention is used, no **returnVector** is required.

portData is the bitmap of the logical state of the I/O port.

D15	D14	D13	D12	D11	D10	D9	D8	D7	D6	D5	D4	D3	D2	D1	D0
XXX	XXX	XXX	XXX	XXX	XXX	XXX	XXX	Bit 7	Bit 6	Bit 5	Bit 4	Bit 3	Bit 2	Bit 1	Bit 0

For D0 through D7:

1 = I/O bit True (On)

0 = I/O bit False (Off)

Using This Function

The [Read I/O Port](#) function reads the logical state of the bits in the general-purpose I/O port selected. You can execute this function at anytime to monitor the signals connected to an input port. Reads of ports configured as outputs return the last value written to the port with the [Set I/O Port MOMO](#) function.



Note This function reads the logical state (On or Off, True or False) of the bits in a port. The polarity of the bits in the port determines whether an On state is active-high or active-low. Refer to the [Set I/O Port Polarity](#) function for more information.

PC- and PCI-FlexMotion controllers have three ports: 1, 2, and 3.

When reading the RTSI port on 7344 controllers, the value read is the latched data, so you can detect active pulses on the RTSI bus. After reading the latched data value, the function resets the latch. Use the [Set I/O Port Polarity](#) function to specify the polarity, and therefore the active state for latching.

flex_reset_encoder

Reset Encoder Position

Format

status = flex_reset_encoder (boardID, encoder, position, inputVector)

Purpose

Resets the position of an unmapped encoder to the specified value.

Parameters

Input

Name	Type	Description
boardID	u8	assigned by Measurement & Automation Explorer
encoder	u8	encoder to be reset
position	i32	reset value for encoder
inputVector	u8	source of the data for this function

Parameter Discussion

encoder is encoder to be reset.

position is the reset value for the encoder resource. You can reset position to any value in the total position range of $-(2^{31})$ to $+(2^{31}-1)$.

inputVector indicates the source of the data for this function. Available inputVectors include immediate (0xFF) or variable (0x01 through 0x78).

Using This Function

The *Reset Encoder Position* function resets the position of the selected encoder. You can reset position to zero or to any value in the 32-bit position range. You can only execute this function on independent encoders that are not mapped to axes. For encoders mapped to axes, you should use the *Reset Position* function instead.



Note Attempting to reset an encoder that is mapped to an axis generates an error.

Encoder position can be reset at any time. However, it is recommended that you reset position only while the encoder is stopped. A encoder reset while it is moving will not have a repeatable reference position.



Note Non-zero reset values are useful for defining a position reference offset.

flex_select_signal

Select Signal

Format

status = flex_select_signal (boardID, destination, source)

Purpose

Specifies the source and destination for various motion signals, including trigger inputs, high-speed capture circuits, breakpoint outputs, RTSI lines, and RTSI software ports. This function is only supported by 7344 motion controllers.

Parameters

Input

Name	Type	Description
boardID	u8	assigned by Measurement & Automation Explorer
destination	u16	destination of signal
source	u16	source of signal

Parameter Discussion

destination is the destination of the signal coming from **source**.

source is the source of the signal to be routed to **destination**.

For a **destination** value of NIMC_HS_CAPTURE[1..4] (Value 8–11), the valid **source** values are as follows.

source	Value	Comments
NIMC_RTSM[0..6]	0–6	RTSM lines 0 through 6
NIMC_PXI_STAR_TRIGGER	7	PXI star trigger line
NIMC_TRIGGER_INPUT	8	Trigger input for the corresponding axis

For a **destination** value of NIMC_RTISI[0..6] (Value 0–6) or NIMC_PXI_STAR_TRIGGER (Value 7), the valid **source** values are as follows.

source	Value	Comments
NIMC_BREAKPOINT[1..4]	9–12	Breakpoint outputs
NIMC_RTISI_SOFTWARE_PORT	13	Corresponding bit in RTISI software port
NIMC_DONT_DRIVE	14	Sets RTISI pin back to input state

Using This Function

When the destination is NIMC_RTISI[0..6] or NIMC_PXI_STAR_TRIGGER, the motion controller drives the RTISI line as an output. When the destination is NIMC_HS_CAPTURE[1..4], the RTISI line serves as an input for the high-speed capture circuitry. The RTISI lines can always be read using the [Read I/O Port](#) function, regardless of the way they are currently configured.

Examples

Example 1

To use the signal coming in on RTISI pin 3 to trigger the high-speed capture on encoder/axis 1, call Select Signal as follows:

```
flex_select_signal (boardID, NIMC_HS_CAPTURE1, NIMC_RTISI3)
```

The polarity of the high-speed capture input is specified by the [Set High-Speed Capture Polarity](#) function.

Example 2

To output the breakpoint signal for axis 2 on RTISI pin 4, call Select Signal as follows:

```
flex_select_signal (boardID, NIMC_RTISI4, NIMC_BREAKPOINT2)
```

The signal seen on the RTISI 4 pin will be a high pulse of 120 to 150 ns duration. The action specified in the [Enable Breakpoint](#) function only applies to the breakpoint output pin on the motion I/O connector, not to RTISI pins.

Example 3

To drive RTISI pin 5 with the corresponding bit (bit 5) of the RTISI software port, call Select Signal as follows:

```
flex_select_signal (boardID, NIMC_RTISI5, NIMC_SOFTWARE_PORT)
```

To set the state of the RTISI software port, use the [Set I/O Port MOMO](#) function.

Example 4

When writing to the RTSI software port by using the *Set I/O Port MOMO* function, only those RTSI lines that have been configured to be controlled by the RTSI software port will be affected. To set the RTSI line back to an input, call Select Signal as follows:

```
flex_select_signal (boardID, NIMC_RTSI5, NIMC_DONT_DRIVE)
```

flex_set_adc_range

Set ADC Range

Format

status = flex_set_adc_range (boardID, ADC, range)

Purpose

Sets the voltage range for the analog to digital converters, on a per-channel basis.

Parameters

Input

Name	Type	Description
boardID	u8	assigned by Measurement & Automation Explorer
ADC	u8	ADC channel to configure
range	u16	the voltage range for the specified ADC

Parameter Discussion

ADC is the analog-to-digital converter channel to configure. Valid ADC resources are 0x51 through 0x58.

range specifies the input voltage range over which the ADC will convert input voltages to digital values. Voltages outside of the range will clamp at the extremes, which are -2,048 or +2,047 for the -5 to +5 V and -10 to +10 V ranges, and 0 or 4,096 for the 0 to +5 V and 0 to +10 V ranges. You can choose from the following values for the range.

range Constant	range Value	Range (Volts)	Binary Values
NIMC_ADC_UNIPOLAR_5	0	0 to +5	0 to +4,096
NIMC_ADC_BIPOLAR_5	1	-5 to +5	-2,048 to +2,047
NIMC_ADC_UNIPOLAR_10	2	0 to +10	0 to +4,096
NIMC_ADC_BIPOLAR_10	3	-10 to +10	-2,048 to +2,047

The constants listed previously are defined in the FlexMotion header files motncnst.h (for C/C++ users) and motncnst.bas (for Visual Basic users).



Note The only valid choice for FlexMotion-6C controllers is 3, which corresponds to the -10 to $+10$ V range. The 7344 controllers provide for all four ranges.

Using This Function

If you do not call this function, the range defaults to -10 to $+10$ V. If you know that your input voltage falls within a more restrictive range, you can effectively increase the resolution of your measurements by selecting an appropriate range from the previous list.

For example, if your input signal ranges from -3 to $+3$ V, and you select the -5 to $+5$ V range, the 4,096 discrete values for the ADC will be 2.44 mV apart instead of the 4.88 mV apart when using the -10 to $+10$ V range.

For more information, refer to the [Read ADC](#) and [Enable ADCs](#) functions.

flex_set_port_direction

Set I/O Port Direction

Format

status = flex_set_port_direction (boardID, port, directionMap)

Purpose

Sets the direction of a general-purpose I/O port as input or output.

Parameters

Input

Name	Type	Description
boardID	u8	assigned by Measurement & Automation Explorer
port	u8	general-purpose I/O port to be controlled
directionMap	u16	port direction control

Parameter Discussion

port is the general-purpose I/O port (1, 2, 3, or 4) to be controlled.



Note On FlexMotion-6C controllers, which have three ports (1, 2, and 3), I/O port 3 is an output-only port and cannot be set to input.

directionMap is the bitmap of directions for the bits in the I/O port.

D15	D14	D13	D12	D11	D10	D9	D8	D7	D6	D5	D4	D3	D2	D1	D0
0	0	0	0	0	0	0	0	Bit 7	Bit 6	Bit 5	Bit 4	Bit 3	Bit 2	Bit 1	Bit 0

For D0 through D7:

1 = Input (default)

0 = Output



Note On FlexMotion-6C controllers, all bits in a port must be set to the same direction, leading to a **directionMap** of 0xFF (all inputs) or 0 (all outputs).

Using This Function

The *Set I/O Port Direction* function configures the bits in a general-purpose I/O port as input or output. After setting the direction, use the *Read I/O Port* function to read the port, the *Set I/O Port MOMO* function to write to the port, and the *Set I/O Port Polarity* function to set the polarity of each bit in the port to active-high or active-low.



Notes On PC-FlexMotion and PCI-FlexMotion controllers, bits 5 and 6 of I/O port 2 have special capabilities and are input only. When I/O port 2 is set as output, you cannot use bits 5 and 6.

The direction of bits in the RTSI software port (port 5) on 7344 controllers is controlled with the *Select Signal* function.

flex_set_port_momo

Set I/O Port MOMO

Format

status = flex_set_port_momo (boardID, port, mustOn, mustOff)

Purpose

Sets an I/O port value using the MustOn/MustOff protocol.

Parameters

Input

Name	Type	Description
boardID	u8	assigned by Measurement & Automation Explorer
port	u8	general-purpose I/O port to be controlled
mustOn	u16	bitmap of I/O port bits to be forced on
mustOff	u16	bitmap of I/O port bits to be forced off

Parameter Discussion

port is the general-purpose I/O port (1, 2, 3, or 4) or RTSI software port (5) to be controlled.

mustOn is the bitmap of I/O port bits to be forced on.

D7	D6	D5	D4	D3	D2	D1	D0
mustOn 7	mustOn 6	mustOn 5	mustOn 4	mustOn 3	mustOn 2	mustOn 1	mustOn 0

For D0 through D7:

1 = I/O bit forced to logical On

0 = I/O bit left unchanged (default)

mustOff is the bitmap of I/O port bits to be forced off.

D7	D6	D5	D4	D3	D2	D1	D0
mustOff 7	mustOff 6	mustOff 5	mustOff 4	mustOff 3	mustOff 2	mustOff 1	mustOff 0

For D0 through D7:

1 = I/O bit forced to logical Off

0 = I/O bit left unchanged (default)

Using This Function

The *Set I/O Port MOMO* function sets the logical state of bits in the general-purpose I/O port selected.

Using the MustOn/MustOff protocol allows you to set or reset individual bits without affecting other output bits in the port. This gives you tri-state control over each bit: On, Off or Unchanged. A one (1) in a bit location of the MustOn bitmap turns the bit On, while a one (1) in the corresponding location of the MustOff bitmap turns the bit Off. A zero (0) in either bitmap has no effect, so leaving both the MustOn and MustOff bits at zero is effectively a hold and the state of the bit is unchanged. If you set both the MustOn and MustOff bits to one (1), it is interpreted as a MustOn condition and the bit is turned On.



Note This function sets the logical state of a bit On or Off (True or False). The polarity of the bits in the port determines whether an On state is active-high or active-low. Refer to the *Set I/O Port Polarity* function for more information.

The *Set I/O Port MOMO* function allows individual control of general-purpose output bits without requiring a shadow value or a read of the port to remember the state of other bits not being set or reset with the function.

Example

In I/O port 2, to set bits 1 and 3 On, bits 0 and 5 Off and to leave the other bits (2, 4, 6, and 7) unchanged, call this function with the following parameters:

port = 2

mustOn = 0x0A, where the value 0x0A corresponds to the following bitmap

D7	D6	D5	D4	D3	D2	D1	D0
mustOn 7	mustOn 6	mustOn 5	mustOn 4	mustOn 3	mustOn 2	mustOn 1	mustOn 0
0	0	0	0	1	0	1	0

mustOff = 0x21, where the value 0x21 corresponds to the following bitmap

D7	D6	D5	D4	D3	D2	D1	D0
mustOff 7	mustOff 6	mustOff 5	mustOff 4	mustOff 3	mustOff 2	mustOff 1	mustOff 0
0	0	1	0	0	0	0	1



Note PC- and PCI-FlexMotion controllers have three ports: 1, 2, and 3.

On 7344 controllers, you can always write to the RTSI software port, but the actual RTSI lines on the physical RTSI port are only affected if the RTSI line has been configured properly by using the *Select Signal* function. By default, none of the RTSI lines are configured to output their corresponding bits in the RTSI software port; you must configure each RTSI line individually using the *Select Signal* function, rather than the *Set I/O Port Direction* function.

flex_set_port_pol

Set I/O Port Polarity

Format

status = flex_set_port_pol (**boardID**, **port**, **portPolarityMap**)

Purpose

Sets the bit polarity in a general-purpose I/O port.

Parameters

Input

Name	Type	Description
boardID	u8	assigned by Measurement & Automation Explorer
port	u8	general-purpose I/O port to be controlled
portPolarityMap	u16	bitmap of active polarities

Parameter Discussion

port is the general-purpose I/O port (1, 2, 3, or 4) or RTSI software port (5) to be controlled.

portPolarityMap is the bitmap of active polarities for the I/O port.

D15	D14	D13	D12	D11	D10	D9	D8	D7	D6	D5	D4	D3	D2	D1	D0
0	0	0	0	0	0	0	0	Bit 7	Bit 6	Bit 5	Bit 4	Bit 3	Bit 2	Bit 1	Bit 0

For D0 through D7:

1 = Inverting (active-low) (default)

0 = Noninverting (active-high)

Using This Function

The *Set I/O Port Polarity* function sets the polarity of the general-purpose I/O port on an individual bit basis. You can set each bit for either inverting or noninverting polarity. Inverting polarity means that a logical True or On state corresponds to an active-low signal on the pin. Conversely, noninverting polarity means that a logical True (On) corresponds to an active-high signal on the pin.

Typically, ports and their pins are configured for direction and polarity at initialization. After configuration, you can then read or write logical states (True or False, On or Off) to ports without worrying about the physical states of signals on the port pins.

On 7344 controllers, the polarity also defines the latching behavior for the RTSI port. In order to detect short pulses on RTSI lines, the hardware latches active-going signals and holds that state until the port is read. For example, if you configure a bit for inverting polarity, a transition from high to low will be latched until read, even if the signal goes high again. If the signal starts low, it will also be latched until read, even if the signal is high when you read the bit.



Note PC- and PCI-FlexMotion controllers have three ports: 1, 2, and 3.

Error & Utility Functions

This chapter contains detailed descriptions of error handling functions and utility functions for getting information about your motion controller. Refer to Chapter 4, *Software Overview*, for an overview of modal versus non-modal errors and a discussion on error handling techniques. The functions are arranged alphabetically by function name.

As a quick reference, a summary of the entire FlexMotion function API is in Appendix B, *FlexMotion Functions*.

flex_get_error_description

Get Error Description

Format

status=flex_get_error_description (descriptionType, errorCode, commandID, resourceID, charArray, sizeOfArray)

Purpose

Gets an error, command, and/or resource description string as an ASCII character array.

Parameters

Input

Name	Type	Description
descriptionType	u16	type of description selector
errorCode	i32	error code
commandID	u16	command ID number
resourceID	u16	resource ID number

Input/Output

Name	Type	Description
sizeOfArray	u32	size of character array

Output

Name	Type	Description
charArray	[i8]	character array

Parameter Discussion

descriptionType is the selector for the type of description string to return.

descriptiveType Constant	descriptionType Value
NIMC_ERROR_ONLY	0
NIMC_FUNCTION_NAME_ONLY	1
NIMC_RESOURCE_NAME_ONLY	2
NIMC_COMBINED_DESCRIPTION	3

errorCode is an error code from a function return status or the error code returned from the [Read Error Message](#) function.

commandID is the command ID of a function.

resourceID is the resource ID of an axis, vector space, encoder, ADC, DAC, or other resource.

sizeOfArray is the number of characters in the description plus one for the NULL string terminator. As an input, this I/O parameter specifies the size of the allocated array. If **sizeOfArray** and/or **charArray** is NULL or zero (0), the required size of the array (not including the NULL terminator) is returned in the **sizeOfArray** parameter as an output.

charArray is an array of ASCII characters containing the error, command, and/or resource description string. This function places all or part of the selected string in **charArray**, if **sizeOfArray** is greater than zero (> 0).

Using This Function

The [Get Error Description](#) function returns the selected description string as an ASCII character array. You must allocate space for this array on the host computer before calling this function. You can use this function to generate a string for displaying a function name, a resource name, an error code description, or a complete error description string in response to an error code returned as a function status or the result of calling the [Read Error Message](#) function.

Not all input parameters are required for each description type. The following parameters are required to return an accurate description string.

descriptionType	errorCode	commandID	resourceID
NIMC_ERROR_ONLY	required	not required	not required
NIMC_FUNCTION_NAME_ONLY	not required	required	not required
NIMC_RESOURCE_NAME_ONLY	not required	required	required
NIMC_COMBINED_DESCRIPTION	required	required	required

Because resource IDs are not unique (for example, axis 1 and program 1 both are resource 1), the command ID is required to set the context and allow this function to generate the proper resource name string.

If NULL (or 0) is passed in either the **charArray** or **sizeOfArray** parameters, the required size of the array (not including the NULL terminator) is returned in the **sizeOfArray** parameter. You can use this feature when you want to allocate only the memory necessary to hold the description string. This function is then called twice: once to get the required array size, and once again to actually retrieve the description.

The number of characters required for the character array is always one more than the actual number of characters in the controller name due to the NULL terminator at the end of the string.



Note If **sizeOfArray** is smaller than the actual description string, this function returns a partial string with the last three characters replaced by . . . to indicate that the string is not complete.

Example

After executing a Find Index sequence on axis 1, a modal error is detected. A call to the [Read Error Message](#) function returns the following set of parameters:

commandID = 334

resourceID = 0x01

errorCode = 124

To generate an error description string for display, call the [Get Error Description](#) function with these parameters, plus a **descriptionType**, **sizeOfArray** = 0 and **charArray** = NULL. When the function returns, **sizeOfArray** will have the size of the description in it. Allocate memory for a character array of size **sizeOfArray** + 1. Call the [Get Error Description](#) function a second time passing in the same parameters as before except **sizeOfArray** is the value of **sizeOfArray** + 1 returned by the first function call, and **charArray** points to the

character array just allocated. This function returns the following strings, depending upon the **descriptionType** selected.

descriptionType Constant	String
NIMC_ERROR_ONLY	Error 124 (NIMC_findIndexError); Find Index sequence did not find the index successfully
NIMC_FUNCTION_NAME_ONLY	Find Index (flex_find_index)
NIMC_RESOURCE_NAME_ONLY	Axis 0x01
NIMC_COMBINED_DESCRIPTION	Error 124 (NIMC_findIndexError) occurred in Find Index (flex_find_index) on Axis 0x01; Find Index sequence did not find the index successfully

flex_get_motion_board_info

Get Motion Board Information

Format

status=flex_get_motion_board_info (boardID, informationType, informationValue)

Purpose

Gets information about the properties and features of your motion controller.

Parameters

Input

Name	Type	Description
boardID	u8	assigned by Measurement & Automation Explorer
informationType	u32	type of information you want to retrieve

Output

Name	Type	Description
informationValue	u32	retrieved information

Parameter Discussion

informationType is the selector for the type of controller information you want. Legal values are defined as constants in the FlexMotion header files `motncnst.h` (for C/C++ users) and `motncnst.bas` (for Visual Basic users) and are listed in the following section.

informationValue is the returned information of the type you selected. Possible return values are listed in the following section in terms of constants defined in the FlexMotion header files.

informationType Constant	Possible informationValues
NIMC_BOARD_FAMILY (1100)	NIMC_FLEX_MOTION (0) NIMC_VALUE_MOTION (1)
NIMC_BOARD_TYPE (1120)	PC_SERVO_2A (7) PC_SERVO_4A (3) PC_STEP_2OX (8) PC_STEP_4OX (4) PC_STEP_2CX (9) PC_STEP_4CX (5) PC_FLEXMOTION_6C (16) PCI_7314 (30) PCI_7324 (29) PCI_7344 (28) PCI_SERVO_2A (17) PCI_SERVO_4A (11) PCI_STEP_2OX (18) PCI_STEP_4OX (12) PCI_STEP_2CX (19) PCI_STEP_4CX (13) PCI_FLEXMOTION_6C (24) PXI_7312 (22) PXI_7314 (20) PXI_7322 (23) PXI_7324 (21) PXI_7344 (27)
NIMC_BUS_TYPE (1130)	NIMC_ISA_BUS (0) NIMC_PCI_BUS (1) NIMC_PXI_BUS (2)
NIMC_CLOSED_LOOP_CAPABLE (1150)	NIMC_TRUE (1) NIMC_FALSE (0)
NIMC_NUM_AXES (1510)	Number of axes on the controller
NIMC_BOOT_VERSION (3010) ¹	Version-build code (MMmmbbbb)
NIMC_FIRMWARE_VERSION (3020)	Version-build code (MMmmbbbb)
NIMC_DSP_VERSION (3030)	Version-build code (MMmmbbbb)
NIMC_FPGA_VERSION (3040)	Version-build code (MMmmbbbb)
NIMC_FPGA2_VERSION (3050)	Version-build code (MMmmbbbb)
NIMC_FLEXMOTION_BOARD_CLASS (2030)	NIMC_FLEX_6C (0) NIMC_FLEX_7344 (1)
¹ This input value was used in FlexMotion software 4.0. It is not a valid value in the current version of FlexMotion.	

Using This Function

The *Get Motion Board Information* function returns selected information about ValueMotion and FlexMotion controllers including controller type and family, bus type, number of axes, and so on.

FlexMotion also has four information types for retrieving the version numbers and release dates of the firmware segments loaded in the onboard Flash ROM. All firmware segments are field upgradable using the **Update Firmware** option in Measurement & Automation Explorer. Versions are returned in a version-build code format:

Version-build code = *MMmmbbb*

where *MM* = the major version number,
mm = the minor version number, and
bbb = the build number.

You can use this information to verify that your FlexMotion controller has the latest firmware downloaded on it.

flex_get_motion_board_name

Get Motion Board Name

Format

status=flex_get_motion_board_name (boardID, charArray, sizeOfArray)

Purpose

Gets the motion controller name as an ASCII character array.

Parameters

Input

Name	Type	Description
boardID	u8	assigned by Measurement & Automation Explorer

Input/Output

Name	Type	Description
sizeOfArray	u32	size of character array

Output

Name	Type	Description
charArray	[i8]	character array

Parameter Discussion

sizeOfArray is the number of characters in the controller name plus one for the NULL string terminator. As an input, this I/O parameter specifies the size of the allocated array. If **sizeOfArray** is insufficient, a NIMC_insufficientSizeError is returned as the status of the function, and the required character array size (including space for the NULL terminator) is returned in the **sizeOfArray** parameter. If **sizeOfArray** is sufficient, a NIMC_noError is returned as the status of the function, the name is copied into the character array, and the number of bytes copied (plus one for the NULL terminator) is returned in the **sizeOfArray** parameter.

charArray is an array of ASCII characters containing the name of the controller. The FlexMotion software places the name of the controller, referenced by boardID, in the character array, if there is sufficient space. You must allocate space for this array before calling this function.

Using This Function

The *Get Motion Board Name* function returns the name of the controller as an ASCII character array. You must allocate space for this array on the host computer before calling this function.

If NULL (or 0) is passed in the **charArray** parameter, the size of a character array required to hold the controller name is returned in the **sizeOfArray** parameter. You can use this feature when you want to allocate only the memory necessary to hold the controller name. This function is then called twice: once to get the required array size, and once again to actually retrieve the name.

The number of characters required for the character array is always one more than the actual number of characters in the controller name due to the NULL terminator at the end of the string. For example, the controller name PXI-7324 is eight characters long, so you must provide a 9-byte character array to hold this name. **sizeOfArray** must be nine or greater as an input, and upon successful copy of the controller name, a value of nine is placed in **sizeOfArray**.

flex_read_err_msg_rtn

Read Error Message

Format

status = flex_read_err_msg_rtn (boardID, commandID, resourceID, errorCode)

Purpose

Reads the most recent modal error from the Error Message Stack.

Parameters

Input

Name	Type	Description
boardID	u8	assigned by Measurement & Automation Explorer

Output

Name	Type	Description
commandID	u16	command ID number
resourceID	u16	resource ID number
errorCode	u16	error code

Parameter Discussion

commandID is the command ID of the function that caused the error.

resourceID is the resource ID involved in the error.

errorCode is the code for the error condition.

Using This Function

The *Read Error Message* function retrieves the most recent modal error from the Error Message Stack and returns it through the Return Data Buffer to the host.



Note See Appendix A, *Error Codes*, for a description of error codes and possible causes.

When a modal error occurs, the command ID, resource ID, and error code are automatically stored in the Error Message Stack and the Error Message (Err Msg) bit in the Communication Status Register is set to indicate that one or more errors are present on the stack.

Modal errors are defined as errors that are not detected at the time of function execution.

These errors can occur for a number of reasons including: bad command ID, bad axis, vector space or resource ID, data out of range, function not valid in the present operating mode, and so on. A common source of modal errors is improperly constructed function calls stored in an onboard program. When the program is run, the errors generate modal error messages.



Note For a description of modal and non-modal errors, refer to Chapter 4, [Software Overview](#).

The Error Message Stack functions as a last-in-first-out (LIFO) buffer so that the most recent error is available immediately. You can read older errors with additional calls to this function. When the stack is empty, the Error Message (Err Msg) bit in the Communication Status Register is reset.

Example

An application program running on the host computer monitors the Communication Status Register to check for errors. If the Error Message bit is set, the program sends a [Read Error Message](#) function to the controller and then reacts to the error information returned.

Depending upon the type of error and/or the function and resource involved, the appropriate action is taken. You can check the Error Message bit again to see if any previous errors were missed.

Normally, if the application program is functioning correctly, errors are not generated. The Error Message Stack is most useful during initial application debug and for handling special conditions.

Onboard Programming Functions

This chapter contains detailed descriptions of functions used to load, execute, and save onboard programs. The functions are arranged alphabetically by function name.

FlexMotion offers a rich set of programming functions and features that allow you to write and execute autonomous programs that are completely independent from the host computer. FlexMotion has the capability of executing up to 10 simultaneous motion programs in a preemptive, real-time multitasking environment.

This extremely powerful feature is designed for real-time applications that need tight synchronization and/or minimum latency from a motion or other I/O event and fast command execution. You can execute the entire FlexMotion function set from onboard programs. In addition, programs support basic math and data operation functions on general-purpose variables. Onboard programs also offer event-based functions such as Jump to Label on Condition and Wait on Condition, which allow you to sequence and make decisions in your programs. Programs can even start and stop other programs.

Implementing part or all of your motion application as an onboard program or programs offloads the host computer from handling these real-time events. Onboard programs can also isolate your application from the host computer non-real-time operating system. Only bus power is required to correctly execute an onboard program once it is started.

Programs can be run from RAM or optionally saved to non-volatile Flash ROM. Saved programs are therefore available for execution at any future time, even after power cycles.

This chapter has a main section and two subsections, one on object management and the other on data operations. The main section covers functions to begin and end program storage and to control program execution. The *Object Management Functions* section covers functions to organize, annotate, and save program objects to ROM. The *Data Operations Functions* section covers math functions on general-purpose variables.

As a quick reference, a summary of the entire FlexMotion function API is in Appendix B, *FlexMotion Functions*.

flex_begin_store

Begin Program Storage

Format

status = flex_begin_store (boardID, program)

Purpose

Begins a program storage session.

Parameters

Input

Name	Type	Description
boardID	u8	assigned by Measurement & Automation Explorer
program	u8	program number

Parameter Discussion

program is the program number. Valid program numbers are 0x01 through 0xFF (1 through 255).

Using This Function

The *Begin Program Storage* function initiates program storage in RAM. Once begun, all subsequent functions are stored in an object buffer and not executed until the program is run with the *Run Program* function. This memory storage continues until you execute the *End Program Storage* function. You can store only one program at a time.

The size and number of programs is completely flexible. It is ultimately limited by the 32 total memory objects in the Object Registry or by total available memory, whichever is reached first.

The FlexMotion-6C controller has 32 KB of RAM plus 32 KB of ROM for program and object storage. You can run programs from either RAM or ROM, but you cannot split programs between the two. With an average command size of 10 bytes, a single program can be as large as 3,200 commands. Conversely, the FlexMotion-6C controller can simultaneously execute 10 programs, five from RAM and five from ROM, each 640 functions long.

The 7344 controller has 64 KB of RAM plus 128 KB of ROM (divided into two 64 KB sectors) for program and object storage. You can run programs from either RAM or ROM, but you cannot split programs between the two, and you cannot split programs between the two 64 KB ROM sectors. With an average command size of 10 bytes, a single program can be as

large as 6,400 commands. As another example, the 7344 controller can simultaneously execute 10 programs, five from RAM and five from ROM, with each program up to 1,280 commands long.

Attempting to store more than 32 programs generates an error. Similarly, an error is generated if you run out of memory during program storage. Both of these cases are extremely unlikely.

flex_end_store

End Program Storage

Format

status = flex_end_store (boardID, program)

Purpose

Ends a program storage session.

Parameters

Input

Name	Type	Description
boardID	u8	assigned by Measurement & Automation Explorer
program	u8	program number

Parameter Discussion

program is the program number. Valid program numbers are 0x01 through 0xFF (1 through 255).

Using This Function

The *End Program Storage* function ends memory storage of the program. All subsequent functions are executed normally. You can save a program to non-volatile memory (ROM) using the *Object Memory Management* function.

flex_insert_program_label

Insert Program Label

Format

status = flex_insert_program_label (boardID, labelNumber)

Purpose

Inserts a label in a program.

Parameters

Input

Name	Type	Description
boardID	u8	assigned by Measurement & Automation Explorer
labelNumber	u16	arbitrary label number

Parameter Discussion

labelNumber is any arbitrary label number from 1 to 65,535.

Using This Function

The *Insert Program Label* function marks a location in the sequence of a program. The label number identifies this location and uses it in the *Jump to Label on Condition* function. Label numbers are arbitrary and do not have to follow a numerical sequence.

flex_jump_label_on_condition

Jump to Label on Condition

Format

status = flex_jump_label_on_condition (boardID, resource, condition, mustOn, mustOff, matchType, labelNumber)

Purpose

Inserts a conditional jump in a program.

Parameters

Input

Name	Type	Description
boardID	u8	assigned by Measurement & Automation Explorer
resource	u8	axis, vector space or other resource
condition	u16	qualifying condition for the jump
mustOn	u8	bitmap of bits that must be True
mustOff	u8	bitmap of bits that must be False
matchType	u16	selector for type of match required
labelNumber	u16	label number to jump to

Parameter Discussion

resource is the axis control, vector space control, or other resource involved in the condition.

condition is the qualifying condition for the jump.

condition Constant	condition Value
NIMC_CONDITION_LESS_THAN	0
NIMC_CONDITION_EQUAL	1
NIMC_CONDITION_LESS_THAN_OR_EQUAL	2
NIMC_CONDITION_GREATER_THAN	3
NIMC_CONDITION_NOT_EQUAL	4
NIMC_CONDITION_GREATER_THAN_OR_EQUAL	5
NIMC_CONDITION_TRUE	6

condition Constant	condition Value	Valid resource
NIMC_CONDITION_HOME_FOUND	7	N/A
NIMC_CONDITION_INDEX_FOUND	8	N/A
NIMC_CONDITION_HIGH_SPEED_CAPTURE	9	0 (axes) or 0x20 (encoders)
NIMC_CONDITION_POSITION_BREAKPOINT	10	0 (axes) or 0x20 (encoders)
Reserved	11	N/A
NIMC_CONDITION_VELOCITY_THRESHOLD	12	N/A
NIMC_CONDITION_MOVE_COMPLETE	13	N/A
NIMC_CONDITION_PROFILE_COMPLETE	14	N/A
NIMC_CONDITION_BLEND_COMPLETE	15	0 (axes) or 0x10 (vector spaces)
NIMC_CONDITION_MOTOR_OFF	16	N/A
NIMC_CONDITION_HOME_INPUT_ACTIVE	17	N/A
NIMC_CONDITION_LIMIT_INPUT_ACTIVE	18	N/A
NIMC_CONDITION_SOFTWARE_LIMIT_ACTIVE	19	N/A
NIMC_CONDITION_PROGRAM_COMPLETE	20	program
NIMC_CONDITION_IO_PORT_MATCH	21	I/O port 1 or 2

mustOn is the bitmap of bits that must be True to satisfy the condition.

D7	D6	D5	D4	D3	D2	D1	D0
mustOn 7	mustOn 6	mustOn 5	mustOn 4	mustOn 3	mustOn 2	mustOn 1	mustOn 0

For D0 through D7:

- 1 = Bit must be True
- 0 = Don't care (default)

mustOff is the bitmap of bits that must be False to satisfy the condition.

D7	D6	D5	D4	D3	D2	D1	D0
mustOff 7	mustOff 6	mustOff 5	mustOff 4	mustOff 3	mustOff 2	mustOff 1	mustOff 0

For D0 through D7:

- 1 = Bit must be False
- 0 = Don't care (default)

matchType selects the type of match required for the bitmap.

matchType Constant	matchType Value
NIMC_MATCH_ALL	0
NIMC_MATCH_ANY	1

NIMC_MATCH_ANY means that a match of any bit (logical OR) is sufficient to satisfy the condition while NIMC_MATCH_ALL requires a complete pattern match (logical AND) of all bits.

labelNumber is the arbitrary label number to jump to. Valid label numbers are from 1 to 65,535.

Using This Function

The *Jump to Label on Condition* function controls the flow of execution in a stored program by defining a conditional jump to any label within the program. In addition to condition codes set as the result of a previous data operations function, you can test virtually any instantaneous status of axes or resources to decide whether to jump or not.

There are two distinct groups of conditions. The first group, conditions 0 through 6, test the result of the most recent logical, mathematical or data transfer operations function. For these

conditions, the resource, **mustOn**, **mustOff**, and **matchType** parameters are not required and their values are ignored.



Note You can program unconditional jumps by setting the condition to NIMC_CONDITION_TRUE (6).

The second group, conditions 7 and above, test a specific multi-axis, multi-vector space, multi-encoder, program, motion I/O, or general-purpose I/O status. Where applicable, you can select the desired resource with the resource parameter.

NIMC_CONDITION_PROGRAM_COMPLETE is similar to the first condition group in that **mustOn**, **mustOff**, and **matchType** parameters are not required and their values are ignored. You set resource equal to the desired program number to test. The balance of the conditions in this group test status bitmaps and function similar to each other as described in the remainder of this section.

The **mustOn**, **mustOff**, and **matchType** parameters work together to define a bitmap of True and False bits that must be matched to satisfy the condition. The **matchType** parameter allows you to select between an OR match, where any matching bit is sufficient, and an AND match, where all status bits must match the True/False bitmap defined by **mustOn** and **mustOff**.

Using the MustOn/MustOff protocol gives you tri-state control over each match bit: True, False or Don't care. A one (1) in a bit location of the MustOn bitmap sets the match bit to True, while a one (1) in the corresponding location of the MustOff bitmap resets the match bit to False. A zero (0) in either bitmap has no affect, so leaving both the MustOn and MustOff bits at zero defines the bit as Don't care. If you set both the MustOn and MustOff bits to one (1), it is interpreted as a MustOn condition and the match bit is set to True.

The NIMC_CONDITION_LIMIT_INPUT_ACTIVE and NIMC_CONDITION_SOFTWARE_LIMIT_ACTIVE conditions create a combined status bitmap where if either the forward or reverse limit is active, the bit is True.

Example

To perform a conditional jump to label 99 if either axis 3 is move complete or axis 5 is still moving (move not complete), call the *Jump to Label on Condition* function with the following parameters:

condition = NIMC_CONDITION_MOVE_COMPLETE (13)

mustOn = 0x08, which corresponds to the following bitmap

D7	D6	D5	D4	D3	D2	D1	D0
mustOn 7	mustOn 6	mustOn 5	mustOn 4	mustOn 3	mustOn 2	mustOn 1	mustOn 0
0	0	0	0	1	0	0	0

mustOff = 0x20, which corresponds to the following bitmap

D7	D6	D5	D4	D3	D2	D1	D0
mustOff 7	mustOff 6	mustOff 5	mustOff 4	mustOff 3	mustOff 2	mustOff 1	mustOff 0
0	0	1	0	0	0	0	0

matchType = NIMC_MATCH_ANY (1)

labelNumber = 99

In this example, the move complete status of axes 1, 2, 4, and 6 are don't care and the **matchType** is set to match either axis 3 move complete (On) or axis 5 move not complete (Off).

flex_load_delay

Load Program Delay

Format

status = flex_load_delay (boardID, delayTime)

Purpose

Loads a delay into a program sequence.

Parameters

Input

Name	Type	Description
boardID	u8	assigned by Measurement & Automation Explorer
delayTime	u32	delay time in milliseconds

Parameter Discussion

delayTime is the desired delay in milliseconds. The range is from 1 to $2^{31}-1$ ms.

Using This Function

The *Load Program Delay* function suspends program execution for the number of milliseconds loaded. Program execution resumes after the delay. Delays can be as short as one or two milliseconds or as long as hundreds of hours.

flex_pause_prog

Pause/Resume Program

Format

status = flex_pause_prog (boardID, program)

Purpose

Pauses a running program or resumes execution of a paused program.

Parameters

Input

Name	Type	Description
boardID	u8	assigned by Measurement & Automation Explorer
program	u8	program number

Parameter Discussion

program is the program number. Valid program numbers are 0x01 through 0xFF (1 through 255).

Using This Function

The *Pause/Resume Program* function suspends execution of a running program or resumes execution of a paused program.

A program can pause or resume another program and can also pause (but not resume) itself.



Note Pausing a program does not affect a move already started and in progress. It does not implement a *Stop Motion* function.

Any run-time (modal) error in a program automatically pauses the program in addition to generating the error message. For information about errors and error handling, refer to the *Read Error Message* function and Chapter 4, *Software Overview*.

A program can also automatically pause if you execute a *Stop Motion* function from the host computer on an axis or axes under control of the onboard program. In these cases, the program pauses when it attempts to execute a *Start Motion* or *Blend Motion* function on the stopped axes. This automatic pause also applies when the stop is due to a limit, home, software limit, or following error condition.

You can effectively single-step through an onboard program by having the program pause itself after every function, and then resuming the program from the host computer.

flex_read_program_status

Read Program Status

Format

status = flex_read_program_status (boardID, program, returnVector)

status = flex_read_program_status_rtn (boardID, program, programStatus)

Purpose

Reads the status of an onboard program.

Parameters

Input

Name	Type	Description
boardID	u8	assigned by Measurement & Automation Explorer
program	u8	program number
returnVector	u8	destination for the return data

Output

Name	Type	Description
programStatus	u16	status of specified program

Parameter Discussion

program is the program number. Valid program numbers are 0x01 through 0xFF (0 through 255).

returnVector indicates the desired destination for the return data generated by this function. Available returnVectors include return data to the host (0xFF) and return data to a variable (0x01 through 0x78).



Note The suffix `_rtn` on the function indicates that the data should be returned to the host. When this calling convention is used, no **returnVector** is required.

programStatus is the status of the specified program. Possible values are as follows.

Value	Definition
0	NIMC_PROGRAM_DONE
1	NIMC_PROGRAM_PLAYING
2	NIMC_PROGRAM_PAUSED
3	NIMC_PROGRAM_STORING

Using This Function

This function can be used to determine the state of an onboard program.

flex_run_prog

Run Program

Format

status = flex_run_prog (boardID, program)

Purpose

Runs a previously stored program.

Parameters

Input

Name	Type	Description
boardID	u8	assigned by Measurement & Automation Explorer
program	u8	program number

Parameter Discussion

program is the program number. Valid program numbers are 0x01 through 0xFF (0 through 255).

Using This Function

The *Run Program* function initiates execution of the functions stored in the selected program. You can run programs out of either RAM or ROM. You can simultaneously run up to ten (10) programs in the preemptive, multitasking environment of the FlexMotion controller.

A program can run another program but you cannot have a program run itself. Attempting to store a recursive *Run Program* function in a program generates an error and does not store the function.

flex_set_status_momo

Set User Status MOMO

Format

`status = flex_set_status_momo (boardID, mustOn, mustOff)`

Purpose

Controls the user status bits in the Move Complete Status (MCS) register.

Parameters

Input

Name	Type	Description
boardID	u8	assigned by Measurement & Automation Explorer
mustOn	u8	bitmap of user status bits to be forced True
mustOff	u8	bitmap of user status bits to be forced False

Parameter Discussion

mustOn is the bitmap of user status bits to be forced True.

D7	D6	D5	D4	D3	D2	D1	D0
mustOn Sts15	mustOn Sts14	mustOn Sts13	0	0	0	0	0

D5 through D7:

1 = User status bit forced True

0 = User status bit unchanged (default)

mustOff is the bitmap of user status bits to be forced False.

D7	D6	D5	D4	D3	D2	D1	D0
mustOff Sts15	mustOff Sts14	mustOff Sts13	0	0	0	0	0

D5 through D7:

1 = User status bit forced False

0 = User status bit unchanged (default)

Using This Function

The *Set User Status MOMO* function controls the upper three bits in the Move Complete Status (MCS) register using the mustOn/MustOff protocol. You can use this function in programs to report special conditions back to the host computer by setting and resetting one or more of these bits. Refer to the *Read Move Complete Status* function for more information on using the MCS register for high-speed polling.

Using the MustOn/MustOff protocol allows you to set or reset individual user status bits without affecting the other user status bits. This gives you tri-state control over each bit: True, False, or Unchanged. A one (1) in a bit location of the MustOn bitmap sets the user status bit high, while a one (1) in the corresponding location of the MustOff bitmap resets the user status bit low. A zero (0) in either bitmap has no affect, so leaving both the MustOn and MustOff bits at zero is effectively a hold, and the state of the user status bit is unchanged. If you set both the MustOn and MustOff bits to one (1), it is interpreted as a MustOn condition and the user status bit is set high.

Example

After a conditional jump in a program, you want the program to flag the host with a success code. This can be accomplished by storing the Set User Status MOMO with **mustOn** = 0xA0 and **mustOff** = 0x40. This forces user status bits 13 and 15 True and user status bit 14 low. A subsequent poll of the MCS register returns **motionCompleteStatus** = 0xC07E, which corresponds to the following bitmap.

D15	D14	D13	D12	D11	D10	D9	D8	D7	D6	D5	D4	D3	D2	D1	D0
Sts 15	Sts 14	Sts 13	XXX	XXX	XXX	XXX	XXX	XXX	MC 6	MC 5	MC 4	MC 3	MC 2	MC 1	XXX
1	0	1	0	0	0	0	0	0	1	1	1	1	1	1	0

flex_stop_prog

Stop Program

Format

`status = flex_stop_prog (boardID, program)`

Purpose

Stops a running program.

Parameters

Input

Name	Type	Description
boardID	u8	assigned by Measurement & Automation Explorer
program	u8	program number

Parameter Discussion

program is the program number. Valid program numbers are 0x01 through 0xFF (1 through 255).

Using This Function

The *Stop Program* function terminates execution of a running program. You cannot resume a stopped program but you can re-run the program from the beginning.

A program can stop another program but you cannot have a program stop itself. Attempting to store a recursive *Stop Program* function in a program generates an error and does not store the function.



Note Stopping a program does not affect a move already started and in progress. It does not implement a *Stop Motion* function.

flex_wait_on_condition

Wait on Condition

Format

status = flex_wait_on_condition (boardID, resource, waitType, condition, mustOn, mustOff, matchType, timeOut, returnVector)

Purpose

Inserts a conditional wait in a program.

Parameters

Input

Name	Type	Description
boardID	u8	assigned by Measurement & Automation Explorer
resource	u8	axis, vector space or other resource
waitType	u16	selector for type of wait
condition	u16	qualifying condition to end the wait
mustOn	u8	bitmap of bits that must be True
mustOff	u8	bitmap of bits that must be False
matchType	u16	selector for type of match required
timeOut	u16	timeout value in 100 millisecond increments
returnVector	u8	destination for the return data

Parameter Discussion

resource is the axis, vector space, or other resource involved in the condition.

waitType is the selector for the type of wait to perform.

waitType Constant	waitType Value
NIMC_WAIT	0
NIMC_WAIT_OR	1

NIMC_WAIT_OR allows you to combine multiple, unrelated wait conditions into one wait where the program is waiting for condition 1 OR condition 2 OR condition 3 and so on.

condition is the qualifying condition to end the wait.

condition Constant	condition Value	Valid resource
NIMC_CONDITION_HOME_FOUND	7	N/A
NIMC_CONDITION_INDEX_FOUND	8	N/A
NIMC_CONDITION_HIGH_SPEED_CAPTURE	9	0 (axes) or 0x20 (encoders)
NIMC_CONDITION_POSITION_BREAKPOINT	10	0 (axes) or 0x20 (encoders)
Reserved	11	N/A
NIMC_CONDITION_VELOCITY_THRESHOLD	12	N/A
NIMC_CONDITION_MOVE_COMPLETE	13	N/A
NIMC_CONDITION_PROFILE_COMPLETE	14	N/A
NIMC_CONDITION_BLEND_COMPLETE	15	0 (axes) or 0x10 (vector spaces)
NIMC_CONDITION_MOTOR_OFF	16	N/A
NIMC_CONDITION_HOME_INPUT_ACTIVE	17	N/A
NIMC_CONDITION_LIMIT_INPUT_ACTIVE	18	N/A
NIMC_CONDITION_SOFTWARE_LIMIT_ACTIVE	19	N/A
NIMC_CONDITION_PROGRAM_COMPLETE	20	program
NIMC_CONDITION_IO_PORT_MATCH	21	I/O port 1 or 2



Note Conditions 0 through 6 are not applicable to waits and generate an error.

mustOn is the bitmap of bits that must be True to satisfy the condition.

D7	D6	D5	D4	D3	D2	D1	D0
mustOn 7	mustOn 6	mustOn 5	mustOn 4	mustOn 3	mustOn 2	mustOn 1	mustOn 0

For D0 through D7:

1 = Bit must be True

0 = Don't care (default)

mustOff is the bitmap of bits that must be False to satisfy the condition.

D7	D6	D5	D4	D3	D2	D1	D0
mustOff 7	mustOff 6	mustOff 5	mustOff 4	mustOff 3	mustOff 2	mustOff 1	mustOff 0

For D0 through D7:

1 = Bit must be False

0 = Don't care (default)

matchType selects the type of match required for the bitmap.

matchType Constant	matchType Value
NIMC_MATCH_ALL	0
NIMC_MATCH_ANY	1

NIMC_MATCH_ANY means that a match of any bit (logical OR) is sufficient to satisfy the condition while NIMC_MATCH_ALL requires a complete pattern match (logical AND) of all bits.

timeOut is the wait timeout value in 100 millisecond increments. The range is 0 to 65,535 for a maximum timeout of over 100 minutes.

returnVector indicates the desired destination for the return data generated by this function. Available returnVectors include return data to the host (0xFF), return data to a variable (0x01 through 0x78), and don't return data (0).

Using This Function

The *Wait on Condition* function controls the flow of execution in a stored program. It suspends program execution and waits until the specified condition is met or the timeout expires. When the condition is met, program execution is resumed with the next function after the *Wait on Condition*.

If the timeout expires before the condition is met, an error is generated and the program goes into the paused state. For information about resuming a paused program, see the [Pause/Resume Program](#) function.

If you set a timeout of zero, the condition must already be true or an error is generated.

You can wait on virtually any instantaneous status of axes, vector spaces, encoders, programs, motion I/O, or general-purpose I/O. Where applicable, you can select the desired resource with the resource parameter.

When waiting on a program with the NIMC_CONDITION_PROGRAM_COMPLETE condition, **mustOn**, **mustOff**, and **matchType** parameters are not required and their values are ignored. You set resource equal to the desired program number to wait on. The balance of the conditions test status bitmaps and function similar to each other as described in the remainder of this section.

The **mustOn**, **mustOff**, and **matchType** parameters work together to define a bitmap of True and False bits that must be matched to satisfy the condition. The **matchType** parameter allow you to select between an OR match, where any matching bit is sufficient, and an AND match, where all status bits must match the True/False bitmap defined by MustOn and MustOff.

Using the MustOn/MustOff protocol gives you tri-state control over each match bit: True, False or Don't care. A one (1) in a bit location of the MustOn bitmap sets the match bit to True, while a one (1) in the corresponding location of the MustOff bitmap resets the match bit to False. A zero (0) in either bitmap has no affect, so leaving both the MustOn and MustOff bits at zero defines the bit as Don't care. If you set both the MustOn and MustOff bits to one (1), it is interpreted as a MustOn condition and the match bit is set to True.

The NIMC_CONDITION_LIMIT_INPUT_ACTIVE and NIMC_CONDITION_SOFTWARE_LIMIT_ACTIVE conditions create a combined status bitmap where if either the forward or reverse limit is active, the bit is True.

When the returnVector is set to anything other than zero (0), the condition code and status bitmap that satisfied the condition are returned to the destination specified, either to a variable or the host computer, as two 16-bit words (u16). In the host computer, they can then be read from the RDB with the [Communicate](#) function. This feature is useful when debugging programs.

Waits are one of the most powerful and useful features on the FlexMotion controller. While a program is suspended waiting for a condition, FlexMotion is not wasting CPU cycles on it. The preemptive multitasking real-time operating system (RTOS) on the FlexMotion controller suspends the task until the condition is met or the timeout expires. This feature allows up to 10 programs to be running simultaneously with little impact on function execution performance.

To perform a conditional wait on two unrelated conditions, store the *Wait on Condition* function twice—the first with **waitType** = NIMC_WAIT_OR and the second with **waitType** = NIMC_WAIT.



Note Two sequential *Wait on Condition* functions both with **waitType** = NIMC_WAIT effectively implement a Wait AND, because both wait conditions must evaluate successfully before program execution is resumed.

Example

In program one, you want to wait until axes 1 through 4 have found home or until program two is complete. To accomplish this, store a *Wait on Condition* function with the following parameters:

waitType = NIMC_WAIT_OR

condition = NIMC_CONDITION_HOME_FOUND (7)

mustOn = 0x1E, which corresponds to the following bitmap

D7	D6	D5	D4	D3	D2	D1	D0
mustOn 7	mustOn 6	mustOn 5	mustOn 4	mustOn 3	mustOn 2	mustOn 1	mustOn 0
0	0	0	1	1	1	1	0

mustOff = 0x00, which corresponds to the following bitmap

D7	D6	D5	D4	D3	D2	D1	D0
mustOff 7	mustOff 6	mustOff 5	mustOff 4	mustOff 3	mustOff 2	mustOff 1	mustOff 0
0	0	0	0	0	0	0	0

matchType = NIMC_MATCH_ALL (0)

timeOut = 100 (timeout after 10 s)

returnVector = 0 (throw the status away)

Immediately follow this with a second *Wait on Condition* function with the following parameters:

resource = 2 (for program two)

waitType = NIMC_WAIT

condition = NIMC_CONDITION_PROGRAM_COMPLETE (20)

timeOut = 100 (timeout after 10 s)

returnVector = 0 (throw the status away)

In this example, the home found status of axes 5 and 6 is don't care.

Object Management Functions

This subsection contains detailed descriptions of functions to organize, annotate, and save program objects to Flash ROM. These advanced functions are primarily used for applications that require non-volatile program storage. You can run programs out of RAM without using any of these functions.

These functions are arranged alphabetically by function name. As a quick reference, a summary of the entire FlexMotion function API is in Appendix B, *FlexMotion Functions*.

flex_load_description

Load Memory Object Description

Format

status = flex_load_description (boardID, object, description)

Purpose

Loads a ASCII text description for a program or other memory object.

Parameters

Input

Name	Type	Description
boardID	u8	assigned by Measurement & Automation Explorer
object	u8	program or other memory object
description	[i8]	ASCII character array describing the object

Parameter Discussion

object is a program or other memory object stored in onboard RAM or ROM.

description is an ASCII character array of up to 32 characters that describes the object.

Using This Function

The *Load Memory Object Description* function loads a text description for a program or other memory object. The ASCII text description is useful as a quick reminder of the contents or purpose of a program or other memory object stored in memory.



Note This function must be executed while the object is still in RAM. Once the object is saved to ROM, its description cannot be changed.

The description is limited to 32 characters; extra characters are ignored. You can retrieve the stored description with the *Read Memory Object Description* function.

flex_object_mem_manage

Object Memory Management

Format

status = flex_object_mem_manage (boardID, object, operation)

Purpose

Saves, deletes, or frees programs or other memory objects in RAM and ROM.

Parameters

Input

Name	Type	Description
boardID	u8	assigned by Measurement & Automation Explorer
object	u8	program or other memory object
operation	u16	operation to perform on the object

Parameter Discussion

object is a program or other memory object stored in onboard RAM or ROM.

operation is the operation to perform on the memory object.

operation Constant	operation Value
NIMC_OBJECT_SAVE	0
NIMC_OBJECT_DELETE	1
NIMC_OBJECT_FREE	2

Using This Function

The *Object Memory Management* function is used to save to ROM, delete from ROM, or free from RAM, a program or other memory object. Objects saved to non-volatile Flash ROM are available for use at any future time, even after power cycles.

To save an object to ROM, call this function with **operation** = NIMC_OBJECT_SAVE. The object is copied to ROM and exists in both RAM and ROM until the next power cycle. When that occurs, the RAM image is erased and the ROM version persists.

To remove an object from ROM, call this function with **operation** = NIMC_OBJECT_DELETE. The object is deleted from both ROM and RAM (if it still exists in RAM).

Once you have saved an object to ROM, you can free up its space in RAM by calling this function with **operation** = NIMC_OBJECT_FREE. This has no effect on the copy in ROM but deletes the image in RAM, making more memory available for storing additional programs or other objects.



Note You cannot save or delete a program while any other program is running. Also, you cannot free a program while it is running. In addition, you cannot save or delete a program when any motor is moving. Attempting to execute this function in these cases generates an error. Saving or deleting a program takes 2 to 4 seconds.

The FlexMotion-6C controller has 32 KB of RAM plus 32 KB of ROM for program and object storage. You can run programs from either RAM or ROM, but you cannot split programs between the two. With an average command size of 10 bytes, a single program can be as large as 3,200 commands. Conversely, the FlexMotion-6C controller can simultaneously execute 10 programs, five from RAM and five from ROM, each 640 functions long.

The 7344 controller has 64 KB of RAM plus 128 KB of ROM (divided into two 64 KB sectors) for program and object storage. You can run programs from either RAM or ROM, but you cannot split programs between the two, and you cannot split programs between the two 64 KB ROM sectors. With an average command size of 10 bytes, a single program can be as large as 6,400 commands. As another example, the 7344 controller can simultaneously execute 10 programs, five from RAM and five from ROM, with each program up to 1,280 commands long.

flex_read_description_rtn

Read Memory Object Description

Format

status = flex_read_description_rtn (boardID, object, description)

Purpose

Reads the ASCII text description for a program or other memory object. This ASCII text description was load with the [Load Memory Object Description](#) function and is useful for a quick reference or reminder of the contents or function of an array or program stored in memory.

Parameters

Input

Name	Type	Description
boardID	u8	assigned by Measurement & Automation Explorer
object	u8	program or other memory object

Output

Name	Type	Description
description	[i8]	ASCII character array describing the object

Parameter Discussion

object is a program or other memory object stored in onboard RAM or ROM.

description is an ASCII character array of up to 32 characters that describes the object.

Using This Function

The [Read Memory Object Description](#) function returns the ASCII text description for a program or other memory object. The ASCII text description, previously loaded with the [Load Memory Object Description](#) function, is useful as a quick reminder of the contents or purpose of a program or other memory object stored in memory.

flex_read_registry_rtn

Read Object Registry

Format

status = flex_read_registry_rtn (boardID, index, registryRecord)

Purpose

Reads a data record for a memory object from the Object Registry.

Parameters

Input

Name	Type	Description
boardID	u8	assigned by Measurement & Automation Explorer
index	u8	registry record number

Output

Name	Type	Description
registryRecord	REGISTRY FAR *	data record containing information about the memory object

Parameter Discussion

index is the registry record number. The range for index is 0 to 31.

registryRecord is the data record containing object information in the following structure:

```
struct {
    u16 device; // Object number
    u16 type; // Object type
    u32 pstart; // Start address in RAM or ROM
    u32 size; // Size of object in words
} REGISTRY;
```

Object type tells you the type of object stored. Presently only objects of program type are supported. The start address and object size are returned in hex. Size is in number or 16-bit words.

Using This Function

The *Read Object Registry* function returns a registry record for an object from the Object Registry. The Object Registry contains information on all objects stored in memory. You can store up to 32 objects in RAM and/or ROM. Each time an object is stored, a new record is created to keep track of it.

Registry records are referenced by index and each call to this function returns information on the referenced object. The index is not the same as the object number. You can use up to 255 unique object numbers (0x01 through 0xFF) but only 32 objects can be stored in memory at one time.

Data Operations Functions

This subsection contains detailed descriptions of the available math functions on general-purpose variables. Variables can be loaded, added, multiplied, ANDed, and so on before being used as data in a motion control function.

General-purpose variables are 32 bits long and can be used either signed (i32) or unsigned (u32). All functions in this section operate on 32-bit values and return 32-bit values. You must be careful to avoid overflow and underflow conditions. For example, multiplying two 32-bit variables and returning the result to a 32-bit variable might overflow and wrap around.

Smaller sized data is right aligned within a 32-bit variable. Bitwise logical functions always assume this alignment and return similarly aligned results.

Many FlexMotion functions can take input data from a general-purpose variable by pointing to the variable with the input vector parameter. Similarly, all read functions can return data to a general-purpose variable by using the return vector parameter. See Chapter 4, *Software Overview*, for a detailed description of input and return vectors.

All data operation functions set condition codes (less than, equal to or greater than zero) depending on the result of the operation. Your program can test these conditions with the *Jump to Label on Condition* function. Executing a data operations function with a return vector of zero (0) tells the program to set the condition code and then throw the resulting data away. In this way, you can use all the data operations functions as tests for conditional branching.

These functions are arranged alphabetically by function name. As a quick reference, a summary of the entire FlexMotion function API is in Appendix B, *FlexMotion Functions*.

flex_add_vars

Add Variables

Format

status = flex_add_vars (**boardID**, **variable1**, **variable2**, **returnVector**)

Purpose

Adds the values in the two variables and returns the result.

Parameters

Input

Name	Type	Description
boardID	u8	assigned by Measurement & Automation Explorer
variable1	u8	first operand
variable2	u8	second operand
returnVector	u8	destination for the result

Parameter Discussion

variable1 is the variable holding of the first operand. Valid variables are 0x01 through 0x78.

variable2 is the variable holding the second operand. Valid variables are 0x01 through 0x78.

returnVector indicates the desired destination for the result of this function. Available returnVectors include return data to the host (0xFF), return data to a variable (0x01 through 0x78), and don't return data (0).

Using This Function

The *Add Variables* function adds the values in the two variables and returns the result to the destination specified by the **returnVector**.

returnVector → value = **variable1** → value + **variable2** → value

The result can be returned to a new variable or one of the two input variables, returned to the host computer or thrown away. In all cases the condition codes are set according to the resulting value, GREATER THAN, LESS THAN, or EQUAL to zero.

flex_and_vars

AND Variables

Format

status = flex_and_vars (**boardID**, **variable1**, **variable2**, **returnVector**)

Purpose

Performs a bitwise AND of the values in the two variables and returns the result.

Parameters

Input

Name	Type	Description
boardID	u8	assigned by Measurement & Automation Explorer
variable1	u8	first operand
variable2	u8	second operand
returnVector	u8	destination for the result

Parameter Discussion

variable1 is the variable holding of the first operand. Valid variables are 0x01 through 0x78.

variable2 is the variable holding the second operand. Valid variables are 0x01 through 0x78.

returnVector indicates the desired destination for the result of this function. Available returnVectors include return data to the host (0xFF), return data to a variable (0x01 through 0x78), and don't return data (0).

Using This Function

The *AND Variables* function performs a bitwise logical AND of the values in the two variables and returns the result to the destination specified by the **returnVector**.

returnVector → value = **variable1** → value AND **variable2** → value

The result can be returned to a new variable or one of the two input variables, returned to the host computer, or thrown away. In all cases the EQUAL condition code is set True if the result equals zero (all bits low) and False if any bit is set. The GREATER THAN and LESS THAN codes are also set but can be confusing after logical bitwise operations.

Example

If the values in **variable1** and **variable2** are 0x0000 1234 and 0x0000 EEEE, respectively, the result of the bitwise AND is 0x0000 0224 which is NOT EQUAL to zero.

flex_div_vars

Divide Variables

Format

status = flex_div_vars (**boardID**, **variable1**, **variable2**, **returnVector**)

Purpose

Divides the value in the first variable by the value in the second variable and returns the result.

Parameters

Input

Name	Type	Description
boardID	u8	assigned by Measurement & Automation Explorer
variable1	u8	dividend
variable2	u8	divisor
returnVector	u8	destination for the result

Parameter Discussion

variable1 is the variable holding of the dividend. Valid variables are 0x01 through 0x78.

variable2 is the variable holding the divisor. Valid variables are 0x01 through 0x78.

returnVector indicates the desired destination for the result of this function. Available returnVectors include return data to the host (0xFF), return data to a variable (0x01 through 0x78), and don't return data (0).

Using This Function

The *Divide Variables* function divides the value in the first variable by the value in the second variable and returns the result to the destination specified by the **returnVector**.

returnVector → value = **variable1** → value/**variable2** → value

The result can be returned to a new variable or one of the two input variables, returned to the host computer or thrown away. In all cases the condition codes are set according to the resulting value, GREATER THAN, LESS THAN, or EQUAL to zero.



Note This function does an integer divide and the remainder is lost.

flex_load_var

Load Constant to Variable

Format

status = flex_load_var (boardID, value, variable1)

Purpose

Loads a constant value into a variable.

Parameters

Input

Name	Type	Description
boardID	u8	assigned by Measurement & Automation Explorer
value	i32	value to be loaded into the variable
variable1	u8	variable to be loaded

Parameter Discussion

value is the value to be loaded into the variable.

variable1 is the variable to be loaded. Valid variables are 0x01 through 0x78.

Using This Function

The *Load Constant to Variable* function loads a constant value into the selected variable.

variable1 → value = constant value

The condition codes are set according to the loaded value, GREATER THAN, LESS THAN, or EQUAL to zero.

flex_lshift_var

Logical Shift Variable

Format

status = flex_lshift_var (**boardID**, **variable1**, **logicalShift**, **returnVector**)

Purpose

Performs a logical shift on the value in a variable and returns the result.

Parameters

Input

Name	Type	Description
boardID	u8	assigned by Measurement & Automation Explorer
variable1	u8	variable holding the value to be shifted
logicalShift	i8	number of bits to shift
returnVector	u8	destination for the result

Parameter Discussion

variable1 is the variable holding the value to be shifted. Valid variables are 0x01 through 0x78.

logicalShift is the number of bits to shift. A positive logicalShift value shifts variable1 to the left and a negative value shifts variable1 to the right. The shift range is -31 through +31 bits.

returnVector indicates the desired destination for the result of this function. Available returnVectors include return data to the host (0xFF), return data to a variable (0x01 through 0x78), and don't return data (0).

Using This Function

The *Logical Shift Variable* function performs a logical shift on the value in the selected variable and returns the result to the destination specified by the **returnVector**.

For positive **logicalShift** values:

$$\mathbf{returnVector} \rightarrow \text{value} = \mathbf{variable1} \rightarrow \text{value} \ll (\mathbf{logicalShift})$$

For negative **logicalShift** values:

$$\text{returnVector} \rightarrow \text{value} = \text{variable1} \gg (-\text{logicalShift})$$

The result can be returned to a new variable or to the input variable, returned to the host computer or thrown away. In all cases the condition codes are set according to the resulting value, GREATER THAN, LESS THAN, or EQUAL to zero.

This function actually performs an arithmetic rather than logical shift if the variable is a signed 32-bit value (i32). Negative values are sign-extended when shifted to the right. You can use this function to perform division or scaling of signed or unsigned numbers. In this case the function effectively performs the following:

$$\text{returnVector} = \text{variable1} \times 2^{(\text{logicalShift})}$$

Example 1

If the value in **variable1** is 0x0000 F002 and **logicalShift** = -1, this function returns 0x00007801.

Example 2

If the value in **variable1** is 0xFFFF F002 and **logicalShift** = -1, this function returns 0xFFFFF801. The sign of the value is preserved by sign-extension.

flex_mult_vars

Multiply Variables

Format

status = flex_mult_vars (**boardID**, **variable1**, **variable2**, **returnVector**)

Purpose

Multiplies the values in the two variables and returns the result.

Parameters

Input

Name	Type	Description
boardID	u8	assigned by Measurement & Automation Explorer
variable1	u8	first operand
variable2	u8	second operand
returnVector	u8	destination for the result

Parameter Discussion

variable1 is the variable holding of the first operand. Valid variables are 0x01 through 0x78.

variable2 is the variable holding the second operand. Valid variables are 0x01 through 0x78.

returnVector indicates the desired destination for the result of this function. Available returnVectors include return data to the host (0xFF), return data to a variable (0x01 through 0x78), and don't return data (0).

Using This Function

The *Multiply Variables* function multiplies the values in the two variables and returns the result to the destination specified by the **returnVector**.

returnVector → value = **variable1** → value × **variable2** → value

The result can be returned to a new variable or one of the two input variables, returned to the host computer or thrown away. In all cases the condition codes are set according to the resulting value, GREATER THAN, LESS THAN, or EQUAL to zero.



Note Be careful when multiplying two large values. The result can overflow and wrap around. An error is not generated when an overflow occurs.

flex_not_var

Invert Variable

Format

status = flex_not_var (**boardID**, **variable1**, **returnVector**)

Purpose

Performs a bitwise inversion (NOT) on the value in a variable and returns the result.

Parameters

Input

Name	Type	Description
boardID	u8	assigned by Measurement & Automation Explorer
variable1	u8	variable to be inverted
returnVector	u8	destination for the result

Parameter Discussion

variable1 is the location of the variable to be inverted. Valid variables are 0x01 through 0x78.

returnVector indicates the desired destination for the result of this function. Available returnVectors include return data to the host (0xFF), return data to a variable (0x01 through 0x78), and don't return data (0).

Using This Function

The *Invert Variable* function performs a bitwise logical NOT on the value in the selected variable and returns the result to the destination specified by the **returnVector**.

$$\mathbf{returnVector} \rightarrow \text{value} = \sim(\mathbf{variable1} \rightarrow \text{value})$$

The result can be returned to a new variable or to the input variable, returned to the host computer or thrown away. In all cases the EQUAL condition code is set True if the result equals zero (all bits low) and False if any bit is set. The GREATER THAN and LESS THAN codes are also set but can be confusing after logical bitwise operations.

Example

If the value in **variable1** is 0x0000 5A5A, the result of the bitwise NOT is 0xFFFF A5A5. The EQUAL condition code is set to False.

flex_or_vars

OR Variables

Format

status = flex_or_var (boardID, variable1, variable2, returnVector)

Purpose

Performs a bitwise OR of the values in the two variables and returns the result.

Parameters

Input

Name	Type	Description
boardID	u8	assigned by Measurement & Automation Explorer
variable1	u8	first operand
variable2	u8	second operand
returnVector	u8	destination for the result

Parameter Discussion

variable1 is the variable holding of the first operand. Valid variables are 0x01 through 0x78.

variable2 is the variable holding the second operand. Valid variables are 0x01 through 0x78.

returnVector indicates the desired destination for the result of this function. Available returnVectors include return data to the host (0xFF), return data to a variable (0x01 through 0x78), and don't return data (0).

Using This Function

The *OR Variables* function performs a bitwise logical OR of the values in the two variables and returns the result to the destination specified by the **returnVector**.

returnVector → value = **variable1** → value OR **variable2** → value

The result can be returned to a new variable or one of the two input variables, returned to the host computer or thrown away. In all cases the EQUAL condition code is set True if the result equals zero (all bits low) and False if any bit is set. The GREATER THAN and LESS THAN codes are also set but can be confusing after logical bitwise operations.

Example

If the values in **variable1** and **variable2** are 0x5A5A 1234 and 0x8282 0000, respectively, the result of the bitwise OR is 0xDADA 1234, which is NOT EQUAL to zero.

flex_read_var and flex_read_var_rtn

Read Variable

Format

status = flex_read_var (boardID, variable1, returnVector)

status = flex_read_var_rtn (boardID, variable1, value)

Purpose

Reads the value of a variable and returns the result.

Parameters

Input

Name	Type	Description
boardID	u8	assigned by Measurement & Automation Explorer
variable1	u8	variable to be read
returnVector	u8	destination for the return data

Output

Name	Type	Description
value	i32	value of the variable

Parameter Discussion

variable1 is the variable to be read. Valid variables are 0x01 through 0x78.

returnVector indicates the desired destination for the result of this function. Available returnVectors include return data to the host (0xFF), return data to a variable (0x01 through 0x78), and don't return data (0).



Note The suffix `_rtn` on the function indicates that the data should be returned to the host. When this calling convention is used, no **returnVector** is required.

value is the value of the variable.

Using This Function

The *Read Variable* function reads the value of the selected variable and returns it to the destination specified by the **returnVector**.

returnVector → value = **variable1** → value

or

value = **variable1** → value

The condition codes are set according to the value read: GREATER THAN, LESS THAN, or EQUAL to zero.

flex_sub_vars

Subtract Variables

Format

status = flex_sub_vars (boardID, variable1, variable2, returnVector)

Purpose

Subtracts the value of second variable from the value of the first variable and returns the result.

Parameters

Input

Name	Type	Description
boardID	u8	assigned by Measurement & Automation Explorer
variable1	u8	first operand
variable2	u8	second operand
returnVector	u8	destination for the result

Parameter Discussion

variable1 is the variable holding of the first operand. Valid variables are 0x01 through 0x78.

variable2 is the variable holding the second operand. Valid variables are 0x01 through 0x78.

returnVector indicates the desired destination for the result of this function. Available returnVectors include return data to the host (0xFF), return data to a variable (0x01 through 0x78), and don't return data (0).

Using This Function

The *Subtract Variables* function subtracts the value of second variable from the value of the first variable and returns the result to the destination specified by the **returnVector**.

returnVector → value = **variable1** → value – **variable2** → value

The result can be returned to a new variable or one of the two input variables, returned to the host computer or thrown away. In all cases the condition codes are set according to the resulting value, GREATER THAN, LESS THAN, or EQUAL to zero.

This function is often used to compare two values prior to executing a conditional jump with the *Jump to Label on Condition* function. In this case, the result is typically thrown away by setting **returnVector** = 0.

flex_xor_vars

Exclusive OR Variables

Format

status = flex_xor_vars (boardID, variable1, variable2, returnVector)

Purpose

Performs a bitwise Exclusive OR (XOR) of the values in the two variables and returns the result.

Parameters

Input

Name	Type	Description
boardID	u8	assigned by Measurement & Automation Explorer
variable1	u8	first operand
variable2	u8	second operand
returnVector	u8	destination for the result

Parameter Discussion

variable1 is the variable holding of the first operand. Valid variables are 0x01 through 0x78.

variable2 is the variable holding the second operand. Valid variables are 0x01 through 0x78.

returnVector indicates the desired destination for the result of this function. Available returnVectors include return data to the host (0xFF), return data to a variable (0x01 through 0x78), and don't return data (0).

Using This Function

The *Exclusive OR Variables* function performs a bitwise logical XOR of the values in the two variables and returns the result to the destination specified by the **returnVector**.

returnVector → value = **variable1** → value XOR **variable2** → value

The result can be returned to a new variable or one of the two input variables, returned to the host computer or thrown away. In all cases the EQUAL condition code is set True if the result equals zero (all bits low) and False if any bit is set. The GREATER THAN and LESS THAN codes are also set but can be confusing after logical bitwise operations.

Example

If the values in **variable1** and **variable2** are 0x5A5A 1234 and 0xFFFF 4321, respectively, the result of the bitwise XOR is 0xA5A5 5115, which is NOT EQUAL to zero.

Advanced Functions

This chapter contains detailed descriptions of advanced functions used to control the communications between the host computer and FlexMotion controller. The functions are arranged alphabetically by function name.

These functions allow you to check the status of communications, control host interrupts, clear the Return Data Buffer (RDB), and manage the low-level communications to the controller. You will typically not have to use any of these functions because the default configuration is correct for almost all applications. These functions are available to handle special applications.

This chapter also describes two utility functions that are regularly used but are different from the rest of the FlexMotion API in that they are not typically included in application code: *Clear Power Up Status* and *Save Default Parameters*.

As a quick reference, a summary of the entire FlexMotion function API is in Appendix B, *FlexMotion Functions*.

flex_clear_pu_status

Clear Power Up Status

Format

`status = flex_clear_pu_status (boardID)`

Purpose

Clears the Power-Up status bit and boots up the controller, making it ready to accept functions.

Parameters

Input

Name	Type	Description
boardID	u8	assigned by Measurement & Automation Explorer

Using This Function

Whenever the FlexMotion controller is reset by a power cycle, watchdog timeout, or other means, the controller is suspended in a Power-Up state and a Power-Up status bit in the Communications Status Register (CSR) is set. The *Clear Power Up Status* function is used to clear this bit and ready the controller for motion control communications.

You cannot execute other motion control functions until the Power-Up status bit has been cleared by using this function. This lockout ensures that you are aware of the occurrence of an unexpected reset, as in the case of a watchdog timeout.

You can include this function once at the beginning of an initialization routine, but should not be included in other routines to avoid the possibility of restarting an application unexpectedly after a power cycle or watchdog timeout.

When the FlexMotion controller is in the Power-Up state, the Move Complete Status (MCS) register contains a power-up code that describes why the controller is in the Power-Up state. To access this code, execute the *Read Move Complete Status* function. The following table describes the power-up codes.

Code	Reset Type	Cause
0x80	Bus reset	Normal PC power cycle
0x40	Power-Up reset	Normal PC power cycle
0x20	Watchdog timeout	Fatal internal error

Code	Reset Type	Cause
0x08	Shutdown	Shutdown input active; refer to the <i>Enable Shutdown</i> function
0x02	Software reset	Firmware download

flex_communicate

Communicate

Format

status = flex_communicate (boardID, mode, wordCount, resource, command, data, vector)

Purpose

Sends and receives command packets to/from the FlexMotion controller.

Parameters

Input

Name	Type	Description
boardID	u8	assigned by Measurement & Automation Explorer
mode	u8	selects send command only, read RDB only or both send command and read RDB
wordCount	u8	number of 16-bit words in the command packet
vector	u8	source of the data for this function or destination for the return data

Input/Output

Name	Type	Description
resource	u8	axis, vector space, encoder, ADC channel, program or other resource
command	u16	command ID for the function
data	[u16]	array of data to/from the controller

Parameter Discussion

mode selects the communications mode for the function.

mode Constant	mode Value	Description
NIMC_SEND_COMMAND	0	send the command packet only
NIMC_SEND_AND_READ	1	send the command packet and then read the RDB
NIMC_READ_RDB	2	read the RDB only

wordCount is the number of 16-bit words in the command packet. Appendix B, *FlexMotion Functions*, lists the word counts for all the FlexMotion API functions.

resource is the axis, vector space, encoder, ADC channel, DAC, program, or other resource on the FlexMotion controller.

command is the command ID for the function. Appendix B, *FlexMotion Functions*, lists the command IDs for all the FlexMotion API functions.

data is an array of 16-bit data words. Depending upon mode, this data is either sent to the controller, received from the RDB or both.

vector is either an inputVector or a returnVector.

inputVector indicates the source of the data for this function. Available inputVectors include immediate (0xFF) or variable (0x01 through 0x78).

returnVector indicates the desired destination for the return data generated by this function. Available returnVectors include return data to the host (0xFF), return data to a variable (0x01 through 0x78), and don't return data (0).

Using This Function

The *Communicate* function provides a single entry point API for all FlexMotion commands. You can use *Communicate* to load parameters, read values, configure axes, start motion, and so on. You can access all FlexMotion features with either the *Communicate* function or with the individual API functions.

Communicate provides an alternate approach to motion control programming that is useful in some programming environments. You can specify any FlexMotion function with *Communicate* by supplying the appropriate command ID, resource and word count. Refer to

Appendix B, *FlexMotion Functions*, for a table of command IDs and word counts for each function.



Note *Communicate* in NIMC_SEND_AND_READ mode is functionally equivalent to the `_rtn` calling convention for individual read functions. The data is always returned to the host and no **inputVector** is required.

All FlexMotion read functions have two calling conventions: with and without the `_rtn` suffix. Without the `_rtn` suffix, the read function buffers the data in the Return Data Buffer. You then use *Communicate* in NIMC_READ_RDB mode to read one or more packets from this buffer.

Refer to your motion controller user manual for more information on low-level communications protocols and return data packets.

flex_enable_1394_watchdog

Enable 1394 Watchdog

Format

status = flex_enable_1394_watchdog (boardID, enableOrDisable)

Purpose

Enables or disables the watchdog timer on the 1394 motherboard.

Parameters

Input

Name	Type	Description
boardID	u8	assigned by Measurement & Automation Explorer
enableOrDisable	u8	enable or disable the watchdog timer

Parameter Discussion

enableOrDisable enables or disables the watchdog timer on the 1394 motherboard. Set this to NIMC_TRUE (1) to enable the watchdog timer and NIMC_FALSE (0) to disable the watchdog timer.

Using This Function

The *Enable 1394 Watchdog* function enables the communications watchdog timer on the FW-7344. If the FW-7344 is in an environment with severe electrostatic discharge (ESD) conditions, these ESD events can disrupt the host-to-controller communication.

When the watchdog timer is enabled, the motion control driver must access the watchdog timer every 10 seconds. If an event such as ESD disrupts this communication, the watchdog automatically resets the controller. If you do not enable the watchdog timer, you have to power cycle the FW-7344 to restore communication.

flex_enable_auto_start

Enable Auto Start

Format

status = flex_enable_auto_start (**boardID**, **enableOrDisable**, **programToExecute**)

Purpose

Allows you to automatically run a program when the controller powers up.

Parameters

Input

Name	Type	Description
boardID	u8	assigned by Measurement & Automation Explorer
enableOrDisable	u8	enable or disable auto start
programToExecute	u8	program number to execute

Parameter Discussion

enableOrDisable enables or disables the auto start feature. Set this to NIMC_TRUE (1) to enable auto start and NIMC_FALSE (0) to disable auto start.

programToExecute is the onboard program the controller will execute if the auto start feature is enabled. This should be a valid program number (1–255), that is stored to FLASH using the *Object Memory Management* function.

Using This Function

The *Enable Auto Start* function configures the controller to automatically start an onboard program on power up. Once auto start is enabled, the controller automatically executes the onboard program specified on the subsequent power up. The onboard program to be executed should be saved to FLASH using the *Object Memory Management* function before the controller is powered down. If the controller does not find a valid program that it can load, NIMC_autoStartFailedError is generated.



Note This function writes to onboard memory and hence it is not safe to execute when motors are in motion. Doing so will generate a NIMC_wrongModeError.

flex_enable_shutdown

Enable Shutdown

Format

status = flex_enable_shutdown (boardID)

Purpose

Enables the shutdown functionality of the controller.

Parameters

Input

Name	Type	Description
boardID	u8	assigned by Measurement & Automation Explorer

Using This Function

The *Enable Shutdown* function enables the controller to react to the shutdown input. When the shutdown input transitions from low to high, the controller goes into a shutdown state. The following actions take place in the shutdown state:

- All the axes are killed. (On servo axes, the control loop is disabled and the output DACs are zeroed, allowing frictional forces alone to stop the motion. On stepper axes, the stepper pulse generation is stopped. On both axis types, there is no trajectory profile. If enabled, the inhibit output is activated to inhibit (disable) the servo amplifier or stepper driver. You can enable the inhibit outputs and set their polarity as active high (noninverting) or active low (inverting) with the *Configure Inhibit Outputs* function.
- All the axes, encoders and ADCs are disabled.
- The DSP is disabled, which shuts down all control loop generation.
- All the digital IO is re-initialized to defaults. If the user has saved defaults using the *Save Default Parameters* function, the digital IO is re-initialized to the user defaults, else it is re-initialized to the factory defaults.
- All onboard programs that are executing are stopped.
- The controller does not accept any functions, except for the following ones:
 - Get Motion Board Information
 - Read Error Message
 - Enable Auto Start

The shutdown functionality is disabled by default. This functionality has to be enabled every time the controller is powered up. You should enable this feature only after the shutdown circuit has been properly configured and connected to the controller. Once shutdown has been enabled, it can be disabled only by resetting or power cycling the controller.



Note Once the controller has shut down, it has to be reset or power cycled before it can be used again.

flex_flush_rdb

Flush Return Data Buffer

Format

status = flex_flush_rdb (boardID)

Purpose

Clears the Return Data Buffer by deleting all of the buffered data.

Parameters

Input

Name	Type	Description
boardID	u8	assigned by Measurement & Automation Explorer

Using This Function

The *Flush Return Data Buffer* function clears the Return Data Buffer by repetitively reading the RDB until the buffer is empty. All return data packets in the RDB are deleted and nothing is returned by this function.

You typically use the *Flush Return Data Buffer* function after an error condition when the data in the Return Data Buffer is no longer valid or relevant. This function is also useful for flushing the RDB after a programming error has caused the buffer to become skewed. Buffer skew is when the data returned by a read function using the `_rtn` calling convention (such as `flex_read_pos_rtn`) does not return the expected data but rather returns data requested by a previous function.

Refer to your motion controller user manual for more information on low-level communications protocols and return data packets.

flex_read_csr_rtn

Read Communication Status

Format

status = flex_read_csr_rtn (boardID, csr)

Purpose

Reads the Communication Status Register (CSR).

Parameters

Input

Name	Type	Description
boardID	u8	assigned by Measurement & Automation Explorer

Output

Name	Type	Description
csr	u16	bitmap of communications status

Parameter Discussion

csr is the bitmap of communication status from the Communication Status Register.

D15	D14	D13	D12	D11	D10	D9	D8	D7	D6	D5	D4	D3	D2	D1	D0
XXX	XXX	XXX	XXX	XXX	XXX	XXX	XXX	HW Fail	Err Msg	PU Reset	Pkt Err	PIP	Int	RTS	RTR

For D0 Ready to Receive (RTR):

1 = Ready to receive a word from the host

0 = Not ready to receive (busy)

For D1 Ready to Send (RTS):

1 = Ready to send a word from the RDB to the host

0 = Not ready to send (RDB empty)

For D2 Interrupt (Int):

1 = Interrupt status

0 = Normal data

For D3 Packet In Process (PIP):

- 1 = Waiting for more words to finish the packet
- 0 = Idle

For D4 Packet Error (Pkt Err):

- 1 = Communication packet error
- 0 = No error

For D5 Power-Up Reset (PU Reset):

- 1 = Controller is in the Power-Up state
- 0 = Power-Up state has been cleared

For D6 Error Message (Err Msg):

- 1 = Modal error message pending
- 0 = No error

For D7 Hardware Failure (HW Fail):

- 1 = Fatal hardware error occurred
- 0 = No error

Using This Function

The *Read Communication Status* function performs a direct read of the Communication Status Register (CSR) on the FlexMotion controller. The CSR is a hardware register containing communication handshaking and error status bits. The FlexMotion software polls this register continuously when sending and receiving packets for handshaking and error checking purposes. Refer to your motion controller user manual for more information on low-level communication protocols and return data packets.

You can also call this function at any time to check the communication and error status. Because the CSR is always up to date and directly accessible over the computer bus, executing this function does not affect the operation of the FlexMotion controller itself.

flex_reset_defaults

Reset Default Parameters

Format

status = flex_reset_defaults (boardID)

Purpose

Resets the power-up defaults to the factory-default settings.

Parameters

Input

Name	Type	Description
boardID	u8	assigned by Measurement & Automation Explorer

Using This Function

The *Reset Default Parameters* function resets the power-up defaults to the factory-default settings for all important configuration, initialization, and trajectory parameters for use after subsequent power-up resets. When you execute this function, the default values for all parameters listed in Appendix C, *Default Parameters*, are saved to nonvolatile flash memory and become the power-up defaults.



Note The effect of this function is not realized until the next time the controller is powered up from a power-down state.

You only need to use this function if you have previously modified the power-up defaults using the *Save Default Parameters* function and want to revert back to the factory defaults.

flex_save_defaults

Save Default Parameters

Format

status = flex_save_defaults (boardID)

Purpose

Saves the current operating parameters as defaults.

Parameters

Input

Name	Type	Description
boardID	u8	assigned by Measurement & Automation Explorer

Using This Function

The *Save Default Parameters* function saves all important configuration, initialization, and trajectory parameters for use after subsequent power-up resets. When you execute this function, all parameters listed in Appendix C, *Default Parameters* are saved to nonvolatile flash memory and become the power-up defaults.



Note When the controller is powered up and the onboard processors boot, the defaults are automatically applied. There will be some time, however, between the controller powering up and the application of defaults.

If necessary, you can reinstate the factory-default parameters as the power-up defaults with the *Reset Default Parameters* function.

This function does not perform a complete state save. For proper and safe operation after power-up, certain parameters are always reset to their factory defaults to bring the controller back to a known safe state. Refer to Table C-1, *Default Parameters*, of Appendix C, *Default Parameters*, for a comprehensive list of all parameters stored by the *Save Default Parameters* function. Parameters not stored are left out by design and are typically reset to zero at power-up.



Note If you want to remember a parameter that is not included in this list, you can copy that parameter to a general-purpose variable and it will be saved with this function. You can then reset the parameter to your saved value with a program designed for this purpose.

flex_set_irq_mask

Set Interrupt Event Mask

Format

`status = flex_set_irq_mask (boardID, mask)`

Purpose

Selects the events that interrupt the host.

Parameters

Input

Name	Type	Description
boardID	u8	assigned by Measurement & Automation Explorer
mask	u16	bitmap of events to interrupt on

Parameter Discussion

mask is the interrupt event mask, the bitmap of events to interrupt on.

D15	D14	D13	D12	D11	D10	D9	D8	D7	D6	D5	D4	D3	D2	D1	D0
0	0	0	0	VT	BC	PC	0	0	0	HSC	BP	IO	MC	0	Err

For D0 Error Message Pending (Err):

1 = Interrupt when Error Message pending

0 = Do not interrupt

D1 is reserved

For D2 Move Complete (MC):

1 = Interrupt on Move Complete event

0 = Do not interrupt

For D3 GPIO Event (IO):

1 = Interrupt on general-purpose I/O event

0 = Do not interrupt

For D4 Breakpoint (BP):

- 1 = Interrupt on breakpoint event
- 0 = Do not interrupt

For D5 High-Speed Capture (HSC):

- 1 = Interrupt on high-speed capture event
- 0 = Do not interrupt

D6 through D8 are reserved

For D9 Program Complete (PC):

- 1 = Interrupt on Program Complete event
- 0 = Do not interrupt

For D10 Blend Complete (BC):

- 1 = Interrupt on Blend Complete event
- 0 = Do not interrupt

For D11 Velocity Threshold (VT):

- 1 = Interrupt on velocity threshold event
- 0 = Do not interrupt

D12 through D15 are reserved

The factory default value for **mask** is zero (0)—all interrupt events disabled.

Using This Function

The *Set Interrupt Event Mask* function configures the event types that interrupt the host computer when interrupts are enabled on the controller. Interrupts are an advanced method of synchronizing and communicating with the host computer but require an interrupt handler on the host to validate and process the interrupt.



Note Interrupts are supported under only Windows NT/98/95.

A typical FlexMotion application generates thousands of events. Rather than constantly interrupting the host on every event, this function allows you to mask off event types that are not relevant to your application. Doing this improves performance by reducing the number of interrupts the handler has to process and reject as irrelevant.

This function controls interrupt event types, not individual per axis or vector space events. Upon receiving an interrupt of a certain type, the interrupt handler must read the desired status from the FlexMotion controller to further resolve the event to the particular axis, vector space, program, and so on and then decide on the event reaction.

FlexMotion must have an interrupt line selected and enabled before any interrupts will be generated. This is done during controller configuration when FlexMotion is first installed in your system. Once an interrupt line is enabled, the *Set Interrupt Event Mask* function can be used to further configure the interrupting events.



Note To disable all interrupts on the fly, mask them all off by setting **mask** = 0. This has the same effect as reinstalling the controller with the interrupt line disabled.

Error Codes

This appendix summarizes the error codes returned by the FlexMotion software.

Each FlexMotion function returns a status that indicates whether the function executed successfully. A non-zero return status indicates that the function failed to execute. This non-zero value is an error code you can use to diagnose the error condition.

FlexMotion can also generate modal errors during operation that are not detected at the time of function execution. These modal errors are returned by the *Read Error Message* function as additional error codes.

Table A-1 lists all FlexMotion error codes and gives a brief description of the associated error conditions. For reference, the table also lists a symbolic constant corresponding to each numeric error code. These constants are defined in the FlexMotion header files `motnerr.h` (for C/C++ users) and `motnerr.bas` (for Visual Basic users).

Refer to Chapter 11, *Error & Utility Functions*, for detailed descriptions of the functions for error handling. Chapter 4, *Software Overview*, gives information on modal versus non-modal errors and on error handling techniques.

Table A-1. Error Codes Summary

Error Code	Symbolic Name	Description
0	NIMC_noError	No error.
1	NIMC_readyToReceiveTimeoutError	Ready to Receive Timeout. The controller is still not ready to receive commands after the specified timeout period. This error may occur if the controller is busy processing previous commands. If this error persists, even when the controller should not be busy, contact National Instruments.
2	NIMC_currentPacketError	Either this function is not supported by this type of controller, or the controller received an incomplete command packet and cannot execute the function.
3	NIMC_noReturnDataBufferError	No data in the Return Data Buffer. The kernel driver returns an error if it runs out of time waiting for the controller to return data to the Return Data Buffer. For FlexMotion controllers, this error can also be returned if the power-up state of the controller has not been cleared.
4	NIMC_halfReturnDataBufferError	Partial readback packet. The data returned by the controller is incomplete. The kernel driver timed out after getting partial data.
5	NIMC_boardFailureError	Most likely, your controller is not installed or configured properly. If this error persists when you know your controller is installed and configured properly, it indicates an internal hardware failure.

Table A-1. Error Codes Summary (Continued)

Error Code	Symbolic Name	Description
6	NIMC_badResourceIDOrAxisError	For ValueMotion, an invalid axis number was used. For FlexMotion, an invalid axis number or other resource ID (Vector Space, Encoder, I/O Port, and so on) was used.
7	NIMC_CIPBitError	A previous function is currently being executed, so the controller cannot accept this function until the previous function has completed. If this problem persists, try putting a delay between the offending commands.
8	NIMC_previousPacketError	The function called previous to this one is not supported by this type of controller.
9	NIMC_packetErrBitNotClearedError	Packet error bit not cleared by terminator (hardware error).
10	NIMC_badCommandError	Command ID not recognized. Invalid command sent to the controller (FlexMotion only).
11	NIMC_badReturnDataBufferPacketError	Corrupt readback data. The data returned by the motion controller is corrupt.
12	NIMC_badBoardIDError	Illegal board ID. You must use the board ID assigned to your controller in Measurement & Automation Explorer.
13	NIMC_packetLengthError	Command packet length is incorrect.
14	NIMC_closedLoopOnlyError	This command is valid only on closed-loop axes (closed-loop stepper and servo).
15	NIMC_returnDataBufferFlushError	Unable to flush the Return Data Buffer.

Table A-1. Error Codes Summary (Continued)

Error Code	Symbolic Name	Description
16	NIMC_servoOnlyError	This command is valid only on servo axes.
17	NIMC_stepperOnlyError	This command is valid only on stepper axes.
18	NIMC_closedLoopStepperOnlyError	This command is valid only on closed-loop stepper axes.
19	NIMC_noBoardConfigInfoError	Controller configuration information is missing or corrupt.
20	NIMC_countsNotConfiguredError	Steps/rev and/or counts/rev (in ValueMotion, lines/rev) not loaded for this axis.
21	NIMC_systemResetError	System reset did not occur in maximum time allowed.
22	NIMC_functionSupportError	This command is not supported by this controller or operating system.
23	NIMC_parameterValueError	One of the parameters passed into the function has an illegal value.
24	NIMC_motionOnlyError	Motion command sent to an Encoder board.
25	NIMC_returnDataBufferNotEmptyError	The Return Data Buffer is not empty. Commands that expect data returned from the controller cannot be sent until the Return Data Buffer is cleared.
26	NIMC_modalErrorsReadError	The Motion Error Handler.flx VI discovered modal error(s) in the modal error stack. These error(s) can be viewed in the Modal Error(s) Out Indicator/terminal of this VI.
27	NIMC_processTimeoutError	Under Windows NT, a function call made to the motion controller timed out waiting for driver access.

Table A-1. Error Codes Summary (Continued)

Error Code	Symbolic Name	Description
28	NIMC_insufficientSizeError	The resource is not large enough to supported the specified operation.
33	NIMC_badPointerError	A NULL pointer has been passed into a function inappropriately.
34	NIMC_wrongReturnDataError	Incorrect data has been returned by the controller. This data does not correspond to the expected data for the command sent to the controller.
35	NIMC_watchdogTimeoutError	A fatal error has occurred on the controller. You must reset the controller by power cycling your computer. Contact National Instruments technical support if this problem persists.
36	NIMC_invalidRatioError	A specified ratio is invalid.
37	NIMC_irrelevantAttributeError	The specified attribute is not relevant.
38	NIMC_internalSoftwareError	An unexpected error has occurred internal to the driver. Please contact National Instruments with the name of the function or VI that returned this error.
39	NIMC_1394WatchdogEnableError	The communication watchdog on the 1394 motherboard could not be started.
49	NIMC_downloadChecksumError	There was an error during check sum on a file being downloaded to the FlexMotion controller.
51	NIMC_firmwareDownloadError	Firmware download failed. Reset the controller and try downloading again.

Table A-1. Error Codes Summary (Continued)

Error Code	Symbolic Name	Description
52	NIMC_FPGAProgramError	Internal Error. The FPGA failed to program. Reset the controller and try again. If the problem persists, contact National Instruments technical support.
53	NIMC_DSPInitializationError	Internal Error. The DSP failed to initialize. Reset the controller and try again. If the problem persists, contact National Instruments technical support.
54	NIMC_corrupt68331FirmwareError	Corrupt onboard microprocessor firmware detected. Download new firmware.
55	NIMC_corruptDSPFirmwareError	Corrupt DSP firmware detected. Download new DSP firmware.
56	NIMC_corruptFPGAFirmwareError	Corrupt FPGA firmware detected. Download new FPGA firmware.
57	NIMC_interruptConfigurationError	Internal Error. Host interrupt configuration failed and interrupt support is disabled.
58	NIMC_IOInitializationError	Internal Error. The I/O structure on the controller failed to initialize. Reset the controller and try again. If the problem persists, contact National Instruments technical support.
59	NIMC_flashromCopyError	Error copying to the FLASH ROM.
60	NIMC_corruptObjectSectorError	The objects stored in FLASH ROM are corrupt.
73	NIMC_boardInShutDownStateError	The controller cannot accept this function, as it has been shut down.

Table A-1. Error Codes Summary (Continued)

Error Code	Symbolic Name	Description
74	NIMC_shutDownFailedError	The controller failed to shut down. This could be because it failed to disable the DACs, the encoders, or the ADCs, or because it could not reset the I/O back to user defaults.
75	NIMC_hostFIFOBufferFullError	Communication FIFO buffer between the host computer and the controller is full.
76	NIMC_noHostDataError	Communications error. The controller did not receive any data in the command packet from the host computer.
77	NIMC_corruptHostDataError	Communications error. The controller received corrupt data in the packet from the host computer.
78	NIMC_invalidFunctionDataError	Invalid data in the function.
79	NIMC_autoStartFailedError	The controller could not run the onboard program on auto start. When you enable auto start, make sure that you specify a valid program number and that the program is saved in FLASH ROM.
80	NIMC_returnDataBufferFullError	The Return Data Buffer on the controller is full.
83	NIMC_DSPXmitBufferFullError	Internal error. The transmit buffer of the DSP is full. Messages from DSP to the onboard microprocessor are being delayed or lost.
84	NIMC_DSPInvalidCommandError	Internal error. The DSP received an illegal command.
85	NIMC_DSPInvalidDeviceError	Internal error. The DSP received a command with an invalid Device ID.

Table A-1. Error Codes Summary (Continued)

Error Code	Symbolic Name	Description
92	NIMC_DSPXmitDataError	Internal error. The data returned by the DSP is incomplete or corrupt.
93	NIMC_DSPCommunicationsError	Internal error. A command from the onboard microprocessor to the DSP was corrupt and ignored.
95	NIMC_DSPCommunicationsTimeoutError	Internal error. There was an internal timeout while sending commands to the DSP.
96	NIMC_passwordError	The password used for this function is incorrect.
97	NIMC_mustOnMustOffConflictError	There is a conflict between the mustOn and mustOff values set for this function.
100	NIMC_IOEventCounterError	Problem with the I/O Event Counter.
102	NIMC_wrongIODirectionError	The I/O bit configuration does not agree with its port's direction setting.
103	NIMC_wrongIOConfigurationError	I/O bit configuration is not possible for that pin.
104	NIMC_outOfEventsError	Internal error. The number of events pending have reached the maximum allowed.
106	NIMC_outputDeviceNotAssignedError	No DAC or stepper output is assigned to this axis.
108	NIMC_PIDUpdateRateError	PID rate specified is too fast for the number of axes and/or encoders enabled.
109	NIMC_feedbackDeviceNotAssignedError	No primary feedback device (encoder or ADC) is assigned to a servo or closed-loop stepper axis.
113	NIMC_noMoreRAMError	No RAM available for object storage.

Table A-1. Error Codes Summary (Continued)

Error Code	Symbolic Name	Description
115	NIMC_jumpToInvalidLabelError	A <i>Jump to Label on Condition</i> function in a program had an invalid label.
116	NIMC_invalidConditionCodeError	Condition selected is invalid.
117	NIMC_homeLimitNotEnabledError	<i>Find Home</i> function cannot execute because the Home and/or Limit inputs are not enabled.
118	NIMC_findHomeError	<i>Find Home</i> was not successful because the motor stopped before the find home switch was found.
119	NIMC_limitSwitchActiveError	The desired move cannot be completed because the limit input is active in the direction of travel.
121	NIMC_positionRangeError	Absolute target position loaded would cause the move length to be out of the ± 31 bit range allowed for a single move segment.
122	NIMC_encoderDisabledError	The encoder is disabled. The encoder must be enabled to read it.
123	NIMC_moduloBreakpointError	The breakpoint value loaded exceeds the modulo range.
124	NIMC_findIndexError	<i>Find Index</i> sequence did not find the index successfully.
125	NIMC_wrongModeError	The function was not executed because it was attempted at an illegal time.
126	NIMC_axisConfigurationError	An axis cannot be configured while enabled. Disable the axis and then configure it.
127	NIMC_pointsTableFullError	The points table for cubic splining is full.

Table A-1. Error Codes Summary (Continued)

Error Code	Symbolic Name	Description
129	NIMC_axisDisabledError	A disabled axis has been commanded to move. Enable the axis before executing a move on it.
130	NIMC_memoryRangeError	An invalid memory location is being addressed on the controller.
131	NIMC_inPositionUpdateError	Internal error. The axis position could not be read for in-position verification.
132	NIMC_targetPositionUpdateError	Internal error. The DSP was too busy to update the target position.
133	NIMC_pointRequestMissingError	Internal error. The internal points request buffer is missing a request.
134	NIMC_internalSamplesMissingError	Internal error. The internal samples buffer is missing samples.
136	NIMC_eventTimeoutError	A wait operation timed out or a read function timed out.
137	NIMC_objectReferenceError	An attempt was made to reference a nonexistent program or other memory object.
138	NIMC_outOfMemoryError	Not enough FLASH ROM space to save this object.
139	NIMC_registryFullError	Object registry is full.
140	NIMC_noMoreProgramPlayerError	All program players (maximum 10) are in use storing/playing programs.
141	NIMC_programOverruleError	A <i>Start Motion</i> , <i>Blend Motion</i> , <i>Find Home</i> , or <i>Find Index</i> function being executed from an onboard program has been overruled by a <i>Stop Motion</i> function from the host computer. The program is left in the PAUSED state. Execute the <i>Pause/Resume Program</i> function to continue.

Table A-1. Error Codes Summary (Continued)

Error Code	Symbolic Name	Description
142	NIMC_followingErrorOVERRIDEError	A <i>Start Motion</i> , <i>Blend Motion</i> , <i>Find Home</i> , or <i>Find Index</i> function being executed from an onboard program has been overruled due to a following error condition. The program is left in the PAUSED state. Execute the <i>Pause/Resume Program</i> function to continue.
144	NIMC_illegalVariableError	An illegal general-purpose variable is being used.
145	NIMC_illegalVectorSpaceError	The vector space being used does not have enough axes assigned to it.
146	NIMC_noMoreSamplesError	There are no samples to read. Execute <i>Acquire Trajectory Data</i> before trying to read samples.
147	NIMC_slaveAxisKilledError	Gearing cannot be enabled because the slave axis is in a killed state. Issue a halt stop or decel stop with the <i>Stop Motion</i> function on the slave axis to energize it.
148	NIMC_ADCDisabledError	The ADC is disabled. The ADC channel must be enabled to read it.
149	NIMC_operationModeError	Axes that are a part of a vector space are either in velocity mode or have different operation modes.
150	NIMC_followingErrorOnFindHomeError	<i>Find Home</i> sequence did not find home successfully because the axis tripped on following error.
151	NIMC_invalidVelocityError	The vector velocity is not valid. The resulting angular velocity is out of range. Change the vector velocity for the arc move.

Table A-1. Error Codes Summary (Continued)

Error Code	Symbolic Name	Description
152	NIMC_invalidAccelerationError	The vector acceleration is not valid. The resulting angular acceleration is out of range. Change the vector acceleration for the arc move.
153	NIMC_samplesBufferFullError	Internal error. The internal samples buffer is full.
154	NIMC_illegalVectorError	The input or return vector being used is invalid.
155	NIMC_QSPIFailedError	Internal error. The internal QSPI serial bus failed and ADC values cannot be read.
157	NIMC_pointsBufferFullError	Internal error. The internal point request buffer is full.
158	NIMC_axisInitializationError	Internal Error. The internal axis data structures failed to initialize. Reset the controller and try again. If the problem persists, contact National Instruments technical support.
159	NIMC_encoderInitializationError	Internal Error. The internal encoder data structures failed to initialize. Reset the controller and try again. If the problem persists, contact National Instruments technical support.
160	NIMC_stepChannelInitializationError	Internal Error. The internal stepper output data structures failed to initialize. Reset the controller and try again. If the problem persists, contact National Instruments technical support.
161	NIMC_blendFactorConflictError	Axes, which are part of a vector space, have different blend factors. Make sure that all the axes in the vector space have the same blend factor.

Table A-1. Error Codes Summary (Continued)

Error Code	Symbolic Name	Description
162	NIMC_torqueOffsetError	The torque offset is outside of the torque limit range.
163	NIMC_invalidLimitRangeError	The negative (lower) limit is greater than or equal to the positive (upper) limit.

FlexMotion Functions

This appendix contains three tables that summarize the FlexMotion function parameters, list changes to the FlexMotion API, and give a ValueMotion to FlexMotion function cross reference.

Table B-1 summarizes the FlexMotion function parameters including the number of words in the command packet sent to the controller, whether or not the function takes a vector, and the Command ID. These parameters are required when using the *Communicate* function.

Table B-1. FlexMotion Function Summary

Function Name	Description	Word Count	Uses Vectors	Command ID
Axis & Resource Configuration Functions				
flex_config_axis	Configure Axis Resources	5	No	281
flex_config_mc_criteria	Configure Move Complete Criteria	6	No	285
flex_config_step_mode_pol	Configure Step Mode & Polarity	4	No	65
flex_config_vect_spc	Configure Vector Space	6	No	280
flex_enable_axes	Enable Axes	4	No	3
flex_load_counts_steps_rev	Load Counts/Steps per Revolution	4	No	406
flex_load_pid_parameters	Load All PID Parameters	11	Yes	32
flex_load_single_pid_parameter	Load Single PID Parameter	5	Yes	385
flex_load_vel_tc_rs	Configure Velocity Filter	5	Yes	45
flex_set_stepper_loop_mode	Set Stepper Loop Mode	5	No	381
Trajectory Control Functions				
flex_check_blend_complete_status	Check Blend Complete Status	N/A	—	—
flex_check_move_complete_status	Check Move Complete Status	N/A	—	—

Table B-1. FlexMotion Function Summary (Continued)

Function Name	Description	Word Count	Uses Vectors	Command ID
flex_load_acceleration	Load Acceleration/Deceleration	6	Yes	379
flex_load_follow_err	Load Following Error	4	Yes	47
flex_load_rpm	Load Velocity in RPM	7	Yes	371
flex_load_rpsps	Load Accel/Decel in RPS/sec	8	Yes	380
flex_load_target_pos	Load Target Position	5	Yes	39
flex_load_velocity	Load Velocity	5	Yes	391
flex_load_vs_pos	Load Vector Space Position	9	Yes	378
flex_read_axis_status/ flex_read_axis_status_rtn	Read per Axis Status	3	Yes	326
flex_read_blend_status/ flex_read_blend_status_rtn	Read Blend Status	3	Yes	291
flex_read_follow_err/ flex_read_follow_err_rtn	Read Following Error	3	Yes	48
flex_read_mcs_rtn	Read Move Complete Status	N/A	—	—
flex_read_pos/ flex_read_pos_rtn	Read Position	3	Yes	41
flex_read_rpm/ flex_read_rpm_rtn	Read Velocity in RPM	3	Yes	374
flex_read_trajectory_status/ flex_read_trajectory_status_rtn	Read Trajectory Status	4	Yes	386
flex_read_velocity/ flex_read_velocity_rtn	Read Velocity	3	Yes	392
flex_read_vs_pos/ flex_read_vs_pos_rtn	Read Vector Space Position	3	Yes	377
flex_reset_pos	Reset Position	7	Yes	42
flex_set_op_mode	Set Operation Mode	4	No	35
flex_wait_for_blend_complete	Wait for Blend Complete	N/A	—	—
flex_wait_for_move_complete	Wait for Move Complete	N/A	—	—

Table B-1. FlexMotion Function Summary (Continued)

Function Name	Description	Word Count	Uses Vectors	Command ID
Arc Functions				
flex_load_circular_arc	Load Circular Arc	13	Yes	290
flex_load_helical_arc	Load Helical Arc	11	Yes	375
flex_load_spherical_arc	Load Spherical Arc	13	Yes	290
Gearing Functions				
flex_config_gear_master	Configure Gear Master	4	No	30
flex_enable_gearing	Enable Gearing	4	No	4
flex_enable_gearing_single_axis	Enable Gearing Single Axis	4	No	396
flex_load_gear_ratio	Load Gear Ratio	6	Yes	31
Advanced Trajectory Functions				
flex_acquire_trajectory_data	Acquire Trajectory Data	6	No	292
flex_load_base_velocity	Load Base Velocity	4	Yes	28
flex_load_blend_fact	Load Blend Factor	4	Yes	36
flex_load_pos_modulus	Load Position Modulus	5	Yes	284
flex_load_rpm_thresh	Load Velocity Threshold in RPM	7	Yes	376
flex_load_scurve_time	Load S-Curve Time	4	Yes	287
flex_load_torque_lim	Load Torque Limit	7	Yes	62
flex_load_torque_offset	Load Torque Offset	5	Yes	63
flex_load_vel_threshold	Load Velocity Threshold	5	Yes	393
flex_load_velocity_override	Load Velocity Override	4	Yes	74
flex_read_dac/ flex_read_dac_rtn	Read DAC	3	Yes	64
flex_read_dac_limit_status/ flex_read_dac_limit_status_rtn	Read DAC Limit Status	3	Yes	60
flex_read_steps_gen/ flex_read_steps_gen_rtn	Read Steps Generated	3	Yes	66
flex_read_target_pos/ flex_read_target_pos_rtn	Read Target Position	3	Yes	40
flex_read_trajectory_data/ flex_read_trajectory_data_rtn	Read Trajectory Data	3	Yes	18

Table B-1. FlexMotion Function Summary (Continued)

Function Name	Description	Word Count	Uses Vectors	Command ID
Start & Stop Motion Functions				
flex_blend	Blend Motion	4	No	22
flex_start	Start Motion	4	No	21
flex_stop_motion	Stop Motion	5	No	384
Motion I/O Functions				
flex_configure_inhibits	Configure Inhibit Outputs	4	No	282
flex_enable_home_inputs	Enable Home Inputs	4	No	9
flex_enable_limits	Enable Limits	5	No	382
flex_load_sw_lim_pos	Load Software Limit Positions	7	Yes	29
flex_read_home_input_status/ flex_read_home_input_status_rtn	Read Home Input Status	3	Yes	10
flex_read_limit_status/ flex_read_limit_status_rtn	Read Limit Status	4	Yes	383
flex_set_home_polarity	Set Home Input Polarity	4	No	8
flex_set_inhibit_momo	Set Inhibit MOMO	4	No	11
flex_set_limit_polarity	Set Limit Input Polarity	4	No	5
Breakpoint Functions				
flex_enable_bp	Enable Breakpoint	4	No	322
flex_load_bp_modulus	Load Breakpoint Modulus	5	Yes	59
flex_load_pos_bp	Load Breakpoint Position	5	Yes	58
flex_read_breakpoint_status/ flex_read_breakpoint_status_rtn	Read Breakpoint Status	4	Yes	387
flex_set_bp_momo	Set Breakpoint Output MOMO	4	No	323
High-Speed Capture Functions				
flex_enable_hs_caps	Enable High-Speed Position Capture	4	No	324
flex_read_cap_pos/ flex_read_cap_pos_rtn	Read Captured Position	3	Yes	57
flex_read_hs_cap_status/ flex_read_hs_cap_status_rtn	Read High-Speed Capture Status	3	Yes	332

Table B-1. FlexMotion Function Summary (Continued)

Function Name	Description	Word Count	Uses Vectors	Command ID
flex_set_hs_cap_pol	Set High-Speed Capture Polarity	4	No	325
Find Home & Index Functions				
flex_find_home	Find Home	4	No	333
flex_find_index	Find Index	4	No	334
Analog & Digital I/O Functions				
flex_configure_pwm_output	Configure PWM Output	5	No	397
flex_enable_adcs	Enable ADCs	4	No	321
flex_enable_encoders	Enable Encoders	4	No	53
flex_load_dac	Load DAC	4	Yes	61
flex_load_pwm_duty	Load PWM Duty Cycle	4	Yes	316
flex_read_adc/ flex_read_adc_rtn	Read ADC	3	Yes	320
flex_read_encoder/ flex_read_encoder_rtn	Read Encoder Position	3	Yes	56
flex_read_port/ flex_read_port_rtn	Read I/O Port	3	Yes	319
flex_reset_encoder	Reset Encoder Position	5	Yes	68
flex_select_signal	Select Signal	5	No	402
flex_set_adc_range	Set ADC Range	4	No	401
flex_set_encoder_frequency	Configure Encoder Filter	4	No	77
flex_set_port_direction	Set I/O Port Direction	4	No	311
flex_set_port_momo	Set I/O Port MOMO	4	No	318
flex_set_port_pol	Set I/O Port Polarity	4	No	314
Error & Utility Functions				
flex_get_error_description	Get Error Description	N/A	—	—
flex_get_motion_board_info	Get Motion Board Information	N/A	—	—
flex_get_motion_board_name	Get Motion Board Name	N/A	—	—
flex_read_err_msg_rtn	Read Error Message	3	No	2

Table B-1. FlexMotion Function Summary (Continued)

Function Name	Description	Word Count	Uses Vectors	Command ID
Onboard Programming Functions				
flex_begin_store	Begin Program Storage	3	No	339
flex_end_store	End Program Storage	3	No	340
flex_insert_program_label	Insert Program Label	4	No	344
flex_jump_label_on_condition	Jump to Label on Condition	7	No	390
flex_load_delay	Load Program Delay	5	No	359
flex_pause_prog	Pause/Resume Program	3	No	342
flex_read_program_status/ flex_read_program_status_rtn	Read Program Status	3	Yes	395
flex_run_prog	Run Program	3	No	341
flex_set_status_momo	Set User Status MOMO	4	No	356
flex_stop_prog	Stop Program	3	No	343
flex_wait_on_condition	Wait on Condition	8	Yes	388
Object Management Functions				
flex_load_description	Load Memory Object Description	19	No	366
flex_object_mem_manage	Object Memory Management	4	No	389
flex_read_description_rtn	Read Memory Object Description	3	No	367
flex_read_registry_rtn	Read Object Registry	3	No	361
Data Operations Functions				
flex_add_vars	Add Variables	4	Yes	346
flex_and_vars	AND Variables	4	Yes	352
flex_div_vars	Divide Variables	4	Yes	349
flex_load_var	Load Constant to Variable	5	Yes	351
flex_lshift_var	Logical Shift Variable	4	Yes	357
flex_mult_vars	Multiply Variables	4	Yes	347
flex_not_var	Invert Variable	4	Yes	355
flex_or_vars	OR Variables	4	Yes	353

Table B-1. FlexMotion Function Summary (Continued)

Function Name	Description	Word Count	Uses Vectors	Command ID
flex_read_var/ flex_read_var_rtn	Read Variable	4	Yes	358
flex_sub_vars	Subtract Variables	4	Yes	348
flex_xor_vars	Exclusive OR Variables	4	Yes	354
Advanced Functions				
flex_clear_pu_status	Clear Power Up Status	3	No	258
flex_communicate	Communicate	variable	Yes	any
flex_enable_1394_watchdog	Enable 1394 Watchdog	N/A	No	255
flex_enable_auto_start	Enable Auto Start	4	No	404
flex_enable_shutdown	Enable Shutdown	3	No	405
flex_flush_rdb	Flush Return Data Buffer	N/A	—	—
flex_read_csr_rtn	Read Communication Status	N/A	—	—
flex_reset_defaults	Reset Default Parameters	3	No	403
flex_save_defaults	Save Default Parameters	3	No	283
flex_set_irq_mask	Set Interrupt Event Mask	4	No	269

To aid in converting a ValueMotion application to FlexMotion, Table B-2 lists each function in the ValueMotion API and gives the nearest FlexMotion function. Refer to the individual functions in both the ValueMotion and FlexMotion function references for detailed information on the functional and syntactic differences.

Table B-2. ValueMotion to FlexMotion Cross Reference

ValueMotion Function Name	FlexMotion Function Name	Descriptive Name
acquire_samples	flex_acquire_trajectory_data	Acquire Trajectory Data
begin_prestore	flex_begin_store	Begin Program Storage
communicate	flex_communicate	Communicate
enable_brk	flex_enable_bp	Enable Breakpoint
enable_io_trig	flex_wait_on_condition	Wait on Condition
enable_limits	flex_enable_limits flex_enable_home_inputs	Enable Limits Enable Home Inputs

Table B-2. ValueMotion to FlexMotion Cross Reference (Continued)

ValueMotion Function Name	FlexMotion Function Name	Descriptive Name
enable_pos_trig	flex_jump_label_on_condition	Jump to Label on Condition
end_prestore	flex_end_store	End Program Storage
find_home	flex_find_home	Find Home
find_index/ find_index_rdb	flex_find_index	Find Index
flush_rdb	flex_flush_rdb	Flush Return Data Buffer
get_board_type	flex_get_motion_board_info	Get Motion Board Information
get_motion_board_info	flex_get_motion_board_info	Get Motion Board Information
get_motion_board_name	flex_get_motion_board_name	Get Motion Board Name
in_pos	flex_config_mc_criteria	Configure Move Complete Criteria
kill_motion	flex_stop_motion	Stop Motion
load_accel	flex_load_acceleration	Load Acceleration/Deceleration
load_accel_fact	—	—
load_break_mod	flex_load_bp_modulus	Load Breakpoint Modulus
load_deriv_gain	flex_load_single_pid_parameter	Load Single PID Parameter
load_deriv_per	flex_load_single_pid_parameter	Load Single PID Parameter
load_fol_err	flex_load_follow_err	Load Following Error
load_intg_gain	flex_load_single_pid_parameter	Load Single PID Parameter
load_intg_lim	flex_load_single_pid_parameter	Load Single PID Parameter
load_pos_brk	flex_load_pos_bp	Load Breakpoint Position
load_pos_ref	—	—
load_pos_scale	—	—
load_prop_gain	flex_load_single_pid_parameter	Load Single PID Parameter
load_rot_counts	flex_load_pos_modulus	Load Position Modulus
load_rpm	flex_load_rpm	Load Velocity in RPM
load_rpsps	flex_load_rpsps	Load Accel/Decel in RPS/sec
load_steps_lines	flex_load_counts_steps_rev	Load Counts/Steps per Revolution
load_target_pos	flex_load_target_pos	Load Target Position
load_time_brk	—	—

Table B-2. ValueMotion to FlexMotion Cross Reference (Continued)

ValueMotion Function Name	FlexMotion Function Name	Descriptive Name
load_vel	flex_load_velocity	Load Velocity
load_vel_change	flex_load_velocity_override	Load Velocity Override
master_slave_cfg	flex_config_gear_master	Configure Gear Master
multi_start	flex_start	Start Motion
read_adc	flex_read_adc/ flex_read_adc_rtn	Read ADC
read_axis_stat/ read_axis_stat_rdb	flex_read_axis_status/ flex_read_axis_status_rtn	Read per Axis Status
read_csr	flex_read_csr_rtn	Read Communication Status
read_encoder/ read_encoder_rdb	flex_read_encoder/ flex_read_encoder_rtn	Read Encoder Position
read_gpio/ read_gpio_rdb	flex_read_port/ flex_read_port_rtn	Read I/O Port
read_io_port/ read_io_port_rdb	flex_read_hs_cap_status/ flex_read_hs_cap_status_rtn	Read High-Speed Capture Status
read_lim_stat/ read_lim_stat_rdb	flex_read_limit_status/ flex_read_limit_status_rtn flex_read_home_input_status/ flex_read_home_input_status_rtn	Read Limit Status Read Home Input Status
read_pos/ read_pos_rdb	flex_read_pos/ flex_read_pos_rtn	Read Position
read_rdb	flex_communicate	Communicate
read_rpm	flex_read_rpm/ flex_read_rpm_rtn	Read Velocity in RPM
read_steps_vel	flex_read_velocity/ flex_read_velocity_rtn	Read Velocity
read_vel/ read_vel_rdb	flex_read_velocity/ flex_read_velocity_rtn	Read Velocity
reset_pos	flex_reset_pos	Reset Position
send_command	flex_communicate	Communicate
set_base_vel	—	—
set_direction	flex_load_velocity flex_load_rpm	Load Velocity Load Velocity in RPM

Table B-2. ValueMotion to FlexMotion Cross Reference (Continued)

ValueMotion Function Name	FlexMotion Function Name	Descriptive Name
set_gpio	flex_set_port_momo	Set I/O Port MOMO
set_io_output	flex_set_bp_momo	Set Breakpoint Output MOMO
set_io_pol	flex_set_hs_cap_pol	Set High-Speed Capture Polarity
set_lim_pol	flex_set_limit_polarity	Set Limit Input Polarity
	flex_set_home_polarity	Set Home Input Polarity
set_loop_mode	flex_set_stepper_loop_mode	Set Stepper Loop Mode
set_portc_dir	flex_set_port_dir	Set I/O Port Direction
set_pos_mode	flex_set_op_mode	Set Operation Mode
set_rs_pulse	flex_config_mc_criteria	Configure Move Complete Criteria
set_scale_seq	—	—
set_step_mode_pol	flex_config_step_mode_pol	Configure Step Mode & Polarity
set_stop_mode	flex_stop_motion	Stop Motion
start_motion	flex_start	Start Motion
stop_motion	flex_stop_motion	Stop Motion
store_elc	flex_load_counts_steps_rev	Load Counts/Steps per Revolution
store_steps_rev	flex_load_counts_steps_rev	Load Counts/Steps per Revolution
trig_buff_delim	flex_wait_on_condition	Wait on Condition
trigger_io	flex_run_prog	Run Program



Default Parameters

This appendix lists all parameters that have default values.

When you execute the *Clear Power Up Status* function after a power-up reset, the FlexMotion controller is automatically reinitialized to a known state and all important configuration, initialization, and trajectory parameters are set to their default values.

FlexMotion ships with a set of factory defaults that are adequate for initial motion control development. You can change and save new power-up defaults with the *Save Default Parameters* function.

Table C-1 lists all of the parameters that have defaults. Parameters not listed are typically reset to zero (0). Velocity override is always reset to 100%.

At power-up reset, all axes are blend complete, profile complete (and move complete), all are motor off (killed) but are not tripped on the following error. In addition, the user status bits in the Move Complete Status register are all reset.

Table C-1. Default Parameters

Parameter	Factory Default
Axis & Resource Configuration Parameters	
Axis n primary feedback	Encoder n
Axis n secondary feedback	None (0)
Axis n primary output	DAC n
Axis n secondary output	None (0)
Move complete criteria	PC only (1)
Move complete deadband	1
Move complete delay	0
Move complete min pulse	0
Stepper mode and polarity	Inverting, Step, and Dir (5)

Table C-1. Default Parameters (Continued)

Parameter	Factory Default
Vector space n	No axes (0)
Enable axes	All disabled (0)
Counts per Revolution	2,000
Kp	100
Ki	0
Ilim	1,000
Kd	1,000
Td	2
Kv, Aff, Vff	0
Steps per Revolution	2,000
Velocity filter time constant	10 samples
Run/stop threshold	1 count/sample
Stepper loop mode	Open (0)
Trajectory Parameters	
Axis Acceleration, Deceleration	6,210 counts/sample
Vector Acceleration, Deceleration	6,210 counts/sample
Following error	32,767
Target position	0
Axis Velocity	200 counts/sample
Vector Velocity	200 counts/sample
Operation mode	Absolute position (0)
Gear master	None (0)
Enable gearing	All disabled (0)
Gear ratio	0
Gear ratio type	Absolute (0)
Blend factor	Blend at decel (-1)

Table C-1. Default Parameters (Continued)

Parameter	Factory Default
Position modulus	None (0)
S-Curve time	1 sample
Torque limit positive (primary and secondary)	32,767 (+10 V)
Torque limit negative (primary and secondary)	-32,768 (-10 V)
Torque offset (primary and secondary)	0
Velocity threshold	524,288,000 counts/sample
Motion I/O Parameters	
Enable inhibits	All enabled (0x7E)
Inhibit polarity	Inverting (0x7E)
Enable home inputs	All disabled (0)
Enable forward limit inputs	All disabled (0)
Enable reverse limit inputs	All disabled (0)
Enable S/W limits	All disabled (0)
Axis n forward S/W limit position	$2^{30}-1$ counts/steps
Axis n reverse S/W limit position	-2^{30} counts/steps
Home polarity	Inverting (0x7E)
Inhibit mustOn	All on (0x7E)
Inhibit mustOff	0
Forward limit polarity	Inverting (0x7E)
Reverse limit polarity	Inverting (0x7E)
Breakpoint modulus	None (0)
Breakpoint position	0
Breakpoint mustOn	0
Breakpoint mustOff	All off (0x7E)

Table C-1. Default Parameters (Continued)

Parameter	Factory Default
Enable high-speed capture	All disabled (0)
High-speed capture polarity	Noninverting (0)
High-speed capture source	Trigger input on I/O connector
Analog & Digital I/O Parameters	
ADC enable	None (0)
ADC range	-10 to +10 V
Encoder enable	None (0)
Maximum encoder frequency (7344 only)	1.6 MHz
I/O port direction	1 and 2 input, 3 output (FlexMotion-6C); All input (7344)
I/O port mustOn	0
I/O port mustOff	All off (0xFF)
I/O port polarity	Inverting (0xFF)
RTSI port (7344 only)	All input, no RTSI lines driven
General purpose variables	All 0
Interrupt event mask	All events masked off (0)

Onboard Variables, Input, and Return Vectors

This appendix gives additional information on how to use input and return vectors in conjunction with onboard variables.

Table D-1 list functions with more than one data parameter that require multiple variables when using vectors. The Maximum Variable Number column lists the highest variable number that a vector can point to and still have room for all the data without exceeding the total variable space.

This appendix also highlights a few special cases where the number of parameters does not equal the number of variables. These cases are described in the notes that follow the table.

Table D-1. Functions with More than One Data Parameter

Function Name	Vector Type	Number of Parameters	Number of Variables Required	Maximum Variable Number
Load All PID Parameters	Input	8	8	0x71
Configure Velocity Filter	Input	2	2	0x77
Load Velocity in RPM	Input	1	4 (note 1)	0x75
Load Accel/Decel in RPS/sec	Input	1	4 (note 1)	0x75
Load Vector Space Position	Input	3	3	0x76
Read Velocity in RPM	Return	1	4 (note 1)	0x75
Read Vector Space Position	Return	3	3	0x76
Reset Position	Input	2	2	0x77
Load Circular Arc	Input	3	5 (notes 2 and 3)	0x74
Load Helical Arc	Input	4	4 (note 2)	0x75
Load Spherical Arc	Input	5	5 (note 2)	0x74
Load Gear Ratio	Input	3	3	0x76
Load Velocity Threshold in RPM	Input	1	4 (note 1)	0x75

Table D-1. Functions with More than One Data Parameter (Continued)

Function Name	Vector Type	Number of Parameters	Number of Variables Required	Maximum Variable Number
Load Torque Limit	Input	4	4	0x75
Load Torque Offset	Input	2	2	0x77
Read DAC Limit Status	Return	2	1 (note 4)	0x78
Read Trajectory Data	Return	2 (per axis)	2 (note 5)	note 5
Load Software Limit Positions	Input	2	2	0x77
Read Limit Status	Return	2	1 (note 4)	0x78
Wait on Condition	Return	2	2 (note 6)	0x77
<p>Notes</p> <p>¹ RPM and RPSPS are double precision floating point values (f64). They are internally represented in IEEE floating point format in four 16-bit words. This format is also used in the communications packet between the host computer and the FlexMotion controller.</p> <p>² While the three Arc functions take double-precision floating-point values (f64) for their angle parameters, these values are converted to 32 bit values (i32 and u32) in the FlexMotion DLL before being sent to the controller. Therefore, unlike other FlexMotion functions taking floating-point values, the internal representation for each angle parameter requires only one variable.</p> <p>³ The Load Circular Arc and Load Spherical Arc functions are implemented identically on the FlexMotion controller. The FlexMotion DLL simply substitutes zeros for plane pitch and yaw when you call the Load Circular Arc function. When using variables and vectors, use the Load Spherical Arc function exclusively.</p> <p>⁴ The Read Limit Status and Read DAC Limit Status functions return the forward and reverse status bytes (u8) packed together as one 16-bit word (u16). Only one variable is required.</p> <p>⁵ The Read Trajectory Data function returns two values (position and velocity) per axis. The total number of variable required is therefore two times the number of axes selected with the Acquire Trajectory Data function. Also, the maximum variable number is therefore 0x78 minus two times the number of axes selected with the Acquire Trajectory Data function.</p> <p>⁶ The Wait on Condition function can return two values, condition code and bitmapped status, to the variables specified with the return vector.</p>				

Technical Support Resources

This appendix describes the comprehensive resources available to you in the Technical Support section of the National Instruments Web site and provides technical support telephone numbers for you to use if you have trouble connecting to our Web site or if you do not have internet access.

NI Web Support

To provide you with immediate answers and solutions 24 hours a day, 365 days a year, National Instruments maintains extensive online technical support resources. They are available to you at no cost, are updated daily, and can be found in the Technical Support section of our Web site at www.natinst.com/support.

Online Problem-Solving and Diagnostic Resources

- **KnowledgeBase**—A searchable database containing thousands of frequently asked questions (FAQs) and their corresponding answers or solutions, including special sections devoted to our newest products. The database is updated daily in response to new customer experiences and feedback.
- **Troubleshooting Wizards**—Step-by-step guides lead you through common problems and answer questions about our entire product line. Wizards include screen shots that illustrate the steps being described and provide detailed information ranging from simple getting started instructions to advanced topics.
- **Product Manuals**—A comprehensive, searchable library of the latest editions of National Instruments hardware and software product manuals.
- **Hardware Reference Database**—A searchable database containing brief hardware descriptions, mechanical drawings, and helpful images of jumper settings and connector pinouts.
- **Application Notes**—A library with more than 100 short papers addressing specific topics such as creating and calling DLLs, developing your own instrument driver software, and porting applications between platforms and operating systems.

Software-Related Resources

- **Instrument Driver Network**—A library with hundreds of instrument drivers for control of standalone instruments via GPIB, VXI, or serial interfaces. You also can submit a request for a particular instrument driver if it does not already appear in the library.
- **Example Programs Database**—A database with numerous, non-shipping example programs for National Instruments programming environments. You can use them to complement the example programs that are already included with National Instruments products.
- **Software Library**—A library with updates and patches to application software, links to the latest versions of driver software for National Instruments hardware products, and utility routines.

Worldwide Support

National Instruments has offices located around the globe. Many branch offices maintain a Web site to provide information on local services. You can access these Web sites from www.natinst.com/worldwide.

If you have trouble connecting to our Web site, please contact your local National Instruments office or the source from which you purchased your National Instruments product(s) to obtain support.

For telephone support in the United States, dial 512 795 8248. For telephone support outside the United States, contact your local branch office:

Australia 03 9879 5166, Austria 0662 45 79 90 0, Belgium 02 757 00 20,
Brazil 011 284 5011, Canada (Calgary) 403 274 9391,
Canada (Ontario) 905 785 0085, Canada (Québec) 514 694 8521,
China 0755 3904939, Denmark 45 76 26 00, Finland 09 725 725 11,
France 01 48 14 24 24, Germany 089 741 31 30, Greece 30 1 42 96 427
Hong Kong 2645 3186, India 91805275406, Israel 03 6120092,
Italy 02 413091, Japan 03 5472 2970, Korea 02 596 7456,
Mexico (D.F.) 5 280 7625, Mexico (Monterrey) 8 357 7695,
Netherlands 0348 433466, Norway 32 27 73 00, Singapore 2265886,
Spain (Barcelona) 93 582 0251, Spain (Madrid) 91 640 0085,
Sweden 08 587 895 00, Switzerland 056 200 51 51,
Taiwan 02 2377 1200, United Kingdom 01635 523545

Glossary

Prefix	Meanings	Value
n-	nano-	10^{-9}
μ -	micro-	10^{-6}
m-	milli-	10^{-3}
c-	centi-	10^{-2}
k-	kilo-	10^3
M-	mega-	10^6

Numbers/Symbols

%	percent
\pm	plus or minus
+	positive of, or plus
-	negative of, or minus
/	per
$^{\circ}$	degree
Ω	ohm
%	percent

A

A	amperes
absolute mode	treat the target position loaded as position relative to zero (0) while making a move
absolute position	position relative to zero

acceleration	A measurement of the change in velocity as a function of time. Acceleration describes the period when velocity is changing from one value to another. From a stop (zero velocity) to a desired speed (<i>target</i> velocity) or vice versa.
active-high	a signal is active when its value goes high (1)
active-low	a signal is active when its value goes low (0)
A/D	analog-to-digital
address	character code that identifies a specific location (or series of locations) in memory
axis	the unit which is used to control a motor or any similar device
B	
b	bit—one binary digit, either 0 or 1
base address	A memory address that serves as the starting address for programmable registers. All other addresses are located by adding to the base address.
binary	a number system with a base of 2
buffer	temporary storage for acquired or generated data (software)
bus	The group of conductors that interconnect individual circuitry in a computer. Typically, a bus is the expansion vehicle to which I/O or other devices are connected. Examples of PC buses are the ISA and PCI bus.
byte	Eight related bits of data, an 8-bit binary number. Also used to denote the amount of memory required to store one byte of data.
C	
CCW	counter-clockwise—implies direction of rotation of the motor
closed-loop	A broadly applied term relating to any system where output is measured and compared to input. The output is then adjusted to reach the desired condition. In motion control this term applies to a system using an encoder or any feedback device.

commutation	The sequential control of switched waveforms from the power driver amplifier into the motor phase windings that will cause rotation or linear motion depending on motor type. Brush type motors <i>auto-commutate</i> due to the brush contact with the motor windings. Brushless type motors require the advance information of position and direction in order to accurately provide correct waveform switching sequences. Brushless motors typically use hall-effect type sensors to generate the commutation control waveforms.
control system bandwidth	This is the measure of a closed-loop system's response and is typically represented as a frequency range or an update period for the PID loop in a digital servo controller. For example, if a PID loop has an update rate of 250 μ s, it would have a bandwidth of 4 kHz.
CPU	central processing unit
CW	clockwise—implies direction of rotation of the motor
D	
DC	direct current
deceleration	A measurement of the change in velocity as a function of time. Deceleration describes the period when velocity is changing from one value to another. From a stop (zero velocity) to a desired speed (<i>target</i> velocity) or vice versa. Deceleration is also considered negative acceleration.
dedicated	assigned totally for a particular function
DGND	digital ground
digital I/O port	a group of digital input/output signals
DIP	dual inline package
DLL	Dynamic Link Library for Windows. Provides the API (Application programming interface) for the motion controllers.
drivers	software that controls a specific hardware device such as a DAQ board or a motion controller

E

- encoder a device that translates mechanical motion into electrical signals used for monitoring position or velocity
- encoder resolution The number of encoder lines between consecutive encoder indexes (marker or Z-bit). If the encoder does not have an index output, the encoder resolution can be referred to as lines per revolution.

F

- FIFO First-in-first-out memory buffer—the first data stored is the first data sent to the acceptor. FIFOs are often used on DAQ devices to temporarily store incoming or outgoing data until that data can be retrieved or output. For example, an analog input FIFO stores the results of A/D conversions until the data can be retrieved into system memory, a process that requires the servicing of interrupts and often the programming of the DMA controller. This process can take several milliseconds in some cases. During this time, data accumulates in the FIFO for future retrieval. With a larger FIFO, longer latencies can be tolerated. In the case of analog output, a FIFO permits faster update rates, because the waveform data can be stored on the FIFO ahead of time. This again reduces the effect of latencies associated with getting the data from system memory to the DAQ device.
- filter parameters indicates the control loop parameter gains (PID gains) for a given axis
- filtering a type of signal conditioning that allows you to filter unwanted signals from the signal you are trying to measure
- flash non-volatile memory used for storing code, programs, and data
- following error trip point Following error is the difference between the instantaneous commanded trajectory position and the feedback position. If the following error increases beyond the maximum allowable value entered (called the following error trip point), the motors trip out on following error (that is, are killed, thus preventing the axis from running away).
- freewheel the condition of a motor when power is de-energized and the motor shaft is free to turn with only frictional forces to impede it
- full-step full-step mode of a stepper motor—for a two phase motor this is done by energizing two windings or phases at a time

function declaration	a specification showing the return value and parameters for a function
function library	a collection of related functions packaged into a dynamic link library (DLL) for Windows, or a library file for DOS

G

Gnd	ground
GND	ground

H

half-step	Half-step mode of a stepper motor—for a two phase motor this is done by alternately energizing two windings and then only one. In half-step mode, alternate steps are strong and weak but there is significant improvement in low-speed smoothness over the full-step mode.
hex	hexadecimal
holding torque	The force that a motor can provide or withstand while still remaining in a fixed stop location without any rotation, translation or movement.
home switch/home position (input)	A reference position in a motion control system derived from a mechanical datum or switch. Often designated as the <i>zero</i> position. The motion controller halts the motor if it finds this switch active while doing a find home sequence.
host computer	computer into which the motion controller is plugged
hybrid stepper motor	A motor type designed to move in discrete step increments, (typically specified in degrees). Hybrid stepper motors have permanent magnet rotor elements with a coil wound stator (outer shell) and no brushes contacting between the two. The current through the coil phases is switched in a predetermined sequence (commutated) to produce desired motion in a given direction.
Hz	hertz—the number of scans read or updates written per second

I

I/O	input/output—the transfer of data to/from a computer system involving communications channels, operator interface devices, and/or data acquisition and control interfaces
ID	identifier
import library	A Windows-specific file that contains information about the functions contained in a companion dynamic link library (DLL). Windows applications are typically linked to one or more import libraries.
in	inches
index	marker between consecutive encoder revolutions
inverting	Defines the polarity of a switch (limit switch, home switch, and so on) when it is in its <i>active</i> state. If these inputs are active-low they are said to have inverting polarity.
IRQ	interrupt request
ISA	industry-standard architecture

J

jerk	the derivative of acceleration (change of acceleration per unit time) measured in units of counts (steps)/s ³
------	--

K

k	kilo—the standard metric prefix for 1,000, or 10 ³ , used with units of measure such as volts, hertz, and meters
K	kilo—the prefix for 1,024, or 2 ¹⁰ , used with byte in quantifying data or computer memory

L

latching	a signal that maintains its value while in a given state, as opposed to a signal that momentarily pulses when entering or exiting a state
LIFO	last-in-first-out
limit switch/ end-of-travel (input)	properly designed motion control systems have sensors called limit switches that alert the control electronics that physical end of travel is being approached and that the motion should stop
loop tuning bode plot	A graphical display of the measured or calculated system gain and phase margin versus frequency of a closed-loop system for a given range of input frequency. The Tune PID bode plot VI function provides an interactive display of the steady state performance of the closed-loop control system, taking into account actual system characteristics.

M

m	meters
MCS	Move Complete Status
microstep	Microstepping mode of a stepper motor—subdividing the basic motor step by proportioning the current in the windings. In this way the step size is reduced and low speed smoothness is dramatically improved.
modulo position	treat the position as within the range of total quadrature counts per revolution for an axis
MustOff	state or bit that is forced off (False) or must be off to satisfy a condition
MustOn	state or bit that is forced on (True) or must be on to satisfy a condition

N

noise	An undesirable electrical signal—Noise comes from external sources such as the AC power line, motors, generators, transformers, fluorescent lights, soldering irons, CRT displays, computers, electrical storms, welders, radio transmitters, and internal sources such as semiconductors, resistors, and capacitors. Noise corrupts signals you are trying to send or receive.
-------	---

noninverting Defines the polarity of a switch (limit switch, home switch, and so on) when it is in its *active* state. If these inputs are active-high low they are said to have noninverting polarity.

O

OL open-loop—refers to a motion control system where no external sensors (feedback devices) are used to provide position or velocity correction signals

P

packets command and data sent as a group over a computer bus

phase angle/
phase margin A value presented in PID Loop Tuning Bode Plot analysis that represents the advance or lead of an input signal to the output signal in a closed-loop servo controller. Used to determine closed-loop system stability at a given crossover frequency.

PID proportional integral derivative control loop

PID loop tuning/
servo compensation Flexible adjustment of the Proportional, Integral, and Derivative Gain Parameters along with loop update rate or frequency to assure stable operation and desired dynamic response of a closed-loop servo system.

port (1) a communications connection on a computer or a remote controller
(2) a digital port, consisting of four or eight lines of digital input and/or output

position breakpoint Position breakpoint for an encoder can be set in absolute or relative quadrature counts. When the encoder reaches a position breakpoint, the associated high-speed breakpoint output immediately transitions.

position resolution Typically determined by the smallest increment of motion that can be controlled. In Stepper Motor systems, it is determined by the number of steps per revolution, typically as a limitation of the stepper driver microstepping value or of the feedback device resolution. In Servo Motor systems, it is entirely determined by the resolution of the feedback device in counts per revolution of the motor.

power cycling Implies turning the host computer off and then back on. This resets the motion controller.

profile	instantaneous position versus time output of a trajectory generator
pull-in move	When stepper motors are run in closed-loop mode, the encoder feedback is used to verify the position of an axis when the motion ends. The motion controller then commands the axis to do a final move so that it is at the desired target position.
PWM	Pulse Width Modulation—a method of controlling the average current in a motors phase windings by varying the on-time (duty cycle) of transistor switches

Q

quadrature counts	The encoder line resolution times four. The encoder resolution is the number of encoder lines between consecutive encoder indexes (marker or Z-bit). If the encoder does not have an index output the encoder resolution can be referred to as lines per revolution, lines per inch, lines per millimeter, and so on.
-------------------	---

R

RAM	random-access memory
relative breakpoint	sets the position breakpoint for an encoder in relative quadrature counts
relative mode	treat the target position loaded as position relative to current position while making a move
relative position	position relative to current position
ribbon cable	a flat cable in which the conductors are side by side
ROM	read-only memory—non-volatile memory used for storing code, programs, and data
rotary axis	An axis for which rotary counts are loaded. The axis moves to the target position by taking the shortest path, either forward or backwards, while remaining within the one revolution defined by the loaded modulo value.
RPM	revolutions per minute. Units for velocity.
RPPS or RPS/s	revolutions per second square. Units for acceleration and deceleration.

RTSI	Real-Time System Integration bus—the National Instruments timing bus that connects controllers directly, by means of connectors on top of the controllers, for precise synchronization of functions.
S	
s	seconds
sec	seconds
servo	(1) specifies an axis that controls a servo motor (2) specifies when a servo motor becomes active
slot	a position where a module can be inserted into an ISA or PCI backplane
step output rate	The frequency of the step output control pulses generated by a controller/indexer and provided to an amplifier driver. The combination of step output rate (steps/s), steps per revolution (steps/rev), and time (60 s/minute) provide a basic representation of motor velocity in RPM. Linear speed may be further derived by additional mechanical data, lead screw revolutions per inch, and so on.
stepper	specifies an axis that controls a stepper motor.
T	
toggle	changing state from high to low, back to high and so on
torque	force tending to produce rotation
trapezoidal profile	A typical motion trajectory, where a motor accelerates up to the programmed velocity using the programmed acceleration, traverses at the programmed velocity and then decelerates at the programmed acceleration to the target position.
trigger	any event that causes or starts some form of data capture
trigger buffer inputs	A digital signal that begins the execution of a sequence of motion commands stored on the controller/indexer allowing the commands to fully execute until the end of the sequence is reached.
TTL	transistor-transistor logic

U

UOM unit of measure

V

V volts

velocity mode move the axis continuously at the specified velocity

W

watchdog a timer task that shuts down (resets) the motion controller if any serious error occurs

word The standard number of bits that a processor or memory manipulates at one time. Microprocessors typically use 8-, 16-, or 32-bit words.

Z

Z-bit marker or index between consecutive encoder revolutions

Index

A

acceleration feedforward gain, changing, 5-26

acceleration in RPS/s, 4-19

ADC channels

 purpose and use, 4-5 to 4-6

 resource IDs (table), 4-6

ADC functions

 flex_enable_adcs, 10-7 to 10-8

 flex_read_adc function, 10-13 to 10-14

 flex_read_adc_rtn function, 10-13 to 10-14

 flex_set_adc_range, 10-23 to 10-24

advanced functions, 13-1 to 13-18

 flex_clear_pu_status, 13-2 to 13-3

 flex_communicate, 13-4 to 13-6

 flex_enable_1394_watchdog, 13-7

 flex_enable_auto_start, 13-8

 flex_enable_shutdown, 13-9 to 13-10

 flex_flush_rdb, 13-11

 flex_read_csr_rtn, 13-12 to 13-13

 flex_reset_defaults, 13-14

 flex_save_defaults, 13-15

 flex_set_irq_mask, 13-16 to 13-18

 summary (table), B-7

advanced trajectory functions, 6-72 to 6-102

 flex_acquire_trajectory_data, 6-73 to 6-74

 flex_load_base_vel, 6-75

 flex_load_blend_fact, 6-76 to 6-78

 flex_load_pos_modulus, 6-79

 flex_load_rpm_thresh, 6-80 to 6-81

 flex_load_scurve_time, 6-82 to 6-83

 flex_load_torque_lim, 6-84 to 6-86

 flex_load_torque_offset, 6-87 to 6-88

 flex_load_vel_override, 6-91 to 6-92

 flex_load_vel_threshold, 6-89 to 6-90

 flex_read_dac, 6-93 to 6-94

 flex_read_dac_limit_status, 6-95 to 6-96

 flex_read_dac_limit_status_rtn,
 6-95 to 6-96

 flex_read_dac_rtn, 6-93 to 6-94

 flex_read_steps_gen, 6-97 to 6-98

 flex_read_steps_gen_rtn, 6-97 to 6-98

 flex_read_target_pos, 6-99 to 6-100

 flex_read_target_pos_rtn, 6-99 to 6-100

 flex_read_trajectory_data, 6-101 to 6-102

 flex_read_trajectory_data_rtn,
 6-101 to 6-102

 summary (table), B-3

analog & digital I/O functions, 10-1 to 10-31

 default parameters (table), C-4

 flex_configure_encoder_filter, 10-2 to 10-3

 flex_configure_pwm_output, 10-4 to 10-6

 flex_enable_adcs, 10-7 to 10-8

 flex_enable_encoders, 10-9 to 10-10

 flex_load_dac, 10-11

 flex_load_pwm_duty, 10-12

 flex_read_adc, 10-13 to 10-14

 flex_read_adc_rtn, 10-13 to 10-14

 flex_read_encoder, 10-15 to 10-16

 flex_read_encoder_rtn, 10-15 to 10-16

 flex_read_port, 10-17 to 10-18

 flex_read_port_rtn, 10-17 to 10-18

 flex_reset_encoder, 10-19

 flex_select_signal, 10-20 to 10-22

 flex_set_adc_range, 10-23 to 10-24

 flex_set_port_direction, 10-25 to 10-26

 flex_set_port_momo, 10-27 to 10-29

 flex_set_port_pol, 10-30 to 10-31

 summary (table), B-5

API functional organization, 4-1 to 4-2

application development. *See* FlexMotion

 Windows libraries; programming language considerations.

arc angles in degrees, 4-19 to 4-20

arcs functions, 6-55 to 6-62
 flex_load_circular_arc, 6-56 to 6-57
 flex_load_helical_arc, 6-58 to 6-59
 flex_load_spherical_arc, 6-60 to 6-62
 summary (table), B-3

array data type, 3-2

automatic startup function
 (flex_enable_auto_start), 13-8

axes, 4-2 to 4-4
 configuring, 4-2
 definition, 4-2
 resource IDs (table), 4-4
 stepper axis resources (figure), 4-3

axis & resource configuration functions,
 5-1 to 5-31
 default parameters (table), C-1 to C-2
 flex_config_axis, 5-2 to 5-5
 flex_config_mc_criteria, 5-6 to 5-8
 flex_config_step_mode_pol, 5-9 to 5-10
 flex_config_vect_spc, 5-11 to 5-12
 flex_enable_axes, 5-13 to 5-16
 flex_load_counts_steps_rev, 5-17 to 5-18
 flex_load_pid_parameters, 5-19 to 5-20
 flex_load_single_pid_parameter,
 5-21 to 5-27
 flex_load_vel_tc_rs, 5-28 to 5-29
 flex_set_stepper_loop_mode,
 5-30 to 5-31
 summary (table), B-1

B

bitmapped versus per-resource functions, 4-10

blend functions. *See also* move functions.
 flex_blend, 7-2 to 7-4
 flex_check_blend_complete_status,
 6-2 to 6-3
 flex_load_blend_fact, 6-76 to 6-78
 flex_read_blend_status, 6-24 to 6-26
 flex_read_blend_status_rtn, 6-24 to 6-26

flex_wait_for_blend_complete,
 6-49 to 6-51

board ID, in host-FlexMotion board
 communication, 4-20

board identification parameter, 3-4

Borland C/C++ application, creating,
 2-2 to 2-3. *See also* C/C++ applications.

breakpoint functions, 8-21 to 8-32
 flex_enable_bp, 8-22 to 8-24
 flex_load_bp_modulus, 8-25 to 8-26
 flex_load_pos_bp, 8-27 to 8-28
 flex_read_breakpoint_status,
 8-29 to 8-30
 flex_read_breakpoint_status_rtn,
 8-29 to 8-30
 flex_set_bp_momo, 8-31 to 8-32
 summary (table), B-4

BridgeVIEW software, 1-2

building applications. *See* FlexMotion
 windows libraries; programming language
 considerations.

C

capture functions. *See* high-speed capture
 functions.

C/C++ applications
 creating 32-bit Windows applications,
 2-2 to 2-3
 programming considerations, 3-4 to 3-6
 data returned by reference, 3-4 to 3-5
 data returned in arrays, 3-5
 FlexMotion data structures,
 3-5 to 3-6

communication with host computer,
 4-20 to 4-22
 board ID, 4-20
 packets, handshaking, and FIFO
 buffers, 4-21
 return data buffer, 4-21 to 4-22

- configuration functions
 - advanced functions
 - flex_set_irq_mask, 13-16 to 13-18
 - analog & digital I/O functions
 - flex_configure_encoder_filter, 10-2 to 10-3
 - flex_configure_pwm_output, 10-4 to 10-6
 - flex_set_adc_range, 10-23 to 10-24
 - flex_set_port_direction, 10-25 to 10-26
 - flex_set_port_momo, 10-27 to 10-29
 - flex_set_port_pol, 10-30 to 10-31
 - axis & resource configuration functions
 - flex_config_axis, 5-2 to 5-5
 - flex_config_mc_criteria, 5-6 to 5-8
 - flex_config_step_mode_pol, 5-9 to 5-10
 - flex_config_vect_spc, 5-11 to 5-12
 - flex_set_stepper_loop_mode, 5-30 to 5-31
 - breakpoint functions
 - flex_set_bp_momo, 8-31 to 8-32
 - gearing functions
 - flex_config_gear_master, 6-64 to 6-65
 - high-speed capture functions
 - flex_set_hs_cap_pol, 8-41 to 8-42
 - motion I/O functions
 - flex_configure_inhibits, 8-2 to 8-3
 - flex_set_home_polarity, 8-15 to 8-16
 - flex_set_inhibit_momo, 8-17 to 8-18
 - flex_set_limit_polarity, 8-19 to 8-20
 - onboard programming functions
 - flex_set_status_momo, 12-16 to 12-17
 - trajectory control functions
 - flex_set_op_mode, 6-45 to 6-48

D

- DAC functions
 - flex_load_dac, 10-11
 - flex_read_dac, 6-93 to 6-94
 - flex_read_dac_limit_status, 6-95 to 6-96
 - flex_read_dac_limit_status_rtn, 6-95 to 6-96
 - flex_read_dac_rtn, 6-93 to 6-94
- DAC outputs
 - purpose and use, 4-6 to 4-7
 - resource IDs (table), 4-7
 - resources (figure), 4-6
- data operations functions, 12-31 to 12-44
 - flex_add_vars, 12-32
 - flex_and_vars, 12-33
 - flex_div_vars, 12-34
 - flex_load_var, 12-35
 - flex_lshift_var, 12-36 to 12-37
 - flex_mult_vars, 12-38
 - flex_not_var, 12-39
 - flex_or_vars, 12-40
 - flex_read_var, 12-41 to 12-42
 - flex_read_var_rtn, 12-41 to 12-42
 - flex_sub_vars, 12-43
 - flex_xor_vars, 12-44
 - summary (table), B-6 to B-7
- data returned by reference
 - C/C++ for Windows, 3-4 to 3-5
 - Visual Basic for Windows, 3-7
- data returned in arrays
 - C/C++ for Windows, 3-5
 - Visual Basic for Windows, 3-7 to 3-8
- data structures, 3-3, 3-5 to 3-6
- data types, 3-1 to 3-3
 - arrays, 3-2
 - primary types (table), 3-2
 - structures and other user-defined data types, 3-3

default management functions
 flex_reset_defaults, 13-14
 flex_save_defaults, 13-15

default parameters (table), C-1 to C-4
 analog & digital I/O parameters, C-4
 axis & resource configuration parameters,
 C-1 to C-2
 motion I/O parameters, C-3 to C-4
 trajectory parameters, C-2 to C-3

derivative gain, changing, 5-24

derivative sample period, changing,
 5-24 to 5-25

developing applications. *See* FlexMotion
 Windows libraries; programming language
 considerations.

diagnostic resources, online, E-1

digital I/O functions. *See* analog & digital I/O
 functions.

documentation
 conventions used in manual, xv
 related documentation, xvi

double-buffered parameters, 4-10 to 4-11

E

electronic gearing, 4-16. *See also* gearing
 functions.

enabling functions
 flex_enable_1394_watchdog, 13-7
 flex_enable_adcs function, 10-7 to 10-8
 flex_enable_auto_start, 13-8
 flex_enable_axes function, 5-13 to 5-16
 flex_enable_bp function, 8-22 to 8-24
 flex_enable_encoders function,
 10-9 to 10-10
 flex_enable_gearing function,
 6-66 to 6-67
 flex_enable_gearing_single_axis,
 6-68 to 6-69
 flex_enable_home_inputs function,
 8-4 to 8-5

 flex_enable_hs_caps function,
 8-34 to 8-35
 flex_enable_limits function, 8-6 to 8-8
 flex_enable_shutdown, 13-9 to 13-10

encoder functions
 flex_configure_encoder_filter,
 10-2 to 10-3
 flex_enable_encoders, 10-9 to 10-10
 flex_read_encoder, 10-15 to 10-16
 flex_read_encoder_rtn, 10-15 to 10-16
 flex_reset_encoder, 10-19

encoders
 encoder resource IDs (table), 4-5
 purpose and use, 4-4 to 4-5

error & utility functions, 11-1 to 11-12
 flex_get_error_description, 11-2 to 11-5
 flex_get_motion_board_info,
 11-6 to 11-8
 flex_get_motion_board_name,
 11-9 to 11-10
 flex_read_err_msg_rtn, 11-11 to 11-12
 summary (table), B-5

errors and error handling, 4-22 to 4-25
 error codes summary (table), A-1 to A-13
 error handling techniques, 4-24 to 4-25
 fatal hardware and communication
 errors, 4-24
 modal and non-modal errors, 4-22 to 4-24
 communication versus individual
 function entry points, 4-23
 error message stack, 4-23
 onboard programs, 4-24

F

fatal hardware and communication
 errors, 4-24

FIFO buffers, in host-FlexMotion board
 communication, 4-21

- Find Home & Find Index functions, 9-1 to 9-8
 - flex_find_home, 9-2 to 9-6
 - flex_find_index, 9-7 to 9-8
 - summary (table), B-5
- flex_acquire_trajectory_data function, 6-73 to 6-74
- flex_add_vars function, 12-32
- flex_and_vars function, 12-33
- flex_begin_store function, 12-2 to 12-3
- flex_blend function, 7-2 to 7-4
- flex_check_blend_complete_status function, 6-2 to 6-3
- flex_check_move_complete_status function, 6-4 to 6-5
- flex_clear_pu_status function, 13-2 to 13-3
- flex_communicate function, 13-4 to 13-6
- flex_config_axis function, 5-2 to 5-5
- flex_config_gear_master function, 6-64 to 6-65
- flex_config_mc_criteria function, 5-6 to 5-8
- flex_config_step_mode_pol function, 5-9 to 5-10
- flex_config_vect_spc function, 5-11 to 5-12
- flex_configure_inhibits function, 8-2 to 8-3
- flex_configure_encoder_filter, 10-2 to 10-3
- flex_configure_pwm_output function, 10-4 to 10-6
- flex_div_vars function, 12-34
- flex_enable_1394_watchdog function, 13-7
- flex_enable_adcs function, 10-7 to 10-8
- flex_enable_auto_start function, 13-8
- flex_enable_axes function, 5-13 to 5-16
- flex_enable_bp function, 8-22 to 8-24
- flex_enable_encoders function, 10-9 to 10-10
- flex_enable_gearing function, 6-66 to 6-67
- flex_enable_gearing_single_axis, 6-68 to 6-69
- flex_enable_home_inputs function, 8-4 to 8-5
- flex_enable_hs_caps function, 8-34 to 8-35
- flex_enable_limits function, 8-6 to 8-8
- flex_enable_shutdown function, 13-9 to 13-10
- flex_end_store function, 12-4
- flex_find_home function, 9-2 to 9-6
- flex_find_index function, 9-7 to 9-8
- flex_flush_rdb function, 13-11
- flex_get_error_description function, 11-2 to 11-5
- flex_get_motion_board_info function, 11-6 to 11-8
- flex_get_motion_board_name function, 11-9 to 11-10
- flex_insert_program_label function, 12-5
- flex_jump_label_on_condition function, 12-6 to 12-10
- flex_load_acceleration function, 6-6 to 6-7
- flex_load_base_vel function, 6-75
- flex_load_blend_fact function, 6-76 to 6-78
- flex_load_bp_modulus function, 8-25 to 8-26
- flex_load_circular_arc function, 6-56 to 6-57
- flex_load_counts_steps_rev function, 5-17 to 5-18
- flex_load_dac function, 10-11
- flex_load_delay function, 12-11
- flex_load_follow_err function, 6-8 to 6-9
- flex_load_gear_ratio function, 6-70 to 6-71
- flex_load_helical_arc function, 6-58 to 6-59
- flex_load_pid_parameters function, 5-19 to 5-20
- flex_load_pos_bp function, 8-27 to 8-28
- flex_load_pos_modulus function, 6-79
- flex_load_pwm_duty function, 10-12
- flex_load_rpm function, 6-10 to 6-11
- flex_load_rpm_thresh function, 6-80 to 6-81
- flex_load_rpsps function, 6-12 to 6-13
- flex_load_scurve_time function, 6-82 to 6-83
- flex_load_single_pid_parameter function, 5-21 to 5-27
 - acceleration feedforward gain, 5-26
 - derivative gain, 5-24
 - derivative sample period, 5-24 to 5-25
 - example, 5-27
 - integral gain, 5-23

- integration limit, 5-23
- parameters and parameter discussion, 5-21 to 5-22
- proportional gain, 5-22
- velocity feedback gain, 5-25 to 5-26
- velocity feedforward gain, 5-26 to 5-27
- flex_load_spherical_arc function, 6-60 to 6-62
- flex_load_sw_lim_pos function, 8-9 to 8-10
- flex_load_target_pos function, 6-14 to 6-15
- flex_load_torque_lim function, 6-84 to 6-86
- flex_load_torque_offset function, 6-87 to 6-88
- flex_load_var function, 12-35
- flex_load_velocity function, 6-16 to 6-17
- flex_load_vel_override function, 6-91 to 6-92
- flex_load_vel_tc_rs function, 5-28 to 5-29
- flex_load_vel_threshold function, 6-89 to 6-90
- flex_load_vs_pos function, 6-18 to 6-19
- flex_lshift_var function, 12-36 to 12-37
- flex_mult_vars function, 12-38
- flex_not_var function, 12-39
- flex_or_vars function, 12-40
- flex_pause_prog function, 12-12
- flex_read_adc function, 10-13 to 10-14
- flex_read_adc_rtn function, 10-13 to 10-14
- flex_read_axis_status function, 6-20 to 6-23
- flex_read_axis_status_rtn function, 6-20 to 6-23
- flex_read_blend_status function, 6-24 to 6-26
- flex_read_blend_status_rtn function, 6-24 to 6-26
- flex_read_breakpoint_status function, 8-29 to 8-30
- flex_read_breakpoint_status_rtn function, 8-29 to 8-30
- flex_read_cap_pos function, 8-36 to 8-37
- flex_read_cap_pos_rtn function, 8-36 to 8-37
- flex_read_csr_rtn function, 13-12 to 13-13
- flex_read_dac function, 6-93 to 6-94
- flex_read_dac_limit_status function, 6-95 to 6-96
- flex_read_dac_limit_status_rtn function, 6-95 to 6-96
- flex_read_dac_rtn function, 6-93 to 6-94
- flex_read_encoder function, 10-15 to 10-16
- flex_read_encoder_rtn function, 10-15 to 10-16
- flex_read_err_msg_rtn function, 11-11 to 11-12
- flex_read_follow_err function, 6-27 to 6-28
- flex_read_follow_err_rtn function, 6-27 to 6-28
- flex_read_home_input_status function, 8-11 to 8-12
- flex_read_home_input_status_rtn function, 8-11 to 8-12
- flex_read_hs_cap_status function, 8-38 to 8-40
- flex_read_hs_cap_status_rtn function, 8-38 to 8-40
- flex_read_limit_status function, 8-13 to 8-14
- flex_read_limit_status_rtn function, 8-13 to 8-14
- flex_read_mcs_rtn function, 6-29 to 6-30
- flex_read_port function, 10-17 to 10-18
- flex_read_port_rtn function, 10-17 to 10-18
- flex_read_pos function, 6-31 to 6-32
- flex_read_pos_rtn function, 6-31 to 6-32
- flex_read_program_status function, 12-13 to 12-14
- flex_read_rpm function, 6-33 to 6-34
- flex_read_rpm_rtn function, 6-33 to 6-34
- flex_read_steps_gen function, 6-97 to 6-98
- flex_read_steps_gen_rtn function, 6-97 to 6-98
- flex_read_target_pos function, 6-99 to 6-100
- flex_read_target_pos_rtn function, 6-99 to 6-100
- flex_read_trajectory_data function, 6-101 to 6-102

- flex_read_trajectory_data_rtn function, 6-101 to 6-102
- flex_read_trajectory_status function, 6-35 to 6-38
- flex_read_trajectory_status_rtn function, 6-35 to 6-38
- flex_read_var function, 12-41 to 12-42
- flex_read_var_rtn function, 12-41 to 12-42
- flex_read_velocity function, 6-39 to 6-40
- flex_read_velocity_rtn function, 6-39 to 6-40
- flex_read_vs_pos function, 6-41 to 6-42
- flex_read_vs_pos_rtn function, 6-41 to 6-42
- flex_reset_defaults function, 13-14
- flex_reset_encoder function, 10-19
- flex_reset_pos function, 6-43 to 6-44
- flex_run_prog function, 12-15
- flex_save_defaults function, 13-15
- flex_select_signal function, 10-20 to 10-22
- flex_set_adc_range, 10-23 to 10-24
- flex_set_bp_momo function, 8-31 to 8-32
- flex_set_home_polarity function, 8-15 to 8-16
- flex_set_hs_cap_pol function, 8-41 to 8-42
- flex_set_inhibit_momo function, 8-17 to 8-18
- flex_set_irq_mask function, 13-16 to 13-18
- flex_set_limit_polarity function, 8-19 to 8-20
- flex_set_op_mode function, 6-45 to 6-48
 - example, 6-48
 - NIMC_ABSOLUTE_POSITION, 6-46
 - NIMC_MODULUS_POSITION, 6-48
 - NIMC_RELATIVE_POSITION, 6-46 to 6-47
 - NIMC_RELATIVE_TO_CAPTURE, 6-47
 - NIMC_VELOCITY, 6-47
 - parameters and parameter discussion, 6-45
- flex_set_port_direction function, 10-25 to 10-26
- flex_set_port_momo function, 10-27 to 10-29
- flex_set_port_pol function, 10-30 to 10-31
- flex_set_status_momo function, 12-16 to 12-17
- flex_set_stepper_loop_mode function, 5-30 to 5-31
- flex_start function, 7-5 to 7-7
- flex_stop_motion function, 7-8 to 7-11
- flex_stop_prog function, 12-18
- flex_sub_vars function, 12-43
- flex_wait_for_blend_complete function, 6-49 to 6-51
- flex_wait_for_move_complete function, 6-52 to 6-54
- flex_wait_on_condition function, 12-19 to 12-23
- flex_xor_vars function, 12-44
- FlexCommander application, 1-1
- FlexMotion controller, installing, 1-2
- FlexMotion data structures, 3-5 to 3-6
- FlexMotion software
 - API functional organization, 4-1 to 4-2
 - axes, 4-2 to 4-4
 - communication with host computer, 4-20 to 4-22
 - board ID, 4-20
 - packets, handshaking, and FIFO buffers, 4-21
 - return data buffer, 4-21 to 4-22
 - errors and error handling, 4-22 to 4-25
 - error handling techniques, 4-24 to 4-25
 - fatal hardware and communication errors, 4-24
 - modal and non-modal errors, 4-22 to 4-24
 - function types and parameters, 4-10 to 4-12
 - bitmapped versus per-resource functions, 4-10
 - input and return vectors, 4-11

- onboard variables, 4-12
 - single and double-buffered parameters, 4-10 to 4-11
- general-purpose I/O ports, 4-8
- initialization overview, 4-12 to 4-14
- installing FlexMotion controller, 1-2
- language support, 1-3
- motion resources, 4-4 to 4-7
 - ADC channels, 4-5 to 4-6
 - DAC outputs, 4-6 to 4-7
 - encoders, 4-4 to 4-5
 - stepper outputs, 4-7
- motion trajectories, 4-14 to 4-20
 - trajectory parameters, 4-17 to 4-20
 - trajectory types and modes, 4-14 to 4-17
- overview, 1-1
- requirements for getting started, 1-2
- resource IDs, 4-2
- software programming choices, 1-2
- vector spaces, 4-8 to 4-10
- Windows libraries, 2-1
- FlexMotion Windows libraries, 2-1 to 2-3
 - creating 32-bit Windows applications, 2-2 to 2-3
 - LabWindows/CVI application, 2-2
 - Microsoft or Borland C/C++ application, 2-2 to 2-3
 - Visual Basic application, 2-3
- overview, 2-1
- function return status, 3-3
- function types and parameters, 4-10 to 4-12
 - bitmapped versus per-resource functions, 4-10
- input and return vectors, 4-11
- onboard variables, 4-12
- single and double-buffered parameters, 4-10 to 4-11

- functions
 - advanced functions, 13-1 to 13-18
 - analog & digital I/O functions, 10-1 to 10-31
 - API functional organization, 4-1 to 4-2
 - axis & resource configuration functions, 5-1 to 5-31
 - default parameters (table), C-1 to C-4
 - analog & digital I/O parameters, C-4
 - axis & resource configuration parameters, C-1 to C-2
 - motion I/O parameters, C-3 to C-4
 - trajectory parameters, C-2 to C-3
 - error & utility functions, 11-1 to 11-12
 - Find Home & Find Index functions, 9-1 to 9-8
 - functions with more than one data parameter (table), D-1 to D-2
 - motion I/O functions, 8-1 to 8-42
 - onboard programming functions, 12-1 to 12-44
 - return status, 3-3
 - start & stop motion functions, 7-1 to 7-11
 - summary (table), B-1 to B-7
 - trajectory control functions, 6-1 to 6-102
 - ValueMotion to FlexMotion function cross-reference (table), B-7 to B-10

G

- gearing, electronic, 4-16
- gearing functions, 6-63 to 6-71
 - flex_config_gear_master, 6-64 to 6-65
 - flex_enable_gearing, 6-66 to 6-67
 - flex_enable_gearing_single_axis, 6-68 to 6-69
 - flex_load_gear_ratio, 6-70 to 6-71
 - summary (table), B-3
- general-purpose I/O ports
 - purpose and use, 4-8
 - resource IDs (table), 4-8

H

- handshaking, in host-FlexMotion board communication, 4-21
- high-speed capture functions, 8-33 to 8-42
 - flex_enable_hs_caps, 8-34 to 8-35
 - flex_read_cap_pos, 8-36 to 8-37
 - flex_read_cap_pos_rtn, 8-36 to 8-37
 - flex_read_hs_cap_status, 8-38 to 8-40
 - flex_read_hs_cap_status_rtn, 8-38 to 8-40
 - flex_set_hs_cap_pol, 8-41 to 8-42
 - summary (table), B-4 to B-5

I

- initialization, 4-12 to 4-14
 - overview, 4-12
 - recommended procedure, 4-13 to 4-14
 - establishing position reference (per-axis), 4-13
 - motion I/O configuration, 4-13
 - per-axis configuration, 4-13
 - system configuration, 4-13
 - trajectory parameter initialization (per-axis), 4-13
- input and return vectors
 - functions with more than one data parameter (table), D-1 to D-2
 - programming considerations, 3-10
 - purpose and use, 4-11
- installing FlexMotion controller, 1-2
- integral gain, changing, 5-23
- integration limit, changing, 5-23

L

- LabVIEW software, 1-2
- LabWindows/CVI software
 - creating 32-bit Windows applications, 2-2
 - overview, 1-2
- linear and circular interpolation, 4-16

load functions

- advanced trajectory functions
 - flex_load_base_vel, 6-75
 - flex_load_blend_fact, 6-76 to 6-78
 - flex_load_pos_modulus, 6-79
 - flex_load_rpm_thresh, 6-80 to 6-81
 - flex_load_scurve_time, 6-82 to 6-83
 - flex_load_torque_lim, 6-84 to 6-86
 - flex_load_torque_offset, 6-87 to 6-88
 - flex_load_vel_override, 6-91 to 6-92
 - flex_load_vel_threshold, 6-89 to 6-90
- analog & digital I/O functions
 - flex_load_dac, 10-11
 - flex_load_pwm_duty, 10-12
- arcs functions
 - flex_load_circular_arc, 6-56 to 6-57
 - flex_load_helical_arc, 6-58 to 6-59
 - flex_load_spherical_arc, 6-60 to 6-62
- axis & resource configuration functions
 - flex_load_counts_steps_rev, 5-17 to 5-18
 - flex_load_pid_parameters, 5-19 to 5-20
 - flex_load_single_pid_parameter, 5-21 to 5-27
 - flex_load_vel_tc_rs, 5-28 to 5-29
- breakpoint functions
 - flex_load_bp_modulus, 8-25 to 8-26
 - flex_load_pos_bp, 8-27 to 8-28
- data operations functions
 - flex_load_var, 12-35
- gearing functions
 - flex_load_gear_ratio, 6-70 to 6-71
- motion I/O functions
 - flex_load_sw_lim_pos, 8-9 to 8-10
- object management functions
 - flex_load_description, 12-25

- onboard programming functions
 - flex_load_delay, 12-11
- trajectory control functions
 - flex_load_acceleration, 6-6 to 6-7
 - flex_load_follow_err, 6-8 to 6-9
 - flex_load_rpm, 6-10 to 6-11
 - flex_load_rpsps, 6-12 to 6-13
 - flex_load_target_pos, 6-14 to 6-15
 - flex_load_velocity, 6-16 to 6-17
 - flex_load_vs_pos, 6-18 to 6-19

M

- manual. *See* documentation.
- Measurement & Automation Explorer, 1-1
- Microsoft C/C++ application, creating, 2-2 to 2-3. *See also* C/C++ applications.
- modal and non-modal errors, 4-22 to 4-24
 - communication versus individual function entry points, 4-23
 - error message stack, 4-23
 - onboard programs, 4-24
- MOMO protocol functions. *See* MustOn/MustOff (MOMO) protocol functions.
- motion boards
 - flex_get_motion_board_info function, 11-6 to 11-8
 - flex_get_motion_board_name function, 11-9 to 11-10
 - installing FlexMotion controller, 1-2
- motion I/O configuration, in initialization, 4-13
- motion I/O functions, 8-1 to 8-42
 - breakpoint functions, 8-21 to 8-32
 - flex_enable_bp, 8-22 to 8-24
 - flex_load_bp_modulus, 8-25 to 8-26
 - flex_load_pos_bp, 8-27 to 8-28
 - flex_read_breakpoint_status, 8-29 to 8-30
 - flex_read_breakpoint_status_rtn, 8-29 to 8-30
 - flex_set_bp_momo, 8-31 to 8-32
 - summary (table), B-4
- default parameters (table), C-3 to C-4
- flex_configure_inhibits, 8-2 to 8-3
- flex_enable_home_inputs, 8-4 to 8-5
- flex_enable_limits, 8-6 to 8-8
- flex_load_sw_lim_pos, 8-9 to 8-10
- flex_read_home_input_status, 8-11 to 8-12
- flex_read_home_input_status_rtn, 8-11 to 8-12
- flex_read_limit_status, 8-13 to 8-14
- flex_read_limit_status_rtn, 8-13 to 8-14
- flex_set_home_polarity, 8-15 to 8-16
- flex_set_inhibit_momo, 8-17 to 8-18
- flex_set_limit_polarity, 8-19 to 8-20
- high-speed capture functions, 8-33 to 8-42
 - flex_enable_hs_caps, 8-34 to 8-35
 - flex_read_cap_pos, 8-36 to 8-37
 - flex_read_cap_pos_rtn, 8-36 to 8-37
 - flex_read_hs_cap_status, 8-38 to 8-40
 - flex_read_hs_cap_status_rtn, 8-38 to 8-40
 - flex_set_hs_cap_pol, 8-41 to 8-42
 - summary (table), B-4 to B-5
- summary (table), B-4 to B-5

- motion resources, 4-4 to 4-7
- ADC channels, 4-5 to 4-6
- DAC outputs, 4-6 to 4-7
- encoders, 4-4 to 4-5
- stepper outputs, 4-7
- motion trajectories, 4-14 to 4-20. *See also* trajectory control functions.
- trajectory parameters, 4-17 to 4-20
 - acceleration in RPS/s, 4-19
 - arc angles in degrees, 4-19 to 4-20
 - velocity in counts/s or steps/s, 4-18

- velocity in RPM, 4-18
- velocity override in percent, 4-19
- trajectory types and modes, 4-14 to 4-17
 - electronic gearing, 4-16
 - linear and circular interpolation, 4-16
 - move blending, 4-15
 - pull-in moves, 4-17
 - trapezoidal point-to-point position
 - control, 4-14 to 4-15
 - velocity control, 4-15
- move blending, 4-15
- move functions. *See also* blend functions.
 - flex_check_move_complete_status, 6-4 to 6-5
 - flex_wait_for_move_complete, 6-52 to 6-54
- MustOn/MustOff (MOMO) protocol functions
 - flex_set_bp_momo function, 8-31 to 8-32
 - flex_set_inhibit_momo function, 8-17 to 8-18
 - flex_set_port_momo function, 10-27 to 10-29
 - flex_set_status_momo function, 12-16 to 12-17

N

- National Instruments application software, 1-2
- National Instruments Web support, E-1 to E-2

O

- object management functions, 12-24 to 12-30
 - flex_load_description, 12-25
 - flex_object_mem_manage, 12-26 to 12-27
 - flex_read_description_rtn, 12-28
 - flex_read_registry_rtn, 12-29 to 12-30
 - summary (table), B-6

- onboard programming functions, 12-1 to 12-44
 - data operations functions, 12-31 to 12-44
 - flex_add_vars, 12-32
 - flex_and_vars, 12-33
 - flex_div_vars, 12-34
 - flex_load_var, 12-35
 - flex_lshift_var, 12-36 to 12-37
 - flex_mult_vars, 12-38
 - flex_not_var, 12-39
 - flex_or_vars, 12-40
 - flex_read_var, 12-41 to 12-42
 - flex_read_var_rtn, 12-41 to 12-42
 - flex_sub_vars, 12-43
 - flex_xor_vars, 12-44
 - summary (table), B-6 to B-7
 - flex_begin_store, 12-2 to 12-3
 - flex_end_store, 12-4
 - flex_insert_program_label, 12-5
 - flex_jump_label_on_condition, 12-6 to 12-10
 - flex_load_delay, 12-11
 - flex_pause_prog, 12-12
 - flex_read_program_status, 12-13 to 12-14
 - flex_run_prog, 12-15
 - flex_set_status_momo, 12-16 to 12-17
 - flex_stop_prog, 12-18
 - flex_wait_on_condition, 12-19 to 12-23
 - object management functions, 12-24 to 12-30
 - flex_load_description, 12-25
 - flex_object_mem_manage, 12-26 to 12-27
 - flex_read_description_rtn, 12-28
 - flex_read_registry_rtn, 12-29 to 12-30
 - summary (table), B-6
 - summary (table), B-6

- onboard variables
 - functions with more than one data parameter (table), D-1 to D-2
 - overview, 4-12
 - online problem-solving and diagnostic resources, E-1
 - operation mode, setting. *See* flex_set_op_mode function.
- P**
- packets, in host-FlexMotion board communication, 4-21
 - parameters
 - default parameters (table), C-1 to C-4
 - analog & digital I/O parameters, C-4
 - axis & resource configuration parameters, C-1 to C-2
 - motion I/O parameters, C-3 to C-4
 - trajectory parameters, C-2 to C-3
 - function types and parameters, 4-10 to 4-12
 - bitmapped versus per-resource functions, 4-10
 - input and return vectors, 4-11
 - onboard variables, 4-12
 - single and double-buffered parameters, 4-10 to 4-11
 - functions with more than one data parameter (table), D-1 to D-2
 - trajectory parameters, 4-17 to 4-20
 - per-axis configuration, in initialization, 4-13
 - per-resource functions versus bitmapped functions, 4-10
 - PID parameters
 - flex_load_pid_parameters, 5-19 to 5-20
 - flex_load_single_pid_parameter, 5-21 to 5-27
 - port functions
 - flex_read_port, 10-17 to 10-18
 - flex_read_port_rtn, 10-17 to 10-18
 - flex_set_port_direction, 10-25 to 10-26
 - flex_set_port_momo, 10-27 to 10-29
 - flex_set_port_pol, 10-30 to 10-31
 - position reference, establishing, in initialization, 4-13
 - primary data types (table), 3-2
 - problem-solving and diagnostic resources, online, E-1
 - programming functions, onboard. *See* onboard programming functions.
 - programming language considerations, 3-1 to 3-10
 - board identification parameter, 3-4
 - C/C++ for Windows, 3-4 to 3-6
 - data returned by reference, 3-4 to 3-5
 - data returned in arrays, 3-5
 - FlexMotion data structures, 3-5 to 3-6
 - FlexMotion Windows libraries, 2-1 to 2-3
 - function return status, 3-3
 - Read functions, 3-9 to 3-10
 - using functions with input vectors, 3-10
 - variable data types, 3-1 to 3-3
 - arrays, 3-2
 - primary types (table), 3-2
 - structures and other user-defined data types, 3-3
 - Visual Basic for Windows, 3-6 to 3-9
 - data returned by reference, 3-7
 - data returned in arrays, 3-7 to 3-8
 - u8 data type not supported, 3-6 to 3-7
 - user-defined data types, 3-8 to 3-9
 - proportional gain, changing, 5-22
 - pull-in moves, 4-17
 - pulse width modulation (PWM) functions
 - flex_configure_pwm_output, 10-4 to 10-6
 - flex_load_pwm_duty, 10-12

R

read functions

advanced functions

flex_read_csr_rtn, 13-12 to 13-13

advanced trajectory functions

flex_read_dac, 6-93 to 6-94

flex_read_dac_limit_status,
6-95 to 6-96flex_read_dac_limit_status_rtn,
6-95 to 6-96

flex_read_dac_rtn, 6-93 to 6-94

flex_read_steps_gen, 6-97 to 6-98

flex_read_steps_gen_rtn,
6-97 to 6-98

flex_read_target_pos, 6-99 to 6-100

flex_read_target_pos_rtn,
6-99 to 6-100flex_read_trajectory_data,
6-101 to 6-102flex_read_trajectory_data_rtn,
6-101 to 6-102

analog & digital I/O functions

flex_read_adc, 10-13 to 10-14

flex_read_adc_rtn, 10-13 to 10-14

flex_read_encoder, 10-15 to 10-16

flex_read_encoder_rtn,
10-15 to 10-16

flex_read_port, 10-17 to 10-18

flex_read_port_rtn, 10-17 to 10-18

breakpoint functions

flex_read_breakpoint_status,
8-29 to 8-30flex_read_breakpoint_status_rtn,
8-29 to 8-30

data operations functions

flex_read_var, 12-41 to 12-42

flex_read_var_rtn, 12-41 to 12-42

error & utility functions

flex_read_err_msg_rtn,
11-11 to 11-12

high-speed capture functions

flex_read_cap_pos, 8-36 to 8-37

flex_read_cap_pos_rtn, 8-36 to 8-37

flex_read_hs_cap_status,
8-38 to 8-40flex_read_hs_cap_status_rtn,
8-38 to 8-40

motion I/O functions

flex_read_home_input_status,
8-11 to 8-12flex_read_home_input_status_rtn,
8-11 to 8-12

flex_read_limit_status, 8-13 to 8-14

flex_read_limit_status_rtn,
8-13 to 8-14

object management functions

flex_read_description_rtn, 12-28

flex_read_registry_rtn,
12-29 to 12-30

onboard programming functions

flex_read_program_status,
12-13 to 12-14

programming considerations, 3-9 to 3-10

trajectory control functions

flex_read_axis_status, 6-20 to 6-23

flex_read_axis_status_rtn,
6-20 to 6-23

flex_read_blend_status, 6-24 to 6-26

flex_read_blend_status_rtn,
6-24 to 6-26

flex_read_follow_err, 6-27 to 6-28

flex_read_follow_err_rtn,
6-27 to 6-28

flex_read_mcs_rtn, 6-29 to 6-30

flex_read_pos, 6-31 to 6-32

flex_read_pos_rtn, 6-31 to 6-32

flex_read_rpm, 6-33 to 6-34

flex_read_rpm_rtn, 6-33 to 6-34

flex_read_trajectory_status,
6-35 to 6-38

- flex_read_trajectory_status_rtn, 6-35 to 6-38
- flex_read_velocity, 6-39 to 6-40
- flex_read_velocity_rtn, 6-39 to 6-40
- flex_read_vs_pos, 6-41 to 6-42
- flex_read_vs_pos_rtn, 6-41 to 6-42
- requirements for getting started, 1-2
- reset functions
 - flex_reset_defaults function, 13-14
 - flex_reset_encoder function, 10-19
 - flex_reset_pos function, 6-43 to 6-44
- resource configuration functions. *See* axis & resource configuration functions.
- resource IDs
 - ADC resource IDs (table), 4-6
 - axis resource IDs (table), 4-4
 - DAC resource IDs (table), 4-7
 - encoder resource IDs (table), 4-5
 - I/O port resource IDs (table), 4-8
 - purpose and use, 4-2
 - stepper output resource IDs (table), 4-7
 - vector space control resource IDs (table), 4-9
- return data buffer, in host-FlexMotion board communication, 4-21 to 4-22
- return status for functions, 3-3
- return vectors. *See* input and return vectors.

S

- setup functions. *See* configuration functions.
- shutdown function (flex_enable_shutdown), 13-9 to 13-10
- signal selection function (flex_select_signal), 10-20 to 10-22
- single and double-buffered parameters, 4-10 to 4-11
- software programming choices, 1-2. *See also* programming language considerations.
- software-related resources, E-2

- start & stop motion functions, 7-1 to 7-11
 - flex_blend, 7-1 to 7-11
 - flex_start, 7-1 to 7-11
 - flex_stop_motion, 7-8 to 7-11
 - summary (table), B-4
- stepper outputs
 - purpose and use, 4-7
 - resource IDs (table), 4-7
- structures, 3-3, 3-5 to 3-6
- system configuration, in initialization, 4-13

T

- technical support resources, E-1 to E-2
- trajectory control functions, 6-1 to 6-102
 - advanced trajectory functions, 6-72 to 6-102
 - flex_acquire_trajectory_data, 6-73 to 6-74
 - flex_load_base_vel, 6-75
 - flex_load_blend_fact, 6-76 to 6-78
 - flex_load_pos_modulus, 6-79
 - flex_load_rpm_thresh, 6-80 to 6-81
 - flex_load_scurve_time, 6-82 to 6-83
 - flex_load_torque_lim, 6-84 to 6-86
 - flex_load_torque_offset, 6-87 to 6-88
 - flex_load_vel_override, 6-91 to 6-92
 - flex_load_vel_threshold, 6-89 to 6-90
 - flex_read_dac, 6-93 to 6-94
 - flex_read_dac_limit_status, 6-95 to 6-96
 - flex_read_dac_limit_status_rtn, 6-95 to 6-96
 - flex_read_dac_rtn, 6-93 to 6-94
 - flex_read_steps_gen, 6-97 to 6-98
 - flex_read_steps_gen_rtn, 6-97 to 6-98
 - flex_read_target_pos, 6-99 to 6-100

- flex_read_target_pos_rtn, 6-99 to 6-100
- flex_read_trajectory_data, 6-101 to 6-102
- flex_read_trajectory_data_rtn, 6-101 to 6-102
- summary (table), B-3
- arcs functions, 6-55 to 6-62
 - flex_load_circular_arc, 6-56 to 6-57
 - flex_load_helical_arc, 6-58 to 6-59
 - flex_load_spherical_arc, 6-60 to 6-62
 - summary (table), B-3
- default parameters (table), C-2 to C-3
- flex_check_blend_complete_status, 6-2 to 6-3
- flex_check_move_complete_status, 6-4 to 6-5
- flex_load_acceleration, 6-6 to 6-7
- flex_load_follow_err, 6-8 to 6-9
- flex_load_rpm, 6-10 to 6-11
- flex_load_rpsps, 6-12 to 6-13
- flex_load_target_pos, 6-14 to 6-15
- flex_load_velocity, 6-16 to 6-17
- flex_load_vs_pos, 6-18 to 6-19
- flex_read_axis_status, 6-20 to 6-23
- flex_read_axis_status_rtn, 6-20 to 6-23
- flex_read_blend_status, 6-24 to 6-26
- flex_read_blend_status_rtn, 6-24 to 6-26
- flex_read_follow_err, 6-27 to 6-28
- flex_read_follow_err_rtn, 6-27 to 6-28
- flex_read_mcs_rtn, 6-29 to 6-30
- flex_read_pos, 6-31 to 6-32
- flex_read_pos_rtn, 6-31 to 6-32
- flex_read_rpm, 6-33 to 6-34
- flex_read_rpm_rtn, 6-33 to 6-34
- flex_read_trajectory_status, 6-35 to 6-38
- flex_read_trajectory_status_rtn, 6-35 to 6-38
- flex_read_velocity, 6-39 to 6-40
- flex_read_velocity_rtn, 6-39 to 6-40
- flex_read_vs_pos, 6-41 to 6-42
- flex_read_vs_pos_rtn, 6-41 to 6-42
- flex_reset_pos, 6-43 to 6-44
- flex_set_op_mode, 6-45 to 6-48
- flex_wait_for_blend_complete, 6-49 to 6-51
- flex_wait_for_move_complete, 6-52 to 6-54
- gearing functions, 6-63 to 6-71
 - flex_config_gear_master, 6-64 to 6-65
 - flex_enable_gearing, 6-66 to 6-67
 - flex_enable_gearing_single_axis, 6-68 to 6-69
 - flex_load_gear_ratio, 6-70 to 6-71
 - summary (table), B-3
- summary (table), B-1 to B-2
- trajectory parameters, 4-17 to 4-20
 - acceleration in RPS/s, 4-19
 - arc angles in degrees, 4-19 to 4-20
 - initializing, 4-13
 - velocity in counts/s or steps/s, 4-18
 - velocity in RPM, 4-18
 - velocity override in percent, 4-19
- trajectory types and modes, 4-14 to 4-17
 - electronic gearing, 4-16
 - linear and circular interpolation, 4-16
 - move blending, 4-15
 - pull-in moves, 4-17
 - trapezoidal point-to-point position control, 4-14 to 4-15
 - velocity control, 4-15
- trapezoidal point-to-point position control, 4-14 to 4-15

U

- u8 data type not supported, Visual Basic for Windows, 3-6 to 3-7
- user-defined data types
 - programming considerations, 3-3
 - Visual Basic for Windows, 3-8 to 3-9
- utility functions. *See* error & utility functions.

V

- ValueMotion to FlexMotion function
 - cross-reference (table), B-7 to B-10
- variable data types, 3-1 to 3-3
 - arrays, 3-2
 - primary types (table), 3-2
 - structures and other user-defined data types, 3-3
- variable manipulation functions. *See* data operations functions.
- variables, onboard
 - functions with more than one data parameter (table), D-1 to D-2
 - overview, 4-12
- vector spaces
 - 3D resources (figure), 4-9
 - control resource IDs (table), 4-9
 - purpose and use, 4-8 to 4-10
- velocity control, 4-15
- velocity feedback gain, changing, 5-25 to 5-26
- velocity feedforward gain, changing, 5-26 to 5-27
- velocity functions
 - flex_load_base_vel, 6-75
 - flex_load_velocity, 6-16 to 6-17
 - flex_load_vel_override, 6-91 to 6-92
 - flex_load_vel_tc_rs, 5-28 to 5-29
 - flex_load_vel_threshold, 6-89 to 6-90
 - flex_read_velocity, 6-39 to 6-40
 - flex_read_velocity_rtn, 6-39 to 6-40
- velocity in counts/s or steps/s, 4-18
- velocity in RPM, 4-18

velocity override in percent, 4-19

Visual Basic for Windows

- creating 32-bit Windows applications, 2-3
- programming considerations, 3-6 to 3-9
 - data returned by reference, 3-7
 - data returned in arrays, 3-7 to 3-8
 - u8 data type not supported, 3-6 to 3-7
 - user-defined data types, 3-8 to 3-9

W

- watchdog timer function
 - (flex_enable_1394_watchdog), 13-7
- Web support from National Instruments, E-1 to E-2
 - online problem-solving and diagnostic resources, E-1
 - software-related resources, E-2
- Windows libraries. *See* FlexMotion Windows libraries.
- Worldwide technical support, E-2