

COMPREHENSIVE SERVICES

We offer competitive repair and calibration services, as well as easily accessible documentation and free downloadable resources.

SELL YOUR SURPLUS

We buy new, used, decommissioned, and surplus parts from every NI series. We work out the best solution to suit your individual needs.

 Sell For Cash  Get Credit  Receive a Trade-In Deal

OBSOLETE NI HARDWARE IN STOCK & READY TO SHIP

We stock **New**, **New Surplus**, **Refurbished**, and **Reconditioned** NI Hardware.



Bridging the gap between the manufacturer and your legacy test system.

 1-800-915-6216

 www.apexwaves.com

 sales@apexwaves.com

All trademarks, brands, and brand names are the property of their respective owners.

Request a Quote

 **CLICK HERE**

PCIe-7846

CALIBRATION PROCEDURE

NI R Series

NI PCI-783xR, NI PCIe-784xR, NI PXI-784xR, NI PXIe-784xR,
NI USB-784xR, NI PCIe-785xR, NI PXI-785xR, NI PXIe-785xR,
NI USB-785xR, NI PXIe-786xR, and NI PXIe-786x

This document contains the verification and adjustment procedures for NI R Series devices.
For more information about calibration solutions, visit ni.com/calibration.

Contents

Software.....	1
Documentation.....	2
Test Equipment.....	6
Test Conditions.....	7
Initial Setup.....	7
Self-Calibration.....	7
As-Found and As-Left Limits.....	8
Verification.....	8
Analog Input Accuracy Verification.....	8
Analog Output Accuracy Verification.....	10
Counter Verification.....	11
Adjustment.....	12
Reverification.....	13
Worldwide Support and Services.....	14

Software

Calibrating NI R Series devices requires installation of software on the calibration system.
Refer to the following table for the correct software version for your bus.

Table 1. Required Software for NI R Series

Device	Required Software Version
PCI-78xxR, PCIe-78xxR, PXI-78xxR	<ul style="list-style-type: none"> • LabVIEW 8.6 or later • NI-RIO driver software version 3.1¹ or later
PXIe-785xR	<ul style="list-style-type: none"> • LabVIEW 2016 or later • NI R Series Multifunction RIO Device Drivers August 2016 or later
PXIe-786xR	<ul style="list-style-type: none"> • LabVIEW 2017 or later • NI R Series Multifunction RIO Device Drivers July 2017 or later
PXIe-786x	<ul style="list-style-type: none"> • LabVIEW 2018 or later • NI R Series Multifunction RIO Device Drivers May 2018 or later
USB-784xR	<ul style="list-style-type: none"> • LabVIEW 2013 or later • NI-RIO driver software version 13.1 or later
USB-785xR	<ul style="list-style-type: none"> • LabVIEW 2013 or later • NI-RIO driver software version 13.0 or later

Documentation

Consult the following documents for information about NI R Series devices, LabVIEW, and driver software. All documents are available on ni.com/manuals and help files install with the software.



Getting Started with NI R Series Multifunction RIO Getting Started Guide

NI PCI-781xR, NI PXI-781xR, NI PCI-783xR, NI PXI-783xR, NI PCIe-784xR, NI PXI-784xR, NI PCIe-785xR, and NI PXI-785xR specific information



NI R Series Multifunction RIO Specifications

NI PCI-781xR, NI PXI-781xR, NI PCI-783xR, NI PXI-783xR, NI PCIe-784xR, NI PXI-784xR, NI PCIe-785xR, and NI PXI-785xR specifications and calibration interval

¹ You can use NI-RIO driver software version 3.0 with patch



NI R Series Multifunction RIO User Manual

NI PCI-781xR, NI PXI-781xR, NI PCI-783xR, NI PXI-783xR, NI PCIe-784xR, NI PXI-784xR, NI PCIe-785xR, and NI PXI-785xR specific information



NI PXIe-7846R Getting Started Guide

NI PXIe-7846R specific information



NI PXIe-7846R Specifications

NI PXIe-7846R specifications and calibration interval



NI PXIe-7846R User Manual

NI PXIe-7846R specific information



NI PXIe-7847R Getting Started Guide

NI PXIe-7847R specific information



NI PXIe-7847R Specifications

NI PXIe-7847R specifications and calibration interval



NI PXIe-7847R User Manual

NI PXIe-7847R specific information



NI PXIe-7856R Getting Started Guide

NI PXIe-7856R specific information



NI PXIe-7856R Specifications

NI PXIe-7856R specifications and calibration interval



NI PXIe-7856R User Manual

NI PXIe-7856R specific information



NI PXIe-7857R Getting Started Guide

NI PXIe-7857R specific information



NI PXIe-7857R Specifications

NI PXIe-7857R specifications and calibration interval



NI PXIe-7857R User Manual

NI PXIe-7857R specific information



NI PXIe-7858R Getting Started Guide

NI PXIe-7858R specific information



NI PXIe-7858R Specifications

NI PXIe-7858R specifications and calibration interval



NI PXIe-7858R User Manual

NI PXIe-7858R specific information



NI PXIe-7861 Getting Started Guide

NI PXIe-7861 specific information



NI PXIe-7861 Specifications

NI PXIe-7861 specifications and calibration interval



NI PXIe-7861 User Manual

NI PXIe-7861 specific information



NI PXIe-7862 Getting Started Guide

NI PXIe-7862 specific information



NI PXIe-7862 Specifications

NI PXIe-7862 specifications and calibration interval



NI PXIe-7862 User Manual

NI PXIe-7862 specific information



NI PXIe-7867R Getting Started Guide

NI PXIe-7867R specific information



NI PXIe-7867R Specifications

NI PXIe-7867R specifications and calibration interval



NI PXIe-7867R User Manual

NI PXIe-7867R specific information



NI PXIe-7868R Getting Started Guide
NI PXIe-7868R specific information



NI PXIe-7868R Specifications
NI PXIe-7868R specifications and calibration interval



NI PXIe-7868R User Manual
NI PXIe-7868R specific information



NI USB-7845R Getting Started Guide
NI USB-7845R specific information



NI USB-7845R Specifications
NI USB-7845R specifications and calibration interval



NI USB-7845R User Manual
NI USB-7845R specific information



NI USB-7846R Getting Started Guide
NI USB-7846R specific information



NI USB-7846R Specifications
NI USB-7846R specifications and calibration interval



NI USB-7846R User Manual
NI USB-7846R specific information



NI USB-7855R Getting Started Guide
NI USB-7855R specific information



NI USB-7855R Specifications
NI USB-7855R specifications and calibration interval



NI USB-7855R User Manual
NI USB-7855R specific information



NI USB-7856R Getting Started Guide
NI USB-7856R specific information



NI USB-7856R Specifications

NI USB-7856R specifications and calibration interval



NI USB-7856R User Manual

NI USB-7856R specific information



LabVIEW Help

LabVIEW programming concepts and reference information



NI-RIO Help

NI-RIO and Multifunction RIO Device Drivers reference information

Test Equipment

The following table lists the equipment recommended for the performance verification and adjustment procedures. If the recommended equipment is not available, select a substitute using the requirements listed.

Table 2. Recommended Equipment

Equipment	Recommended Model	Requirements
Calibrator	Fluke 5700A	Use a high-precision voltage source that is 10 ppm or less.
DMM	NI 4070	Use a multiranging 6½-digit DMM with an accuracy of 250 ppm.
Counter	Agilent 53131A	Use a counter accurate to 0.01%.
Low thermal copper EMF plug-in cables	Fluke 5440A-7002	Do not use standard banana cables.
Shielded MIO cable	NI SHC68-68-RMIO	Use this high-performance shielded cable, designed specifically for R Series devices, when calibrating the NI R Series device.

Table 2. Recommended Equipment (Continued)

Equipment	Recommended Model	Requirements
Accessory	NI SCB-68A	The SCB-68A is a shielded I/O connector block with 68 screw terminals for easy signal connection to the R Series devices.
	NI CB-68LP, NI TBX-68, NI CB-68LPR	The CB-68LP, CB-68LPR, and TBX-68 are low-cost termination accessories with 68 screw terminals for easy signal connection to the R Series devices.

Test Conditions

The following setup and environmental conditions are required to ensure the device meets published specifications.

- Keep connections to the device as short as possible. Long cables and wires act as antennas, picking up extra noise that can affect measurements.
- Use shielded copper wire for all cable connections to the device. Use twisted-pairs wire to eliminate noise and thermal offsets.
- Maintain an ambient temperature of $23\text{ }^{\circ}\text{C} \pm 5\text{ }^{\circ}\text{C}$. The device temperature will be greater than the ambient temperature.
- Keep relative humidity below 80%.
- Allow a warm-up time of at least 15 minutes to ensure that the device measurement circuitry is at a stable operating temperature.

Initial Setup

Refer to your getting started guide for your device for information about how to install the software and hardware.



Note You can access all of the NI R Series VIs for calibration at `<labview>\vi.lib\LabVIEW Targets\FPGA\RIO\R Series\78XXR\783XR\Calibration\Public`.

Self-Calibration

Complete the following steps to self-calibrate the device.



Note No signal connections are needed for self-calibration.

1. Wait 15 minutes for the device to warm-up.

2. Launch the self-calibration VI `nirio78xxCalibrationSelfCal.vi`.
3. Call self-calibration before doing the first verification.
4. Pass a `TRUE` to `Save Cal Results` to save the constants to the user portion of the flash memory. If you pass `False`, the constants are then discarded.
 - For NI PCI R Series and NI PCIe R Series, the device automatically loads the saved constants to the calibration DAC at power-on. The calibration constants are loaded to the FPGA for fixed point scaling after a VI is downloaded.
 - For NI USB R Series and NI PXIe R Series, the device automatically loads the saved constants for fixed point scaling.

As-Found and As-Left Limits

The as-found (1-Year) limits are the published specifications for the NI R Series devices. NI uses these limits to determine whether the NI R Series devices meets the specifications when it is received for calibration. Use the as-found limits during initial verification.

The as-left (24-Hour) calibration limits are equal to the published NI specifications for the NI R Series devices, less guard bands for measurement uncertainty, temperature drift, and drift over time. NI uses these limits to reduce the probability that the instrument will be outside the published specification limits at the end of the calibration cycle. Use the as-left limits when performing verification after adjustment.

Verification

The following performance verification procedures describe the sequence of operation and provide test points required to verify the NI R Series devices. The verification procedures assume that adequate traceable uncertainties are available for the calibration references.

Analog Input Accuracy Verification

Complete the following procedure to determine the As-Found status of the NI R Series devices.

1. Connect the NI R Series device to the calibrator as shown in the following figure.

Figure 1. Analog Input Verification Connections

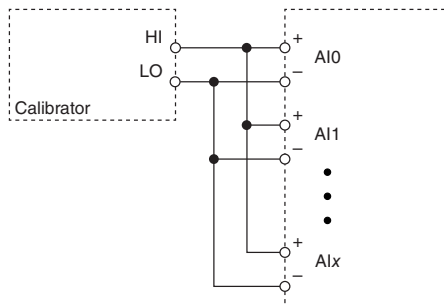

2. If your calibrator has a guard connection, connect that terminal to AI GND.
3. Set the calibrator voltage to a Test Point value indicated in the following *Analog Input Accuracy Verification Test Limits* tables.

Table 3. Analog Input Accuracy Verification Test Limits for NI PCI R Series

Range (V)		Test Point		24-Hour Limits		1-Year Limits	
Minimum	Maximum	Location	Value (V)	Lower Limit (V)	Upper Limit (V)	Lower Limit (V)	Upper Limit (V)
-10	10	Positive full-scale	9.90	9.892386	9.907614	9.892270	9.907730
		0	0	-0.002707	0.002707	-0.002707	0.002707
		Negative full-scale	-9.90	-9.907614	-9.892386	-9.907730	-9.892270

Table 4. Analog Input Accuracy Verification Test Limits for NI PCIe R Series, and NI PXI R Series

Range (V)		Test Point		24-Hour Limits		1-Year Limits	
Minimum	Maximum	Location	Value (V)	Lower Limit (V)	Upper Limit (V)	Lower Limit (V)	Upper Limit (V)
-10	10	Positive full-scale	9.90	9.89648	9.90352	9.89606	9.90394
		0	0	-0.00168	0.00168	-0.00168	0.00168
		Negative full-scale	-9.90	-9.90352	-9.89648	-9.90394	-9.89606

Table 5. Analog Input Accuracy Verification Test Limits for NI PXIe R Series and NI USB R Series

Range (V)		Test Point		24-Hour Limits		1-Year Limits	
Minimum	Maximum	Location	Value (V)	Lower Limit (V)	Upper Limit (V)	Lower Limit (V)	Upper Limit (V)
-10	10	Positive full-scale	10	9.998416	10.001584	9.997717	10.002283
		0	0	-0.000639	0.000639	-0.000639	0.000639
		Negative full-scale	-10	-10.001584	-9.998416	-10.002283	-9.997717

Table 5. Analog Input Accuracy Verification Test Limits for NI PXIe R Series and NI USB R Series (Continued)

Range (V)		Test Point		24-Hour Limits		1-Year Limits	
Minimum	Maximum	Location	Value (V)	Lower Limit (V)	Upper Limit (V)	Lower Limit (V)	Upper Limit (V)
-5	5	Positive full-scale	5	4.999180	5.000820	4.998830	5.001170
		0	0	-0.000340	0.000340	-0.000340	0.000340
		Negative full-scale	-5	-5.000820	-4.999180	-5.001170	-4.998830
-2	2	Positive full-scale	2	1.999661	2.000339	1.999521	2.000479
		0	0	-0.000137	0.000137	-0.000137	0.000137
		Negative full-scale	-2	-2.000339	-1.999661	-2.000479	-1.999521
-1	1	Positive full-scale	1	0.999817	1.000183	0.999748	1.000252
		0	0	-0.000074	0.000074	-0.000074	0.000074
		Negative full-scale	-1	-1.000183	-0.999817	-1.000252	-0.999748

4. Measure the analog input voltage on each channel by calling `nirio78xxCalibrationReadAIVoltage.vi`.
5. Compare the measured voltage with the 1-year limits from the *Analog Input Accuracy Verification Test Limits* tables to verify the input accuracy. If the value is within these limits, the device passes the test.
6. Repeat steps 3 through 5 for each test point in the *Analog Input Accuracy Verification Test Limits* tables.

Analog Output Accuracy Verification

Complete the following procedure to determine the As-Found status of the NI R Series devices.

1. Connect the NI R Series device to the DMM as shown in the following figure.

Figure 2. Analog Output Verification Connections

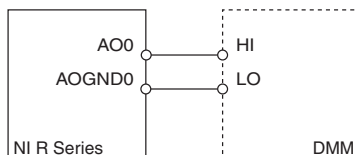

2. Set the DMM measurement range to **10 V**.
3. Measure the analog output voltage on each channel by calling `nirio78xxCalibrationSetAOVoltage.vi`.
4. Compare the resulting value shown by the DMM to the 1-year limits in the following *Analog Output Accuracy Verification Test Limits* tables. If the value is within these limits, the device passes the test.

Table 6. Analog Output Accuracy Verification Test Limits for NI PCI R Series, NI PCIe R Series, and NI PXI R Series

Range (V)		Test Point		24-Hour Limits		1-Year Limits	
Minimum	Maximum	Location	Value (V)	Lower Limit (V)	Upper Limit (V)	Lower Limit (V)	Upper Limit (V)
-10	10	Positive full-scale	9.90	9.894320	9.905680	9.894155	9.905845
		0	0.0	-0.002366	0.002366	-0.002366	0.002366
		Negative full-scale	-9.90	-9.905680	-9.894320	-9.905845	-9.894155

Table 7. Analog Output Accuracy Verification Test Limits for NI PXIe R Series and NI USB R Series

Range (V)		Test Point		24-Hour Limits		1-Year Limits	
Minimum	Maximum	Location	Value (V)	Lower Limit (V)	Upper Limit (V)	Lower Limit (V)	Upper Limit (V)
-10	10	Positive full-scale	10	9.997852	10.002148	9.997502	10.002498
		0	0.0	-0.001099	0.001099	-0.001099	0.001099
		Negative full-scale	-10	-10.002148	-9.997852	-10.002498	-9.997502

5. Repeat steps 3 through 4 for each test point in the *Analog Output Accuracy Verification Test Limits* tables.
6. Disconnect the DMM from the NI R Series device.
7. Repeat steps 1 through 6 for all AO channels on the device.

Counter Verification

Complete the following procedure to determine the As-Found status of the NI R Series devices.

1. Connect the NI R Series device to the counter as shown in the following figure.

Figure 3. Counter Verification Connections

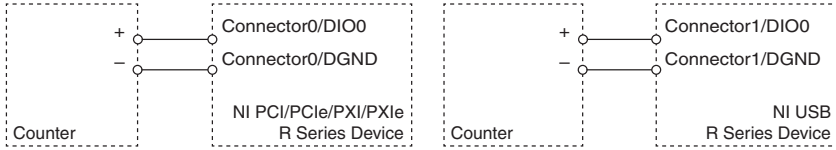

Note The Agilent 53131A counter uses BNC connectors on its channels and has no HI or LO inputs. Connections on the Agilent 53131A must be made using BNC (50 Ω) to the patch cords or adapter.

2. Generate the counter output signal by calling `nirio78xxCalibrationStartCounter.vi`. This VI causes the device to begin outputting a square-wave on ConnectorX/DIO0 at 5 MHz.
3. Compare the value read by your counter to the test limits shown in the following *NI R Series Counter Verification Test Limits* table. If the value is within these limits, the device passes the test.

Table 8. NI R Series Counter Verification Test Limits

Set Point (MHz)	Lower Limit (MHz)	Upper Limit (MHz)
5.0	4.999500	5.000500

4. Stop the generation by calling `nirio78xxCalibrationStopCounter.vi`.
5. Disconnect the counter from your device.



Note If the Counter Verification procedure determines that the NI R Series device is outside of the limits, refer to the *Worldwide Support and Services* section for assistance in returning the device to NI.

Adjustment

The following performance adjustment procedure describes the sequence of operation required to adjust the NI R Series devices.



Note

- If the NI R Series device successfully passed each of the verification procedures within the 24-hour test limits, then an adjustment is not required.
- If the NI R Series device is not within the 1-year test limits, then adjustment is recommended to guarantee the published specifications for the next year.

- Following the adjustment procedure automatically updates the calibration date and temperature in the external calibration area of the onboard flash memory of the NI R Series device.
- If an adjustment is not required use the `nirio78xxCalibrationUpdateExtCalDate.vi` to update the External Calibration date.

Complete the following procedure to adjust the calibration constants performance of the NI R Series device.

1. Set the calibrator to Standby mode (STBY).
2. Connect your device to the calibrator.
3. Initialize the external calibration process by calling `nirio78xxRCalibrationAdjustExtCal.vi`. Set the Action to `Initialize`. This action is password-protected and the default password is `NI`. You do not need to input values for Comments or Current Calibrator Value.
4. Determine the value of the NI R Series device onboard reference by completing the following steps.
 - a) Call `nirio78xxCalibrationAdjustExtCal.vi`. Set the Action to `CalibrateOnboardReference` and pass the Current Calibrator Value of 0 V to the VI for the first iteration. `nirio78xxCalibrationAdjustExtCal.vi` then performs measurements and determines a new Requested Calibrator Value.
 - b) Program the calibrator to output the Requested Calibrator Value. At this point, you must wait to ensure that the calibrator output has settled completely.
 - c) Repeat steps a and b until the Reference Calibration Done output becomes `TRUE`. With each new iteration of these steps, input the Requested Calibrator Value returned from the previous iteration.
5. Adjust the NI R Series device external calibration constants by calling `nirio78xxCalibrationAdjustExtCal.vi`. Set the Action to `AdjustCalibration`.
6. Save the calibration adjustment values to the onboard flash memory using `nirio78xxCalibrationAdjustExtCal.vi`. Set the Action to `CommitAndClose`.
 - a) If you would prefer to cancel the calibration, you call this VI and set the Action to `CancelAndClose`. A comment input is provided for storing any comments related to your calibration.
7. Disconnect the calibrator from the device.

Reverification

Repeat the *Verification* section to determine the As-Left status of the device.



Note If any test fails Reverification after performing an adjustment, verify that you have met the Test Conditions before returning your device to NI. Refer to the *Worldwide Support and Services* section for assistance in returning the device to NI.

Worldwide Support and Services

The NI website is your complete resource for technical support. At ni.com/support, you have access to everything from troubleshooting and application development self-help resources to email and phone assistance from NI Application Engineers.

Visit ni.com/services for information about the services NI offers.

Visit ni.com/register to register your NI product. Product registration facilitates technical support and ensures that you receive important information updates from NI.

NI corporate headquarters is located at 11500 North Mopac Expressway, Austin, Texas, 78759-3504. NI also has offices located around the world. For support in the United States, create your service request at ni.com/support or dial 1 866 ASK MYNI (275 6964). For support outside the United States, visit the *Worldwide Offices* section of ni.com/niglobal to access the branch office websites, which provide up-to-date contact information.

Information is subject to change without notice. Refer to the *NI Trademarks and Logo Guidelines* at ni.com/trademarks for information on NI trademarks. Other product and company names mentioned herein are trademarks or trade names of their respective companies. For patents covering NI products/technology, refer to the appropriate location: **Help»Patents** in your software, the `patents.txt` file on your media, or the *National Instruments Patent Notice* at ni.com/patents. You can find information about end-user license agreements (EULAs) and third-party legal notices in the `readme` file for your NI product. Refer to the *Export Compliance Information* at ni.com/legal/export-compliance for the NI global trade compliance policy and how to obtain relevant HTS codes, ECCNs, and other import/export data. NI MAKES NO EXPRESS OR IMPLIED WARRANTIES AS TO THE ACCURACY OF THE INFORMATION CONTAINED HEREIN AND SHALL NOT BE LIABLE FOR ANY ERRORS. U.S. Government Customers: The data contained in this manual was developed at private expense and is subject to the applicable limited rights and restricted data rights as set forth in FAR 52.227-14, DFAR 252.227-7014, and DFAR 252.227-7015.

© 2016—2018 National Instruments. All rights reserved.

372004H-01 July 19, 2018