

## COMPREHENSIVE SERVICES

We offer competitive repair and calibration services, as well as easily accessible documentation and free downloadable resources.

## SELL YOUR SURPLUS

We buy new, used, decommissioned, and surplus parts from every NI series. We work out the best solution to suit your individual needs.

 Sell For Cash    Get Credit    Receive a Trade-In Deal

## OBSOLETE NI HARDWARE IN STOCK & READY TO SHIP

We stock **New**, **New Surplus**, **Refurbished**, and **Reconditioned** NI Hardware.



*Bridging the gap between the manufacturer and your legacy test system.*

 1-800-915-6216

 [www.apexwaves.com](http://www.apexwaves.com)

 [sales@apexwaves.com](mailto:sales@apexwaves.com)

*All trademarks, brands, and brand names are the property of their respective owners.*

**Request a Quote**

 **CLICK HERE**

**PCIe-8237**

## PRODUCT FLYER

# NI Frame Grabbers

### CONTENTS

[NI Frame Grabbers](#)

[Detailed View of NI Frame Grabbers](#)

[Key Features](#)

[Vision Software](#)

[Platform-Based Approach for Test and Measurement](#)

[Hardware Services](#)

# NI Frame Grabbers

PCIe-1427, PCI-1428, PCIe-1430, PCIe-1433, PXIe-1435, PCIe-1473, NI 1483, PCIe-8233, PXIe-8234, PCIe-8236, PCIe-8237, PCIe-8242, and PCIe-8244



- Form factor—PCI, PCI Express, PXI, PXI Express
- Camera bus—GigE Vision, USB3 Vision, Camera Link
- Open camera connectivity so you can use the camera vendor of your choice
- FPGA image processing without the need for traditional FPGA design knowledge
- Integration of I/O such as data acquisition and industrial communications
- OS—Windows 10, Windows 7, and NI Linux Real-Time

## The Best Choice for Ultra-High Performance Vision Applications

With NI Frame Grabbers for PCI, PCI Express, PXI, and PXI Express, you can connect to industry-standard camera buses including GigE Vision, USB3 Vision, and Camera Link. With options for inline FPGA processing, these frame grabbers are ideal for high-performance scientific or machine vision applications that require high-resolution and/or high-speed digital imaging.

Table 1. NI Frame Grabbers for GigE Vision Cameras

	PCIe-8233	PCIe-8236	PCIe-8237	PXIe-8234
Camera Interface	GigE Vision			
Number of Ports	4	2	2	2
Bus Power	Power over Ethernet (PoE)	Power over Ethernet (PoE)	Power over Ethernet (PoE)	--
FPGA	No	No	Spartan-6 LX25 (I/O Only)	No

Table 2. NI Frame Grabbers for USB3 Vision Cameras

	PCIe-8242	PCIe-8244
Camera Interface	USB3 Vision	
Bus Power	Yes	

Table 3. NI Frame Grabbers for Camera Link Cameras

	PCIe-1427	PCI-1428	PCIe-1430	PCIe-1433	PXIe-1435	PCIe-1473	NI 1483
Camera Interface	Camera Link						
Number of Ports	1	1	2	2	2	2	2
Bus Power	--	--	--	Power over Camera Link	Power over Camera Link	Power over Camera Link	--
FPGA	--	--	--	--	--	Virtex-5 LX50/LX110	See Note <sup>1</sup>
Configuration	Base	Medium	Dual-Base	80-Bit*	80-Bit*	80-Bit <sup>2</sup>	80-Bit
Pixel Clock	80 MHz	50 MHz	85 MHz	85 MHz	85 MHz	85 MHz	85 MHz

<sup>1</sup>The NI 1483 is a Camera Link Adaptor Module for FlexRIO. FlexRIO modules offer FPGAs up to Xilinx Kintex-7 410T.

<sup>2</sup>Only the 10-tap, 8-bit tap configuration is supported for 80-bit mode.

# Detailed Views of NI Frame Grabbers

## PCIe-8237

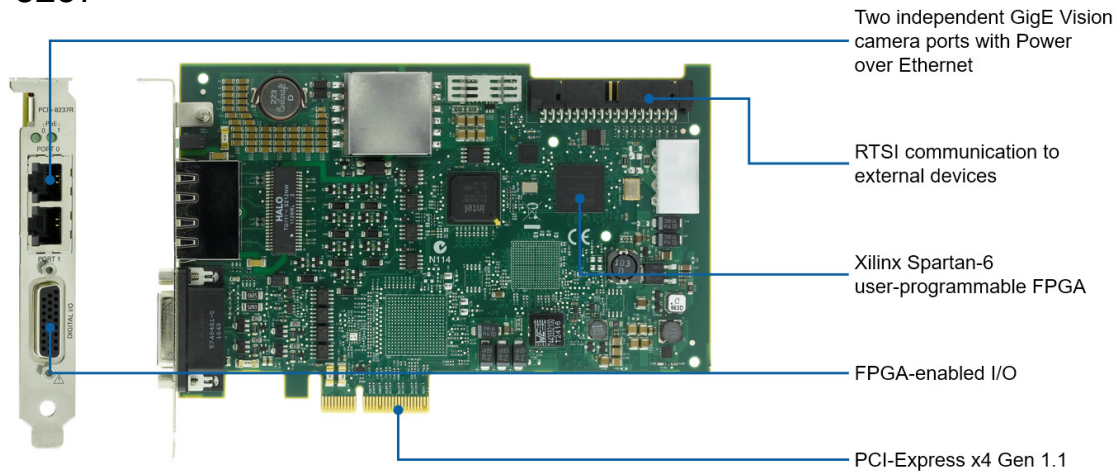

## PCIe-1473

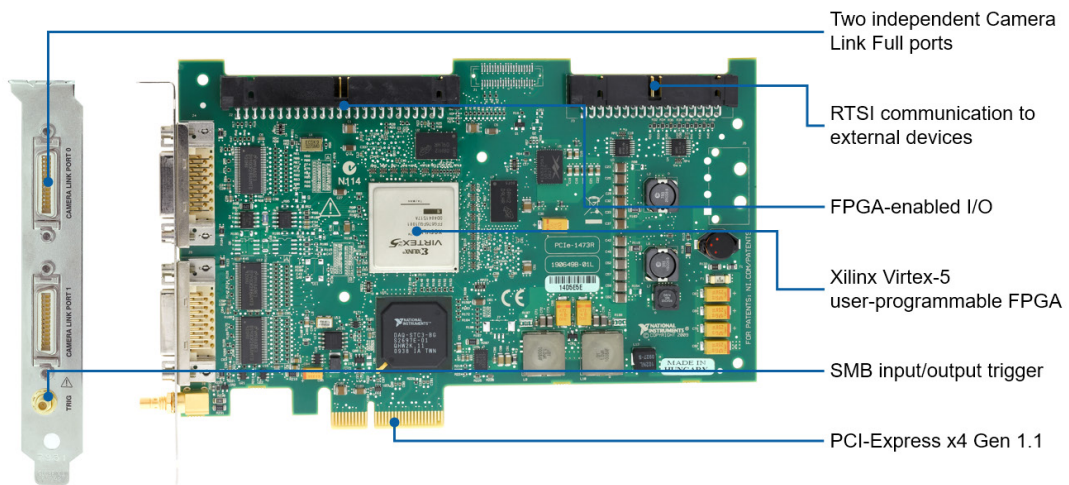

## NI 1483 and PXIe-7975

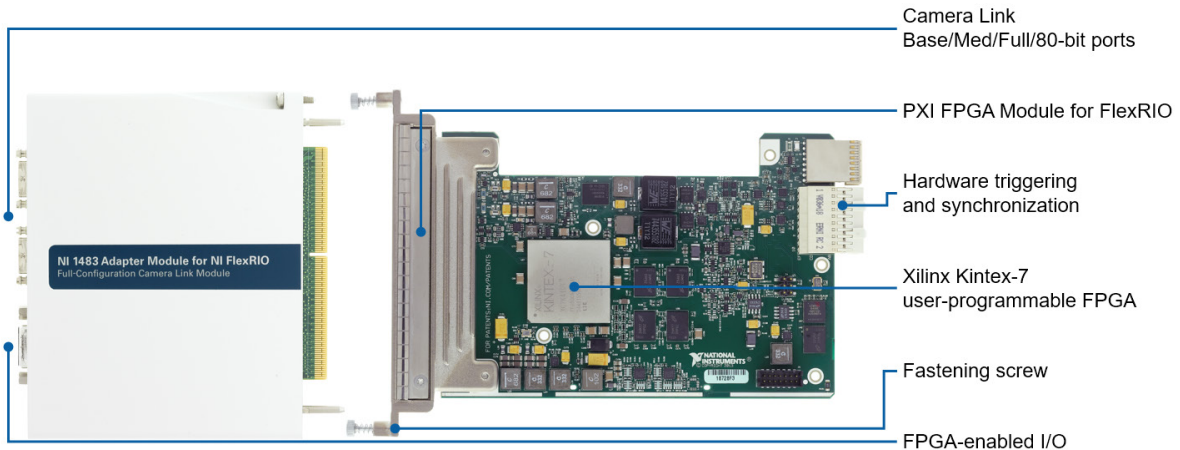

# Key Features

## Inline FPGA Processing

In an inline FPGA processing architecture, the camera interface is connected directly to the pins of the FPGA; there the pixels are passed directly to the FPGA as they are sent from the camera. This architecture is commonly used with Camera Link cameras because their acquisition logic is easily implemented using digital circuitry on the FPGA. This architecture has two main benefits. First, it offloads some of the work from the CPU to the FPGA by performing preprocessing functions on the FPGA. For example, you can use the FPGA for high-speed preprocessing functions such as filtering or thresholding to preprocess the image before sending it to the CPU, which effectively reduces its workload. It also reduces the amount of data that the CPU must process by implementing logic to capture the pixels from only regions of interest. The second benefit of this architecture is that it enables you to perform high-speed control operations directly on the FPGA without using the CPU. This means that you can use the FPGA to process the image as it is sent from the camera and then make control decisions based on the processing results. An example is high-speed sorting for which you can use the FPGA to send pulses to an actuator that then ejects or sorts parts as they pass by.

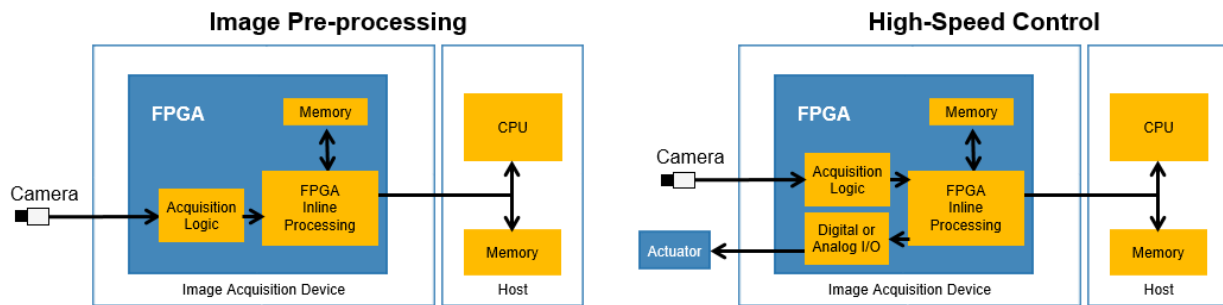

Figure 1. Use cases for inline FPGA image processing

In addition to the hundreds of machine vision algorithms included in the Vision Development Module, you can choose from over 50 algorithms specifically for use on NI's FPGA hardware targets. These preoptimized functions support many different image types. The Vision Development Module also includes the necessary communication and synchronization functions to efficiently transfer images and processing results between the CPU and FPGA.

## FPGA-Enabled I/O

With NI Frame Grabbers, you can use FPGAs for more powerful I/O. Frame Grabber Device models that offer user-programmable FPGAs include a prebuilt FPGA personality called Vision RIO. This turnkey IP set allows you to take advantage of FPGA-enabled I/O without ever having to program the FPGA. Without FPGA programming knowledge, you can use Vision RIO to configure a queue of pulses, set line states, and enable hardware-timed IEEE 1588 to provide a reliable, hardware-timed method of synchronizing I/O with visually inspected parts. Using the Vision RIO API, you can configure several different scenarios, including triggered acquisition with multiple encoder- and proximity-controlled ejectors, and manage ejectors controlled with PLC-issued timestamps.



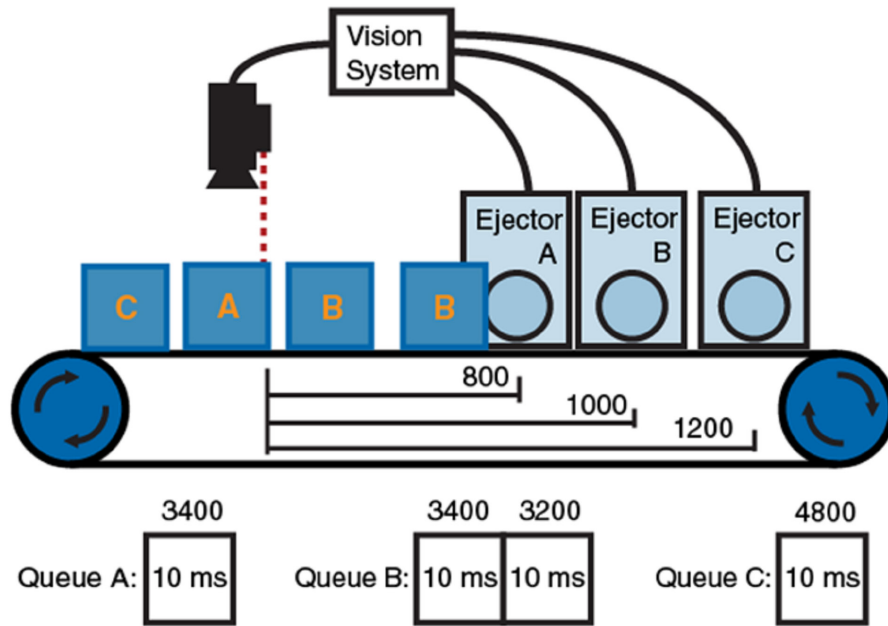

Figure 2. Example of a triggered acquisition scenario with multiple encoder-controlled ejectors

Beyond the Vision RIO API, you can take advantage of the LabVIEW FPGA Module to develop custom, application-specific IP and meet the unique needs of your applications.

## Open Camera Connectivity

Unlike some vision component suppliers, NI Frame Grabbers and vision software allow you to choose the camera for your specific application. With support for USB3 Vision, GigE Vision, and Camera Link, you are sure to find the sensor that meets your application needs.



Figure 3. NI Frame Grabbers work with cameras that comply with USB3 Vision, GigE Vision, and Camera Link.

To find or submit cameras that have been tested with NI software or to download the camera support files to quickly start acquiring images, visit the [NI Camera Network](#).

## Synchronization Between Other Modules and Devices

Many systems that acquire images with frame grabbers often do more than just image acquisition. Frequently, systems combine image acquisition with motion control, data acquisition, or industrial communication. One of the challenges in integrating different processes is getting them to synchronize and work together. RTSI (Real-Time System Integration bus) is one of the keys to coordinating the motion control, image acquisition, and data acquisition. It is a dedicated high-speed digital bus designed to help systems integrate using low-level, high-speed real-time communication between NI devices. With RTSI, frame grabbers can share high-speed digital signals with data acquisition, motion control, or digital I/O devices without using external cabling and consuming bandwidth on the host bus. For PCI boards, the physical bus interface is an internal 34-pin connector, and signals are shared via a ribbon cable inside the PC enclosure. RTSI cables are available for chaining two, three, four, or five boards together. PXI modules require no cabling at all because the built-in PXI trigger bus handles RTSI functions.

# Vision Software

---

## Vision Builder for Automated Inspection

Vision Builder for Automated Inspection (AI) is a stand-alone configurable software environment that you can use to easily build, benchmark, and deploy applications for pattern matching, character recognition, presence detection, part classification, and more. Vision Builder AI offers an interactive menu-driven development environment that replaces the complexities of programming to make the development and maintenance process simple without sacrificing performance or range of functionality.

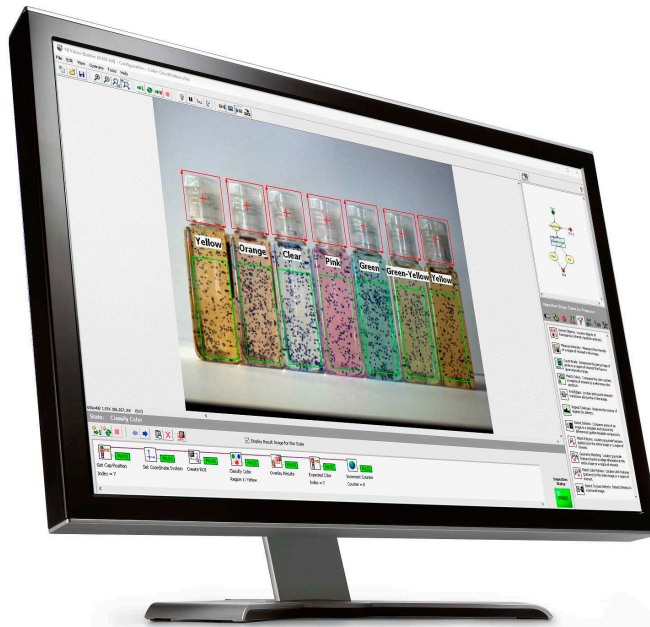

Figure 4. Simplify development with a sophisticated environment.

Vision Builder AI includes the following features:

**Faster Development and Deployment** – Vision Builder AI allows you to develop powerful machine vision applications. Using the menu-driven environment, you can focus on algorithm development instead of programming.

**Advanced Decision Making** – With the built-in State Diagram Editor, digital I/O, and industrial communications, you can deploy your Vision Builder AI application into the rest of your automated system.

**Fully Tested Toolchain** – The scalability of Vision Acquisition Software coupled with third-party camera support provides an open and fully tested infrastructure that saves time and money.

**Saved Development Time** – Use real data to develop your algorithms. Import or acquire test images directly into Vision Builder AI.

**Customizable Algorithms** – See the results of each function in your algorithm and tweak your algorithm each step of the way.

**Built-In Productivity Tools** – Develop algorithms faster with tools for template generation, OCR training, pattern matching, and more.



## Vision Development Module

The Vision Development Module offers hundreds of image processing algorithms and acquisition functions that you can use across the entire NI vision hardware portfolio to meet any vision application need. For more advanced imaging applications, the Vision Development Module is the ideal software package. With its comprehensive function library, you can access hundreds of image processing algorithms and machine vision functions to enhance images, check for presence, locate features, identify objects, measure parts, and more. The Vision Development Module offers the most flexibility and low-level function control for developing vision application solutions.



Figure 5. Build highly customized applications with systems in mind.

The Vision Development Module includes the following features:

**Build High-Performance Solutions** – Use hundreds of functions to develop high-performance vision algorithms to run on CPUs and FPGAs.

**Choose Your Programming Language** – Program your application in LabVIEW, LabWindows™/CVI, and C/C++.

**Design Complete Systems** – Expand your application beyond just vision. Incorporate motion control, I/O, and HMI in your design.

**Massive Parallelism** – FPGAs are parallel in nature, so they are ideally suited for vision applications. Parallelizing your algorithm decreases processing time, reduces latency, and increases overall throughput.

**Infinite Customizability** – FPGA-based image processing is implemented pixel by pixel, giving you the opportunity to customize your algorithm to meet your exact requirements.

**No FPGA Experience Needed** – You can develop high-performance FPGA-based vision algorithms the same way you do for a CPU-based design. You do not need to know traditional FPGA design tools.

## Vision Assistant

One of the challenges of developing software for machine vision applications is that vision algorithm development is, by its very nature, a repetitious process that requires multiple iterations of testing, adjusting function parameters, and retesting until the software satisfies the application requirements. This can be especially troublesome when using FPGAs for image processing because the traditional approach to FPGA development can slow down innovation due to the compilation times required between each design change of the algorithm. To address this challenge, the Vision Development Module includes a tool called the Vision Assistant.

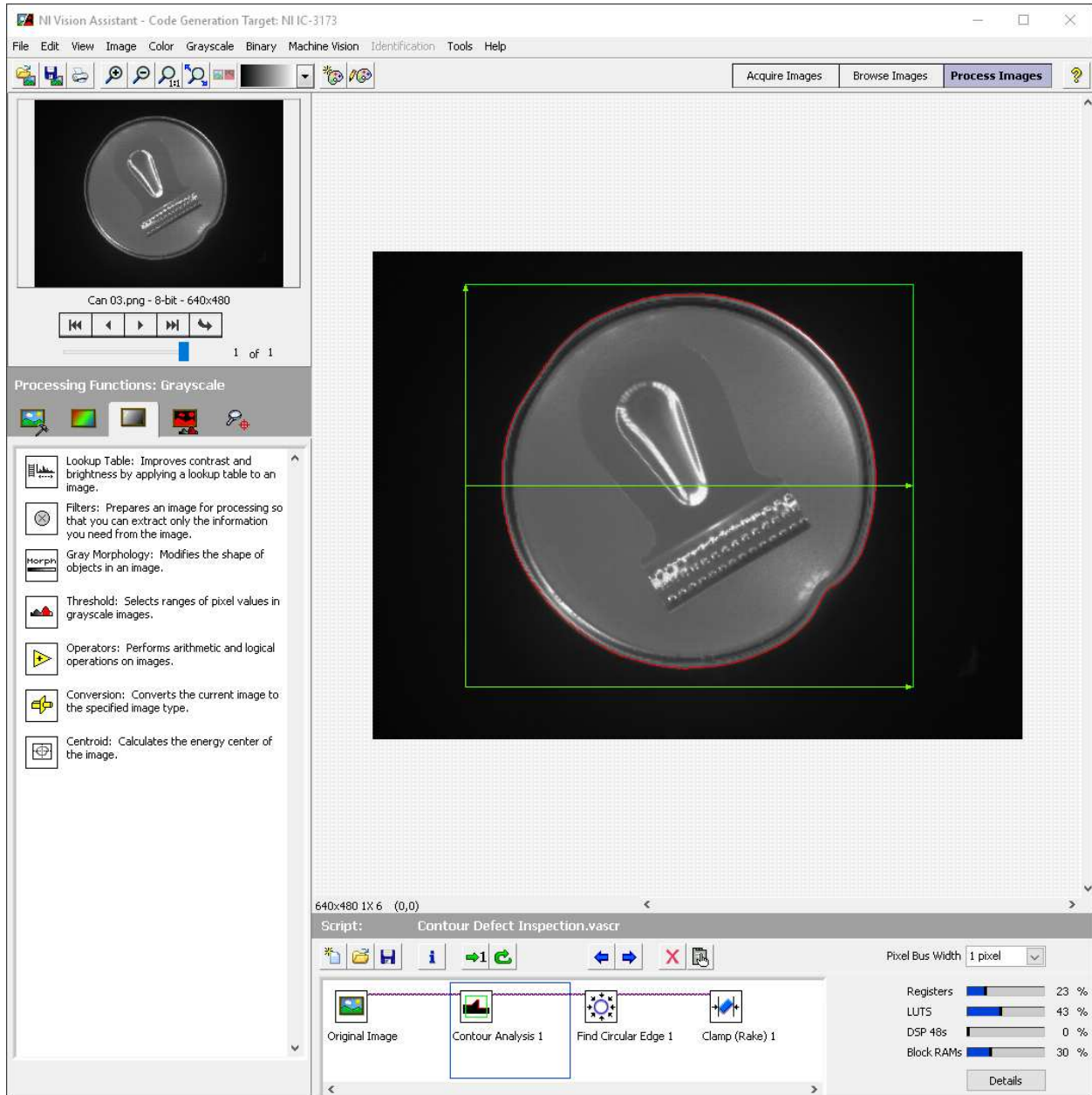

Figure 6. Developing an algorithm in a configuration-based tool for FPGA targets with integrated benchmarking cuts down on the time spent waiting for code to compile and accelerates development.

The Vision Assistant is an algorithm engineering tool that simplifies vision system design by helping you develop algorithms for deployment on either the CPU or FPGA. It provides a configuration-based approach to building vision algorithms like you can with Vision Builder AI. Load or acquire sample images and see the results of each processing step as it is configured to rapidly prototype your machine vision algorithm. It also provides the necessary benchmarking tools to gauge the performance of the algorithm. In addition, you can use the Vision Assistant to test the algorithm before compiling and running it on the target hardware while easily accessing throughput and resource utilization information.

Once you are satisfied with your algorithm, you can use the Vision Assistant to generate LabVIEW or C code ready for deployment on your choice of hardware controller. Then you can easily modify the generated code to integrate it with other parts of your system.

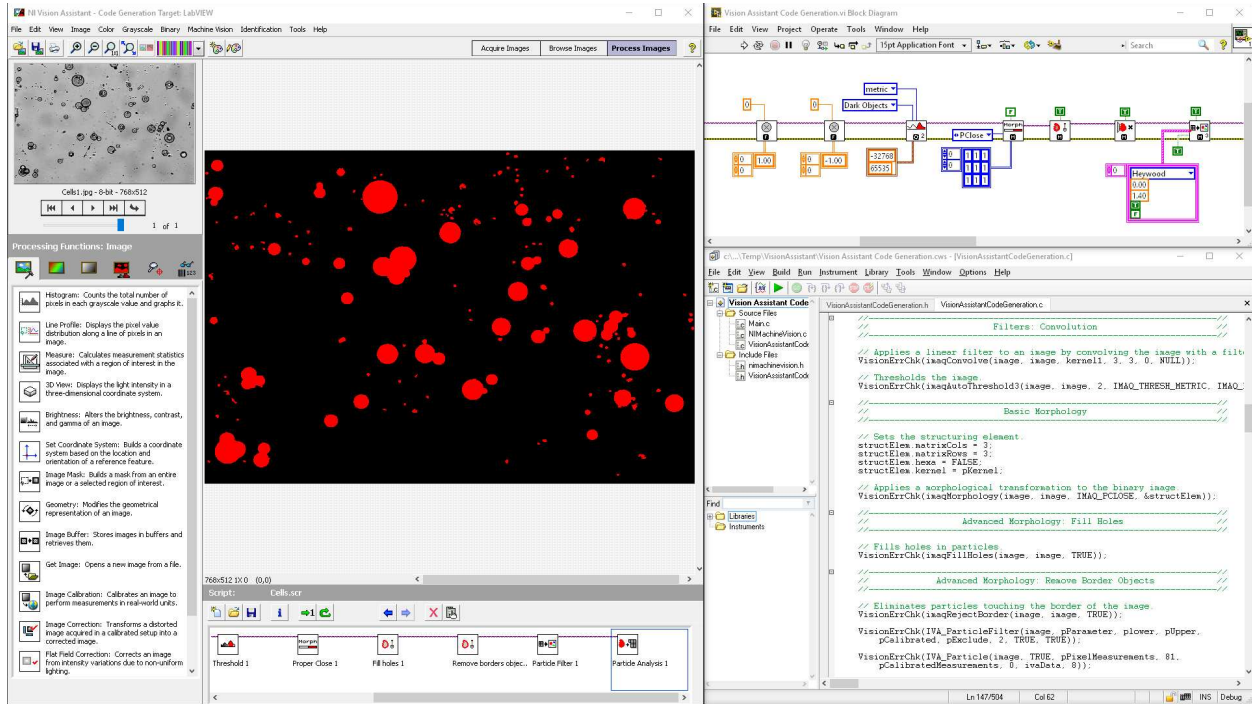
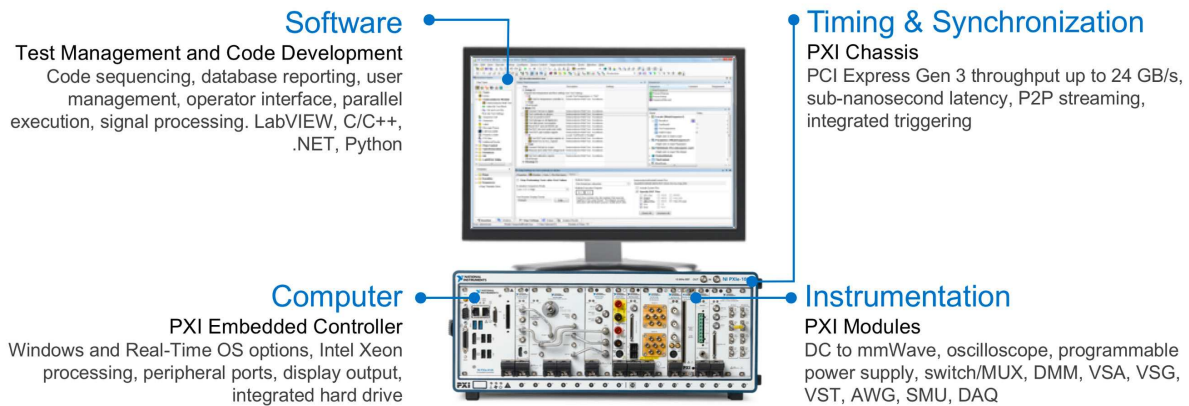

Figure 7. Use Vision Assistant to generate LabVIEW or C code.

# Platform-Based Approach to Test and Measurement





## What Is PXI?

Powered by software, PXI is a rugged PC-based platform for measurement and automation systems. PXI combines PCI electrical-bus features with the modular, Eurocard packaging of CompactPCI and then adds specialized synchronization buses and key software features. PXI is both a high-performance and low-cost deployment platform for applications such as manufacturing test, military and aerospace, machine monitoring, automotive, and industrial test. Developed in 1997 and launched in 1998, PXI is an open industry standard governed by the PXI Systems Alliance (PXISA), a group of more than 70 companies chartered to promote the PXI standard, ensure interoperability, and maintain the PXI specification.



## Integrating the Latest Commercial Technology

By leveraging the latest commercial technology for our products, we can continually deliver high-performance and high-quality products to our users at a competitive price. The latest PCI Express Gen 3 switches deliver higher data throughput, the latest Intel multicore processors facilitate faster and more efficient parallel (multisite) testing, the latest FPGAs from Xilinx help to push signal processing algorithms to the edge to accelerate measurements, and the latest data converters from TI and ADI continually increase the measurement range and performance of our instrumentation.

<p>HIGHER DATA THROUGHPUT</p>  <p>PCI Express Gen 3</p>	<p>PARALLEL TEST EXECUTION</p>  <p>Multicore Processors</p>	<p>MEASUREMENT ACCELERATION</p>  <p>FPGAs</p>	<p>INCREASED MEASUREMENT RANGE</p>  <p>Data Converters</p>
--	--	---	---

# Hardware Services

All NI hardware includes a one-year warranty for basic repair coverage, and calibration in adherence to NI specifications prior to shipment. PXI systems also include basic assembly and a functional test. NI offers additional entitlements to improve uptime and lower maintenance costs with service programs for hardware. Learn more at [ni.com/services/hardware](http://ni.com/services/hardware).

	Standard	Premium	Description
Program Duration	1, 3, or 5 years	1, 3, or 5 years	Length of service program
Extended Repair Coverage	•	•	NI restores your device's functionality and includes firmware updates and factory calibration.
System Configuration, Assembly, and Test <sup>1</sup>	•	•	NI technicians assemble, install software in, and test your system per your custom configuration prior to shipment.
Advanced Replacement <sup>2</sup>		•	NI stocks replacement hardware that can be shipped immediately if a repair is needed.
System Return Material Authorization (RMA) <sup>1</sup>		•	NI accepts the delivery of fully assembled systems when performing repair services.
Calibration Plan (Optional)	Standard	Expedited <sup>3</sup>	NI performs the requested level of calibration at the specified calibration interval for the duration of the service program.

<sup>1</sup>This option is only available for PXI, CompactRIO, and CompactDAQ systems.

<sup>2</sup>This option is not available for all products in all countries. Contact your local NI sales engineer to confirm availability.

<sup>3</sup>Expedited calibration only includes traceable levels.

## PremiumPlus Service Program

NI can customize the offerings listed above, or offer additional entitlements such as on-site calibration, custom sparring, and life-cycle services through a PremiumPlus Service Program. Contact your NI sales representative to learn more.

## Technical Support

Every NI system includes a 30-day trial for phone and e-mail support from NI engineers, which can be extended through a [Software Service Program \(SSP\)](#) membership. NI has more than 400 support engineers available around the globe to provide local support in more than 30 languages. Additionally, take advantage of NI's award winning [online resources](#) and [communities](#).

©2017 National Instruments. All rights reserved. LabVIEW, National Instruments, NI, NI TestStand, and ni.com are trademarks of National Instruments. Other product and company names listed are trademarks or trade names of their respective companies. The contents of this Site could contain technical inaccuracies, typographical errors or out-of-date information. Information may be updated or changed at any time, without notice. Visit [ni.com/manuals](http://ni.com/manuals) for the latest information.

2 January 2018