

COMPREHENSIVE SERVICES

We offer competitive repair and calibration services, as well as easily accessible documentation and free downloadable resources.

SELL YOUR SURPLUS

We buy new, used, decommissioned, and surplus parts from every NI series. We work out the best solution to suit your individual needs.

 Sell For Cash  Get Credit  Receive a Trade-In Deal

OBSOLETE NI HARDWARE IN STOCK & READY TO SHIP

We stock **New**, **New Surplus**, **Refurbished**, and **Reconditioned** NI Hardware.



Bridging the gap between the manufacturer and your legacy test system.

 1-800-915-6216

 www.apexwaves.com

 sales@apexwaves.com

All trademarks, brands, and brand names are the property of their respective owners.

Request a Quote

 **CLICK HERE**

PXI-1036

INSTALLATION GUIDE

Fan Replacement for 4–6 and 9 Slot Chassis

This guide describes how to replace the fan on a 4–6 and 9 slot PXI and PXI Express chassis.

Figure 1 shows the parts you must remove to access the fan. Refer to the following steps for installation and removal instructions.



Cautions Make sure to unplug the power cord before replacing the fan.

Only trained service personnel should replace the fan.

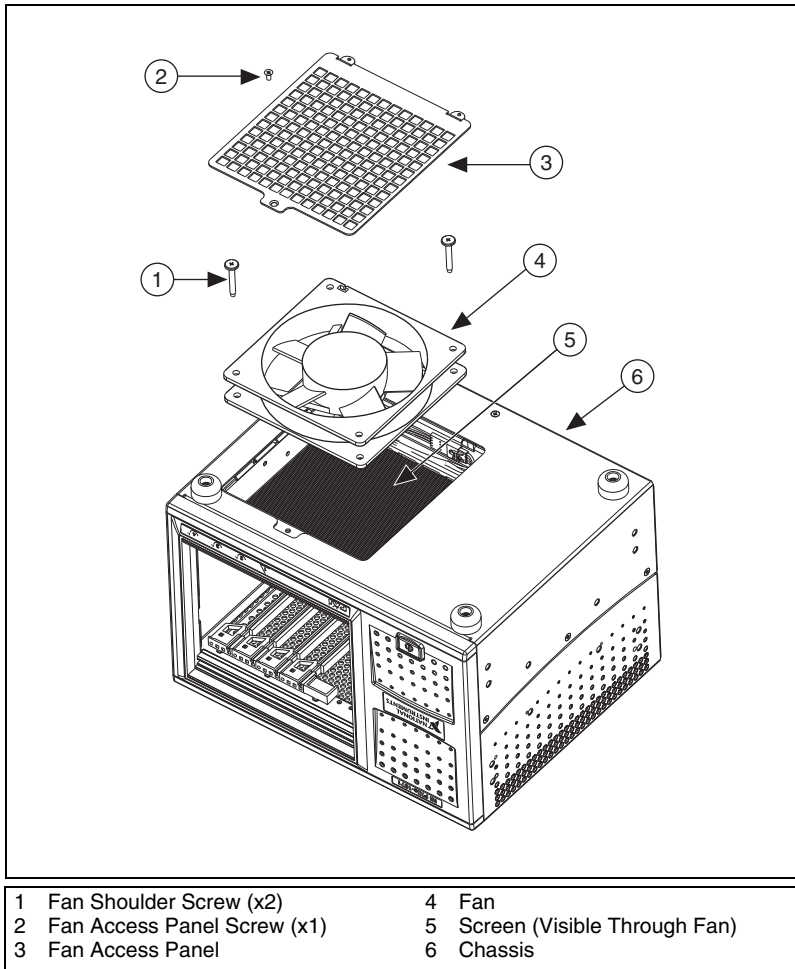

Figure 1. PXI Chassis Part Locations (Chassis Shown Upside Down)

Complete the following steps to replace the fan (refer to the previous figure for parts locations):

1. Locate the fan access panel on the bottom of the chassis. Remove the access panel screw and the access panel.
2. Remove the two fan shoulder screws, shown in Figure 1, that fasten the fan. Be careful not to lose the screws.
3. Remove the fan.

4. Disconnect the fan cable from the inline connector. The connector is shown in Figure 2.

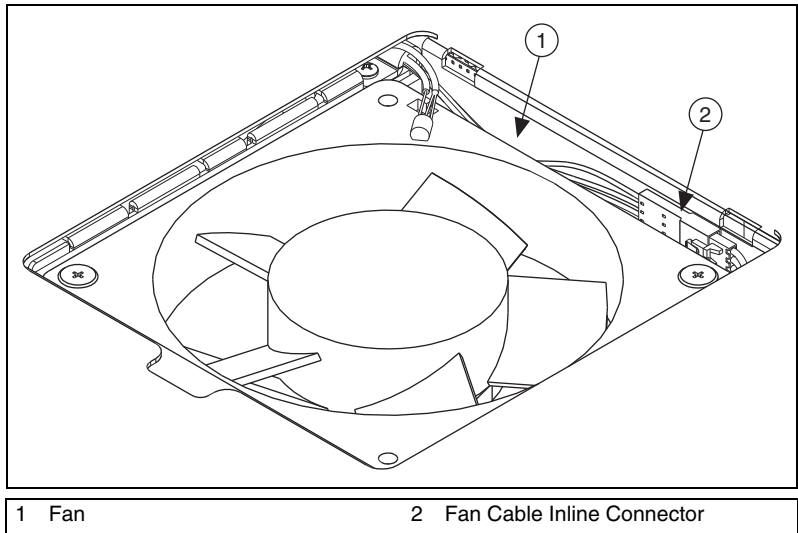
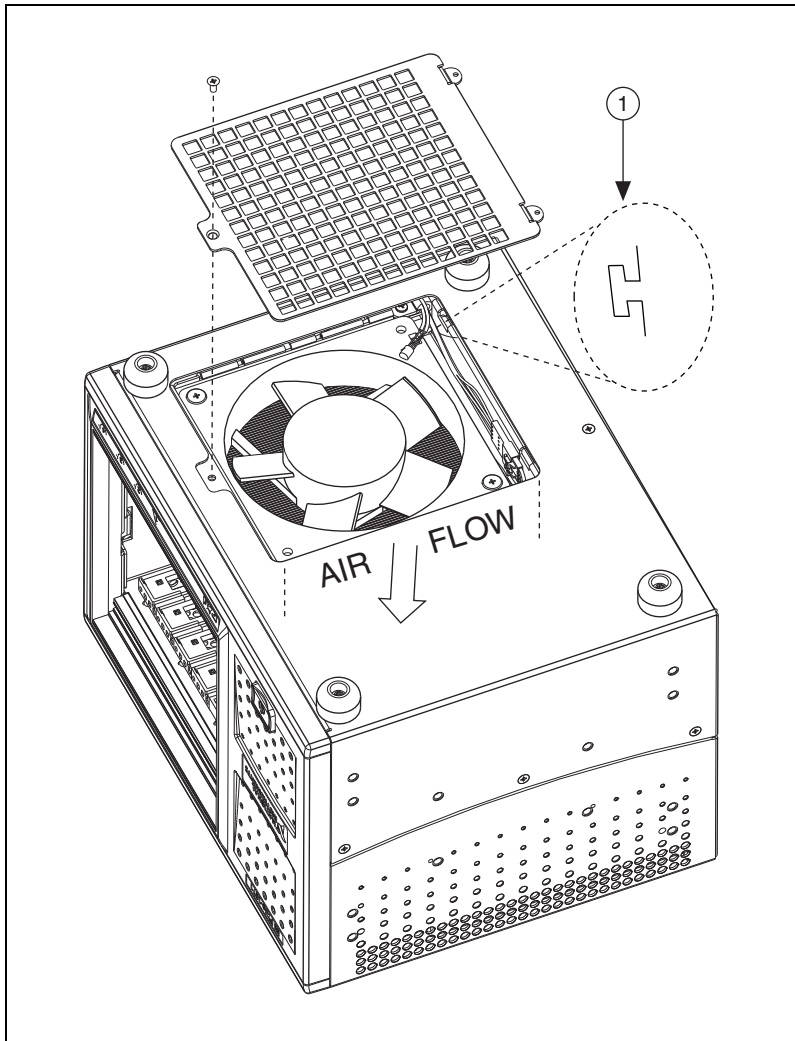

Figure 2. Fan Cable Inline Connector

5. Connect the new fan to the inline connector. Place the fan inside the fan bracket with the square slot oriented as shown in Figure 3. The air flow direction is into the chassis, so the plastic grill and label on the fan should face toward the PXI card cage.
Place the screen below the fan (see Figure 1 for screen location). Ensure that the loose screen doesn't fall out. If the screen does fall out, return it to its position under the fan.



1 Square Slot on Fan Housing

Figure 3. Square Slot on Fan Housing

6. Reinstall the two shoulder screws.

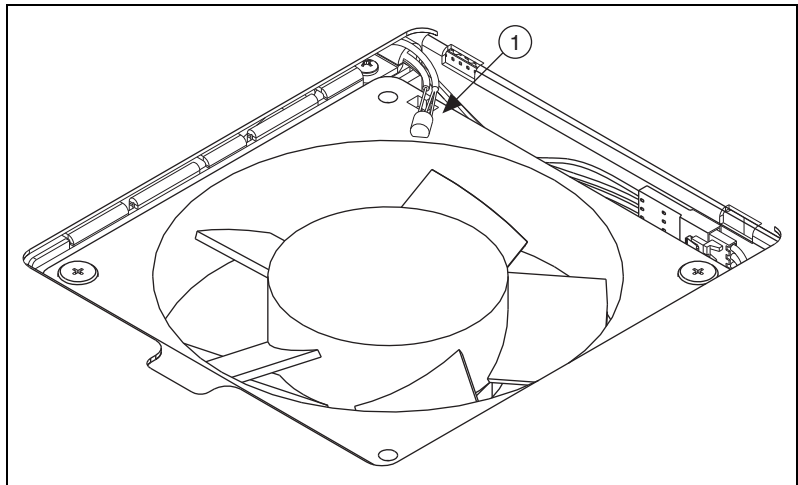

1 Thermistor wire

Figure 4. Thermistor Wire

7. Tighten the shoulder screws to between 3.0 lb · in minimum torque and 3.6 lb · in maximum torque.



Caution Orient the thermistor wire, as shown Figure 4, before replacing the fan access panel.

8. Place the fan access panel over the opening. Insert and tighten the access panel screw to between 3.0 lb · in minimum torque and 3.6 lb · in maximum torque.



Caution Reorient the chassis to an upright position and ensure there are no loose parts prior to plugging in the power cord.

LabVIEW, National Instruments, NI, ni.com, the National Instruments corporate logo, and the Eagle logo are trademarks of National Instruments Corporation. Refer to the *Trademark Information* at ni.com/trademarks for other National Instruments trademarks. Other product and company names mentioned herein are trademarks or trade names of their respective companies. For patents covering National Instruments products/technology, refer to the appropriate location: **Help»Patents** in your software, the `patents.txt` file on your media, or the *National Instruments Patent Notice* at ni.com/patents.