

COMPREHENSIVE SERVICES

We offer competitive repair and calibration services, as well as easily accessible documentation and free downloadable resources.

SELL YOUR SURPLUS

We buy new, used, decommissioned, and surplus parts from every NI series. We work out the best solution to suit your individual needs.

 Sell For Cash  Get Credit  Receive a Trade-In Deal

OBSOLETE NI HARDWARE IN STOCK & READY TO SHIP

We stock **New**, **New Surplus**, **Refurbished**, and **Reconditioned** NI Hardware.



Bridging the gap between the manufacturer and your legacy test system.

 1-800-915-6216

 www.apexwaves.com

 sales@apexwaves.com

All trademarks, brands, and brand names are the property of their respective owners.

Request a Quote

 **CLICK HERE**

PXI-1042

INSTALLATION GUIDE

NI PXI-8186

This document contains information about installing your NI PXI-8186 controller in a PXI chassis.

For complete configuration and troubleshooting information (including information about BIOS setup, adding RAM, and so on), refer to the *NI PXI-8186 User Manual*. The manual is in PDF format on the recovery CD included with your controller and on the National Instruments Web site, ni.com.

Installing the NI PXI-8186

This section contains general installation instructions for the NI PXI-8186. Consult your PXI chassis user manual for specific instructions and warnings.

1. Plug in your chassis before installing the NI PXI-8186. The power cord grounds the chassis and protects it from electrical damage while you install the module. (Make sure the power switch is turned off.)



Caution To protect both yourself and the chassis from electrical hazards, leave the chassis powered off until you finish installing the NI PXI-8186 module.

2. Remove any filler panels blocking access to the system controller slot (Slot 1) in the chassis.
3. Touch the metal part of the case to discharge any static electricity that might be on your clothes or body.
4. Remove the protective plastic covers from the four bracket-retaining screws as shown in Figure 1.

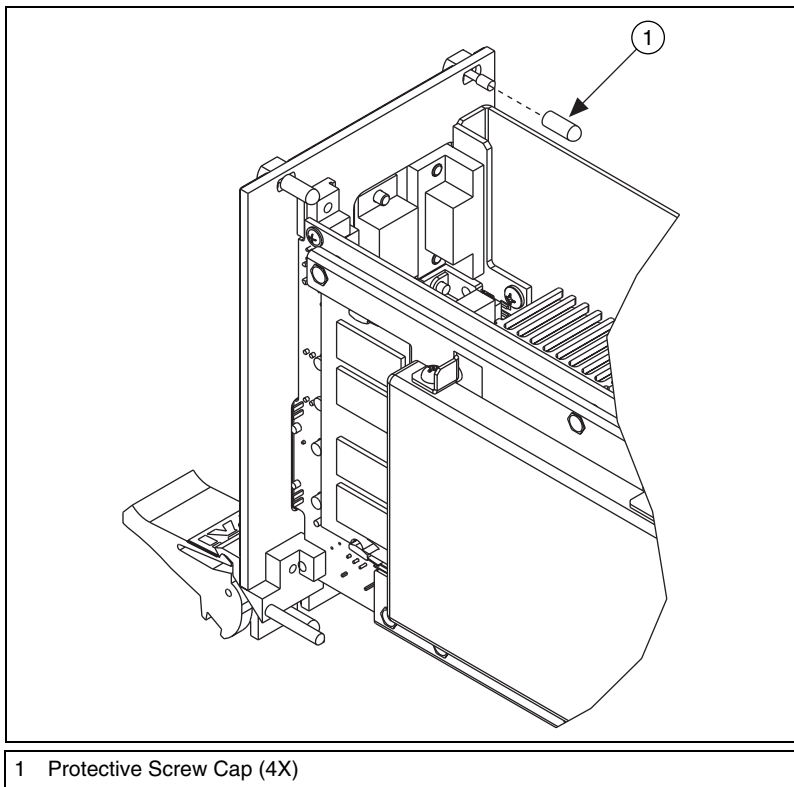

Figure 1. Removing Protective Screw Caps

5. Make sure the injector/ejector handle is in its downward position. Align the NI PXI-8186 with the card guides on the top and bottom of the system controller slot.



Caution Do *not* raise the injector/ejector handle as you insert the NI PXI-8186. The module will not insert properly unless the handle is in its downward position so that it does not interfere with the injector rail on the chassis.

6. Hold the handle as you slowly slide the module into the chassis until the handle catches on the injector/ejector rail.
7. Raise the injector/ejector handle until the module firmly seats into the backplane receptacle connectors. The front panel of the NI PXI-8186 should be even with the front panel of the chassis.
8. Tighten the four bracket-retaining screws on the top and bottom of the front panel to secure the NI PXI-8186 to the chassis.
9. Check the installation.

10. Connect the keyboard and mouse to the appropriate connectors. If you are using a PS/2 keyboard and a PS/2 mouse, use the Y-splitter adapter included with your controller to connect both to the PS/2 connector.
11. Connect the VGA monitor video cable to the VGA connector.
12. Connect devices to ports as required by your system configuration.
13. Power on the chassis.
14. Verify that the controller boots. If the controller does not boot, refer to the [What If the NI PXI-8186 Does Not Boot?](#) section.

Figure 2 shows an NI PXI-8186 installed in the system controller slot of a National Instruments PXI-1042 chassis. You can place PXI devices in any other slot.

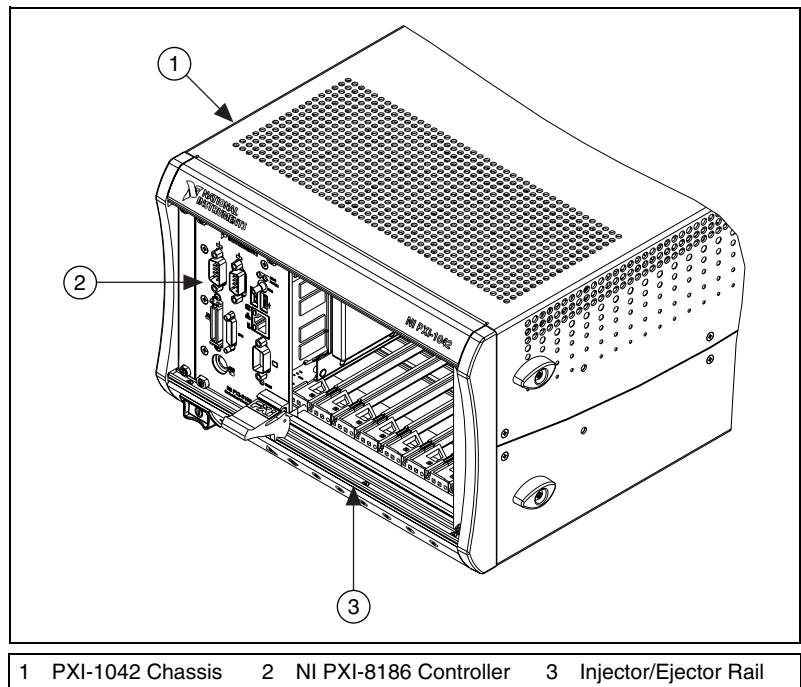

Figure 2. NI PXI-8186 Controller Installed in a PXI Chassis

How to Remove the Controller from the PXI Chassis

The NI PXI-8186 controller is designed for easy handling. To remove the unit from the PXI chassis:

1. Power off the chassis.
2. Remove the bracket-retaining screws in the front panel.
3. Press the injector/ejector handle down.
4. Slide the unit out of the chassis.

What If the NI PXI-8186 Does Not Boot?

Several problems can cause a controller not to boot. Here are some things to look for and possible solutions.

Things to Notice:

- Which LEDs come on? The **Power OK** LED should stay lit. The **Drive** LED should blink during boot as the disk is accessed.
- What appears on the display? Does it hang at some particular point (BIOS, Operating System, and so on)? If nothing appears on the screen, try a different monitor. Does your monitor work with a different PC? If it hangs, note the last screen output that you saw for reference when consulting National Instruments technical support.
- What has changed about the system? Did you recently move the system? Was there electrical storm activity? Did you recently add a new module, memory chip, or piece of software?

Things to Try:

- Make sure the chassis is plugged in to a working power source.
- Check any fuses or circuit breakers in the chassis or other power supply (possibly a UPS).
- Make sure the controller module is firmly seated in the chassis.
- Remove all other modules from the chassis.
- Remove any nonessential cables or devices.
- Try the controller in a different chassis.
- Try a similar controller in this same chassis.
- Recover the hard drive on the controller.
- Clear the CMOS.

