

COMPREHENSIVE SERVICES

We offer competitive repair and calibration services, as well as easily accessible documentation and free downloadable resources.

SELL YOUR SURPLUS

We buy new, used, decommissioned, and surplus parts from every NI series. We work out the best solution to suit your individual needs.

 Sell For Cash  Get Credit  Receive a Trade-In Deal

OBSOLETE NI HARDWARE IN STOCK & READY TO SHIP

We stock **New**, **New Surplus**, **Refurbished**, and **Reconditioned** NI Hardware.



Bridging the gap between the manufacturer and your legacy test system.

 1-800-915-6216

 www.apexwaves.com

 sales@apexwaves.com

All trademarks, brands, and brand names are the property of their respective owners.

Request a Quote

 **CLICK HERE**

PXI-1050

INSTALLATION GUIDE

NI PXI Slot Blocker

The NI PXI Slot Blocker improves system cooling in PXI chassis by re-routing airflow from empty slots to slots containing PXI modules. This guide describes how to most effectively use the NI PXI Slot Blocker.

What You Need to Get Started

- A PXI or PXI Express chassis recommended for use with the NI PXI Slot Blocker
- A PXI or PXI Express system controller
- PXI or PXI Express peripheral modules
- NI PXI slot blockers
- PXI filler panels

PXI Chassis Recommendations

Table 1 provides a list of NI PXI chassis recommended for use with the NI PXI Slot Blocker.

Table 1. NI PXI Chassis Recommended for Use with the NI PXI Slot Blocker

Chassis configuration	NI PXI Chassis	Recommendation
Chassis with fans in rear	NI PXI-104x Series NI PXI-1050 and NI PXI-1052 NI PXIe-106x Series	Highly Recommended
Chassis with fans below card cage	NI PXI-103x Series	Recommended
Chassis with dual-stacked modules	NI PXI-1056	Not Recommended

Installation

Complete the following steps to install the NI PXI Slot Blocker.

1. Install an NI PXI Slot Blocker in each empty slot of an NI PXI chassis, as shown in Figure 1.

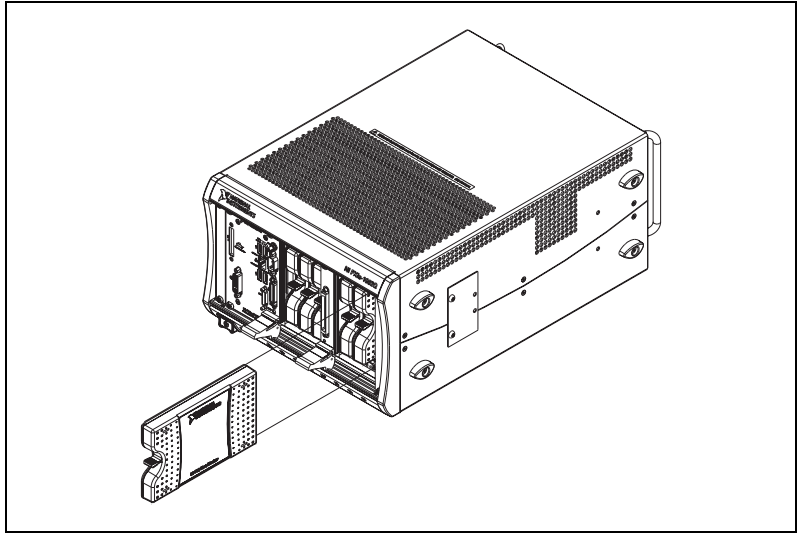

Figure 1. Installing the NI PXI Slot Blocker

Install filler panels over each slot containing an NI PXI Slot Blocker as shown in Figure 2.

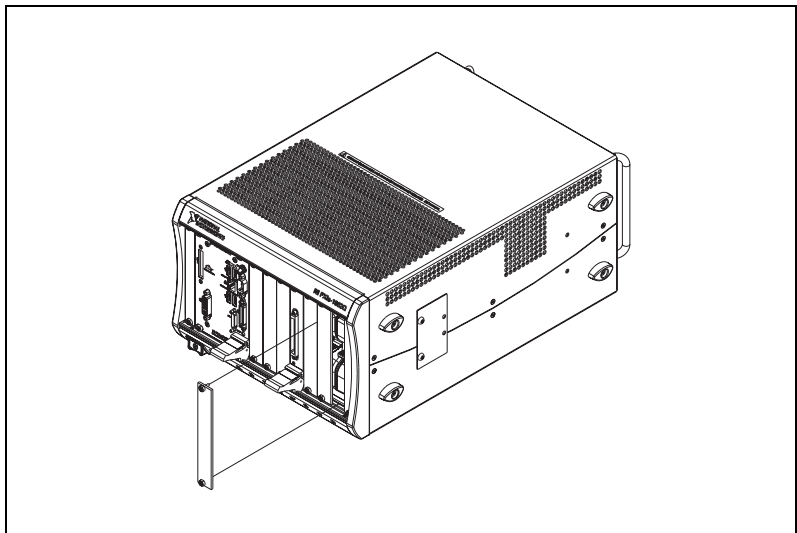

Figure 2. Installing a PXI filler panel

Ordering Information

The NI PXI Slot Blocker may be ordered from National Instruments using part number 199198-01. You may order through ni.com.

Where to Go for Support

The National Instruments Web site is your complete resource for technical support. At ni.com/support you have access to everything from troubleshooting and application development self-help resources to email and phone assistance from NI Application Engineers.

National Instruments corporate headquarters is located at 11500 North Mopac Expressway, Austin, Texas, 78759-3504. National Instruments also has offices located around the world to help address your support needs. For telephone support in the United States, create your service request at ni.com/support and follow the calling instructions or dial 512 795 8248. For telephone support outside the United States, contact your local branch office:

Australia 1800 300 800, Austria 43 662 457990-0,
Belgium 32 (0) 2 757 0020, Brazil 55 11 3262 3599,
Canada 800 433 3488, China 86 21 5050 9800,
Czech Republic 420 224 235 774, Denmark 45 45 76 26 00,
Finland 358 (0) 9 725 72511, France 01 57 66 24 24,
Germany 49 89 7413130, India 91 80 41190000, Israel 972 3 6393737,
Italy 39 02 41309277, Japan 0120-527196, Korea 82 02 3451 3400,
Lebanon 961 (0) 1 33 28 28, Malaysia 1800 887710,
Mexico 01 800 010 0793, Netherlands 31 (0) 348 433 466,
New Zealand 0800 553 322, Norway 47 (0) 66 90 76 60,
Poland 48 22 3390150, Portugal 351 210 311 210, Russia 7 495 783 6851,
Singapore 1800 226 5886, Slovenia 386 3 425 42 00,
South Africa 27 0 11 805 8197, Spain 34 91 640 0085,
Sweden 46 (0) 8 587 895 00, Switzerland 41 56 2005151,
Taiwan 886 02 2377 2222, Thailand 662 278 6777,
Turkey 90 212 279 3031, United Kingdom 44 (0) 1635 523545

National Instruments, NI, ni.com, and LabVIEW are trademarks of National Instruments Corporation. Refer to the *Terms of Use* section on ni.com/legal for more information about National Instruments trademarks. Other product and company names mentioned herein are trademarks or trade names of their respective companies. For patents covering National Instruments products, refer to the appropriate location: **Help»Patents** in your software, the `patents.txt` file on your media, or ni.com/patents.