

COMPREHENSIVE SERVICES

We offer competitive repair and calibration services, as well as easily accessible documentation and free downloadable resources.

SELL YOUR SURPLUS

We buy new, used, decommissioned, and surplus parts from every NI series. We work out the best solution to suit your individual needs.

 Sell For Cash  Get Credit  Receive a Trade-In Deal

OBSOLETE NI HARDWARE IN STOCK & READY TO SHIP

We stock **New**, **New Surplus**, **Refurbished**, and **Reconditioned** NI Hardware.



Bridging the gap between the manufacturer and your legacy test system.

 1-800-915-6216

 www.apexwaves.com

 sales@apexwaves.com

All trademarks, brands, and brand names are the property of their respective owners.

Request a Quote

 **CLICK HERE**

PXI-1409

IMAQ™

IMAQ PXI/PCI-1409 User Manual

*High-Quality Monochrome Image Acquisition Devices
for PXI, PCI, and CompactPCI Bus*

Worldwide Technical Support and Product Information

ni.com

National Instruments Corporate Headquarters

11500 North Mopac Expressway Austin, Texas 78759-3504 USA Tel: 512 683 0100

Worldwide Offices

Australia 1800 300 800, Austria 43 0 662 45 79 90 0, Belgium 32 0 2 757 00 20, Brazil 55 11 3262 3599,
Canada (Calgary) 403 274 9391, Canada (Montreal) 514 288 5722, Canada (Ottawa) 613 233 5949,
Canada (Québec) 514 694 8521, Canada (Toronto) 905 785 0085, Canada (Vancouver) 514 685 7530,
China 86 21 6555 7838, Czech Republic 420 2 2423 5774, Denmark 45 45 76 26 00,
Finland 385 0 9 725 725 11, France 33 0 1 48 14 24 24, Germany 49 0 89 741 31 30, Greece 30 2 10 42 96 427,
India 91 80 51190000, Israel 972 0 3 6393737, Italy 39 02 413091, Japan 81 3 5472 2970,
Korea 82 02 3451 3400, Malaysia 603 9131 0918, Mexico 001 800 010 0793, Netherlands 31 0 348 433 466,
New Zealand 1800 300 800, Norway 47 0 66 90 76 60, Poland 48 0 22 3390 150, Portugal 351 210 311 210,
Russia 7 095 238 7139, Singapore 65 6226 5886, Slovenia 386 3 425 4200, South Africa 27 0 11 805 8197,
Spain 34 91 640 0085, Sweden 46 0 8 587 895 00, Switzerland 41 56 200 51 51, Taiwan 886 2 2528 7227,
Thailand 662 992 7519, United Kingdom 44 0 1635 523545

For further support information, refer to the *Technical Support and Professional Services* appendix. To comment on the documentation, send email to techpubs@ni.com.

© 2000–2003 National Instruments Corporation. All rights reserved.

Important Information

Warranty

The IMAQ PXI-1409 and PCI-1409 are warranted against defects in materials and workmanship for a period of one year from the date of shipment, as evidenced by receipts or other documentation. National Instruments will, at its option, repair or replace equipment that proves to be defective during the warranty period. This warranty includes parts and labor.

The media on which you receive National Instruments software are warranted not to fail to execute programming instructions, due to defects in materials and workmanship, for a period of 90 days from date of shipment, as evidenced by receipts or other documentation. National Instruments will, at its option, repair or replace software media that do not execute programming instructions if National Instruments receives notice of such defects during the warranty period. National Instruments does not warrant that the operation of the software shall be uninterrupted or error free.

A Return Material Authorization (RMA) number must be obtained from the factory and clearly marked on the outside of the package before any equipment will be accepted for warranty work. National Instruments will pay the shipping costs of returning to the owner parts which are covered by warranty.

National Instruments believes that the information in this document is accurate. The document has been carefully reviewed for technical accuracy. In the event that technical or typographical errors exist, National Instruments reserves the right to make changes to subsequent editions of this document without prior notice to holders of this edition. The reader should consult National Instruments if errors are suspected. In no event shall National Instruments be liable for any damages arising out of or related to this document or the information contained in it.

EXCEPT AS SPECIFIED HEREIN, NATIONAL INSTRUMENTS MAKES NO WARRANTIES, EXPRESS OR IMPLIED, AND SPECIFICALLY DISCLAIMS ANY WARRANTY OF MERCHANTABILITY OR FITNESS FOR A PARTICULAR PURPOSE. CUSTOMER'S RIGHT TO RECOVER DAMAGES CAUSED BY FAULT OR NEGLIGENCE ON THE PART OF NATIONAL INSTRUMENTS SHALL BE LIMITED TO THE AMOUNT THEREOF PAID BY THE CUSTOMER. NATIONAL INSTRUMENTS WILL NOT BE LIABLE FOR DAMAGES RESULTING FROM LOSS OF DATA, PROFITS, USE OF PRODUCTS, OR INCIDENTAL OR CONSEQUENTIAL DAMAGES, EVEN IF ADVISED OF THE POSSIBILITY THEREOF. This limitation of the liability of National Instruments will apply regardless of the form of action, whether in contract or tort, including negligence. Any action against National Instruments must be brought within one year after the cause of action accrues. National Instruments shall not be liable for any delay in performance due to causes beyond its reasonable control. The warranty provided herein does not cover damages, defects, malfunctions, or service failures caused by owner's failure to follow the National Instruments installation, operation, or maintenance instructions; owner's modification of the product; owner's abuse, misuse, or negligent acts; and power failure or surges, fire, flood, accident, actions of third parties, or other events outside reasonable control.

Copyright

Under the copyright laws, this publication may not be reproduced or transmitted in any form, electronic or mechanical, including photocopying, recording, storing in an information retrieval system, or translating, in whole or in part, without the prior written consent of National Instruments Corporation.

Trademarks

CVI™, IMAQ™, LabVIEW™, Measurement Studio™, MITE™, National Instruments™, NI™, ni.com™, NI-DAQ™, NI-IMAQ™, and RTSI™ are trademarks of National Instruments Corporation.

Product and company names mentioned herein are trademarks or trade names of their respective companies.

Patents

For patents covering National Instruments products, refer to the appropriate location: **Help»Patents** in your software, the `patents.txt` file on your CD, or `ni.com/patents`.

WARNING REGARDING USE OF NATIONAL INSTRUMENTS PRODUCTS

(1) NATIONAL INSTRUMENTS PRODUCTS ARE NOT DESIGNED WITH COMPONENTS AND TESTING FOR A LEVEL OF RELIABILITY SUITABLE FOR USE IN OR IN CONNECTION WITH SURGICAL IMPLANTS OR AS CRITICAL COMPONENTS IN ANY LIFE SUPPORT SYSTEMS WHOSE FAILURE TO PERFORM CAN REASONABLY BE EXPECTED TO CAUSE SIGNIFICANT INJURY TO A HUMAN.

(2) IN ANY APPLICATION, INCLUDING THE ABOVE, RELIABILITY OF OPERATION OF THE SOFTWARE PRODUCTS CAN BE IMPAIRED BY ADVERSE FACTORS, INCLUDING BUT NOT LIMITED TO FLUCTUATIONS IN ELECTRICAL POWER SUPPLY, COMPUTER HARDWARE MALFUNCTIONS, COMPUTER OPERATING SYSTEM SOFTWARE FITNESS, FITNESS OF COMPILERS AND DEVELOPMENT SOFTWARE USED TO DEVELOP AN APPLICATION, INSTALLATION ERRORS, SOFTWARE AND HARDWARE COMPATIBILITY PROBLEMS, MALFUNCTIONS OR FAILURES OF ELECTRONIC MONITORING OR CONTROL DEVICES, TRANSIENT FAILURES OF ELECTRONIC SYSTEMS (HARDWARE AND/OR SOFTWARE), UNANTICIPATED USES OR MISUSES, OR ERRORS ON THE PART OF THE USER OR APPLICATIONS DESIGNER (ADVERSE FACTORS SUCH AS THESE ARE HEREAFTER COLLECTIVELY TERMED "SYSTEM FAILURES"). ANY APPLICATION WHERE A SYSTEM FAILURE WOULD CREATE A RISK OF HARM TO PROPERTY OR PERSONS (INCLUDING THE RISK OF BODILY INJURY AND DEATH) SHOULD NOT BE RELIANT SOLELY UPON ONE FORM OF ELECTRONIC SYSTEM DUE TO THE RISK OF SYSTEM FAILURE. TO AVOID DAMAGE, INJURY, OR DEATH, THE USER OR APPLICATION DESIGNER MUST TAKE REASONABLY PRUDENT STEPS TO PROTECT AGAINST SYSTEM FAILURES, INCLUDING BUT NOT LIMITED TO BACK-UP OR SHUT DOWN MECHANISMS. BECAUSE EACH END-USER SYSTEM IS CUSTOMIZED AND DIFFERS FROM NATIONAL INSTRUMENTS' TESTING PLATFORMS AND BECAUSE A USER OR APPLICATION DESIGNER MAY USE NATIONAL INSTRUMENTS PRODUCTS IN COMBINATION WITH OTHER PRODUCTS IN A MANNER NOT EVALUATED OR CONTEMPLATED BY NATIONAL INSTRUMENTS, THE USER OR APPLICATION DESIGNER IS ULTIMATELY RESPONSIBLE FOR VERIFYING AND VALIDATING THE SUITABILITY OF NATIONAL INSTRUMENTS PRODUCTS WHENEVER NATIONAL INSTRUMENTS PRODUCTS ARE INCORPORATED IN A SYSTEM OR APPLICATION, INCLUDING, WITHOUT LIMITATION, THE APPROPRIATE DESIGN, PROCESS AND SAFETY LEVEL OF SUCH SYSTEM OR APPLICATION.

Compliance

FCC/Canada Radio Frequency Interference Compliance

Determining FCC Class

The Federal Communications Commission (FCC) has rules to protect wireless communications from interference. The FCC places digital electronics into two classes. These classes are known as Class A (for use in industrial-commercial locations only) or Class B (for use in residential or commercial locations). All National Instruments (NI) products are FCC Class A products.

Depending on where it is operated, this Class A product could be subject to restrictions in the FCC rules. (In Canada, the Department of Communications (DOC), of Industry Canada, regulates wireless interference in much the same way.) Digital electronics emit weak signals during normal operation that can affect radio, television, or other wireless products.

All Class A products display a simple warning statement of one paragraph in length regarding interference and undesired operation. The FCC rules have restrictions regarding the locations where FCC Class A products can be operated.

Consult the FCC Web site at www.fcc.gov for more information.

FCC/DOC Warnings

This equipment generates and uses radio frequency energy and, if not installed and used in strict accordance with the instructions in this manual and the CE marking Declaration of Conformity*, may cause interference to radio and television reception. Classification requirements are the same for the Federal Communications Commission (FCC) and the Canadian Department of Communications (DOC).

Changes or modifications not expressly approved by NI could void the user's authority to operate the equipment under the FCC Rules.

Class A

Federal Communications Commission

This equipment has been tested and found to comply with the limits for a Class A digital device, pursuant to part 15 of the FCC Rules. These limits are designed to provide reasonable protection against harmful interference when the equipment is operated in a commercial environment. This equipment generates, uses, and can radiate radio frequency energy and, if not installed and used in accordance with the instruction manual, may cause harmful interference to radio communications. Operation of this equipment in a residential area is likely to cause harmful interference in which case the user is required to correct the interference at their own expense.

Canadian Department of Communications

This Class A digital apparatus meets all requirements of the Canadian Interference-Causing Equipment Regulations.

Cet appareil numérique de la classe A respecte toutes les exigences du Règlement sur le matériel brouilleur du Canada.

Compliance to EU Directives

Readers in the European Union (EU) must refer to the manufacturer's Declaration of Conformity (DoC) for information* pertaining to the CE marking compliance scheme. The manufacturer includes a DoC for most hardware products except for those bought from OEMs. In addition, DoCs are usually not provided if compliance is not required, for example electrically benign apparatus or cables.

To obtain the DoC for this product, click **Declarations of Conformity Information** at ni.com/hardref.nsf/. This Web site lists the DoCs by product family. Select the appropriate product family, followed by your product, and a link to the DoC appears in Adobe Acrobat format. Click the Acrobat icon to download or read the DoC.

* The CE marking Declaration of Conformity contains important supplementary information and instructions for the user or installer.

Conventions

The following conventions are used in this manual:

<>

Angle brackets that contain numbers separated by an ellipsis represent a range of values associated with a bit or signal name—for example, DIO<3..0>.

»

The » symbol leads you through nested menu items and dialog box options to a final action. The sequence **File»Page Setup»Options** directs you to pull down the **File** menu, select the **Page Setup** item, and select **Options** from the last dialog box.



This icon denotes a note, which alerts you to important information.



This icon denotes a caution, which advises you of precautions to take to avoid injury, data loss, or a system crash.

bold

Bold text denotes items that you must select or click in the software, such as menu items and dialog box options. Bold text also denotes parameter names.

italic

Italic text denotes variables, emphasis, a cross reference, or an introduction to a key concept. This font also denotes text that is a placeholder for a word or value that you must supply.

monospace

Text in this font denotes text or characters that you should enter from the keyboard, sections of code, programming examples, and syntax examples. This font is also used for the proper names of disk drives, paths, directories, programs, subprograms, subroutines, device names, functions, operations, variables, filenames and extensions, and code excerpts.

Contents

Chapter 1

Introduction

About the IMAQ 1409 Device.....	1-1
Using PXI with CompactPCI.....	1-2
Software Overview	1-3
NI-IMAQ Driver Software	1-3
National Instruments Application Software	1-4
Vision Builder for Automated Inspection	1-4
Vision Development Module	1-5
Integration with DAQ.....	1-5
Vision and Motion.....	1-6

Chapter 2

Installation

Necessary Items	2-1
Optional Equipment.....	2-2
Unpacking.....	2-2
Safety Information	2-3
Installation	2-5
PXI-1409	2-5
PCI-1409.....	2-6

Chapter 3

Hardware Overview

Functional Overview.....	3-1
Video Multiplexer	3-2
Programmable Gain and Offset.....	3-2
Analog Bandwidth Control Circuitry	3-2
10-Bit ADC	3-3
Digital Filter and LUT.....	3-3
Onboard Memory	3-3
Scatter-Gather DMA Controllers	3-3
PCI Interface.....	3-3
Genlock Circuit and SYNC Mux	3-3
Acquisition and Region-of-Interest (ROI) Control	3-4
RTSI Bus	3-4
Digital Input/Output Circuitry	3-4

Acquisition Modes.....	3-4
Analog Front End Considerations	3-5
10-Bit/8-Bit Mode.....	3-5
Clamping	3-6

Chapter 4

Signal Connections

BNC Connector	4-1
Digital I/O Connector	4-1
Digital I/O Connector Signal Connection Descriptions.....	4-3

Appendix A

Specifications

Appendix B

Custom Cables

Appendix C

Technical Support and Professional Services

Glossary

Index

Introduction

This chapter describes the PXI-1409 and PCI-1409 devices and your software programming choices.

About the IMAQ 1409 Device

The PXI-1409 and PCI-1409 devices are high-accuracy, monochrome image acquisition (IMAQ) devices for PXI, PCI, or CompactPCI chassis that support RS-170, CCIR, NTSC, and PAL video standards, as well as some nonstandard cameras from any of four input sources. The IMAQ 1409 features a 10-bit analog-to-digital converter (ADC) that converts video signals to digital formats. The IMAQ 1409 device acquires images in real time and stores them in onboard frame memory or transfers them directly to system memory.

The IMAQ 1409 is easy to install and configure. It ships with NI-IMAQ, the National Instruments complete image acquisition driver software you can use to directly control the IMAQ 1409 device and other National Instruments IMAQ devices. With NI-IMAQ, you can quickly and easily start your applications without having to program the device at the register level.

As a standalone device, the IMAQ 1409 device supports four general-purpose control lines that are configurable to generate precise timing signals for controlling camera acquisition. The IMAQ 1409 device also supports four video sources and four external I/O lines to use as triggers or digital I/O lines.

Easily synchronizing several functions to a common trigger or timing event is a common challenge with image acquisition devices. The IMAQ 1409 uses its Real-Time System Integration (RTSI) bus to solve this problem. The RTSI bus uses the National Instruments RTSI bus interface and ribbon cable to route additional timing and trigger signals between the IMAQ 1409 device and up to four National Instruments DAQ, Motion Control, or other IMAQ devices. The RTSI bus can even synchronize multiple IMAQ hardware captures.

For detailed PXI/PCI-1409 specifications, refer to Appendix A, *Specifications*.

Refer to Figure 1-1 for the location of the IMAQ 1409 W1 jumper and the connectors discussed in this manual.

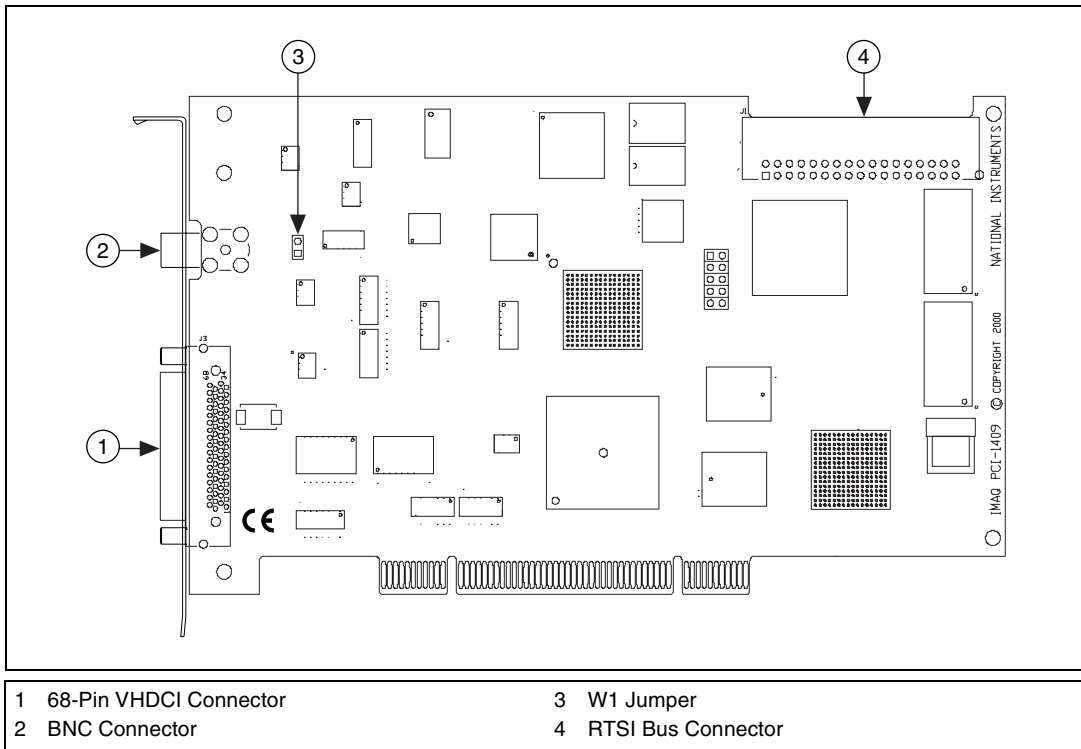

Figure 1-1. PCI-1409 Parts Locator Diagram

Using PXI with CompactPCI

Using PXI-compatible products with standard CompactPCI products is an important feature provided by the *PXI Specification*, Revision 1.0. If you use a PXI-compatible plug-in device in a standard CompactPCI chassis, you cannot use PXI-specific functions, but you can still use the basic plug-in device functions. For example, the RTSI bus on the PXI-1409 device is available in a PXI chassis, but not in a CompactPCI chassis.

The CompactPCI specification enables vendors to develop sub-buses that coexist with the basic PCI interface on the CompactPCI bus. Compatible operation is not guaranteed between CompactPCI devices with different

sub-buses or between CompactPCI devices with sub-buses and PXI. The standard implementation for CompactPCI does not include these sub-buses. The PXI-1409 device works in any standard CompactPCI chassis adhering to the *PICMG 2.0 R2.1 CompactPCI* core specification using the 64-bit definition for J2.

PXI-specific features are implemented on the J2 connector of the CompactPCI bus. Table 1-1 lists the J2 pins the PXI-1409 device uses. The PXI device is compatible with any CompactPCI chassis with a sub-bus that does not drive these lines.



Caution Even if the sub-bus is capable of driving these lines, the PXI device is still compatible as long as those pins on the sub-bus are disabled by default and are never enabled. Damage may result if these lines are driven by the sub-bus.

Table 1-1. Pins Used by the PXI-1409 Device

PXI-1409 Signal	PXI Pin Name	PXI J2 Pin Number
RTSI Trigger <0..6>	PXI Trigger <0..6>	B16, A16, A17, A18, B18, C18, E18

Software Overview

Programming the IMAQ 1409 device requires the NI-IMAQ driver software for controlling the hardware and one of the following application software packages for image processing:

- **Vision Builder for Automated Inspection (AI)**—for configuring solutions to common inspection tasks
- **National Instruments Vision Development Module**—for more customized control over hardware and algorithms

The following sections provide an overview of the driver software and the application software. For detailed information about individual software packages, refer to the documentation specific to the package.

NI-IMAQ Driver Software

The NI-IMAQ driver software ships with the IMAQ 1409 device. NI-IMAQ has an extensive library of functions you can call from your application programming environment, such as routines for video

configuration, image acquisition (continuous and single-shot), memory buffer allocation, trigger control, and device configuration.

NI-IMAQ performs all functions required for acquiring and saving images but does not perform image analysis. For image analysis functionality, refer to the *National Instruments Application Software* section of this chapter.

NI-IMAQ is also the interface path between LabVIEW, LabWindows™/CVI™, or a text-based programming environment and the IMAQ device. The NI-IMAQ software kit includes a series of libraries for image acquisition for LabVIEW, LabWindows/CVI, and Measurement Studio, which contains libraries for Visual Basic.

For maximum flexibility and performance, NI-IMAQ features both high-level and low-level functions. Examples of high-level functions include the sequences to acquire images in multi-buffer, single-shot, or continuous mode. An example of a low-level function is configuring an image sequence, since it requires advanced understanding of the IMAQ device and image acquisition.

NI-IMAQ handles many of the complex issues between the computer and the IMAQ device, such as programming interrupts and camera control.

National Instruments Application Software

Vision Builder for Automated Inspection

NI Vision Builder for Automated Inspection (AI) is configurable machine vision software that you can use to prototype, benchmark, and deploy applications. Vision Builder AI does not require programming, but is scalable to powerful programming environments.

Vision Builder AI allows you to easily configure and benchmark a sequence of visual inspection steps, as well as deploy the visual inspection system for automated inspection. With Vision Builder AI you can perform powerful visual inspection tasks and make decisions based on the results of individual tasks. With Vision Builder AI, you can migrate your configured inspection to LabVIEW, extending the capabilities of your applications if necessary.

Vision Builder AI is available for LabVIEW, LabWindows/CVI, and Measurement Studio, which includes support for Visual Basic.

Vision Development Module

The Vision Development Module is an image acquisition, processing, and analysis library of more than 270 functions for grayscale, color, and binary image display, image processing, pattern matching, particle analysis, gauging, and measurement.

For unique image processing, you can use the Vision Development Module functions individually or in combination. With the Vision Development Module you can acquire, display, manipulate, and store images, as well as perform image analysis, processing, and interpretation. Using the Vision Development Module, imaging novices and experts can program the most basic or complicated image applications without knowledge of particular algorithm implementations.

NI Vision Assistant is included with the Vision Development Module. Vision Assistant is an interactive prototyping tool for machine vision and scientific imaging developers. With Vision Assistant, you can prototype vision applications quickly and test how various vision image processing functions work.

Vision Assistant generates a builder file, which is a text description containing a recipe of the machine vision and image processing functions. This builder file provides a guide you can use for developing applications into any development environment, such as LabWindows/CVI or Visual Basic, using the Vision Assistant machine vision and image processing libraries. Using the LabVIEW VI creation wizard, Vision Assistant can create LabVIEW VI diagrams that perform the prototype you created in Vision Assistant. Using LabVIEW, you can add functionality to this generated VI.

Integration with DAQ

Platforms that support NI-IMAQ also support NI-DAQ and a variety of National Instruments DAQ boards. This allows integration between IMAQ devices and National Instruments DAQ products.

Vision and Motion

With National Instruments IMAQ hardware and Vision Assistant pattern matching software, you can quickly and accurately locate objects that vary in size, orientation, focus, and illumination. Use National Instruments high-performance stepper and servo motion control products with pattern matching software in inspection and guidance applications, such as locating alignment markers on semiconductor wafers, guiding robotic arms, inspecting the quality of manufactured parts, and locating cells.

Installation

This chapter contains information about getting started with the IMAQ 1409 device.

Necessary Items

The following items are necessary for setting up and configuring the IMAQ 1409 device:

- PXI/PCI-1409 device
- NI-IMAQ driver software and documentation
- Getting Started with Your IMAQ System*
- NI-IMAQ for Windows 2000/NT/XP/Me/98
- Optional software packages and documentation:
 - NI Vision Builder for Automated Inspection
 - NI Vision Assistant
 - LabVIEW
 - LabWindows/CVI
 - Measurement Studio
- IMAQ BNC-1 shielded, 75 Ω BNC cable for VIDEO0, included with the IMAQ 1409
- BNC to RCA adapter, included with the IMAQ 1409
- A video camera or other video source
- Pentium-based PXI, PCI, or CompactPCI computer running Windows 2000, Windows NT, Windows XP, Windows Me, or Windows 98



Note The IMAQ 1409 devices rely on the computer's PCI interface chipset for the highest throughput to system memory. For the best results, the computer should have a Pentium or faster processor and an Intel 430 or 440 series or compatible PCI interface chipset.

Optional Equipment

National Instruments offers the following products for use with the IMAQ 1409 device:

- IMAQ 6822 BNC breakout box and cable for trigger and additional camera support
- RTSI bus cables for connecting the IMAQ 1409 device to DAQ, Motion Control, and IMAQ hardware
- Other National Instruments DAQ devices for enhanced triggering, timing, or input/output

For specific information about these products, refer to the National Instruments catalog, visit ni.com, or call the office nearest you.

Unpacking

The IMAQ 1409 device ships in an antistatic package to prevent electrostatic discharge from damaging device components. To avoid such damage in handling the device, take the following precautions:

- Ground yourself via a grounding strap or by holding a grounded object, such as your computer chassis.
- Touch the antistatic package to a metal part of your computer chassis before removing the device from the package.



Caution *Never* touch the exposed pins of connectors.

- Remove the device from the package and inspect it for loose components or any other signs of damage. Notify National Instruments if the device appears damaged in any way. Do *not* install a damaged device in your computer.

Safety Information



Caution The following paragraphs contain important safety information you *must* follow when installing and operating the device.

Do *not* operate the device in a manner not specified in the documentation. Misuse of the device may result in a hazard and may compromise the safety protection built into the device. If the device is damaged, turn it off and do *not* use it until service-trained personnel can check its safety. If necessary, return the device to National Instruments for repair.

Keep away from live circuits. Do *not* remove equipment covers or shields unless you are trained to do so. If signal wires are connected to the device, hazardous voltages can exist even when the equipment is turned off. To avoid a shock hazard, do *not* perform procedures involving cover or shield removal unless you are qualified to do so. Disconnect all field power prior to removing covers or shields.

If the device is rated for use with hazardous voltages ($>30 V_{\text{rms}}$, $42.4 V_{\text{pk}}$, or $60 V_{\text{dc}}$), it may require a safety earth-ground connection wire. Refer to the device specifications for maximum voltage ratings.

Because of the danger of introducing additional hazards, do *not* install unauthorized parts or modify the device. Use the device only with the chassis, modules, accessories, and cables specified in the installation instructions. All covers and filler panels *must* be installed while operating the device.

Do *not* operate the device in an explosive atmosphere or where flammable gases or fumes may be present. Operate the device only at or below the pollution degree stated in the specifications. Pollution consists of any foreign matter—solid, liquid, or gas—that may reduce dielectric strength or surface resistivity. Pollution degrees are listed below.

- Pollution Degree 1—No pollution or only dry, nonconductive pollution occurs. The pollution has no effect.
- Pollution Degree 2—Normally only nonconductive pollution occurs. Occasionally, nonconductive pollution becomes conductive because of condensation.
- Pollution Degree 3—Conductive pollution or dry, nonconductive pollution occurs. Nonconductive pollution becomes conductive because of condensation.

Clean the device and accessories by brushing off light dust with a soft, nonmetallic brush. Remove other contaminants with a stiff, nonmetallic brush. The unit *must* be completely dry and free from contaminants before returning it to service.

You *must* insulate signal connections for the maximum voltage for which the device is rated. Do *not* exceed the maximum ratings for the device. Remove power from signal lines before connection to or disconnection from the device.



Caution National Instruments measurement products may be classified as either Installation Category I or II. Operate products at or below the Installation Category level specified in the hardware specifications.

Installation Category¹: Measurement circuits are subjected to working voltages² and transient stresses (overvoltage) from the circuit to which they are connected during measurement or test. Installation Category establishes standardized impulse withstand voltage levels that commonly occur in electrical distribution systems. The following is a description of Installation (Measurement³) Categories:

- Installation Category I is for measurements performed on circuits *not* directly connected to the electrical distribution system referred to as MAINS⁴ voltage. This category is for measurements of voltages from specially protected secondary circuits. Such voltage measurements include signal levels, special equipment, limited-energy parts of equipment, circuits powered by regulated low-voltage sources, and electronics.
- Installation Category II is for measurements performed on circuits directly connected to the electrical distribution system. This category refers to local-level electrical distribution, such as that provided by a standard wall outlet (e.g., 115 V for U.S. or 230 V for Europe). Examples of Installation Category II are measurements performed on household appliances, portable tools, and similar products.
- Installation Category III is for measurements performed in the building installation at the distribution level. This category refers to measurements on hard-wired equipment such as equipment in fixed

¹ Installation Categories as defined in electrical safety standard IEC 61010-1.

² Working voltage is the highest rms value of an AC or DC voltage that can occur across any particular insulation.

³ Installation Category is also referred to as Measurement Category.

⁴ MAINS is defined as the (hazardous live) electrical supply system to which equipment is designed to be connected for the purpose of powering the equipment. Suitably rated measuring circuits may be connected to the MAINS for measuring purposes.

installations, distribution boards, and circuit breakers. Other examples are wiring, including cables, bus-bars, junction boxes, switches, socket-outlets in the fixed installation, and stationary motors with permanent connections to fixed installations.

- Installation Category IV is for measurements performed at the primary electrical supply installation (<1,000V). Examples include electricity meters and measurements on primary overcurrent protection devices and on ripple control units.

Installation

Before getting started, refer to the electrostatic discharge guidelines in the [Unpacking](#) section of this chapter.

PXI-1409

You can install a PXI-1409 in any available 5 V peripheral slot in your PXI or CompactPCI chassis.



Note The PXI-1409 has connections to several reserved lines on the CompactPCI J2 connector. Before installing a PXI-1409 in a CompactPCI system that uses J2 connector lines for purposes other than PXI, refer to the [Using PXI with CompactPCI](#) section of Chapter 1, [Installation](#).

1. Power off and unplug the PXI or CompactPCI chassis.
2. Verify that the W1 jumper is intact. The PXI-1409 device ships with this jumper intact.
3. Choose an unused PXI or CompactPCI 5 V peripheral slot that supports bus arbitration or bus-master cards. PXI-compliant chassis must have bus arbitration for all slots.
4. Remove the filler panel for the peripheral slot you have chosen.
5. Touch a metal part on the chassis to discharge any static electricity that might be on your clothes or body.
6. Insert the PXI-1409 in the selected 5 V slot. Use the injector/ejector handle to fully inject the device into place.
7. Screw the front panel of the PXI-1409 to the front panel mounting rails of the PXI or CompactPCI chassis.
8. Visually verify the installation.
9. Plug in and power on the PXI or CompactPCI chassis.



Note You *must* install the NI-IMAQ driver software before installing the IMAQ 1409 device.

PCI-1409

Install the PCI-1409 in any available PCI expansion slot in your computer. To achieve the best noise performance, leave as much room as possible between the PCI-1409 and other boards and hardware.

Complete the following instructions to install the PCI-1409.

1. Verify that the NI-IMAQ driver software is installed on your computer.
2. Verify that the W1 jumper is intact. The PCI-1409 device ships with this jumper intact.
3. Power off and unplug your computer.



Caution To protect both yourself and the computer from electrical hazards, the computer should remain off and unplugged until you finish installing the 1409 device.

4. Remove the computer cover. Make sure there are no lit LEDs on the motherboard. If any are lit, wait until they go out before continuing installation.
5. Touch the metal part of the power supply case inside the computer to discharge any static electricity that might be on your clothes or body.
6. Locate the metal bracket that covers the cut-out in the back panel of the chassis for the slot you have selected. Remove and save the bracket-retaining screw and the bracket cover.
7. Line up the PCI-1409 card-edge connector with the expansion slot receptacle. Using slow, evenly distributed pressure, press the PCI-1409 straight down until it seats in the expansion slot.
8. Reinstall the bracket-retaining screw to secure the PCI-1409 to the back panel rail.
9. Visually verify the installation.
10. Replace the computer cover, and plug the computer in.

Hardware Overview

This chapter describes the features of the IMAQ 1409 device and includes information about acquisition modes, analog front-end considerations, and clamping.

Functional Overview

The IMAQ 1409 features a flexible, high-speed data path optimized for the acquisition and formatting of video data from analog cameras. The IMAQ 1409 device can acquire from RS-170/NTSC, CCIR/PAL, VGA, and progressive scan cameras, as well as from non-standard cameras such as line scan cameras. The IMAQ 1409 device digitizes analog video signals to 8 or 10 bits of resolution at sampling frequencies up to 40 MHz.

The IMAQ 1409 has a factory-calibrated gain circuit to improve measurement accuracy and board-to-board consistency. It uses a PCI interface for high-speed data transfer, 16 MB of SDRAM for data buffering, and region-of-interest control circuitry for optimizing the data transfer. The 16 MB of SDRAM also allows you to acquire entire images into onboard memory when necessary. The IMAQ 1409 includes four external triggers, four camera control signals, seven RTSI bus triggers, and six video synchronization signals.

The block diagram in Figure 3-1 illustrates the key functional units of the PXI/PCI-1409.

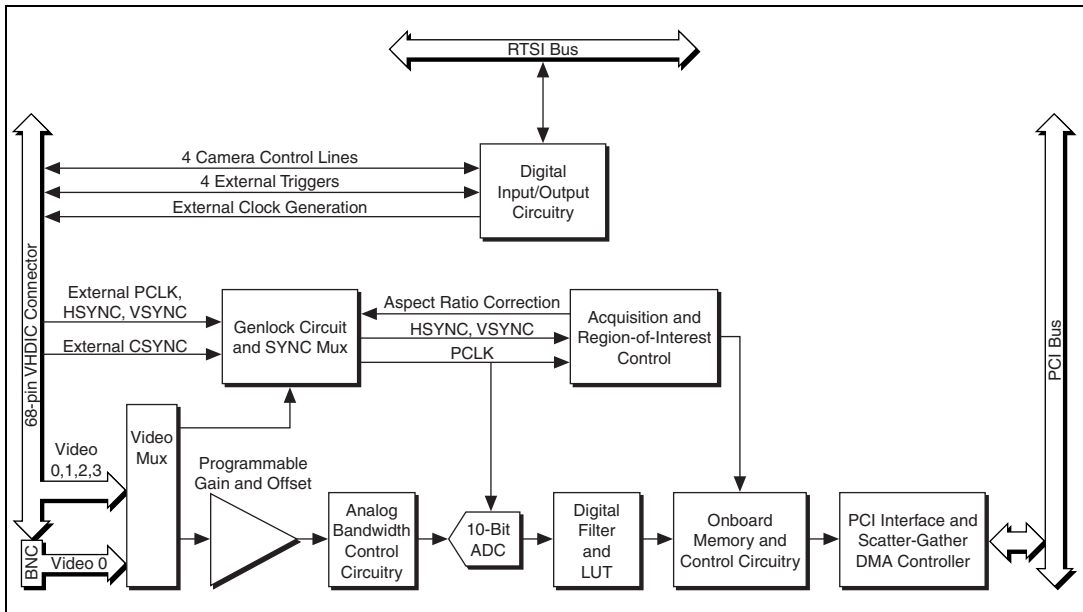

Figure 3-1. IMAQ 1409 Block Diagram

Video Multiplexer

The video multiplexer routes one of the four AC-coupled video inputs to the 10-bit ADC circuitry. The input impedance at the input to the board is 75 Ω .

Programmable Gain and Offset

The IMAQ 1409 uses programmable gain and offset circuitry to optimize the input signal range.

Analog Bandwidth Control Circuitry

You can select either the full bandwidth of 30 MHz or a reduced bandwidth of 9 MHz. The 9 MHz bandwidth setting is available using a 5th order Butterworth lowpass filter.

10-Bit ADC

The 10-bit ADC digitizes the conditioned video signal.

Digital Filter and LUT

The digital filter removes chrominance from a composite color video signal that conforms to either PAL or NTSC. The output of the digital filter passes through the $1,024 \times 10$ -bit lookup table (LUT). You can configure the LUT to implement simple imaging operations such as contrast enhancement, data inversion, gamma correction, or other user-defined transfer functions.

Onboard Memory

The IMAQ 1409 has 16 MB of SDRAM for temporarily storing image data being transferred to the system memory through the PCI bus. The memory can store multiple image buffers.

Scatter-Gather DMA Controllers

The IMAQ 1409 uses three independent onboard direct memory access (DMA) controllers. The DMA controllers transfer data between the onboard SDRAM memory buffer and the PCI bus. Each of these controllers supports scatter-gather DMA, which allows the controllers to reconfigure on the fly. This functionality enables the IMAQ 1409 to perform continuous image transfers directly to either contiguous or fragmented memory buffers.

PCI Interface

The PCI-1409 implements the PCI interface with a National Instruments custom application-specific integrated circuit (ASIC), the PCI MITE. The PCI interface can transfer data at a maximum rate of 132 MB/s in bus master mode.

Genlock Circuit and SYNC Mux

The genlock circuit receives the incoming video signal and generates PCLK, HSYNC, and VSYNC signals for use by the acquisition and control circuitry. The IMAQ 1409 device can lock to the standard RS-170/NTSC and CCIR/PAL video signals as well as progressive scan and VGA (640 \times 480 resolution) signals. The genlock circuit on the IMAQ 1409 device can also lock to external HSYNC and VSYNC or CSYNC signals.

Acquisition and Region-of-Interest (ROI) Control

The acquisition and region-of-interest control circuitry routes the active pixels from the 10-bit ADC to the onboard memory. The IMAQ 1409 can perform ROI and scaling on all video lines. Pixel and line scaling transfers certain multiples (two, four, or eight) of pixels and lines to onboard memory.

RTSI Bus

The seven trigger lines on the RTSI bus provide a flexible interconnection scheme between multiple IMAQ devices, as well as between National Instruments DAQ or Motion Control devices.

Digital Input/Output Circuitry

The digital input/output (I/O) circuitry routes, monitors, and drives the external trigger lines, RTSI bus lines, and camera control lines. You can use the trigger lines to start or stop an acquisition on a rising or falling edge. You also can map onboard signals such as HSYNC, VSYNC, ACQUISITION_IN_PROGRESS, and ACQUISITION_DONE to these lines. The camera control lines provide a means to generate deterministic signals for triggering cameras, strobe lights, or other timing-critical applications. This module also contains an external clock generation circuit you can use as the source clock for a line scan camera.



Note The IMAQ 1409 device does not support pixel clock output on the trigger lines.

Acquisition Modes

The IMAQ 1409 supports the following five video acquisition modes:

- **Standard Mode**—In standard mode, the IMAQ 1409 receives an incoming composite video signal from the external BNC or 68-pin VHDCI connector and generates CSYNC, HSYNC, VSYNC, and PCLK signals. The VHDCI connector outputs the generated CSYNC signal to synchronize other IMAQ devices or cameras.
- **CSYNC External Mode**—In CYSNC external mode, the IMAQ 1409 receives an incoming video signal (composite or luminance) and an external CSYNC signal from the external connector and generates HSYNC, VSYNC, and PCLK signals.

- **External Lock Mode**—In external lock mode, the IMAQ 1409 device receives HSYNC, VSYNC, and PCLK signals from the camera and uses these signals to acquire the video signals directly. You can use this mode to acquire from a line scan camera.
- **External HSYNC/VSYNC Mode**—In external HSYNC/VSYNC mode, the IMAQ 1409 device receives the external HSYNC and VSYNC from the connector and internally generates the PCLK signal. The IMAQ 1409 genlock circuitry locks to the external HSYNC and VSYNC signals. You can use this mode to acquire from VGA monitors (640 × 480 resolution).
- **External HSYNC/VSYNC (HLOCK only) Mode**—In external HSYNC/VSYNC (HLOCK only) mode, the IMAQ 1409 device receives the external HSYNC and VSYNC signals and internally generates the PCLK signal. In this mode, the IMAQ 1409 genlock circuitry uses only the HSYNC signal for locking. You can use this mode to acquire from asynchronously reset cameras that output a continuous HSYNC.

Analog Front End Considerations

The analog front end of the IMAQ 1409 device features a calibrated gain circuit, programmable DC-restore circuit, and 10-bit ADC as shown in Figure 3-2.

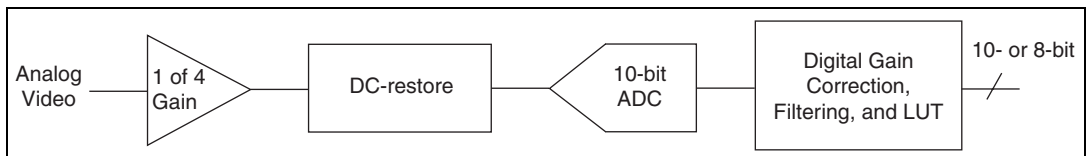

Figure 3-2. IMAQ 1409 Analog Front End

10-Bit/8-Bit Mode

The IMAQ 1409 always digitizes the incoming video signal to 10 bits of resolution. In 10-bit mode, the IMAQ 1409 has four fixed, full-scale ranges for calibrating the gain for each range. Because the nominal full-scale ranges are 0.20, 0.35, 0.70, and 1.40 V, the gain is not continuously variable in this mode. To maintain compatibility with other IMAQ analog devices, the IMAQ 1409 has an 8-bit mode that converts the 10-bit data from the ADC to 8-bit data in the lookup table (LUT) after gain correction and any digital filtering has occurred.

Clamping

The NTSC camera file sets the default values of Clamp Start and Clamp Stop to 106 and 116, respectively. These settings place the clamp pulse, which restores the DC level of the video signal, between the color burst signal and the beginning of active video. Because some cameras deviate from the exact timing required by the NTSC standard, the clamping pulse may intersect either the color burst or the active video portions of the signal. If this occurs, an acquired image may appear to have dark and light bands, as in the following image:

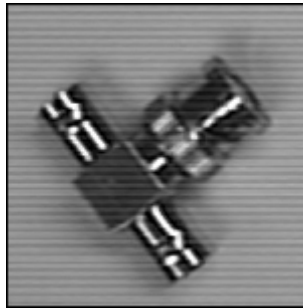

To prevent this problem, open Measurement & Automation Explorer (MAX) and navigate to the Advanced page of the camera file property page. Use the following guidelines to adjust the Clamp Start and Clamp Stop values until the image is corrected:

- Minimum Clamp Start is 100
- Maximum Clamp Stop is 120
- Difference between Clamp Start and Clamp Stop is at least 10

Signal Connections

This chapter describes cable connections for the IMAQ 1409 devices.

BNC Connector

The BNC external connector supplies an immediate connection (RSE mode only) to the 1409 device VIDEO0 input. To use the VIDEO0 connection on the 68-pin VHDCI I/O connector, you must connect VIDEO0+ to the signal and VIDEO0– to ground.

To connect a camera to VIDEO0, first verify that the W1 jumper is intact. Next, use the 2 m BNC cable shipped with the IMAQ 1409 to connect to the BNC connector.

Figure 4-1 shows the BNC connector pin assignments.

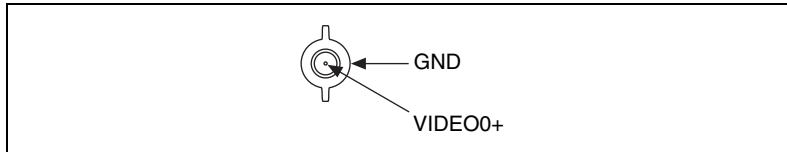

Figure 4-1. BNC Connector Pin Assignment

Digital I/O Connector

The 68-pin VHDCI connector connects to all video signals (VIDEO0, VIDEO1, VIDEO2, and VIDEO3), the external digital I/O lines, triggers, and external signals. To access these connections, you can build your own custom cable or use one of the optional National Instruments cables.



Note If you are using the VIDEO0 connection on the 68-pin VHDCI connector, you must unplug the BNC cable.

Figure 4-2 shows the pinout of the 68-pin VHDCI connector.

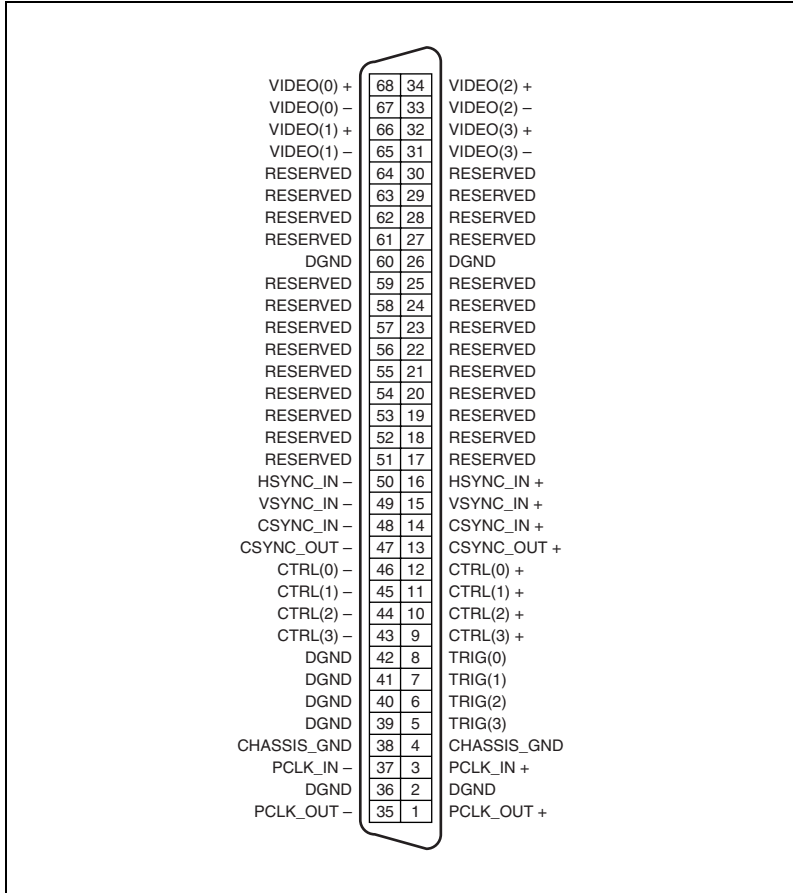

Figure 4-2. I/O Connector Pin Assignments

Digital I/O Connector Signal Connection Descriptions

Table 4-1 describes each signal connection on the 68-pin VHDCI connector.

Table 4-1. I/O Connector Signals

Signal Name	Description
VIDEO0±	VIDEO0± supports RSE connection only. To operate in RSE mode, you must connect VIDEO0– to GND. When you use VIDEO0+ or VIDEO0–, you must disconnect the BNC connector.
VIDEO<3..1>±	VIDEO<3..1>± allows for a DIFF or RSE connection to video channels 1, 2, and 3. To operate in RSE mode, connect VIDEO– to GND.
PCLKIN±	Use PCLKIN± when the IMAQ 1409 is in external lock mode. In this mode, PCLKIN represents the A/D sampling clock. You can select PCLKIN to be either TTL or RS-422 mode and program its polarity through software. In RS-422 mode, both PCLKIN+ and PCLKIN– receive the PCLK signal.
PCLKOUT±	Use PCLKOUT± when your camera requires an external pixel clock source. The IMAQ 1409 can generate variable pixel clock frequencies between 11 MHz and 40 MHz. You can set PCLKOUT± through your software in TTL and RS-422 modes.
HSYNCIN±	Use HSYNCIN± when the IMAQ 1409 is in external lock mode. HSYNC is a synchronization pulse produced at the beginning of each video scan line that keeps a video monitor's horizontal scan rate in step with the transmission of each new line. You can set HSYNCIN for either TTL or RS-422 mode and program its polarity through software. In RS-422 mode, both HSYNCIN+ and HSYNCIN– receive the HSYNC signal.
VSYNCIN±	Use VSYNCIN± when the IMAQ 1409 is in external lock mode. VSYNC is a synchronization pulse generated at the beginning of each video frame that tells the video monitor when to start a new field. You can set VSYNCIN to be either TTL or RS-422 mode and program its polarity through software. In RS-422 mode, both VSYNCIN+ and VSYNCIN– receive the VSYNC signal.
CSYNCIN±	Use CSYNCIN± when the IMAQ 1409 is in CSYNC external mode. CSYNC is a signal consisting of horizontal sync pulses, vertical sync pulses, and equalizing pulses only. You can set CSYNCIN to be either TTL or RS-422 mode and program its polarity through software. In RS-422 mode, both CSYNCIN+ and CSYNCIN– receive the CSYNC signal.
CSYNCOUT	CSYNCOUT is a TTL output of the internal CSYNC signal. In CSYNC external mode, CSYNCOUT maps directly to CSYNCIN. In standard mode, the synchronization circuitry of the IMAQ 1409 generates CSYNCOUT.

Table 4-1. I/O Connector Signals (Continued)

Signal Name	Description
TRIG<3..0>	Triggers<3..0> are TTL I/O lines used to start or stop an acquisition or output an acquisition status. You can program the triggers to be rising- or falling-edge sensitive. You can also program the triggers to be programmatically asserted or unasserted, which is similar in function to a digital I/O line, or to contain specific pulse widths or internal status signals by using the onboard events.
CTRL<3..0>±	Use the control lines on the PCI-1409 to control camera features and timing information, such as generating integration or shutter pulses. You can generate either static or dynamic signals and either TTL or differential signals on these lines.
GND	GND is a direct connection to digital GND on the IMAQ 1409.
CHASSIS_GND	CHASSIS_GND is a direct connection to the computer's chassis, which is grounded through the power cord.

Specifications

This appendix lists the specifications of the PXI-1409 and PCI-1409 devices. These specifications are typical at 25 °C, unless otherwise stated.

Formats Supported

RS-170/NTSC	60 Hz (Interlaced mode: 60 fields/s)
CCIR/PAL.....	50 Hz (Interlaced mode: 50 fields/s)
VGA	60 Hz, 640 × 480 resolution
Variable scan.....	Programmable

Video Input

Quantity	4 monochrome
Input impedance	75 Ω \pm 1%
VIDEO0	RSE (BNC), RSE (VHDCI)
VIDEO<3..0>.....	RSE or DIFF (VHDCI)
Frequency response	30 MHz (–3 dB) typ
Digital antichrominance filter	Programmable (disabled, 3.58 MHz notch filter, or 4.43 MHz notch filter)
Filter characteristics	Attenuation at notch frequency >30 dB
Input range (black to white)	700 mV (calibrated) 50 mV to 1.40 V full scale

Accuracy $\pm 1.5\%$ of reading

Temperature drift < 250 ppm/ $^{\circ}\text{C}$

A/D Conversion

Gray levels1024 (10-bit)

Differential nonlinearity ± 1 LSB max

RMS noise < 0.5 LSB rms

Signal-to-noise ratio56 dB typ

Sampling rate2 MHz to 40 MHz,
externally clocked

Pixel aspect ratioProgrammable $\pm 5\%$ of nominal

Internal Pixel Clock

Frequencies range11 MHz to 40 MHz

Pixel ratio for
standard video sources $\pm 5\%$

Pixel jitter < 2 ns peak

PCI Interface

PCI initiator (master) capabilitySupported

PCI target (slave) capabilitySupported

Data path32 bits

Card voltage5 V only

Card type32-bit half-size card

Parity generation/checking,
error reportingSupported

Target decode speedMedium (1 clock)

Target fast back-to-back capabilitySupported

Resource locking	Supported as a master and slave
PCI interrupts	Interrupts passed on INTA# signal
Base address registers	BAR0 (16 KB) BAR1 (64 KB)
Expansion ROM.....	4 KB
PCI master performance	
Ideal	133 Mbytes/s
Sustained.....	100 Mbytes/s

Power Requirements

Voltage	+5 V (1.5 A)
	+12 V (100 mA)
	-12 V (50 mA)

Physical

Dimensions

PCI-1409	10.7 by 17.5 cm (4.2 by 6.9 in.)
PXI-1409.....	10 by 16 cm (3.9 by 6.3 in.)

Weight

PCI-1409	0.127 kg (0.28 lb)
PXI-1409.....	0.172 kg (0.38 lb)

Environment

Operating temperature.....	0 to 55 °C
Storage temperature	-20 to 70 °C
Relative humidity	10 to 90%, noncondensing

Functional shock (PXI only).....	MIL-T-28800 E Class 3 (per Section 4.5.5.4.1) Half-sine shock pulse, 11 ms duration, 30 g peak, 30 shocks per face
Operational random vibration (PXI only).....	5 to 500 Hz, 0.31 grms, 3 axes
Nonoperational random vibration (PXI only).....	5 to 500 Hz, 2.5 grms, 3 axes



Note Random vibration profiles were developed in accordance with MIL-T-28800E and MIL-STD-810E Method 514. Test levels exceed those recommended in MIL-STD-810E for Category 1 (Basic Transportation, Figures 514.4-1 through 514.4-3).

Safety

The PXI/PCI-1409 meets the requirements of the following standards for safety and electrical equipment for measurement, control, and laboratory use:

- EN 61010-1, IEC 61010-1
- UL 3111-1
- CAN/CSA C22.2 No. 1010.1

Electromagnetic Compatibility

CE, C-Tick, and FCC Part 15 (Class A) Compliant

Electromagnetic emissionsEN 55011 Class A at 10 m
FCC Part 15A above 1 GHz

Electromagnetic immunityEvaluated to EN 61326: 1997/A1:
1998, Table 1



Note For full EMC compliance, you must operate this device with shielded cabling. In addition, all cover and filler panels must be installed. Refer to the Declaration of Conformity (DoC) for this product for any additional regulatory compliance information. To obtain the DoC for this product, click **Declarations of Conformity Information** at ni.com/hardref.nsf/.

Custom Cables

This appendix lists specifications for building custom cables to use with the IMAQ 1409 device.

Cable Specification

National Instruments offers cables and accessories for you to connect to video sources, trigger sources, or synchronization sources. Use the following guidelines when developing your own cables:

- For the video inputs, use a 75 Ω shielded coaxial cable.
- For the digital triggers and synchronization signals, use twisted pairs for each signal.

For information about connector pin assignments, refer to the [Digital I/O Connector](#) section of Chapter 4, [Signal Connections](#).

Connector Specifications

- Video and sync signals—75 Ω impedance
- Trigger signals—TTL
- Type—75 Ω BNC or 68-pin VHDCI receptacle



Technical Support and Professional Services

Visit the following sections of the National Instruments Web site at ni.com for technical support and professional services:

- **Support**—Online technical support resources include the following:
 - **Self-Help Resources**—For immediate answers and solutions, visit our extensive library of technical support resources available in English, Japanese, and Spanish at ni.com/support. These resources are available for most products at no cost to registered users and include software drivers and updates, a KnowledgeBase, product manuals, step-by-step troubleshooting wizards, conformity documentation, example code, tutorials and application notes, instrument drivers, discussion forums, a measurement glossary, and so on.
 - **Assisted Support Options**—Contact NI engineers and other measurement and automation professionals by visiting ni.com/support. Our online system helps you define your question and connects you to the experts by phone, discussion forum, or email.
- **Training**—Visit ni.com/training for self-paced tutorials, videos, and interactive CDs. You also can register for instructor-led, hands-on courses at locations around the world.
- **System Integration**—If you have time constraints, limited in-house technical resources, or other project challenges, NI Alliance Program members can help. To learn more, call your local NI office or visit ni.com/alliance.
- **Declaration of Conformity (DoC)**—A DoC is our claim of compliance with the Council of the European Communities using the manufacturer’s declaration of conformity. This system affords the user protection for electronic compatibility (EMC) and product safety. You can obtain the DoC for your product by visiting ni.com/hardref.nsf.

If you searched ni.com and could not find the answers you need, contact your local office or NI corporate headquarters. Phone numbers for our worldwide offices are listed at the front of this manual. You also can visit the Worldwide Offices section of ni.com/niglobal to access the branch office Web sites, which provide up-to-date contact information, support phone numbers, email addresses, and current events.

Glossary

Symbol	Prefix	Value
p	pico	10^{-12}
n	nano	10^{-9}
μ	micro	10^{-6}
m	milli	10^{-3}
k	kilo	10^3
M	mega	10^6
G	giga	10^9
T	tera	10^{12}

Numbers/Symbols

%	Percent.
+	Positive of, or plus.
-	Negative of, or minus.
/	Per.
+5V	5 V signal.
\pm	Plus or minus.
Ω	Ohm.

A

A	Amperes.
A/D	Analog-to-digital.
AC	Alternating current.

acquisition window	The image size specific to a video standard or camera resolution.
active line region	The region of lines actively being stored. Defined by a line start (relative to the vertical synchronization signal (VSYNC)) and a line count.
active pixel region	The region of pixels actively being stored. Defined by a pixel start (relative to the horizontal synchronization signal(HSYNC)) and a pixel count.
ADC	Analog-to-digital converter. An electronic device, often an integrated circuit, that converts an analog voltage to a digital value.
address	Value that identifies a specific location (or series of locations) in memory.
ANSI	American National Standards Institute.
antichrominance filter	Removes the color information from the video signal.
API	Application programming interface.
area	A rectangular portion of an acquisition window or frame that is controlled and defined by software.
array	Ordered, indexed set of data elements of the same type.
ASIC	Application-Specific Integrated Circuit. A proprietary semiconductor component designed and manufactured to perform a set of specific functions for specific customer needs.
aspect ratio	The ratio of a picture or image's width to its height.
B	
b	Bit. One binary digit, either 0 or 1.
B	Byte. Eight related bits of data, an 8-bit binary number. Also denotes the amount of memory required to store one byte of data.
back porch	The area of the video signal between the rising edge of the horizontal synchronization signal (HSYNC) and the active video information.
black reference level	The level that represents the darkest an image can get. <i>See also</i> white reference level .

buffer	Temporary storage for acquired data.
bus	A group of conductors that interconnect individual circuitry in a computer, such as the PCI bus; typically the expansion vehicle to which I/O or other devices are connected.

C

C	Celsius.
cache	High-speed processor memory that buffers commonly used instructions or data to increase processing throughput.
CCIR	Comite Consultatif International des Radiocommunications. A committee that developed standards for video signals. Also used to describe signals, boards, and cameras that adhere to the CCIR standards.
chroma	The color information in a video signal.
chrominance	<i>See</i> chroma.
CMOS	Complementary metal-oxide semiconductor.
CompactPCI	Refers to the core specification defined by the PCI Industrial Computer Manufacturer's Group (PICMG).
conversion device	Device that transforms a signal from one form to another. For example, analog-to-digital converters (ADCs) for analog input and digital-to-analog converters (DACs) for analog output.
CPU	Central processing unit.
CSYNC	Composite synchronization signal. Signals in a color video system that multiplex all picture information into a single signal, such as NTSC, PAL, or SECAM.

D

D/A	Digital-to-analog.
DAC	Digital-to-analog converter. An electronic device, often an integrated circuit, that converts a digital number into a corresponding analog voltage or current.

DAQ	Data acquisition. (1) Collecting and measuring electrical signals from sensors, transducers, and test probes or fixtures and inputting them to a computer for processing. (2) Collecting and measuring the same kinds of electrical signals with A/D or DIO boards plugged into a computer, and possibly generating control signals with D/A and/or DIO boards in the same computer.
dB	Decibel. The unit for expressing a logarithmic measure of the ratio of two signal levels: $\text{dB} = 20\log_{10} V1/V2$, for signals in volts.
DC	Direct current.
default setting	A default parameter value recorded in the driver. In many cases, the default input of a control is a certain value (often 0).
DMA	Direct memory access. A method by which data can be transferred between computer memory and a device or memory on the bus while the processor does something else. DMA is the fastest method of transferring data to/from computer memory.
DRAM	Dynamic RAM.
driver	Software that controls a specific hardware device, such as an IMAQ or DAQ device.
dynamic range	The ratio of the largest signal level a circuit can handle to the smallest signal level it can handle (usually taken to be the noise level), normally expressed in decibels.

E

EEPROM	Electrically erasable programmable read-only memory. ROM that can be erased with an electrical signal and reprogrammed.
external trigger	A voltage pulse from an external source that triggers an event such as A/D conversion.

F

field	For an interlaced video signal, a field is half the number of horizontal lines needed to represent a frame of video. The first field of a frame contains all the odd-numbered lines, the second field contains all of the even-numbered lines.
FIFO	First-in first-out memory buffer. The first data stored is the first data sent to the acceptor. FIFOs are used on IMAQ devices to temporarily store incoming data until that data can be retrieved.
flash ADC	An ADC whose output code is determined in a single step by a bank of comparators and encoding logic.
frame	A complete image. In interlaced formats, a frame is composed of two fields.
front porch	The area of a video signal between the start of the horizontal blank and the start of the horizontal synchronization signal (HSYNC).
ft	Feet.
function	A set of software instructions executed by a single line of code that may have input and/or output parameters and returns a value when executed.

G

gamma	The nonlinear change in the difference between the video signal's brightness level and the voltage level needed to produce that brightness.
genlock	The process of synchronizing a video source to the signal from a separate video source. The circuitry aligns the video timing signals by locking together the horizontal, vertical, and color subcarrier frequencies and phases and generates a pixel clock that clocks pixel data into memory for display or into another circuit for processing.

H

HSYNC	Horizontal synchronization signal. The synchronization pulse signal produced at the beginning of each video scan line that keeps a video monitor's horizontal scan rate in step with the transmission of each new line.
hue	Represents the dominant color of a pixel. The hue function is a continuous function that covers all the possible colors generated using the R, G, and B primaries. <i>See also</i> RGB .
Hz	Hertz. Frequency in units of 1/second.
I	
IC	Integrated circuit.
in.	Inches.
INL	Integral nonlinearity. A measure of LSB of the worst-case deviation from the ideal A/D or D/A transfer characteristic of the analog I/O circuitry.
instrument driver	A set of high-level software functions, such as NI-IMAQ, that control specific plug-in computer boards. Instrument drivers are available in several forms, ranging from a function callable from a programming language to a virtual instrument (VI) in LabVIEW.
interlaced	A video frame composed of two interleaved fields. The number of lines in a field are half the number of lines in an interlaced frame.
interpreter	A software utility that executes source code from a high-level language such as Basic, C, or Pascal by reading one line at a time and executing the specified operation.
interrupt	A computer signal indicating that the CPU should suspend its current task to service a designated activity.
interrupt level	The relative priority at which a device can interrupt.
IRQ	Interrupt request. <i>See</i> interrupt.

K

k Kilo. The standard metric prefix for 1,000, or 10^3 , used with units of measure such as volts, hertz, and meters.

K Kilo. The prefix for 1,024, or 2^{10} , used with B in quantifying data or computer memory.

L

line count The total number of horizontal lines in the picture.

LSB Least significant bit.

luma The brightness information in the video picture. The luma signal amplitude varies in proportion to the brightness of the video signal and corresponds exactly to the monochrome picture.

luminance *See* luma.

LUT Lookup table. Table containing values used to transform the gray-level values of an image. For each gray-level value in the image, the corresponding new value is obtained from the lookup table.

M

m Meters.

M (1) Mega, the standard metric prefix for 1 million or 10^6 , when used with units of measure such as volts and hertz. (2) Mega, the prefix for 1,048,576, or 2^{20} , when used with B to quantify data or computer memory.

MB Megabyte of memory.

Mbytes/s A unit for data transfer that means 1 million or 10^6 bytes/s.

memory buffer *See* [buffer](#).

memory window Continuous blocks of memory that can be accessed quickly by changing addresses on the local processor.

MSB Most significant bit.

MTBF	Mean time between failure.
mux	Multiplexer. A switching device with multiple inputs that selectively connects one of its inputs to its output.
N	
NI-IMAQ	Driver software for National Instruments IMAQ hardware.
noninterlaced	A video frame where all the lines are scanned sequentially, instead of divided into two frames as in an interlaced video frame.
NTSC	National Television Standards Committee. The committee that developed the color video standard used primarily in North America, which uses 525 lines per frame. <i>See also</i> PAL.
number of planes (in an image)	The number of arrays of pixels that compose the image. A gray-level or pseudo-color image is composed of one plane, while an RGB image is composed of three planes (one for the red component, one for the blue, and one for the green).
NVRAM	Nonvolatile RAM. RAM that is not erased when a device loses power or is turned off.
P	
PAL	Phase Alternation Line. One of the European video color standards. PAL uses 625 lines per frame. <i>See also</i> NTSC.
PCI	Peripheral Component Interconnect. A high-performance expansion bus architecture originally developed by Intel to replace ISA and EISA. PCI offers a theoretical maximum transfer rate of 132 Mbytes/s.
PCLK	Pixel clock signal. Times the sampling of pixels on a video line.
picture aspect ratio	The ratio of the active pixel region to the active line region. For standard video signals like RS-170 or CCIR, the full-size picture aspect ratio normally is 4/3 (1.33).
pixel aspect ratio	The ratio between the physical horizontal size and the vertical size of the region covered by the pixel. An acquired pixel should optimally be square, thus the optimal value is 1.0, but typically it falls between 0.95 and 1.05, depending on camera quality.

pixel clock	Divides the incoming horizontal video line into pixels.
pixel count	The total number of pixels between two horizontal synchronization signals (HSYNCS). The pixel count determines the frequency of the pixel clock.
PLL	Phase-locked loop. Circuitry that provides a very stable pixel clock that is referenced to another signal, such as an incoming horizontal synchronization signal (HSYNC).
PXI	PCI eXtensions for Instrumentation. An open specification that builds on the CompactPCI specification by adding instrumentation-specific features.

R

relative accuracy	A measure in LSB of the accuracy of an ADC; it includes all nonlinearity and quantization errors but does not include offset and gain errors of the circuitry feeding the ADC.
resolution	(1) The number of rows and columns of pixels. An image composed of m rows and n columns has a resolution of $m \times n$. This image has n pixels along its horizontal axis and m pixels along its vertical axis. (2) The smallest signal increment that can be detected by a measurement system. Resolution can be expressed in bits, proportions, or a percentage of full scale. For example, a system has 12-bit resolution, one part in 4,096 resolution, and 0.0244 percent of full scale.
RGB	Color encoding scheme using red, green, and blue (RGB) color information where each pixel in the color image is encoded using 32 bits: 8 bits for red, 8 bits for green, 8 bits for blue, and 8 bits for the alpha value (unused).
ribbon cable	A flat cable in which the conductors are side by side.
ROI	Region of interest. (1) An area of the image that is graphically selected from a window displaying the image. This area can be used focus further processing. (2) A hardware-programmable rectangular portion of the acquisition window.
RSE	Referenced single-ended. All measurements are made with respect to a common reference measurement system or a ground. Also called a grounded measurement system.

RTSI bus Real-Time System Integration Bus. The National Instruments timing bus that connects IMAQ and DAQ boards directly by means of connectors on top of the boards for precise synchronization of functions.

S

saturation The amount of white added to a pure color. Saturation relates to the richness of a color. A saturation of zero corresponds to a pure color with no white added. Pink is a red with low saturation.

scaling down circuitry Circuitry that scales down the resolution of a video signal.

scatter-gather DMA A type of DMA that allows the DMA controller to reconfigure on-the-fly.

SRAM Static RAM.

StillColor A post-processing algorithm that allows the acquisition of high-quality color images generated either by an RGB or composite (NTSC or PAL) camera using a monochrome video acquisition board.

sync Tells the display where to put a video picture. The horizontal sync indicates the picture's left-to-right placement and the vertical sync indicates top-to-bottom placement.

system RAM RAM installed on a personal computer and used by the operating system, as contrasted with onboard RAM.

T

transfer rate The rate, measured in bytes/s, at which data is moved from source to destination after software initialization and set up operations. The maximum rate at which the hardware can operate.

trigger Any event that causes or starts some form of data capture.

trigger control and mapping circuitry Circuitry that routes, monitors, and drives external and RTSI bus trigger lines. You can configure each of these lines to start or stop acquisition on a rising or falling edge.

TTL Transistor-transistor logic.

U

UV plane *See* YUV.

V

V Volts.

value The grayscale intensity of a color pixel computed as the average of the maximum and minimum red, green, and blue values of that pixel.

VCO Voltage-controlled oscillator. An oscillator that changes frequency depending on a control signal. Use VCO in a phase-locked loop to generate a stable pixel clock.

VI Virtual Instrument. (1) A combination of hardware and/or software elements, typically used with a PC, that has the functionality of a classic stand-alone instrument. (2) A LabVIEW software module (VI), which consists of a front panel user interface and a block diagram program.

video line A video line consists of a horizontal synchronization signal, back porch, active pixel region, and a front porch.

VSYNC Vertical synchronization signal. The synchronization pulse generated at the beginning of each video field that tells the video monitor when to start a new field.

W

white reference level The level that defines what is white for a particular video system. *See also* [black reference level](#).

Y

YUV A representation of a color image used for the coding of NTSC or PAL video signals. The luma information is called Y, while the chroma information is represented by two components, U and V representing the coordinates in a color plane.

Index

Numerics

10-bit ADC, 3-3

10-bit LUT, 3-3

A

acquisition and region-of-interest control, 3-4

A/D conversion specifications, A-2

ADC, 10-bit, 3-3

analog bandwidth control circuitry, 3-2

analog front end considerations, 3-5

antichrominance filter, 3-3

application software

 Vision Development Module, 1-5

B

BNC connector

 avoiding VIDEO0 connection with 68-pin

 VHDCI connector (note), 4-1

 pin assignments (figure), 4-1

 signal connections, 4-1

C

cables

 custom cable specifications, B-1

 optional equipment, 2-2

 required cables, 2-1

CHASSIS_GND signal (table), 4-4

CompactPCI specifications, 1-2

composite synchronization. *See* CSYNC

configuration, parts locator diagram, 1-2

contacting National Instruments, C-2

conventions used in the manual, *v*

CSYNC

 CSYNC mux, 3-3

 external acquisition mode, 3-4

 genlock and synchronization circuitry, 3-3

CSYNCIN± signal (table), 4-3

CSYNCOOUT signal (table), 4-3

CTRL<3..0>± signal (table), 4-4

custom cable specifications, B-1

customer

 education, C-1

 professional services, C-1

 technical support, C-1

D

Declaration of Conformity, C-1

diagnostic resources, C-1

DMA controllers, 3-3

documentation

 conventions used in the manual, *v*

 online library, C-1

drivers

 instrument, C-1

 software, C-1

E

electromagnetic compatibility
 specifications, A-4

environment specifications, A-3

equipment, optional, 2-2

example code, C-1

external lock mode description, 3-5

F

formats supported, A-1
front end considerations, 3-5
functional overview, 3-1

G

gain and offset circuitry, programmable, 3-2
GND signal (table), 4-4

H

hardware overview
 10-bit LUT, 3-3
 acquisition and region-of-interest control, 3-4
 acquisition modes, 3-4
 block diagram, 3-2
 CSYNC mux, 3-3
 digital antichrominance filter, 3-3
 functional overview, 3-1
 genlock and synchronization circuitry, 3-3
 PCI Interface, 3-3
 PCLK, HSYNC, VSYNC mux, 3-3
 programmable gain and offset, 3-2
 RTSI bus, 3-4
 scatter-gather DMA controllers, 3-3
 video mux, 3-2

help

 professional services, C-1
 technical support, C-1

HSYNC

 genlock and synchronization circuitry, 3-3

 PCLK, HSYNC, VSYNC mux, 3-3

HSYNCIN± signal (table), 4-3

I

installation
 See also configuration
 procedure for, 2-5
 unpacking the PXI/PCI 1409, 2-2
instrument drivers, C-1
integration with DAQ and motion control, 1-5
internal pixel clock specifications, A-2
I/O connector
 avoiding VIDEO0 connection with BNC connector, 4-1
 custom cable specifications, B-1
 pin assignments (figure), 4-2
 signal descriptions (table), 4-3

K

KnowledgeBase, C-1

L

LabVIEW

 Vision Builder AI, 1-4

lock mode, external, 3-5

lookup table, 10-bit LUT, 3-3

M

motion control, integrating with, 1-6

N

National Instruments

 customer education, C-1

 Declaration of Conformity, C-1

 professional services, C-1

 system integration services, C-1

 technical support, C-1

 worldwide offices, C-2

NI-IMAQ driver software, 1-3

O

online technical support, C-1

P

parts locator diagram, 1-2

PCI interface, 3-3

specifications, A-2

PCLK

genlock and synchronization

circuitry, 3-3

internal pixel clock specifications, A-2

PCLK, HSYNC, VSYNC mux, 3-3

PCLKIN± signal (table), 4-3

PCLKOUT± signal (table), 4-3

phone technical support, C-2

physical specifications, A-3

pin assignments

BNC connector (figure), 4-1

I/O connector (figure), 4-2

pixel clock. *See* PCLK

power requirements, A-3

professional services, C-1

programmable gain and offset circuitry, 3-2

programming examples, C-1

PXI/PCI-1409 devices

See also hardware overview

features and overview, 1-1

optional equipment, 2-2

requirements for getting started, 2-1

safety information, 2-3

software programming choices, 1-3

National Instruments IMAQ

Vision, 1-4

NI-IMAQ driver software, 1-3

unpacking, 2-2

PXI-1409 device

See also PXI/PCI-1409 devices

pins used (table), 1-3

using with CompactPCI, 1-2

R

region of interest control circuitry, 3-4

RTSI bus, 3-4

S

safety information, 2-3

safety specifications, A-4

scatter-gather DMA controllers, 3-3

signal connections

BNC connector, 4-1

I/O connector, 4-1

pin assignments (figure), 4-2

signal descriptions (table), 4-3

software

Vision Development Module, 1-5

software drivers, C-1

software programming choices

National Instruments IMAQ Vision, 1-4

NI-IMAQ driver software, 1-3

specifications

A/D conversion, A-2

electromagnetic compatibility, A-4

environment, A-3

formats supported, A-1

internal pixel clock, A-2

PCI interface, A-2

physical, A-3

power requirements, A-3

safety, A-4

video input, A-1

standard acquisition mode, 3-4

support, technical, C-1

SYNC mux, 3-3

synchronization circuitry, 3-3

system integration services, C-1

system requirements, 2-1

T

technical support, C-1
telephone technical support, C-2
training, customer, C-1
TRIG<3..0> signal (table), 4-4
troubleshooting resources, C-1

V

vertical synchronization. *See* VSYNC
VHDCI connector. *See* I/O connector
video input specifications, A-1
video mux, 3-2
VIDEO<3..1>± signal (table), 4-3
VIDEO0 signal, avoiding 68-pin VHDCI
connector with BNC connection (note), 4-1

VIDEO0± signal (table), 4-3

VSYNC

genlock and synchronization
circuitry, 3-3

PCLK, HSYNC, VSYNC mux, 3-3

VSYNCIN± signal (table), 4-3

W

Web

professional services, C-1
technical support, C-1

worldwide technical support, C-2