

COMPREHENSIVE SERVICES

We offer competitive repair and calibration services, as well as easily accessible documentation and free downloadable resources.

SELL YOUR SURPLUS

We buy new, used, decommissioned, and surplus parts from every NI series. We work out the best solution to suit your individual needs.

 Sell For Cash  Get Credit  Receive a Trade-In Deal

OBSOLETE NI HARDWARE IN STOCK & READY TO SHIP

We stock **New**, **New Surplus**, **Refurbished**, and **Reconditioned** NI Hardware.



Bridging the gap between the manufacturer and your legacy test system.

 1-800-915-6216

 www.apexwaves.com

 sales@apexwaves.com

All trademarks, brands, and brand names are the property of their respective owners.

Request a Quote

 **CLICK HERE**

PXI-6052E

E SERIES CALIBRATION FIXTURE INSTALLATION GUIDE

E Series Calibration Fixture for E and S Series Devices

The E Series calibration fixture connects the calibration equipment to the E or S Series device you want to calibrate. The calibration fixture provides a simple connection scheme and eliminates the need to disconnect and reconnect cables at each step of the calibration procedure.

What You Need to Get Started

To set up and use the E Series calibration fixture, you need the following items:

- E Series calibration fixture
- E Series Calibration Fixture Installation Guide*
- 68-pin shielded cable
- Digital multimeter (DMM)
- Calibrator
- Counter
- E or S Series device to be calibrated
- A computer

Required Software

National Instruments Calibration Executive is a software tool for calibrating I/O channels on NI measurement devices. You can operate Calibration Executive in either automatic or manual mode. The hardware you need to use Calibration Executive differs according to which E or S Series device you want to calibrate. The list of recommended hardware for use with Calibration Executive can be found at ni.com/support/calibrat/required_equipment.htm.

DAQCard™, DAQPad™, National Instruments™, NI™, ni.com™, and NI-DAQ™ are trademarks of National Instruments Corporation. Product and company names mentioned herein are trademarks or trade names of their respective companies. For patents covering National Instruments products, refer to the appropriate location: **Help»Patents** in your software, the `patents.txt` file on your CD, or ni.com/patents.

September 2002
322171C-01

Installing the E Series Calibration Fixture

The calibration fixture provides a cabling point between the calibration equipment and the unit under test (UUT), in this case the E or S Series device. All cabling should pass through the calibration fixture. Use only the shielded cables listed at ni.com/support/calibrat/required_equipment.htm to connect the calibration fixture to the UUT.

To install the E Series calibration fixture, complete the following steps:

1. Connect a 68-pin shielded cable from the back of the E Series device to the calibration fixture.
2. Using standard banana plugs, connect the HI and LO outputs from the calibrator to the calibrator inputs of the calibration fixture. Refer to Figures 1 and 2 to see how to connect the hardware components of the calibration system.
3. If the calibrator has a guard terminal, connect it to the guard input of the calibration fixture. Refer to Figure 2 for an illustration of this connection configuration.
4. Connect the HI and LO inputs of the DMM to the DMM outputs of the calibration fixture.
5. Using a BNC connector, connect the counter to the frequency counter terminal of the calibration fixture.

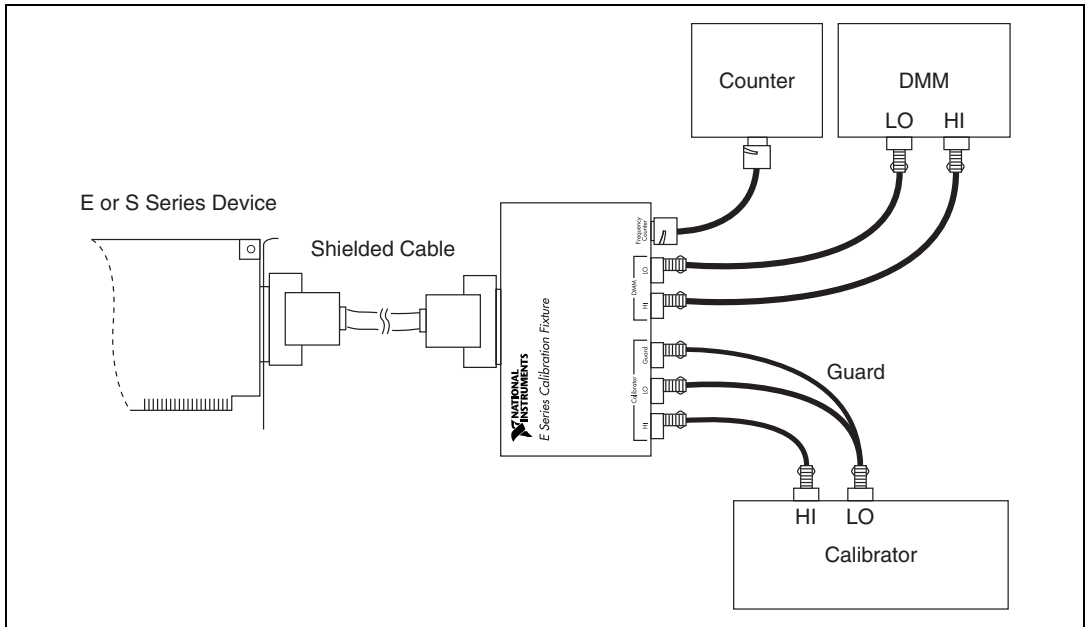

Figure 1. Calibration Fixture Connections for a Calibrator without a Guard Terminal

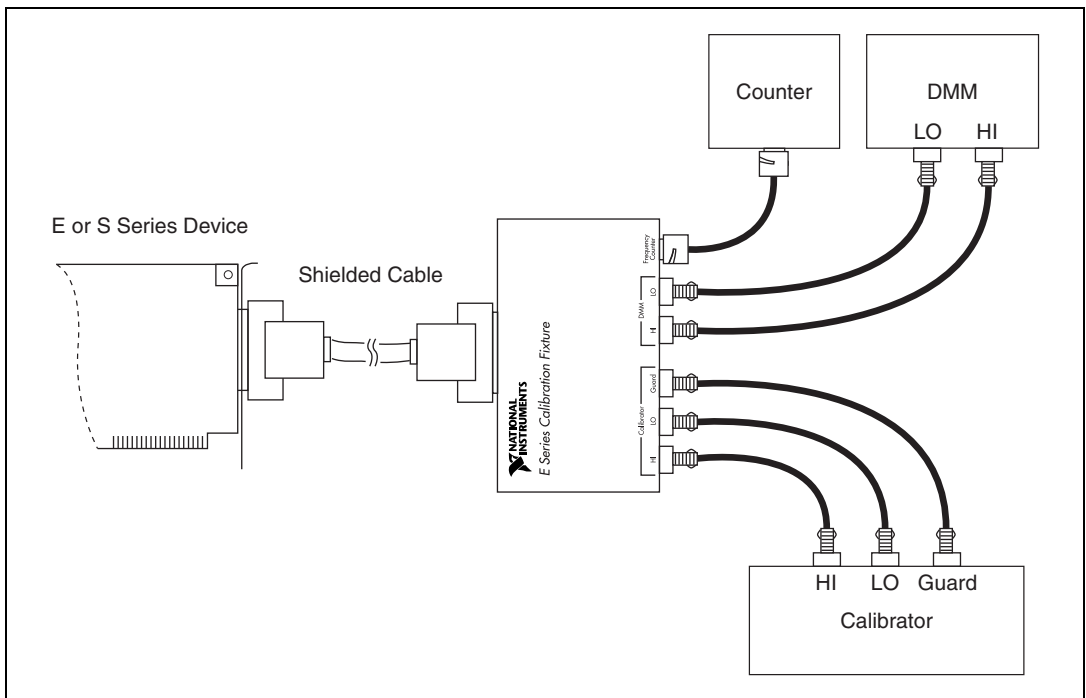

Figure 2. Calibration Fixture Connections for a Calibrator with a Guard Terminal

Operating the Calibration Fixture

The calibration fixture connects the DMM, calibrator, and counter inputs to the correct pins on the E or S Series device. Because some E or S Series device connections vary, the calibration fixture automatically reroutes the incoming signals according to the device being tested.

The digital input/output (DIO) lines on the UUT control the connections inside the calibration fixture. Table 1 shows how the digital lines affect the connections between the UUT and the external instruments.

Table 1. DIO Line Selection

Digital Control Line	Calibration Fixture Operation
DIO(0)	1 Refer to Table 2 to determine the status of this digital line, according to the device being calibrated.
	0 Refer to Table 2 to determine the status of this digital line, according to the device being calibrated.
DIO(1)	1 Selects DAC1 to be placed on the DMM output
	0 Selects DAC0 to be placed on the DMM output
DIO(2)	1 Selects FOUT to be placed on the counter output
	0 Selects CTROUT(0) to be placed on the counter output

Table 2. DIO(0) Line Selection by Device

Device Family	Product Name	Digital Line Status
NI 607XE	NI PCI-MIO-16E-1, NI PXI-6070E, NI DAQPad-6070E, AT-MIO-16E-1, NI PCI/PXI-6071E	1
NI 606XE	AT-MIO-16E-2, AT-MIO-16E-3, DAQCard-6062E	1
NI 6052E	NI PCI/PXI-6052E	1

Table 2. DIO(0) Line Selection by Device (Continued)

Device Family	Product Name	Digital Line Status
NI 604XE	NI PCI-MIO-16E-4, NI PCI-7030/6040E, NI PXI-6040E, NI PXI-7030/6040E, NI DAQCard-AI-16E-4	1
NI 603XE family (with the exception of the NI 6034E/6035E/6036E)	NI PCI-MIO-16XE-10, NI PCI-7030/6030E, NI PXI-6030E, NI PXI-7030/6030E, NI AT-MIO-16XE-10, NI PCI/PXI-6031, NI PCI-6032E, NI AT-AI-16XE-10, NI PCI-6033E	0
NI 6034E/6035E/6036E	NI PCI-6034E, NI PCI-6035E, NI PCI-6036E, NI DAQCard-6036E	1
NI 602XE	NI AT-MIO-16E-10, NI DAQPad-6020E, NI AT-MIO-16DE-10, NI PCI-6023E, NI PCI-6024E, NI DAQCard-6024E, NI PCI/PXI-6025E	1
NI 601XE	NI PCI-MIO-16XE-50, NI AT-MIO-16XE-50, NI DAQCard-AI-16XE-50	0
NI 61XX	NI PCI-6110, NI PCI-6111, NI PCI/PXI-6115, NI PCI/PXI-6120	0



Note If the E or S Series device you want to calibrate does not appear in this table, refer to the NI-DAQ VI or function reference help file.

Specifications

Maximum Working Voltage

Maximum working voltage refers to the signal voltage plus the common-mode voltage.

Channel-to-earth..... 42 V

Channel-to-channel 42 V

Environmental

Operating temperature..... 0 to 55 °C

Humidity 10 to 90% relative humidity,
noncondensing

Physical

Dimensions (not including connectors)	13.653 by 7.62 by 3.334 cm (5.375 by 3.000 by 1.313 in.)
I/O connectors	One 68-pin male SCSI-II type; five gold-plated banana jacks; one 50 Ω BNC jack



Note For full EMC and EMI compliance, you must operate this device with shielded cabling. In addition, all covers and filler panels must be installed. See the Declaration of Conformity (DoC) for this product for any additional regulatory compliance information. To obtain the DoC for this product, click **Declaration of Conformity** at ni.com/hardref.nsf/. This Web site lists the DoCs by product family. Select the appropriate product family, followed by the product, and a link to the DoC (in Adobe Acrobat format) appears. Click the Acrobat icon to download or read the DoC.