

COMPREHENSIVE SERVICES

We offer competitive repair and calibration services, as well as easily accessible documentation and free downloadable resources.

SELL YOUR SURPLUS

We buy new, used, decommissioned, and surplus parts from every NI series. We work out the best solution to suit your individual needs.

 Sell For Cash  Get Credit  Receive a Trade-In Deal

OBSOLETE NI HARDWARE IN STOCK & READY TO SHIP

We stock **New**, **New Surplus**, **Refurbished**, and **Reconditioned** NI Hardware.



Bridging the gap between the manufacturer and your legacy test system.

 1-800-915-6216

 www.apexwaves.com

 sales@apexwaves.com

All trademarks, brands, and brand names are the property of their respective owners.

Request a Quote

 **CLICK HERE**

PXI-6723

PXI/PXI Express

This document provides basic installation instructions for National Instruments PXI and PXI Express DAQ modules. Refer to the documentation specific to your DAQ module for more information.

Unpacking the Kit



Caution To prevent electrostatic discharge (ESD) from damaging the device, ground yourself using a grounding strap or by holding a grounded object, such as your computer chassis.

1. Touch the antistatic package to a metal part of the computer chassis.
2. Remove the device from the package and inspect the device for loose components or any other sign of damage.



Caution Never touch the exposed pins of connectors.



Note Do not install a device if it appears damaged in any way.

3. Unpack any other items and documentation from the kit.

Store the device in the antistatic package when the device is not in use.

Installing the Software

Back up any applications before upgrading your software. You must be an Administrator to install NI software on your computer. Refer to the *NI-DAQmx Readme* on the software media for supported application software and versions.

1. If applicable, install an application development environment (ADE), such as LabVIEW, Microsoft Visual Studio®, or LabWindows™/CVI™.
2. Install the NI-DAQmx driver software.

Installing the Module

1. (Optional) If you are using a MXI-Express connected chassis, turn off your computer.



Note For more information about using MXI-Express chassis, refer to your chassis manual.

2. Power off and unplug the PXI/PXI Express chassis. Refer to your chassis manual to install or configure the chassis.



Caution Refer to the *Read Me First: Safety and Electromagnetic Compatibility* with your PXI/PXI Express chassis or device before removing covers or connecting or disconnecting signal wires.

Figure 1. Installing a PXI/PXI Express Module in the Chassis

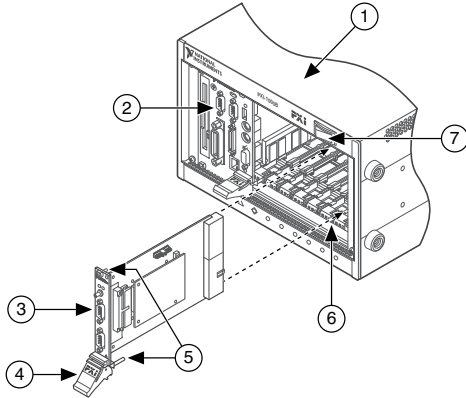

- | | |
|--|--------------------------------|
| 1. PXI/PXI Express Chassis | 5. Front-Panel Mounting Screws |
| 2. PXI/PXI Express Chassis or MXI-Express Controller | 6. Module Guides |
| 3. PXI/PXI Express Module | 7. Power Switch |
| 4. Injector/Ejector Handle | |

3. Identify a supported PXI/PXI Express slot in the chassis.

Some modules have PXI/PXI Express slot requirements; for information, refer to the module documentation.

Figure 2. Symbols for PXI Express/PXI Express Hybrid/PXI Slots

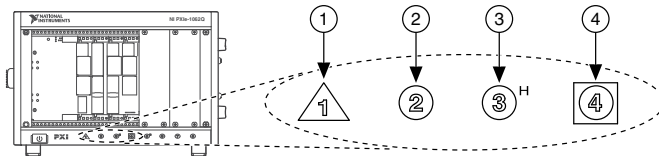

- | | |
|---------------------------------------|---------------------------------------|
| 1. PXI Express System Controller Slot | 3. PXI Express Hybrid Peripheral Slot |
| 2. PXI Peripheral Slot | 4. PXI Express System Timing Slot |

If you are using a PXI Express chassis, you can place PXI modules in the PXI slots. If a PXI module is hybrid slot compatible, you can use the PXI Express Hybrid slots.

PXI Express modules can be placed only in PXI Express slots and PXI Express Hybrid slots. Refer to the chassis documentation for details.

4. Remove the filler panel of an unused PXI/PXI Express slot.

5. Touch any metal part of the chassis to discharge static electricity.
6. Ensure that the PXI/PXI Express module injector/ejector handle is not latched and swings freely.
7. Place the PXI/PXI Express module edges into the module guides at the top and bottom of the chassis.
8. Slide the module into the PXI/PXI Express slot to the rear of the chassis.
9. When you begin to feel resistance, pull up on the injector/ejector handle to latch the device.
10. Secure the module front panel to the chassis using the front-panel mounting screws.
11. Plug in and power on your PXI/PXI Express chassis.
12. (Optional) If you are using a MXI-Express connected chassis, turn on your computer.
13. If applicable, install accessories and/or terminal blocks as described in the installation guides.
14. Attach sensors and signal lines to the device, terminal block, or accessory terminals. Refer to the documentation for your DAQ device or accessory for terminal/pinout information.

Configuring the Device in NI MAX

Use NI MAX, installed automatically with NI-DAQmx, to configure your National Instruments hardware.

1. Launch NI MAX.
2. In the Configuration pane, double-click **Devices and Interfaces** to see the list of installed devices. The module is nested under the chassis.

If you do not see your device listed, press <F5> to refresh the list of installed devices.

3. Right-click the device and select **Self-Test** to perform a basic verification of hardware resources.
4. (Optional) Right-click the device and select **Configure** to add accessory information and configure the device.
5. Right-click the device and select **Test Panels** to test device functionality.

Click **Start** to test the device functions, and then **Stop** and **Close** to exit the test panel. If the test panel displays an error message, refer to ni.com/support.

6. If your device supports Self-Calibration, right-click the device and select **Self-Calibrate**.

A window reports the status of the calibration. Click **Finish**. For more information about Self-Calibration, refer to the device user manual.



Note Remove all sensors and accessories from your device before Self-Calibrating.

Programming

Complete the following steps to configure a measurement using the DAQ Assistant from NI MAX.

1. In NI MAX, right-click **Data Neighborhood** and select **Create New** to open the DAQ Assistant.
2. Select **NI-DAQmx Task** and click **Next**.
3. Select **Acquire Signals** or **Generate Signals**.
4. Select the I/O type, such as analog input, and the measurement type, such as voltage.
5. Select the physical channel(s) to use and click **Next**.
6. Name the task and click **Finish**.
7. Configure individual channel settings. Each physical channel you assign to a task receives a virtual channel name. Click **Details** for physical channel information. Configure the timing and triggering for your task.
8. Click **Run**.

Troubleshooting

For software installation problems, go to ni.com/support/daqmx.

For hardware troubleshooting, go to ni.com/support and enter your device name, or go to ni.com/kb.

Find device terminal/pinout locations in MAX by right-clicking the device name in the Configuration pane and selecting **Device Pinouts**.

To return your National Instruments hardware for repair or device calibration, go to ni.com/info and enter `rdseenn`, which starts the Return Merchandise Authorization (RMA) process.

Where to Go Next

Additional resources are online at ni.com/gettingstarted and in the *NI-DAQmx Help*. To access *NI-DAQmx Help*, launch NI MAX and go to **Help»Help Topics»NI-DAQmx»NI-DAQmx Help**.

Examples

NI-DAQmx includes example programs to help you get started developing an application. Modify example code and save it in an application, or use examples to develop a new application or add example code to an existing application.

To locate LabVIEW, LabWindows/CVI, Measurement Studio, Visual Basic, and ANSI C examples, go to ni.com/info and enter the Info Code `daqmxexp`. For additional examples, refer to ni.com/examples.

Related Documentation

To find the documentation for your DAQ device or accessory—including safety, environmental, and regulatory information documents—go to ni.com/manuals and enter the model number.

Worldwide Support and Services

The NI website is your complete resource for technical support. At ni.com/support, you have access to everything from troubleshooting and application development self-help resources to email and phone assistance from NI Application Engineers.

Visit ni.com/services for NI Factory Installation Services, repairs, extended warranty, and other services.

Visit ni.com/register to register your NI product. Product registration facilitates technical support and ensures that you receive important information updates from NI.

NI corporate headquarters is located at 11500 North Mopac Expressway, Austin, Texas, 78759-3504. NI also has offices located around the world. For telephone support in the United States, create your service request at ni.com/support or dial 1 866 ASK MYNI (275 6964). For telephone support outside the United States, visit the *Worldwide Offices* section of ni.com/global to access the branch office websites, which provide up-to-date contact information, support phone numbers, email addresses, and current events.

Refer to the *NI Trademarks and Logo Guidelines* at ni.com/trademarks for information on NI trademarks. Other product and company names mentioned herein are trademarks or trade names of their respective companies. For patents covering NI products/technology, refer to the appropriate location: **Help»Patents** in your software, the `patents.txt` file on your media, or the *National Instruments Patent Notice* at ni.com/patents. You can find information about end-user license agreements (EULAs) and third-party legal notices in the readme file for your NI product. Refer to the *Export Compliance Information* at ni.com/legal/export-compliance for the NI global trade compliance policy and how to obtain relevant HTS codes, ECCNs, and other import/export data. NI MAKES NO EXPRESS OR IMPLIED WARRANTIES AS TO THE ACCURACY OF THE INFORMATION CONTAINED HEREIN AND SHALL NOT BE LIABLE FOR ANY ERRORS. U.S. Government Customers: The data contained in this manual was developed at private expense and is subject to the applicable limited rights and restricted data rights as set forth in FAR 52.227-14, DFAR 252.227-7014, and DFAR 252.227-7015.

© 2016 National Instruments. All rights reserved.

376575A-01 Aug16