

COMPREHENSIVE SERVICES

We offer competitive repair and calibration services, as well as easily accessible documentation and free downloadable resources.

SELL YOUR SURPLUS

We buy new, used, decommissioned, and surplus parts from every NI series. We work out the best solution to suit your individual needs.

 Sell For Cash  Get Credit  Receive a Trade-In Deal

OBSOLETE NI HARDWARE IN STOCK & READY TO SHIP

We stock **New**, **New Surplus**, **Refurbished**, and **Reconditioned** NI Hardware.



Bridging the gap between the manufacturer and your legacy test system.

 1-800-915-6216

 www.apexwaves.com

 sales@apexwaves.com

All trademarks, brands, and brand names are the property of their respective owners.

Request a Quote

 **CLICK HERE**

PXI-7344

Motion Control

National Instruments 7340
User Manual and Specifications

March 2013
370838B-01



Worldwide Technical Support and Product Information

ni.com

Worldwide Offices

Visit ni.com/niglobal to access the branch office Web sites, which provide up-to-date contact information, support phone numbers, email addresses, and current events.

National Instruments Corporate Headquarters

11500 North Mopac Expressway Austin, Texas 78759-3504 USA Tel: 512 683 0100

For further support information, refer to the *Technical Support and Professional Services* appendix. To comment on National Instruments documentation, refer to the National Instruments Web site at ni.com/info and enter the Info Code feedback.

© 2003–2013 National Instruments. All rights reserved.

Important Information

Warranty

The National Instruments 7340 is warranted against defects in materials and workmanship for a period of one year from the date of shipment, as evidenced by receipts or other documentation. National Instruments will, at its option, repair or replace equipment that proves to be defective during the warranty period. This warranty includes parts and labor.

The media on which you receive National Instruments software are warranted not to fail to execute programming instructions, due to defects in materials and workmanship, for a period of 90 days from date of shipment, as evidenced by receipts or other documentation. National Instruments will, at its option, repair or replace software media that do not execute programming instructions if National Instruments receives notice of such defects during the warranty period. National Instruments does not warrant that the operation of the software shall be uninterrupted or error free.

A Return Material Authorization (RMA) number must be obtained from the factory and clearly marked on the outside of the package before any equipment will be accepted for warranty work. National Instruments will pay the shipping costs of returning to the owner parts which are covered by warranty.

National Instruments believes that the information in this document is accurate. The document has been carefully reviewed for technical accuracy. In the event that technical or typographical errors exist, National Instruments reserves the right to make changes to subsequent editions of this document without prior notice to holders of this edition. The reader should consult National Instruments if errors are suspected. In no event shall National Instruments be liable for any damages arising out of or related to this document or the information contained in it.

EXCEPT AS SPECIFIED HEREIN, NATIONAL INSTRUMENTS MAKES NO WARRANTIES, EXPRESS OR IMPLIED, AND SPECIFICALLY DISCLAIMS ANY WARRANTY OF MERCHANTABILITY OR FITNESS FOR A PARTICULAR PURPOSE. CUSTOMER'S RIGHT TO RECOVER DAMAGES CAUSED BY FAULT OR NEGLIGENCE ON THE PART OF NATIONAL INSTRUMENTS SHALL BE LIMITED TO THE AMOUNT THEREOF PAID BY THE CUSTOMER. NATIONAL INSTRUMENTS WILL NOT BE LIABLE FOR DAMAGES RESULTING FROM LOSS OF DATA, PROFITS, USE OF PRODUCTS, OR INCIDENTAL OR CONSEQUENTIAL DAMAGES, EVEN IF ADVISED OF THE POSSIBILITY THEREOF. This limitation of the liability of National Instruments will apply regardless of the form of action, whether in contract or tort, including negligence. Any action against National Instruments must be brought within one year after the cause of action accrues. National Instruments shall not be liable for any delay in performance due to causes beyond its reasonable control. The warranty provided herein does not cover damages, defects, malfunctions, or service failures caused by owner's failure to follow the National Instruments installation, operation, or maintenance instructions; owner's modification of the product; owner's abuse, misuse, or negligent acts; and power failure or surges, fire, flood, accident, actions of third parties, or other events outside reasonable control.

Copyright

Under the copyright laws, this publication may not be reproduced or transmitted in any form, electronic or mechanical, including photocopying, recording, storing in an information retrieval system, or translating, in whole or in part, without the prior written consent of National Instruments Corporation.

National Instruments respects the intellectual property of others, and we ask our users to do the same. NI software is protected by copyright and other intellectual property laws. Where NI software may be used to reproduce software or other materials belonging to others, you may use NI software only to reproduce materials that you may reproduce in accordance with the terms of any applicable license or other legal restriction.

End-User License Agreements and Third-Party Legal Notices

You can find end-user license agreements (EULAs) and third-party legal notices in the following locations:

- Notices are located in the <National Instruments>_Legal Information and <National Instruments> directories.
- EULAs are located in the <National Instruments>\Shared\MDF\Legal\license directory.
- Review <National Instruments>_Legal Information.txt for more information on including legal information in installers built with NI products.

Trademarks

Refer to the *NI Trademarks and Logo Guidelines* at ni.com/trademarks for more information on National Instruments trademarks.

ARM, Keil, and μ Vision are trademarks or registered of ARM Ltd or its subsidiaries.

LEGO, the LEGO logo, WEDO, and MINDSTORMS are trademarks of the LEGO Group. ©2013 The LEGO Group.

TETRIX by Pitsco is a trademark of Pitsco, Inc. ©2013

FIELDBUS FOUNDATION™ and FOUNDATION™ are trademarks of the Fieldbus Foundation.

EtherCAT® is a registered trademark of and licensed by Beckhoff Automation GmbH.

CANopen® is a registered Community Trademark of CAN in Automation e.V.

DeviceNet™ and EtherNet/IP™ are trademarks of ODVA.

Go!, SensorDAQ, and Vernier are registered trademarks of Vernier Software & Technology. Vernier Software & Technology and vernier.com are trademarks or trade dress.

Xilinx is the registered trademark of Xilinx, Inc.

Taprite and Trilobular are registered trademarks of Research Engineering & Manufacturing Inc.

FireWire® is the registered trademark of Apple Inc.

Linux® is the registered trademark of Linus Torvalds in the U.S. and other countries.

Handle Graphics®, MATLAB®, Real-Time Workshop®, Simulink®, Stateflow®, and xPC TargetBox® are registered trademarks, and TargetBox™ and Target Language Compiler™ are trademarks of The MathWorks, Inc.

Tektronix®, Tek, and Tektronix, Enabling Technology are registered trademarks of Tektronix, Inc.

The Bluetooth® word mark is a registered trademark owned by the Bluetooth SIG, Inc.

The ExpressCard™ word mark and logos are owned by PCMCIA and any use of such marks by National Instruments is under license.

The mark LabWindows is used under a license from Microsoft Corporation. Windows is a registered trademark of Microsoft Corporation in the United States and other countries.

Other product and company names mentioned herein are trademarks or trade names of their respective companies.

Patents

For patents covering National Instruments products, refer to the appropriate location: **Help»Patents** in your software, the `patents.txt` file on your media, or the National Instruments Patent Notice at ni.com/patents.

Export Compliance Information

Refer to the *Export Compliance Information* at ni.com/legal/export-compliance for the National Instruments global trade compliance policy and how to obtain relevant HTS codes, ECCNs, and other import/export data.

WARNING REGARDING USE OF NATIONAL INSTRUMENTS PRODUCTS

(1) NATIONAL INSTRUMENTS PRODUCTS ARE NOT DESIGNED WITH COMPONENTS AND TESTING FOR A LEVEL OF RELIABILITY SUITABLE FOR USE IN OR IN CONNECTION WITH SURGICAL IMPLANTS OR AS CRITICAL COMPONENTS IN ANY LIFE SUPPORT SYSTEMS WHOSE FAILURE TO PERFORM CAN REASONABLY BE EXPECTED TO CAUSE SIGNIFICANT INJURY TO A HUMAN.

(2) IN ANY APPLICATION, INCLUDING THE ABOVE, RELIABILITY OF OPERATION OF THE SOFTWARE PRODUCTS CAN BE IMPAIRED BY ADVERSE FACTORS, INCLUDING BUT NOT LIMITED TO FLUCTUATIONS IN ELECTRICAL POWER SUPPLY, COMPUTER HARDWARE MALFUNCTIONS, COMPUTER OPERATING SYSTEM SOFTWARE FITNESS, FITNESS OF COMPILERS AND DEVELOPMENT SOFTWARE USED TO DEVELOP AN APPLICATION, INSTALLATION ERRORS, SOFTWARE AND HARDWARE COMPATIBILITY PROBLEMS, MALFUNCTIONS OR FAILURES OF ELECTRONIC MONITORING OR CONTROL DEVICES, TRANSIENT FAILURES OF ELECTRONIC SYSTEMS (HARDWARE AND/OR SOFTWARE), UNANTICIPATED USES OR MISUSES, OR ERRORS ON THE PART OF THE USER OR APPLICATIONS DESIGNER (ADVERSE FACTORS SUCH AS THESE ARE HEREAFTER COLLECTIVELY TERMED "SYSTEM FAILURES"). ANY APPLICATION WHERE A SYSTEM FAILURE WOULD CREATE A RISK OF HARM TO PROPERTY OR PERSONS (INCLUDING THE RISK OF BODILY INJURY AND DEATH) SHOULD NOT BE RELIANT SOLELY UPON ONE FORM OF ELECTRONIC SYSTEM DUE TO THE RISK OF SYSTEM FAILURE. TO AVOID DAMAGE, INJURY, OR DEATH, THE USER OR APPLICATION DESIGNER MUST TAKE REASONABLY PRUDENT STEPS TO PROTECT AGAINST SYSTEM FAILURES, INCLUDING BUT NOT LIMITED TO BACK-UP OR SHUT DOWN MECHANISMS. BECAUSE EACH END-USER SYSTEM IS CUSTOMIZED AND DIFFERS FROM NATIONAL INSTRUMENTS' TESTING PLATFORMS AND BECAUSE A USER OR APPLICATION DESIGNER MAY USE NATIONAL INSTRUMENTS PRODUCTS IN COMBINATION WITH OTHER PRODUCTS IN A MANNER NOT EVALUATED OR CONTEMPLATED BY NATIONAL INSTRUMENTS, THE USER OR APPLICATION DESIGNER IS ULTIMATELY RESPONSIBLE FOR VERIFYING AND VALIDATING THE SUITABILITY OF NATIONAL INSTRUMENTS PRODUCTS WHENEVER NATIONAL INSTRUMENTS PRODUCTS ARE INCORPORATED IN A SYSTEM OR APPLICATION, INCLUDING, WITHOUT LIMITATION, THE APPROPRIATE DESIGN, PROCESS AND SAFETY LEVEL OF SUCH SYSTEM OR APPLICATION.

Contents

Chapter 1

Introduction

About the NI 7340 Motion Controller	1-1
Features	1-1
Hardware	1-1
RTSI	1-2
What You Need to Get Started	1-2
Software Programming Choices	1-2
National Instruments Application Software	1-3
Optional Equipment	1-3
Motion I/O Connections	1-3
Related Documentation	4

Chapter 2

Configuration and Installation

Software Installation	2-1
Controller Configuration	2-1
Safety Information	2-1
Electromagnetic Compatibility Information	2-3
Hardware Installation	2-3
PXI Motion Controllers	2-4
PCI Motion Controllers	2-5

Chapter 3

Hardware Overview

User Connectors	3-3
Functional Overview	3-4
Dual Processor Architecture	3-4
Embedded Real-Time Operating System (RTOS)	3-4
Trajectory Generators	3-4
Analog Feedback	3-5
Flash Memory	3-5
Axes and Motion Resources	3-5
Axes	3-5
Motion Resources	3-6
Onboard Programs and Buffers	3-7
Host Communications	3-7

Chapter 4 Signal Connections

Motion I/O Connector	4-1
Motion Axis Signals	4-4
Step, Direction, and Inhibit Output Circuit.....	4-5
Limit and Home Inputs	4-5
Wiring Concerns	4-6
Limit and Home Input Circuit	4-6
Encoder Signals	4-7
Encoder <1..4> Phase A/Phase B	4-7
Encoder <1..4> Index (Phase Z)	4-8
Wiring Concerns	4-8
Encoder Input Circuit.....	4-9
Trigger Inputs, Shutdown Input, and Breakpoint Outputs.....	4-9
Wiring Concerns	4-10
Trigger Input, Shutdown Input, and Breakpoint Output Circuits	4-10
Analog Inputs.....	4-11
Wiring Concerns	4-12
Other Motion I/O Connection	4-12
Digital I/O Connector	4-13
PWM Features	4-14
RTSI Connector	4-14
RTSI Signal Considerations.....	4-14

Appendix A Specifications

Appendix B Cable Connector Descriptions

Appendix C Technical Support and Professional Services

Glossary

Index

Introduction

This chapter includes information about the features of the National Instruments PXI/PCI-7340 motion controller and information about operating the device.

About the NI 7340 Motion Controller

The NI 7340 motion controller features advanced motion control with easy-to-use software tools and add-on motion VI libraries for use with LabVIEW.

Features

The NI 7340 motion controller is a combination servo and stepper motor controller for PXI, Compact PCI, and PCI bus computers. The NI 7340 motion controller provides fully programmable motion control for up to four independent or coordinated axes of motion, with dedicated motion I/O for limit and home switches and additional I/O for general-purpose functions.

You can use the NI 7340 motion controller to perform arbitrary and complex motion trajectories using stepper motors or servo devices.

Servo axes can control servo motors, servo hydraulics, servo valves, and other servo devices. Servo axes always operate in closed-loop mode. These axes use quadrature encoders or analog inputs for position and velocity feedback and provide analog command outputs with an industry-standard range of ± 10 V.

Stepper axes can operate in open or closed-loop mode. In closed-loop mode, they use quadrature encoders or analog inputs for position and velocity feedback (closed-loop only), and provide step/direction or clockwise (CW)/counter-clockwise (CCW) digital command outputs. All stepper axes support full, half, and microstepping applications.

Hardware

The NI 7340 is a high performance motion controller that uses an advanced dual-processor architecture including a 32-bit CPU, combined with a digital signal processor (DSP) and custom field programmable gate arrays (FPGAs). The first-in-first-out (FIFO) bus interface and powerful function set provide high-speed communications while off-loading complex motion functions from the host PC for optimum command throughput and system performance.

With the NI 7340 motion controller, you can use full onboard programming to execute up to 10 simultaneous motion programs.

The NI 7340 motion controller features motion profiles that are controlled with enhanced *PID/PIV/ff* servo updates. Each axis has motion I/O for end-of-travel limit and home switch inputs, breakpoint output, trigger input, and encoder feedback. Refer to Appendix A, *Specifications*, for information about the feedback rates. The NI 7340 motion controller also has non-dedicated user I/O including 32 bits of digital I/O and four analog inputs for ± 10 V signals, joystick inputs, or monitoring of analog sensors. Additionally, the NI 7340 motion controller analog inputs can provide feedback for loop closure.

RTSI

The NI 7340 motion controller supports the National Instruments Real-Time System Integration (RTSI) bus. The RTSI bus provides high-speed connectivity between National Instruments products, including image acquisition (IMAQ) and data acquisition (DAQ) products. Using the RTSI bus, you can easily synchronize several functions to a common trigger or timing event across multiple motion, IMAQ, or DAQ devices.

What You Need to Get Started

To set up and use the NI 7340 motion controller, you must have the following items:

- NI PXI-7340 or PCI-7340 motion controller
- NI-Motion 6.1 or later driver software and documentation
- One of the following software packages and documentation:
 - LabVIEW 6.0 or later
 - LabWindows™/CVI™ 7.0 or later
 - Measurement Studio
 - C/C++
 - Microsoft Visual Basic 6.0
- A computer with an available PXI or PCI slot

Software Programming Choices

NI-Motion is a simple but powerful high-level application programming interface (API) that makes programming the NI 7340 motion controller easy. All setup and motion control functions are easily executed by calling into a dynamically-linked library (DLL). You can call these libraries from C, Microsoft Visual Basic, and other high-level languages. Full function sets are available for LabVIEW, LabWindows/CVI, and other industry-standard software programs.

National Instruments Application Software

LabVIEW is based on the graphical programming language, G, and features interactive graphics and a state-of-the-art user interface. In LabVIEW, you can create 32-bit compiled programs and stand-alone executables for custom automation, data acquisition, test, measurement, and control solutions. National Instruments offers the NI-Motion driver software support for LabVIEW, which includes a series of virtual instruments (VIs) for using LabVIEW with National Instruments motion control hardware. The NI-Motion VI library implements the NI-Motion API and a powerful set of demo functions; example programs; and fully operational, high-level application routines.

ANSI C-based LabWindows/CVI also features interactive graphics and a state-of-the-art user interface. Using LabWindows/CVI, you can generate C code for custom data acquisition, test, and measurement and automation solutions. NI-Motion includes a series of sample programs for using LabWindows/CVI with National Instruments motion control hardware.

NI Motion Assistant offers a point-and-click interface for creating motion control sequences quickly and easily. When you have created a motion task, you can use Motion Assistant to output the task in LabVIEW or C code or code recipes.

Optional Equipment

National Instruments offers a variety of products for use with the NI 7340 motion controller, including the following accessories:

- Cables and cable assemblies for motion and digital I/O
- RTSI cable for connection with other National Instruments devices
- Universal Motion Interface (UMI) wiring connectivity blocks with integrated motion signal conditioning and motion inhibit functionality
- Stepper and servo motor compatible drive amplifier units with integrated power supply and wiring connectivity
- Connector blocks and shielded and unshielded 68-pin screw terminal wiring aids

For more specific information about these products, refer to the National Instruments website at ni.com or call your National Instruments sales representative.

Motion I/O Connections

The external motion and digital I/O connectors on the NI 7340 motion controller are high-density, 68-pin female VHDCI connectors.

For custom cables, use the AMP mating connector (NI part number 787801-1).

Related Documentation

The following documents contain information you might find helpful as you read this manual:

- *NI-Motion Help*
- *NI-Motion C Reference Help*
- *NI-Motion VI Help*

Configuration and Installation

This chapter describes how to configure and install the National Instruments PXI/PCI-7340.

Software Installation

Before installing the NI 7340 motion controller, install the NI-Motion driver software and, if appropriate, the NI-Motion VI libraries. For specific installation instructions refer to *Getting Started with NI-Motion for NI 73xx Motion Controllers*, which is installed in the NI-Motion/Documentation folder where you installed NI-Motion. The default directory is <Program Files>\National Instruments\NI-Motion.



Note If you do not install the NI-Motion driver software before attempting to use the NI 7340 motion controller, the system does not recognize the NI 7340 motion controller and you are unable to configure or use the device.

Controller Configuration

Because motion I/O-related configuration of the NI 7340 motion controller is performed entirely with software, it is not necessary to set jumpers for motion I/O configuration.

The PXI-7340 and PCI-7340 controllers are fully compatible with the industry standard *PXI Specification*, Revision 2.0 and the *PCI Local Bus Specification*, Revision 2.2, respectively. This compatibility allows the PXI or PCI system to automatically perform all bus-related configuration and requires no user interaction. It is not necessary to configure jumpers for bus-related configuration, including setting the device base memory and interrupt channel.

Safety Information



Caution The following paragraphs contain important safety information you *must* follow when installing and operating the NI 7340 motion controller and all devices connecting to the NI 7340 motion controller.

Do not operate the hardware in a manner not specified in this document and in the user documentation. Misuse of the hardware can result in a hazard. You can compromise the safety protection if the hardware is damaged in any way. If the hardware is damaged, return it to National Instruments for repair.

Clean the hardware with a soft, nonmetallic brush. Make sure that the hardware is completely dry and free from contaminants before returning it to service.

Do not substitute parts or modify the hardware except as described in this document. Use the hardware only with the chassis, modules, accessories, and cables specified in the installation instructions or specifications. You must have all covers and filler panels installed during operation of the hardware.

Do not operate the hardware in an explosive atmosphere or where there may be flammable gases or fumes unless the hardware is UL (U.S.) or Ex (EU) Certified and marked for hazardous locations. The hardware must be in a suitably rated IP 54 minimum enclosure for hazardous locations. Refer to the hardware's user documentation for more information.

You must insulate signal connections for the maximum voltage for which the hardware is rated. Do not exceed the maximum ratings for the hardware. Do not install wiring while the hardware is live with electrical signals. Do not remove or add connector blocks when power is connected to the system. Avoid contact between your body and the connector block signal when hot swapping hardware. Remove power from signal lines before connecting them to or disconnecting them from the hardware.

Operate the hardware only at or below Pollution Degree 2. Pollution is foreign matter in a solid, liquid, or gaseous state that can reduce dielectric strength or surface resistivity. The following is a description of pollution degrees:

- Pollution Degree 1 means no pollution or only dry, nonconductive pollution occurs. The pollution has no influence. Typical level for sealed components or coated PCBs.
- Pollution Degree 2 means that only nonconductive pollution occurs in most cases. Occasionally, however, a temporary conductivity caused by condensation must be expected. Typical level for most products.
- Pollution Degree 3 means that conductive pollution occurs, or dry, nonconductive pollution occurs that becomes conductive due to condensation.

Operate the hardware at or below the measurement category¹ marked on the hardware label. Measurement circuits are subjected to working voltages² and transient stresses (overvoltage) from the circuit to which they are connected during measurement or test. Measurement categories establish standard impulse withstand voltage levels that commonly occur in electrical distribution systems. The following is a description of measurement categories:

- Measurement Category I is for measurements performed on circuits not directly connected to the electrical distribution system referred to as MAINS³ voltage. This category is for measurements of voltages from specially protected secondary circuits. Such voltage measurements include signal levels, special hardware, limited-energy parts of hardware, circuits powered by regulated low-voltage sources, and electronics.

¹ Measurement categories, also referred to as overvoltage or installation categories, are defined in electrical safety standard IEC 61010-1 and IEC 60664-1.

² Working voltage is the highest rms value of an AC or DC voltage that can occur across any particular insulation.

³ MAINS is defined as a hazardous live electrical supply system that powers hardware. Suitably rated measuring circuits may be connected to the MAINS for measuring purposes.

- Measurement Category II is for measurements performed on circuits directly connected to the electrical distribution system (MAINS³). This category refers to local-level electrical distribution, such as that provided by a standard wall outlet (for example, 115 AC voltage for U.S. or 230 AC voltage for Europe). Examples of Measurement Category II are measurements performed on household appliances, portable tools, and similar hardware.
- Measurement Category III is for measurements performed in the building installation at the distribution level. This category refers to measurements on hard-wired hardware such as hardware in fixed installations, distribution boards, and circuit breakers. Other examples are wiring, including cables, bus bars, junction boxes, switches, socket outlets in the fixed installation, and stationary motors with permanent connections to fixed installations.
- Measurement Category IV is for measurements performed at the primary electrical supply installation typically outside buildings. Examples include electricity meters and measurements on primary overcurrent protection devices and on ripple control units.

To obtain the safety certification(s) for this product, visit ni.com/certification, search by model number or product line, and click the appropriate link in the Certification column.

Electromagnetic Compatibility Information

This product was tested and complies with the regulatory requirements and limits for electromagnetic compatibility (EMC) stated in the product specifications. These requirements and limits provide reasonable protection against harmful interference when the product is operated in the intended operational electromagnetic environment.

This product is intended for use in industrial locations. However, harmful interference may occur in some installations, when the product is connected to a peripheral device or test object, or if the product is used in residential or commercial areas. To minimize interference with radio and television reception and prevent unacceptable performance degradation, install and use this product in strict accordance with the instructions in the product documentation.

Furthermore, any modifications to the product not expressly approved by National Instruments could void your authority to operate it under your local regulatory rules.



Caution To ensure the specified EMC performance, operate this product only with shielded cables and accessories.

Hardware Installation

Install the NI 7340 motion controller in any open compatible expansion slot in the PXI or PCI system. Appendix A, [Specifications](#), lists the typical power required for each controller.

The following instructions are for general installation. Consult the computer user manual or technical reference manual for specific instructions and warnings.



Caution The NI 7340 motion controller is a sensitive electronic device shipped in an antistatic bag. Open only at an approved workstation and observe precautions for handling electrostatic-sensitive devices.



Note When adding or removing a motion controller, you must be logged on with administrator-level access. After you have restarted the system, you may need to refresh Measurement & Automation Explorer (MAX) to view the new controller.

PXI Motion Controllers

1. Power off and unplug the chassis.



Caution To protect yourself and the computer from electrical hazards, the computer *must* remain unplugged until the installation is complete.

2. Choose an unused peripheral slot and remove the filler panel.
3. Touch a metal part on the chassis to discharge any static electricity.
4. Insert the NI 7340 motion controller into the PXI slot as shown in Figure 2-1. Use the injector/ejector handle to fully secure the device into place.

Figure 2-1. Installing an NI 73xx Motion Controller in a PXI Chassis

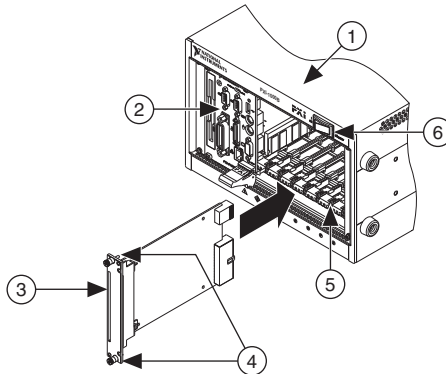

- | | |
|-----------------------------|-------------------------------|
| 1 PXI Chassis | 4 Front-Panel Mounting Screws |
| 2 PXI System Controller | 5 Module Guides |
| 3 NI 73xx Motion Controller | 6 Power Switch |

5. Attach the front panel of the NI 73xx motion controller to the front panel mounting rails of the chassis with the slot screws on the chassis.



Caution Make sure you have correctly connected all safety devices before you power on the motion system. Safety devices include inhibits, limit switches, and emergency shut down circuits.



Caution Always power on the computer containing the NI 7340 motion controller and initialize the controller before you power on the rest of the motion system. Power off the motion system in the reverse order.

6. Plug in and power on the chassis.

PCI Motion Controllers

1. Power off and unplug the computer.



Caution To protect yourself and the computer from electrical hazards, the computer *must* remain unplugged until the installation is complete.

2. Open the computer case to expose access to the PCI expansion slots.
3. Touch a metal part on the chassis to discharge any static electricity.
4. Choose an unused +3.3 V or +5 V PCI slot, and remove the corresponding expansion slot cover on the back panel of the computer.
5. Gently rock the controller into the slot. The connection may be tight, but do *not* force the controller into place.



Note Check that the bracket of the device aligns with the hole in the back panel rail of the computer chassis.

6. Secure the mounting bracket of the controller to the back panel rail of the computer.
7. Replace the cover.



Caution Make sure you have correctly connected all safety devices before you power on the motion system. Safety devices include inhibits, limit switches, and emergency shut down circuits.



Caution Always power on the computer containing the NI 7340 motion controller and then initialize the controller before you power on the rest of the motion system. Power off the motion system in the reverse order.

8. Plug in and power on the computer.

Hardware Overview

This chapter presents an overview of the National Instruments PXI/PCI-7340 hardware functionality.

Figures 3-1 and 3-2 show the NI PXI-7340 right and left sides, respectively.

Figure 3-1. NI PXI-7340 Right Side

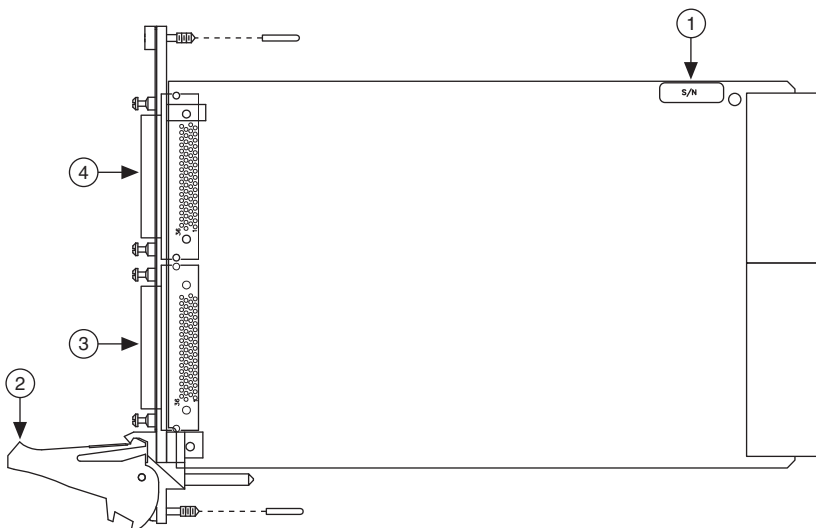

-
- | | |
|---|-------------------------|
| 1 | Serial Number Label |
| 2 | Injector/Ejector Handle |

- | | |
|---|------------------------------|
| 3 | 68-Pin Digital I/O Connector |
| 4 | 68-Pin Motion I/O Connector |
-

Figure 3-2. NI PXI-7340 Left Side

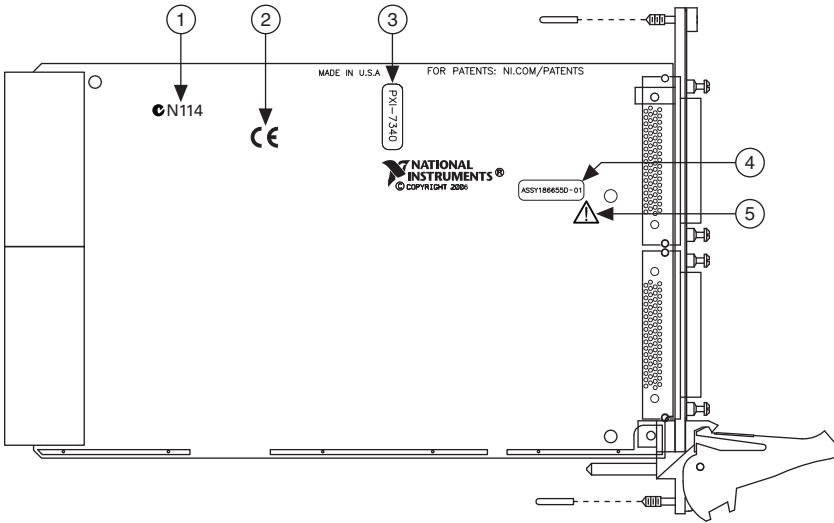

- 1 Identification Number Used in Australia
- 2 Symbol Indicating FFC Compliance
- 3 Board Type Label

- 4 Assembly Number Label
- 5 Symbol to Alert User to Read the Manual

Figure 3-3. NI PCI-7340 Parts Locator Diagram

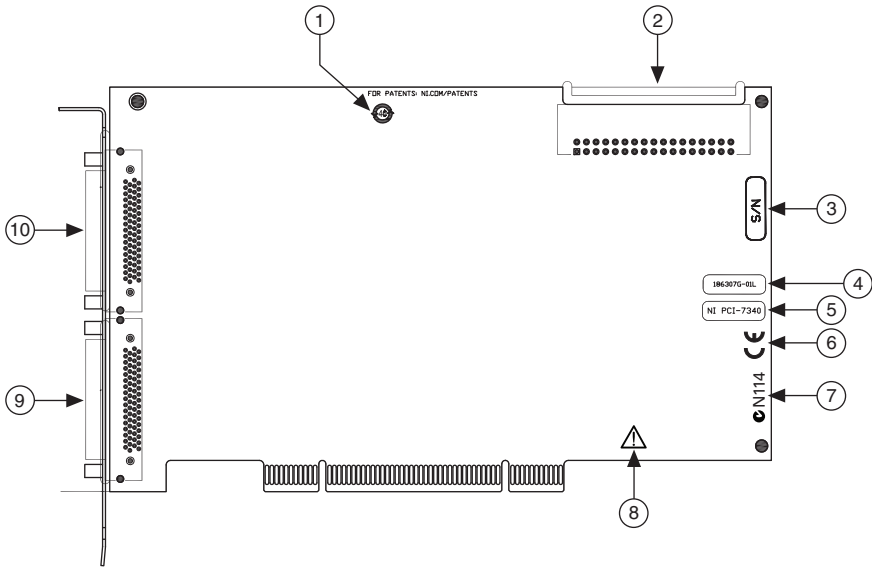

- | | |
|-------------------------|---|
| 1 RoHS Mark | 6 Symbol Indicating FFC Compliance |
| 2 RTSI Connector | 7 Identification Number Used in Australia |
| 3 Serial Number Label | 8 Symbol to Alert User to Read the Manual |
| 4 Assembly Number Label | 9 68-Pin Digital I/O Connector |
| 5 Board Type Label | 10 68-Pin Motion I/O Connector |

User Connectors

The 68-pin motion I/O connector provides all the signals for four axes of closed-loop motion control, including encoder feedback, limit and home inputs, breakpoint outputs, trigger inputs, digital-to-analog (DAC), and analog-to-digital (ADC) converter signals. Refer to Chapter 4, [Signal Connections](#), for details about the signals in the motion I/O connector.

The 68-pin digital I/O connector provides 32 bits of user-configurable digital I/O. Refer to Chapter 4, [Signal Connections](#), for details about the signals in the digital I/O connector.

The PCI-7340 RTSI connector provides up to eight triggers to facilitate synchronization between multiple National Instruments products. The PXI-7340 RTSI-enabled connection provides up to eight triggers and one PXI star trigger to facilitate synchronization between multiple National Instruments PXI-enabled products. Typical applications of the RTSI bus include triggering an image acquisition or DAQ measurement based on motion events, or capturing current motion positions based on events external to the motion controller. You can also use the RTSI bus for general hardware-based communication between RTSI devices.

The RTSI bus can also be used for general-purpose I/O. Refer to Chapter 4, [Signal Connections](#), for details about RTSI connector signals.

Functional Overview

This section provides an overview of motion control algorithms and the NI PXI/PCI-7340 controller.

Dual Processor Architecture

With the NI 7340 motion controller, you can perform up to four axes of simultaneous, coordinated motion control in a preemptive, multitasking, real-time environment.

An advanced dual-processor architecture that uses a 32-bit CPU combined with a digital signal processor (DSP) and custom FPGAs give the NI 7340 motion controller high-performance capabilities. The FIFO bus interface and powerful function set provide high-speed communications while off-loading complex motion functions from the host PC for optimized system performance.

The NI 7340 motion controller uses the DSP for all closed-loop control, including position tracking, PID control closed-loop computation, and motion trajectory generation. The DSP chip is supported by custom FPGAs that perform the high-speed encoder interfacing, position capture and breakpoint functions, motion I/O processing, and stepper pulse generation for hard real-time functionality.

The embedded CPU runs a multitasking, real-time operating system and handles host communications, command processing, multi-axis interpolation, error handling, general-purpose digital I/O, and overall motion system integration functions.

Embedded Real-Time Operating System (RTOS)

The embedded firmware is based on an embedded RTOS kernel and provides optimum system performance in varying motion applications. Motion tasks are prioritized. Task execution order depends on the priority of each task, the state of the entire motion system, I/O or other system events, and the real-time clock.

The DSP chip is a separate processor that operates independently from the CPU but is closely synchronized. The NI 7340 motion controller is a true multiprocessing and multitasking embedded controller.

The advanced architecture of the NI 7340 motion controller enables advanced motion features, such as enhanced PID functions. Refer to the *NI-Motion Help* for more information about the features available on the NI 7340 motion controller.

Trajectory Generators

The NI 7340 motion controller trajectory generators calculate the instantaneous position command that controls acceleration and velocity while it moves the axis to its target position. Depending on how you configure the axis, this command is then sent to the PID servo loop or stepper pulse generator.

To implement infinite trajectory control, the NI 7340 motion controller has eight trajectory generators implemented in the DSP chip (two per axis). Each generator calculates an instantaneous position for each PID update period. While simple point-to-point moves require only one trajectory generator, two simultaneous generators are required for blended moves and infinite trajectory control processing.

Analog Feedback

The NI 7340 motion controller has an 8-channel multiplexed, 12-bit ADC. The converted analog values are broadcast to both the DSP and CPU through a dedicated internal high-speed serial bus. The multiplexer provides the high sampling rates required for feedback loop closure, joystick inputs, or monitoring analog sensors. Refer to Appendix A, *Specifications*, for the multiplexer scan rate. Four of these channels are intended for calibration, leaving the other four available for analog feedback.

Flash Memory

Nonvolatile memory on the NI 7340 motion controller is implemented with flash ROM, which means that the controllers can electrically erase and reprogram their own ROM. Because all the NI 7340 motion controller embedded firmware, including the RTOS and DSP code, is stored in flash memory, you can upgrade the onboard firmware contents in the field for support and new feature enhancement.

Flash memory also allows objects such as programs and data arrays to be stored in non-volatile memory. It is possible to save the entire parameter state of the controller to the flash memory. On the next power cycle, the controller automatically loads and returns the configuration to these new saved default values.

The FPGA configuration programs also are stored in the flash ROM. At power-up, the FPGAs are booted with these programs, which means that updates to the FPGA programs can be performed in the field.

A flash memory download utility is included with the NI-Motion software that ships with the controller.

Axes and Motion Resources

The NI 7340 motion controller can control up to four axes of motion. The axes can be completely independent, simultaneously coordinated, or mapped in multidimensional groups called coordinate spaces. You can also synchronize coordinate spaces for multi-vector space coordinated motion control.

Axes

At a minimum, an axis consists of a trajectory generator, a PID (for servo axes) or stepper control block, and at least one output resource—either a DAC output (for servo axes) or a stepper pulse generator output. Servo axes must have either an encoder or ADC channel feedback resource.

Closed-loop stepper axes also require a feedback resource, while open-loop stepper axes do not. Figures 3-4 and 3-5 show these axis configurations.

With the NI 7340 motion controller, you can map one or two feedback resources and one or two output resources to the axis. An axis with its primary output resource mapped to a stepper output is by definition a stepper axis. An axis with its primary output resource mapped to a DAC is by definition a servo axis.

Figure 3-4. Servo Axis Resources

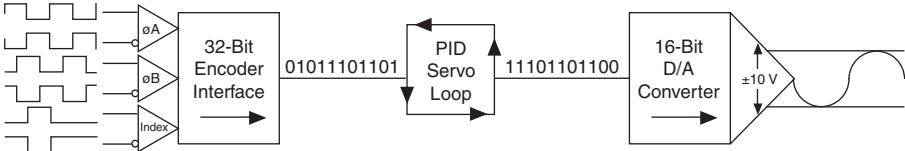
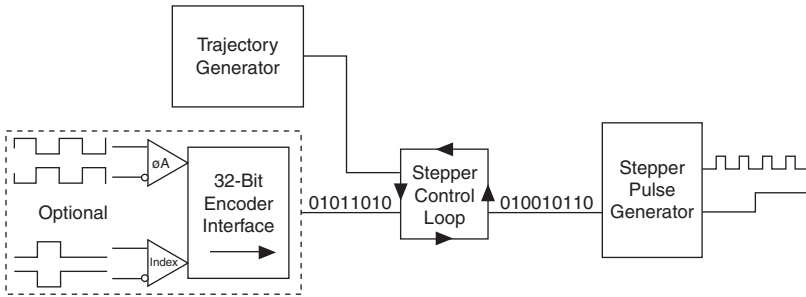

Figure 3-5. Stepper Axis Resources



The NI 7340 motion controller supports axes with secondary output resources, such as DACs for servo axes or stepper outputs. Defining two output resources is useful when controlling axes with multiple motors, such as gantry systems in which two DAC outputs can be configured with different torque limits and/or offsets.

The NI 7340 motion controller also supports secondary feedback resources, called encoders, for axes defined as servo. Two feedback resources are used when implementing dual-loop control, such as in backlash compensation, which reduces the number of encoders available for other axes.



Note Refer to the *NI-Motion Help* for information about configuring axes.

Motion Resources

Encoder, DAC, ADC, and motion I/O resources that are not used by an axis are available for non-axis or nonmotion-specific applications. You can directly control an unmapped DAC as a general-purpose analog output (± 10 V). Similarly, you can use any ADC channel to measure potentiometers or other analog sensors.

If an encoder resource is not needed for axis control, you can use it for any number of other functions, including position or velocity monitoring, as a digital potentiometer encoder input, or as a master encoder input for master/slave (electronic gearing) applications.

Each axis also has an associated forward and reverse limit input, a home input, a high-speed capture trigger input, a breakpoint output, and an inhibit output. These signals can be used for general-purpose digital I/O when not being used for their motion-specific purpose.

Onboard Programs and Buffers

The NI 7340 motion controller has full onboard programmability capable of executing up to 10 simultaneous motion programs.

You can execute the NI-Motion function set from onboard programs. In addition, the onboard programs support basic math and data operation functions for up to 120 general-purpose variables.

You can store and run onboard programs and buffers from RAM or save them to flash ROM. The NI 7340 motion controller has 64 KB of RAM and 128 KB of ROM that is divided into two 64 KB sectors for program and buffer storage. You can store and run programs and buffers from either RAM or ROM, but you cannot split programs between the two, and you cannot split programs or buffers between the two 64 KB ROM sectors.



Note Refer to the *NI-Motion Help* for detailed information about all of these onboard programming and buffer features.

Host Communications

The host computer communicates with the controller through a number of memory port addresses on the PCI or PXI host bus.

The primary bidirectional data transfer port supports FIFO data passing in both send and readback directions. The NI 7340 motion controller has both a command buffer for incoming commands and a return data buffer (RDB) for returning data.

The communications status register (CSR) provides bits for communications handshaking as well as real-time error reporting and general status feedback to the host PC. The move complete status (MCS) register provides instantaneous motion status of all axes.

Signal Connections

This chapter describes how to make input and output signal connections directly to the National Instruments PXI/PCI-7340 as well as general information about the associated I/O circuitry.

The NI 7340 motion controller has three connectors that handle all signals to and from the external motion system.

- 68-pin motion I/O connector
- 68-pin digital I/O connector
- RTSI connector

You can connect to your motion system with cables and accessories, varying from simple screw terminal blocks to enhanced Universal Motion Interface (UMI) units and drives.



Note The NI 7340 motion controller does not provide isolation between circuits.



Caution Turn off power to all devices when connecting or disconnecting the NI 7340 motion controller motion I/O and auxiliary digital I/O cables. Failure to do so may damage the controller.

Motion I/O Connector

The motion I/O connector contains all of the signals required to control up to four axes of servo and stepper motion, including the following features:

- Motor command analog and stepper outputs
- Encoder feedback inputs
- Forward, home, and reverse limit inputs
- Breakpoint outputs
- Trigger inputs
- Inhibit outputs

The motion I/O connector also contains four channels of 12-bit A/D inputs for analog feedback or general-purpose analog input.

Figure 4-1 shows the pin assignments for the 68-pin motion I/O connector on the NI 7340 motion controller. Table 4-1 includes descriptions for each of the signals. A line above a signal name indicates that the signal is active-low.

Figure 4-1. 68-Pin Motion I/O Connector Pin Assignment

Axis 1 Dir (CCW)	1	35	Axis 1 Step (CW)
Digital Ground	2	36	Axis 1 Encoder Phase A
Digital Ground	3	37	Axis 1 Encoder Phase B
Axis 1 Home Switch	4	38	Axis 1 Encoder Index
Trigger 1	5	39	Axis 1 Forward Limit Switch
Axis 1 Inhibit	6	40	Axis 1 Reverse Limit Switch
Axis 2 Dir (CCW)	7	41	Axis 2 Step (CW)
Digital Ground	8	42	Axis 2 Encoder Phase A
Digital Ground	9	43	Axis 2 Encoder Phase B
Axis 2 Home Switch	10	44	Axis 2 Encoder Index
Trigger 2	11	45	Axis 2 Forward Limit Switch
Axis 2 Inhibit	12	46	Axis 2 Reverse Limit Switch
Axis 3 Dir (CCW)	13	47	Axis 3 Step (CW)
Digital Ground	14	48	Axis 3 Encoder Phase A
Digital Ground	15	49	Axis 3 Encoder Phase B
Axis 3 Home Switch	16	50	Axis 3 Encoder Index
Trigger 3	17	51	Axis 3 Forward Limit Switch
Axis 3 Inhibit	18	52	Axis 3 Reverse Limit Switch
Axis 4 Dir (CCW)	19	53	Axis 4 Step (CW)
Digital Ground	20	54	Axis 4 Encoder Phase A
Digital Ground	21	55	Axis 4 Encoder Phase B
Axis 4 Home Switch	22	56	Axis 4 Encoder Index
Trigger 4	23	57	Axis 4 Forward Limit Switch
Axis 4 Inhibit	24	58	Axis 4 Reverse Limit Switch
Digital Ground	25	59	Host +5 V
Breakpoint 1	26	60	Breakpoint 2
Breakpoint 3	27	61	Breakpoint 4
Digital Ground	28	62	Shutdown
Analog Output 1	29	63	Analog Output 2
Analog Output 3	30	64	Analog Output 4
Analog Output Ground	31	65	Reserved
Analog Input 1	32	66	Analog Input 2
Analog Input 3	33	67	Analog Input 4
Analog Reference (Output)	34	68	Analog Input Ground

Table 4-1 describes the signals on the motion I/O connector.

Table 4-1. Motion I/O Signal Connections

Signal Name	Reference	Direction	Description
Axis <1..4> Dir (CCW)	Digital Ground	Output	Motor direction or counter-clockwise control
Axis <1..4> Step (CW)	Digital Ground	Output	Motor step or clockwise control
Axis <1..4> Encoder Phase A	Digital Ground	Input	Closed-loop only—phase A encoder input
Axis <1..4> Encoder Phase B	Digital Ground	Input	Closed-loop only—phase B encoder input
Axis <1..4> Encoder $\overline{\text{Index}}$	Digital Ground	Input	Closed-loop only—index encoder input
Axis <1..4> Home Switch	Digital Ground	Input	Home switch
Axis <1..4> Forward Limit Switch	Digital Ground	Input	Forward/clockwise limit switch
Axis <1..4> Reverse Limit Switch	Digital Ground	Input	Reverse/counter-clockwise limit switch
Axis <1..4> $\overline{\text{Inhibit}}$	Digital Ground	Output	Drive inhibit
Trigger <1..4>	Digital Ground	Input	High-speed position capture trigger input <1..4>
Breakpoint <1..4>	Digital Ground	Output	Breakpoint output <1..4>
Host +5 V	Digital Ground	Output	+5 V—host computer +5 V supply
Analog Input Ground	—	—	Reference for analog inputs
Analog Input <1..4>	Analog Input Ground	Input	12-bit analog input
Analog Output <1..4>	Analog Output Ground	Output	16-bit analog output
Analog Output Ground	—	—	Reference for analog outputs
Shutdown	Digital Ground	Input	Controlled device shutdown
Analog Reference (output)	Analog Input Ground	Output	+7.5 V—analog reference level
Digital Ground	—	—	Reference for digital I/O

Motion Axis Signals

The following signals control the servo amplifier or stepper driver.

- **Analog Output <1..4>**—These 16-bit DAC outputs are typically the servo command outputs for each axis. They can drive the industry-standard ± 10 V output, and can be software limited to any positive or negative voltage range. They also feature a software-programmable voltage offset.

Although typically used as the command output of an axis control loop, unused DACs can also function as independent analog outputs for general-purpose control.

- **Analog Output Ground**—To help keep digital noise separate from the analog DAC outputs, there is a separate return connection. Use this analog ground connection and not Digital Ground (digital I/O reference) as the reference for the DAC outputs when connecting to servo amplifiers.
- **Axis <1..4> Step (CW) and Dir (CCW)**—These open-collector signals are the stepper command outputs for each axis. The NI 7340 motion controller supports both major industry standards for stepper command signals: step and direction, or independent CW and CCW pulse outputs.

The output configuration and signal polarity is software programmable for compatibility with various third-party drives, as follows:

- When step and direction mode is configured, each commanded step (or microstep) produces a pulse on the step output. The direction output signal level indicates the command direction of motion, either forward or reverse.
- CW and CCW mode produces pulses (steps) on the CW output for forward-commanded motion and pulses on the CCW output for reverse-commanded motion.

In either case, you can set the active polarity of both outputs to active-low (inverting) or active-high (non-inverting). For example, with step and direction, you can make a logic high correspond to either forward or reverse direction.

The Step (CW) and Dir (CCW) outputs are driven by high-speed open-collector TTL buffers that feature 64 mA sink current capability and built-in 3.3 k Ω pull-up resistors to +5 V.



Caution Do *not* connect these outputs to anything other than a +5 V circuit. The output buffers will fail if subjected to voltages in excess of +5.5 V.

- **Axis <1..4> Inhibit**—Use the inhibit output signals to control the enable/inhibit function of a servo amplifier or stepper driver. When properly connected and configured, the inhibit function causes the connected motor to be de-energized and its shaft turns freely. These open-collector inhibit signals feature 64 mA current sink capability with built-in 3.3 k Ω pull-up resistors to +5 V, and can directly drive most driver/amplifier inhibit input circuits.

While the industry standard for inhibits is active-low (inverting), these outputs have programmable polarity and can be set to active-high (non-inverting) for increased flexibility and unique drive compatibility.

Inhibit output signals can be activated automatically upon a shutdown condition, a Kill Motion command, or any motion error that causes a kill motion condition, such as following error trip. You can also directly control the inhibit output signals to enable or disable a driver or amplifier.

Step, Direction, and Inhibit Output Circuit

The NI 7340 motion controller provides single-ended step, direction, and inhibit output signals. To connect the NI 7340 to drives with opto-isolated inputs, connect as shown in Figure 4-2. If the optocoupler does not include its own current-limiting resistor, you must provide an external resistor in series with the NI 7340 output, as shown.



Caution To prevent damage to the NI 7340 or other motion hardware, use a resistor that limits the current to a value below the maximum specifications of the controller and other hardware.

Figure 4-2. Step, Direction, and Inhibit Output Circuit

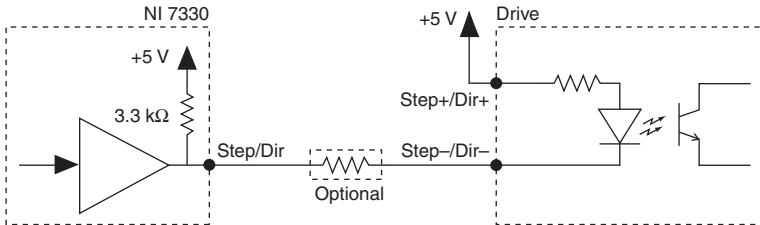

Limit and Home Inputs

The following signals control limit and home inputs.

- Axis <1..4> Forward Limit Input
- Axis <1..4> Home Input
- Axis <1..4> Reverse Limit Input

These inputs are typically connected to limit switches located at physical ends of travel and/or at a specific home position. Limit and home inputs can be software enabled or disabled at any time. When enabled, an active transition on a limit or home input causes a full torque halt stop of the associated motor axis. In addition, an active forward or reverse limit input impedes future commanded motion in that direction for as long as the signal is active.



Note By default, limit and home inputs are digitally filtered and must remain active for at least 1 ms to be recognized. You can use MAX to disable digital filtering for limit and home inputs. Active signals should remain active to prevent motion from proceeding further into the limit. Pulsed limit signals stop motion, but they do not prevent further motion in that direction if another move is started.

The input polarity of these signals is software programmable for active-low (inverting) or active-high (non-inverting).

You can use software disabled limit and home inputs as general-purpose inputs. You can read the status of these inputs at any time and set and change their polarity as required.

Limit and home inputs are a per axis enhancement on the NI 7340 motion controller and are not required for basic motion control. These inputs are part of a system solution for complete motion control.



Caution National Instruments recommends using limits for personal safety, as well as to protect the motion system.

Wiring Concerns

For the end of travel limits to function correctly, the forward limit must be located at the forward or positive end of travel, and the reverse limit at the negative end of travel.



Caution Failure to follow these guidelines may result in motion that stops at, but then travels through, a limit, potentially damaging the motion system. Miswired limits may prevent motion from occurring at all.

Keep limit and home switch signals and their ground connections wired separately from the motor driver/amplifier signal and encoder signal connections.



Caution Wiring these signals near each other can cause faulty motion system operation due to signal noise and crosstalk.

Limit and Home Input Circuit

By default, all limit and home inputs are digitally filtered and must be active for at least 1 ms. You can use MAX to disable digital filtering for limit and home inputs. Figure 4-3 shows a simplified schematic diagram of the circuit used by the limit and home switch inputs for input signal buffering and detection.

Figure 4-3. Limit and Home Input Circuit

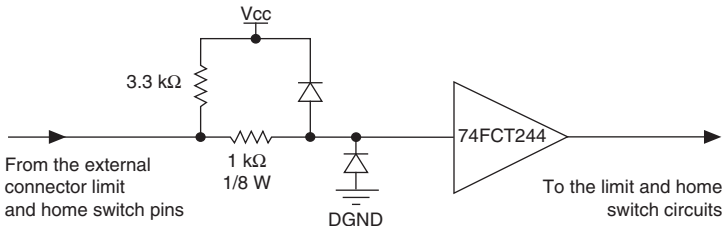



Note Prior to board revision 186307G-01L, the internal resistor value on the encoder input circuit was 1 k Ω . Figures 3-2 and 3-3 show the location of the part number label on PXI and PCI boards, respectively. For earlier versions of the NI 7340, refer to the *NI 7340 User Manual and Specifications* document, 370838A-01, November 2003 revision.



Caution Excessive input voltages can cause erroneous operation and/or component failure. Verify that the input voltage is within the specification range.

Encoder Signals

The NI 7340 motion controller offers four channels of single-ended quadrature encoder inputs. All National Instruments power drives and UMI accessories provide built-in circuitry that converts differential encoder signals to single-ended encoder signals. Each channel consists of a Phase A, Phase B, and Index input, as described in the following sections.

Encoder <1..4> Phase A/Phase B

The encoder inputs provide position and velocity feedback for absolute and relative positioning of axes in any motion system configuration.

If an encoder resource is not needed for axis control, it is available for other functions including position or velocity monitoring, digital potentiometer encoder inputs, or as a master encoder input for master/slave (electronic gearing) applications.

The encoder channels (Encoder <1..4>) are implemented in an FPGA and are high performance with extended input frequency response and advanced features, such as high-speed position capture inputs and breakpoint outputs.

An encoder input channel converts quadrature signals on Phase A and Phase B into 32-bit up/down counter values. Quadrature signals are generated by optical, magnetic, laser, or electronic devices that provide two signals, Phase A and Phase B, that are 90° out of phase. The leading phase, A or B, determines the direction of motion. The four transition states of the relative signal phases provide distinct pulse edges that cause count up or count down pulses in the direction determined by the leading phase.

A typical encoder with a specification of N (N = number) lines per unit of measure (revolutions or linear distance) produces $4 \times N$ quadrature counts per unit of measure. The count is the basic increment of position in NI-Motion systems.



Tip Determine quadrature counts by multiplying the encoder resolution in encoder lines by four. The encoder resolution is the number of encoder lines between consecutive encoder marker or Z-bit indexes. If the encoder does not have an index output, the resolution is referred to as lines per revolution, or lines per unit of measure, such as inch, centimeter, millimeter, and so on.

Encoder <1..4> Index (Phase Z)

The Index input is primarily used to establish a reference position. This function uses the number of counts per revolution or the linear distance to initiate a search move that locates the index position. When a valid Index signal transition occurs during a Find Reference routine, the position of the Index signal is captured accurately. Use this captured position to establish a reference zero position for absolute position control or any other motion system position reference required.

The default MAX settings guarantee that the Find Index routine completes successfully if the encoder generates a high index pulse when phases A and B are low and the encoder is connected through an NI UMI or drive accessory. Figure 4-4 shows the default encoder phasing diagram at the inputs to the controller.

Figure 4-4. Quadrature Encoder Phasing Diagram

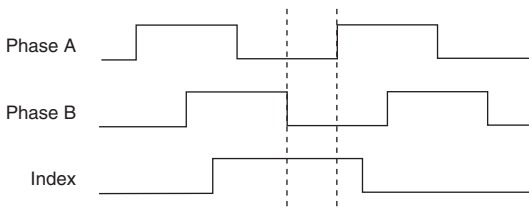

You can set the index reference criteria in MAX to change the pattern of phases A and B for the index search. You can also set the encoder polarity for phases A, B, and Z in MAX.

Wiring Concerns

The encoder inputs are connected to quadrature decoder/counter circuits. It is very important to minimize noise at this interface. Excessive noise on these encoder input signals may result in loss of counts or extra counts and erroneous closed-loop motion operation. Verify the encoder connections before powering up the system.



Caution Wire encoder signals and their ground connections separately from all other connections. Wiring these signals near the motor drive/amplifier or other signals can cause positioning errors and faulty operation.

Encoders with differential line driver outputs are strongly recommended for all applications and must be used if the encoder cable length is longer than 3.05 m (10 ft). Shielded, 24 AWG wire is the minimum recommended size for the encoder cable. Cables with twisted pairs and an overall shield are recommended for optimized noise immunity.

All National Instruments power drives and UMI accessories provide built-in circuitry that converts differential encoder signals to single-ended encoder signals.



Caution Unshielded cable can cause noise to corrupt the encoder signals, resulting in lost counts and reduced motion system accuracy.

Encoder Input Circuit

Figure 4-5 shows a simplified schematic diagram of the circuit used for the Phase A, Phase B, and Index encoder inputs. Both phases A and B are required for proper encoder counter operation, and the signals must support the 90° phase difference within system tolerance. The encoder and Index signals are conditioned by a software-programmable digital filter inside the FPGA. The Index signal is optional but highly recommended and required for initialization functionality with the Find Index function.

Figure 4-5. Encoder Input Circuit

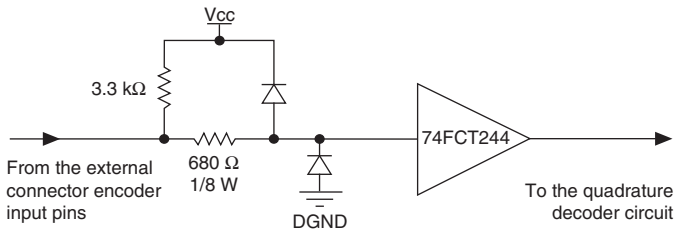

Trigger Inputs, Shutdown Input, and Breakpoint Outputs

The NI 7340 motion controller offers additional high-performance features in the encoder FPGA. The encoder channels have high-speed position capture trigger inputs and breakpoint outputs. These signals are useful for high-speed synchronization of motion with actuators, sensors, and other parts of the complete motion system:

- **Trigger Input <1..4>**—When enabled, an active transition on a high-speed position capture input causes instantaneous position capture of the corresponding encoder count value. You can use this high-speed position capture functionality for applications ranging from simple position tagging of sensor data to complex camming systems with advance/retard positioning and registration. An available NI 7340 motion controller position mode is to move an axis Relative to Captured Position.

The polarity of the trigger input is programmable in software as active-low (inverting) or active-high (non-inverting), rising or falling edge. You can also use a trigger input as a latching general-purpose digital input by simply ignoring the captured position.

- **Shutdown Input**—When enabled in software, the shutdown input signal can be used to kill all motion by asserting the controller inhibits, setting the analog outputs to 0 V, and stopping any stepper pulse generation. To activate shutdown, the signal must transition from a low to a high state, or rising edge.
- **Breakpoint Output <1..4>**—A breakpoint output can be programmed to transition when the associated encoder value equals the breakpoint position. You can use a breakpoint output to directly control actuators or as a trigger to synchronize data acquisition or other functions in the motion control system.

You can program breakpoints as *absolute*, *modulo*, or *relative* positions. Breakpoint outputs can be preset to a known state so that the transition when the breakpoint occurs can be low to high, high to low, or toggle.

The breakpoint outputs are driven by open-collector TTL buffers that feature 64 mA sink current capability and built-in 3.3 kΩ pull-up resistors to +5 V.

You can directly set and reset breakpoint outputs to use them as general-purpose digital outputs.



Note Breakpoint outputs and trigger inputs require an encoder connection.

Wiring Concerns



Caution Keep trigger input, shutdown input, and breakpoint output signals and their ground connections wired separately from the motor driver/amplifier signal and encoder signal connections. Wiring these signals near each other can cause faulty operation.



Caution Excessive input voltages can cause erroneous operation and/or component failure.

Trigger Input, Shutdown Input, and Breakpoint Output Circuits

Figures 4-6, 4-7, and 4-8 show a simplified schematic diagram of the circuits used by the trigger inputs, shutdown inputs, and breakpoint outputs for signal buffering.

Figure 4-6. Trigger Input Circuit

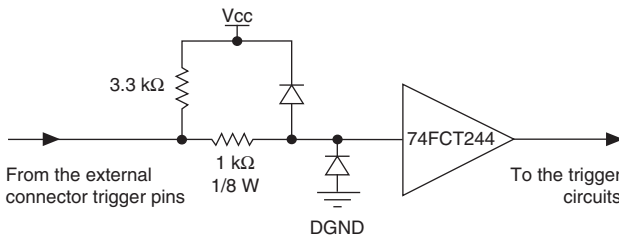

Figure 4-7. Shutdown Input Circuit

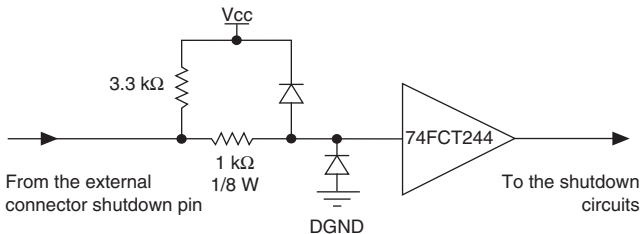
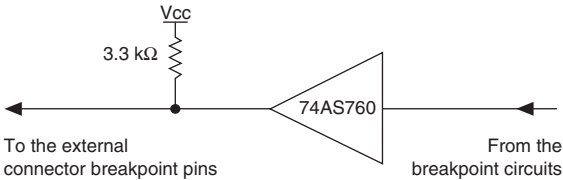

Figure 4-8. Breakpoint Output Circuit



Analog Inputs

The NI 7340 motion controller has the following ADC input signals:

- **Analog Input <1..4>**—The NI 7340 motion controller includes an eight-channel multiplexed, 12-bit ADC capable of measuring ± 10 V, ± 5 V, 0 to 10 V, and 0 to 5 V inputs. ADC channels 1 through 4 are brought out externally on the 68-pin motion I/O connector. ADC channels 5 through 8 are connected internally, as shown in Table 4-2. These signals can be used for ADC test and system diagnostics.

Table 4-2. Internal ADC Channels

ADC Input	Signal
5	Filtered +5 V
6	Floating (NC)
7	Analog Reference (7.5 V)
8	Analog Input Ground

You can configure each ADC channel for motion feedback, simple A/D conversion, or both.

You can read the digital value of analog voltage on any of the eight ADC channels of the controller. Table 4-3 shows the range of values read back and the voltage resolution for each setting. The voltage resolution is in volts per least significant bit (V/LSB).

Table 4-3. Analog Input Voltage Ranges

Input Range	Binary Values	Resolution
± 10 V	-2,048 to 2,047	0.0049 V/LSB
± 5 V	-2,048 to 2,047	0.0024 V/LSB
0 to 10 V	0 to 4,095	0.0024 V/LSB
0 to 5 V	0 to 4,095	0.0012 V/LSB

As indicated in Table 4-3, when configured as analog feedback, an analog sensor acts like a limited range absolute position device with a full-scale position range. You can map any ADC channel as feedback to any axis.

You can enable and disable individual ADC channels in software. Disable unused ADC channels for the highest multiplexer scan rate performance. Properly enabled, the scan rate is high enough to support analog feedback at the highest PID sample rate.

- **Analog Reference**—For convenience, 7.5 V (nominal) analog reference voltage is available. You can use this output as a low-current supply to sensors that require a stable reference. Refer to Appendix A, *Specifications*, for analog reference voltage specifications.
- **Analog Input Ground**—To help keep digital noise out of the analog input, a separate return connection is available. Use this reference ground connection and not Digital Ground (digital I/O reference) or Analog Output Ground as the reference for the analog inputs.



Tip Refer to the *Measuring Floating (Nonreferenced) Sources* section of the *Field Wiring and Noise Considerations for Analog Signals* NI Developer Zone document at ni.com/zone for more information about analog input connections.

Wiring Concerns

For proper use of each ADC input channel, the analog signal to be measured should be connected to the channel input and its ground reference connected to the Analog Input Ground.



Note The analog reference output is an output signal only and must not connect to an external reference voltage. Connect the common of the external reference to the Analog Input Ground pin for proper A/D reference and improved voltage measurement.

Other Motion I/O Connection

The NI 7340 motion controller provides Host +5 V, which is the internal +5 V supply of the host computer. It is typically used to detect when the host computer is powered and to shut down external motion system components when the host computer is turned off or disconnected from the motion accessory.



Caution The host +5 V signal is limited to <100 mA and should not be used to power any external devices, except those intended in the host bus monitor circuits on the UMI and drive products.

Digital I/O Connector

All the general-purpose digital I/O lines on the NI 7340 motion controller are available on a separate 68-pin digital I/O connector. Figure 4-9 shows the pin assignments for this connector.

Figure 4-9. 68-Pin Digital I/O Connector Pin Assignments

+5 V	1	35	Digital Ground
PCLK	2	36	Digital Ground
Reserved	3	37	Digital Ground
Reserved	4	38	DPull
PWM1	5	39	Digital Ground
Reserved	6	40	Reserved
Reserved	7	41	Digital Ground
Reserved	8	42	Digital Ground
PWM2	9	43	Digital Ground
Port 1:bit 0	10	44	Port 1:bit 1
Digital Ground	11	45	Port 1:bit 2
Port 1:bit 3	12	46	Digital Ground
Port 1:bit 4	13	47	Port 1:bit 5
Digital Ground	14	48	Port 1:bit 6
Port 1:bit 7	15	49	Digital Ground
Port 2:bit 0	16	50	Digital Ground
Port 2:bit 1	17	51	Port 2:bit 2
Digital Ground	18	52	Port 2:bit 3
Digital Ground	19	53	Port 2:bit 4
Digital Ground	20	54	Port 2:bit 5
Port 2:bit 6	21	55	Digital Ground
Port 2:bit 7	22	56	Digital Ground
Port 3:bit 0	23	57	Port 3:bit 1
Digital Ground	24	58	Port 3:bit 2
Port 3:bit 3	25	59	Digital Ground
Port 3:bit 4	26	60	Port 3:bit 5
Digital Ground	27	61	Port 3:bit 6
Port 3:bit 7	28	62	Digital Ground
Port 4:bit 0	29	63	Port 4:bit 1
Digital Ground	30	64	Port 4:bit 2
Port 4:bit 3	31	65	Digital Ground
Port 4:bit 4	32	66	Port 4:bit 5
Digital Ground	33	67	Port 4:bit 6
Port 4:bit 7	34	68	Digital Ground

The 32-bit digital I/O port is configured in hardware as four 8-bit digital I/O ports. The bits in a port are typically controlled and read with byte-wide bitmapped commands.

All digital I/O lines have programmable direction and polarity. Each output circuit can sink and source 24 mA.

The DPull pin controls the state of the input pins at power-up. Connecting DPull to +5 V or leaving it unconnected configures all pins in all ports for 100 kΩ pull-ups. Connecting DPull to ground configures the ports for 100 kΩ pull-downs.

PWM Features

The NI 7340 motion controller provides two pulse width modulation (PWM) outputs on the digital I/O connector. The PWM outputs generate periodic waveforms whose period and duty cycles can be independently controlled through software commands. The PWM is comparable to a digital representation of an analog value because the duty cycle is directly proportional to the expected output value. PWM outputs are typically used for transmitting an analog value through an optocoupler. A simple lowpass filter turns a PWM signal back into its corresponding analog value. You have the option to use the PCLK input instead of the internal source as the clock for the PWM generators.



Note These signals are configured in software and are in no way associated with the PID servo control loop. Refer to the *NI-Motion Help* for more information.

RTSI Connector

The physical RTSI bus interface varies depending on the type of NI 7340 motion controller.

The PXI-7340 uses the PXI chassis backplane to connect to other RTSI-capable devices.

The PCI-7340 uses a ribbon cable to connect to other RTSI-capable PCI devices.

RTSI Signal Considerations

The NI 7340 motion controller motion controller allows you to use up to eight RTSI trigger lines as sources for trigger inputs, or as destinations for breakpoint outputs and encoder signals. The RTSI trigger lines can also serve as a generic digital I/O port. The RTSI star trigger line can be used only for a trigger input. Breakpoint outputs are output-only signals that generate an active-high pulse of 200 ns duration, as shown in Figure 4-10.

Figure 4-10. Breakpoint across RTSI

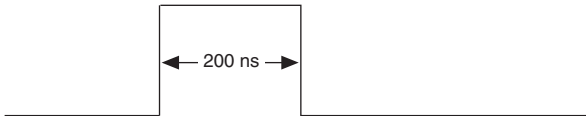

Encoder and Index signals are output-only signals across RTSI that are the digitally-filtered versions of the raw signals coming into the controller. If you are using the RTSI bus for trigger inputs or generic digital I/O, all signals are passed through unaltered.

Specifications

This appendix lists the hardware and software performance specifications for the National Instruments PXI/PCI-7340. Hardware specifications are typical at 25 °C, unless otherwise stated.

Servo Performance

PID update rate range	62.5 μ s to 5 ms/sample
Maximum PID update rate	62.5 μ s/axis
4-axis PID update rate	250 μ s total
Multi-axis synchronization	<1 update sample
Double-buffered trajectory parameters	
Absolute position range	$\pm 2^{31}$ counts
Maximum relative move size	$\pm 2^{31}$ counts
Velocity range	1 to $\pm 20,000,000$ counts/s
Acceleration/deceleration ¹	244 to 512,000,000 counts/s ² at a PID update rate of 250 μ s
S-Curve time range	1 to 32,767 samples
Following error range	1 to 32,767 counts and disabled
Gear ratio	$\pm 32,767:1$ to $\pm 1:32,767$
Servo control loop modes	
PID (Kp, Ki, and Kd) gains	0 to 32,767
Integration limit (Ilim)	0 to 32,767
Derivative sample period (Td)	1 to 63 samples
Feedforward (Aff, Vff) gains	0 to 32,767
Velocity feedback (Kv) gain	0 to 32,767
Servo command analog outputs	
Voltage range	± 10 V
Resolution	16 bits (0.000305 V/LSB)
Programmable torque (velocity) limits	
Positive limit	± 10 V (-32,768 to +32,767)
Negative limit	± 10 V (-32,768 to +32,767)
Programmable offset	± 10 V (-32,768 to +32,767)

¹ Refer to the *NI-Motion Help* for more information.

Stepper Performance

Trajectory update rate range	62.5 to 500 μ s/sample
Maximum update rate	62.5 μ s/axis
4-axis update rate	250 μ s total
Multi-axis synchronization	<1 update sample
Double-buffered trajectory parameters	
Position range	$\pm 2^{31}$ steps
Maximum relative move size.....	$\pm 2^{31}$ steps
Velocity range	1 to 4,000,000 steps/s
Acceleration/deceleration ¹	244 to 512,000,000 counts/s ² at a PID update rate of 250 μ s
S-Curve time range	1 to 32,767 samples
Following error range	0 to 32,767 counts
Gear ratio	$\pm 32,767:1$ to $\pm 1:32,767$
Stepper outputs	
Maximum pulse rate	4 MHz (full, half, and microstep)
Minimum pulse width	120 ns at 4 MHz
Step output mode	Step and direction or CW/CCW
Voltage range	0 to 5 V
Output low voltage.....	<0.6 V at 64 mA sink
Output high voltage	Open collector with built-in 3.3 k Ω pull-up to +5 V
Polarity	Programmable, active-high or active-low

System Safety

Watchdog timer function.....	Resets board to startup state
Watchdog timeout	63 ms
Shutdown input	
Voltage range	0 to 5 V
Input low voltage	0.8 V
Input high voltage	2 V
Polarity	Rising edge
Control	Disable all axes and command outputs

Motion I/O

Encoder inputs	Quadrature, incremental, single-ended
Maximum count rate	20 MHz
Minimum pulse width	Programmable; depends on digital filter settings

¹ Refer to the *NI-Motion Help* for more information.

Voltage range	0 to 5 V
Input low voltage	0.8 V
Input high voltage	2 V
Minimum index pulse width	Programmable; depends on digital filter settings
Maximum resolution	2 ²⁸ - 1, programmable

Forward, reverse, and home inputs

Number of inputs	12 (3 per axis)
Voltage range	0 to 5 V
Input low voltage	0.8 V
Input high voltage	2 V
Polarity	Programmable, active-high or active-low
Minimum pulse width	1 ms with filter enabled; 60 ns without filter enabled
Control	Individual enable/disable, stop on input, prevent motion, Find Home

Trigger inputs

Number of inputs	4 (Encoders 1 through 4)
Voltage range	0 to 5 V
Input low voltage	0.8 V
Input high voltage	2 V
Polarity	Programmable, active-high or active-low
Minimum pulse width	100 ns
Capture latency	<100 ns
Capture accuracy	1 count
Maximum repetitive capture rate	100 Hz

Breakpoint outputs

Number of outputs	4 (Encoders 1 through 4)
Voltage range	0 to 5 V
Output low voltage	<0.6 V at 64 mA sink
Output high voltage	Open collector with built-in 3.3 k Ω pull-up to +5 V
Polarity	Programmable, active-high or active-low
Maximum repetitive breakpoint rate	100 Hz

Inhibit/enable output

Number of outputs	4 (1 per-axis)
Voltage range	0 to 5 V
Output low voltage	<0.6 V at 64 mA sink
Output high voltage	Open collector with built-in 3.3 k Ω pull-up to +5 V
Polarity	Programmable, active-high or active-low
Control	MustOn/MustOff or automatic when axis off

Analog inputs

Number of inputs	8, multiplexed, single ended
Number for user signals	4
Number for system diagnostics	4
Voltage range (programmable)	Programmable: ± 10 V, ± 5 V, 0 to 10 V, 0-5 V
Input coupling	DC
Input resistance	10 k Ω min
Resolution	12 bits, no missing codes
Monotonicity	Guaranteed
Multiplexor scan rate	25 μ s/enabled channel

Analog outputs

Number of outputs	4, single ended
Output coupling	DC
Voltage range	± 10 V
Output current	± 5 mA
Resolution	16 bits, no missing codes
Monotonic	Guaranteed
Analog reference output	7.5 V (nominal) @ 5 mA

Digital I/O

Ports	4, 8-bit ports
Line direction	Individual bit programmable

Inputs

Voltage range	0 to 5 V
Input low voltage	0.8 V
Input high voltage	2.0 V
Polarity	Programmable, active-high or active-low

Outputs

Voltage range	0 to 5 V
Output low voltage	<0.45 V at 24 mA sink
Output high voltage	>2.4 V at 24 mA source
Polarity	Programmable, active-high or active-low

PWM outputs

Number of PWM outputs	2
Maximum PWM frequency	50 kHz
Resolution	8-bit
Duty cycle range	0 to (255/256)%
Clock sources	Internal or external

RTSI

Trigger lines	8
---------------------	---

Maximum Power Requirements

+5 V ($\pm 5\%$)	1 A
+12 V ($\pm 5\%$)	30 mA
-12 V ($\pm 10\%$)	30 mA
Power consumption	5.7 W

Physical

Dimensions (Not Including Connectors)

PXI-7340	16 × 10 cm (6.3 × 3.9 in.)
PCI-7340	17.5 × 9.9 cm (6.9 × 3.9 in.)

Connectors

Motion I/O connector	68-pin female high-density VHDCI type
32-bit digital I/O connector	68-pin female high-density VHDCI type

Weight

PXI-7340	170 g (6 oz)
PCI-7340	113 g (4 oz)



Caution Clean the hardware with a soft, nonmetallic brush. Make sure that the hardware is completely dry and free from contaminants before returning it to service.

Maximum Working Voltage

Channel-to-earth	12 V, Installation Category I (signal voltage plus common-mode voltage)
Channel-to-channel	22 V, Installation Category I (signal voltage plus common-mode voltage)



Caution These values represent the maximum allowable voltage between any accessible signals on the controller. To determine the acceptable voltage range for a particular signal, refer to the individual signal specifications.



Caution The protection provided by the NI 7330 can be impaired if it is used in a manner not described in this document.

Environment

Operating temperature	0 to 55 °C
Storage temperature	-20 to 70 °C
Humidity	10 to 90% RH, noncondensing

Maximum altitude.....	2,000 m
Pollution Degree	2

Indoor use only.

Safety

This product meets the requirements of the following standards of safety for electrical equipment for measurement, control, and laboratory use:

- IEC 61010-1, EN 61010-1
- UL 61010-1, CSA 61010-1



Note For UL and other safety certifications, refer to the product label or the [Online Product Certification](#) section.

Electromagnetic Compatibility

This product meets the requirements of the following EMC standards for electrical equipment for measurement, control, and laboratory use:

- EN 61326-1 (IEC 61326-1): Class A emissions; Basic immunity
- EN 55011 (CISPR 11): Group 1, Class A emissions
- EN 55022 (CISPR 22): Class A emissions
- EN 55024 (CISPR 24): Immunity
- AS/NZS CISPR 11: Group 1, Class A emissions
- AS/NZS CISPR 22: Class A emissions
- FCC 47 CFR Part 15B: Class A emissions
- ICES-001: Class A emissions



Note In the United States (per FCC 47 CFR), Class A equipment is intended for use in commercial, light-industrial, and heavy-industrial locations. In Europe, Canada, Australia and New Zealand (per CISPR 11) Class A equipment is intended for use only in heavy-industrial locations.



Note Group 1 equipment (per CISPR 11) is any industrial, scientific, or medical equipment that does not intentionally generate radio frequency energy for the treatment of material or inspection/analysis purposes.



Note For EMC declarations and certifications, and additional information, refer to the [Online Product Certification](#) section.

CE Compliance

This product meets the essential requirements of applicable European Directives as follows:

- 2006/95/EC; Low-Voltage Directive (safety)
- 2004/108/EC; Electromagnetic Compatibility Directive (EMC)

Online Product Certification

To obtain product certifications and the Declaration of Conformity (DoC) for this product, visit ni.com/certification, search by model number or product line, and click the appropriate link in the Certification column.

Environmental Management

NI is committed to designing and manufacturing products in an environmentally responsible manner. NI recognizes that eliminating certain hazardous substances from our products is beneficial to the environment and to NI customers.

For additional environmental information, refer to the *Minimize Our Environmental Impact* web page at ni.com/environment. This page contains the environmental regulations and directives with which NI complies, as well as other environmental information not included in this document.

Waste Electrical and Electronic Equipment (WEEE)



EU Customers At the end of the product life cycle, all products *must* be sent to a WEEE recycling center. For more information about WEEE recycling centers, National Instruments WEEE initiatives, and compliance with WEEE Directive 2002/96/EC on Waste and Electronic Equipment, visit ni.com/environment/weee.

电子信息产品污染控制管理办法（中国 RoHS）



中国客户 National Instruments 符合中国电子信息产品中限制使用某些有害物质指令 (RoHS)。关于 National Instruments 中国 RoHS 合规性信息，请登录 ni.com/environment/rohs_china。(For information about China RoHS compliance, go to ni.com/environment/rohs_china.)

Cable Connector Descriptions

This appendix describes the connector pinout for the cables that connect to the PXI/PCI-7340.

Figures B-1 and B-2 show the pin assignments for the stepper and servo 50-pin motion connectors. These connectors are available when you use the SH68-C68-S shielded cable assembly and the 68M-50F step/servo bulkhead cable adapter.

Figure B-1. 50-Pin Stepper Connector Pin Assignment

Axis 1 Dir (CCW)	1	2	Axis 1 Step (CW)
Digital Ground	3	4	Axis 1 Encoder Phase A
Digital Ground	5	6	Axis 1 Encoder Phase B
Axis 1 Home Switch	7	8	Axis 1 Encoder $\overline{\text{Index}}$
Trigger/Breakpoint 1	9	10	Axis 1 Forward Limit Switch
Axis 1 Inhibit	11	12	Axis 1 Reverse Limit Switch
Axis 2 Dir (CCW)	13	14	Axis 2 Step (CW)
Digital Ground	15	16	Axis 2 Encoder Phase A
Digital Ground	17	18	Axis 2 Encoder Phase B
Axis 2 Home Switch	19	20	Axis 2 Encoder $\overline{\text{Index}}$
Trigger/Breakpoint 2	21	22	Axis 2 Forward Limit Switch
Axis 2 Inhibit	23	24	Axis 2 Reverse Limit Switch
Axis 3 Dir (CCW)	25	26	Axis 3 Step (CW)
Digital Ground	27	28	Axis 3 Encoder Phase A
Digital Ground	29	30	Axis 3 Encoder Phase B
Axis 3 Home Switch	31	32	Axis 3 Encoder $\overline{\text{Index}}$
Trigger/Breakpoint 3	33	34	Axis 3 Forward Limit Switch
Axis 3 Inhibit	35	36	Axis 3 Reverse Limit Switch
Axis 4 Dir (CCW)	37	38	Axis 4 Step (CW)
Digital Ground	39	40	Axis 4 Encoder Phase A
Digital Ground	41	42	Axis 4 Encoder Phase B
Axis 4 Home Switch	43	44	Axis 4 Encoder $\overline{\text{Index}}$
Trigger/Breakpoint 4	45	46	Axis 4 Forward Limit Switch
Axis 4 Inhibit	47	48	Axis 4 Reverse Limit Switch
Digital Ground	49	50	Host +5 V

Figure B-2. 50-Pin Servo Connector Pin Assignment

Analog Output Ground	1	2	Analog Output 1
Digital Ground	3	4	Axis 1 Encoder Phase A
Digital Ground	5	6	Axis 1 Encoder Phase B
Axis 1 Home Switch	7	8	Axis 1 Encoder Index
Trigger/Breakpoint 1	9	10	Axis 1 Forward Limit Switch
Axis 1 Inhibit	11	12	Axis 1 Reverse Limit Switch
Analog Output Ground	13	14	Analog Output 2
Digital Ground	15	16	Axis 2 Encoder Phase A
Digital Ground	17	18	Axis 2 Encoder Phase B
Axis 2 Home Switch	19	20	Axis 2 Encoder Index
Trigger/Breakpoint 2	21	22	Axis 2 Forward Limit Switch
Axis 2 Inhibit	23	24	Axis 2 Reverse Limit Switch
Analog Output Ground	25	26	Analog Output 3
Digital Ground	27	28	Axis 3 Encoder Phase A
Digital Ground	29	30	Axis 3 Encoder Phase B
Axis 3 Home Switch	31	32	Axis 3 Encoder Index
Trigger/Breakpoint 3	33	34	Axis 3 Forward Limit Switch
Axis 3 Inhibit	35	36	Axis 3 Reverse Limit Switch
Analog Output Ground	37	38	Analog Output 4
Digital Ground	39	40	Axis 4 Encoder Phase A
Digital Ground	41	42	Axis 4 Encoder Phase B
Axis 4 Home Switch	43	44	Axis 4 Encoder Index
Trigger/Breakpoint 4	45	46	Axis 4 Forward Limit Switch
Axis 4 Inhibit	47	48	Axis 4 Reverse Limit Switch
Digital Ground	49	50	Host +5 V

Technical Support and Professional Services

Log in to your National Instruments ni.com User Profile to get personalized access to your services. Visit the following sections of ni.com for technical support and professional services:

- **Support**—Technical support at ni.com/support includes the following resources:
 - **Self-Help Technical Resources**—For answers and solutions, visit ni.com/support for software drivers and updates, a searchable KnowledgeBase, product manuals, step-by-step troubleshooting wizards, thousands of example programs, tutorials, application notes, instrument drivers, and so on. Registered users also receive access to the NI Discussion Forums at ni.com/forums. NI Applications Engineers make sure every question submitted online receives an answer.
 - **Standard Service Program Membership**—This program entitles members to direct access to NI Applications Engineers via phone and email for one-to-one technical support, as well as exclusive access to self-paced online training modules at ni.com/self-paced-training. All customers automatically receive a one-year membership in the Standard Service Program (SSP) with the purchase of most software products and bundles including NI Developer Suite. NI also offers flexible extended contract options that guarantee your SSP benefits are available without interruption for as long as you need them. Visit ni.com/ssp for more information. For information about other technical support options in your area, visit ni.com/services, or contact your local office at ni.com/contact.
- **Training and Certification**—Visit ni.com/training for training and certification program information. You can also register for instructor-led, hands-on courses at locations around the world.
- **System Integration**—If you have time constraints, limited in-house technical resources, or other project challenges, National Instruments Alliance Partner members can help. To learn more, call your local NI office or visit ni.com/alliance.
- **Declaration of Conformity (DoC)**—A DoC is our claim of compliance with the Council of the European Communities using the manufacturer’s declaration of conformity. This system affords the user protection for electromagnetic compatibility (EMC) and product safety. You can obtain the DoC for your product by visiting ni.com/hardref.nsf.

You also can visit the Worldwide Offices section of ni.com/niglobal to access the branch office Web sites, which provide up-to-date contact information, support phone numbers, email addresses, and current events.

Glossary

Symbol	Prefix	Value
μ	micro	10^{-6}
m	milli	10^{-3}
M	mega	10^6

Numbers/Symbols

/	per
%	percent
\pm	plus or minus
+5 V	+5 VDC source signal

A

A	Amperes
absolute mode	Treat the target position loaded as position relative to zero (0) while making a move.
absolute position	Position relative to zero.
active-high	A signal is active when its value goes high (1).
active-low	A signal is active when its value goes low (0).
address	Character code that identifies a specific location (or series of locations) in memory or on a host PC bus system.
amplifier	The drive that delivers power to operate the motor in response to low level control signals. In general, the amplifier is designed to operate with a particular motor type—you cannot use a stepper drive to operate a DC brushed motor, for instance.
API	application programming interface
axis	Unit that controls a motor or any similar motion or control device.

B

b	bit—one binary digit, either 0 or 1.
base address	Memory address that serves as the starting address for programmable or I/O bus registers. All other addresses are located by adding to the base address.
binary	A number system with a base of 2.
buffer	Temporary storage for acquired or generated data (software).
bus	The group of conductors that interconnect individual circuitry in a computer. Typically, a bus is the expansion vehicle to which I/O or other devices are connected.
byte	Eight related bits of data, an eight-bit binary number. Also used to denote the amount of memory required to store one byte of data.

C

CCW	counter-clockwise—implies direction of rotation of the motor.
closed-loop	A motion system that uses a feedback device to provide position and velocity data for status reporting and accurately controlling position and velocity.
common	Reference signal for digital I/O.
crosstalk	An unwanted signal on one channel due to an input on a different channel.
CSR	communications status register
CW	clockwise—implies direction of motor rotation.

D

dedicated	Assigned to a particular function.
DGND	digital ground signal
digital I/O port	a group of digital input/output signals

DLL	dynamically-linked library—provides the API for the motion control boards.
drivers	Software that communicates commands to control a specific motion control board.
DSP	digital signal processor

E

encoder	Device that translates mechanical motion into electrical signals; used for monitoring position or velocity in a closed-loop system.
encoder resolution	The number of encoder lines between consecutive encoder indexes (marker or Z-bit). If the encoder does not have an index output the encoder resolution can be referred to as lines per revolution.

F

f	farad
FIFO	first-in, first-out
filtering	A type of signal conditioning that filters unwanted signals from the signal being measured.
flash ROM	A type of electrically reprogrammable read-only memory.
following error trip point	The difference between the instantaneous commanded trajectory position and the feedback position.
FPGA	field programmable gate array
freewheel	The condition of a motor when power is de-energized and the motor shaft is free to turn with only frictional forces to impede it.
full-step	Full-step mode of a stepper motor—for a two phase motor this is done by energizing both windings or phases simultaneously.

G

Gnd	ground
-----	--------

Glossary

GND ground

H

half-step Mode of a stepper motor—for a two phase motor this is done by alternately energizing two windings and then only one. In half step mode, alternate steps are strong and weak but there is significant improvement in low-speed smoothness over the full-step mode.

hex hexadecimal

home switch (input) A physical position determined by the mechanical system or designer as the reference location for system initialization. Frequently, the home position also is regarded as the zero position in an absolute position frame of reference.

host computer Computer into which the motion control board is plugged.

I

I/O input/output—the transfer of data to and from a computer system involving communications channels, operator interface devices, and/or motion control interfaces.

ID identification

index Marker between consecutive encoder revolutions.

inverting The polarity of a switch (limit switch, home switch, and so on) in *active* state. If these switches are active-low they are said to have inverting polarity.

IRQ interrupt request

K

k kilo—the standard metric prefix for 1,000, or 10^3 , used with units of measure such as volts, hertz, and meters.

K kilo—the prefix for 1,024, or 2^{10} , used with B in quantifying data or computer memory.

L

LIFO	last-in, first-out
limit switch/ end-of-travel position (input)	Sensors that alert the control electronics that physical end of travel is being approached and that the motion should stop.

M

m	meters
MCS	move complete status
microstep	The proportional control of energy in the coils of a Stepper Motor that allow the motor to move to or stop at locations other than the fixed magnetic/mechanical pole positions determined by the motor specifications. This capability facilitates the subdivision of full mechanical steps on a stepper motor into finer microstep locations that greatly smooth motor running operation and increase the resolution or number of discrete positions that a stepper motor can attain in each revolution.
modulo position	Treat the position as within the range of total quadrature counts per revolution for an axis.

N

noise	An undesirable electrical signal—noise comes from external sources such as the AC power line, motors, generators, transformers, fluorescent lights, soldering irons, CRT displays, computers, electrical storms, welders, radio transmitters, and internal sources such as semiconductors, resistors, and capacitors. Noise corrupts signals you are trying to send or receive.
noninverting	The polarity of a switch (limit switch, home switch, etc.) in <i>active</i> state. If these switches are active-high, they are said to have non-inverting polarity.

O

open-loop Refers to a motion control system where no external sensors (feedback devices) are used to provide position or velocity correction signals.

P

PCI peripheral component interconnect—a high-performance expansion bus architecture originally developed by Intel to replace ISA and EISA. It is achieving widespread acceptance as a standard for PCs and workstations; it offers a theoretical maximum transfer rate of 132 MB/s.

port (1) A communications connection on a computer or a remote controller. (2) A digital port, consisting of eight lines of digital input and/or output.

position breakpoint Position breakpoint for an encoder can be set in absolute or relative quadrature counts. When the encoder reaches a position breakpoint, the associated breakpoint output immediately transitions.

power cycling Turning the host computer off and then back on, which causes a reset of the motion control board.

PWM pulse width modulation—a method of controlling the average current in a motor phase winding by varying the on-time (duty cycle) of transistor switches.

PXI PCI eXtensions for Instrumentation

Q

quadrature counts The encoder line resolution times four.

R

RAM random-access memory

relative breakpoint Sets the position breakpoint for an encoder in relative quadrature counts.

relative position	Destination or target position for motion specified with respect to the current location regardless of its value.
relative position mode	Position relative to current position.
ribbon cable	A flat cable in which the conductors are side by side.
RPM	revolutions per minute—units for velocity.
RPS/PS or RPS/S	revolutions per second squared—units for acceleration and deceleration.
RTR	ready to receive
RTSI	real-time system integration bus—the National Instruments timing bus that connects devices directly, by means of connectors on top of the devices, for precise synchronization of functions.

S

s	seconds
servo	Specifies an axis that controls a servo motor.
stepper	Specifies an axis that controls a stepper motor.

T

toggle	Changing state from high to low, back to high, and so on.
torque	Force tending to produce rotation.
trapezoidal profile	A typical motion trajectory, where a motor accelerates up to the programmed velocity using the programmed acceleration, traverses at the programmed velocity, then decelerates at the programmed acceleration to the target position.
trigger	Any event that causes or starts some form of data capture.
TTL	transistor-transistor logic

V

V volts

V_{CC} Positive voltage supply.

velocity mode Move the axis continuously at the specified velocity.

W

watchdog A timer task that shuts down (resets) the motion control board if any serious error occurs.

word The standard number of bits that a processor or memory manipulates at one time, typically 8-, 16-, or 32-bit.

Index

Numerics

68-pin

- digital I/O connector, 3-3
- motion I/O connector, 3-3

7340

- analog feedback, 3-5
- axes, 3-5
- breakpoint outputs, 4-9
- configuring, 2-1
- embedded operating system, 3-4
- encoder signals, 4-7
- features, 1-1
- flash memory, 3-5
- general-purpose digital I/O lines, 4-13
- hardware, 1-1
 - architecture, 3-4
- home inputs, 4-5
- input and output signal connections, 4-1
- installing software, 2-1
- introduction, 1-1
- limit inputs, 4-5
- motion
 - I/O connections, 1-3
 - I/O connector, 4-1
 - resources, 3-6
- National Instruments application
 - software, 1-3
- overview, 3-1
- pulse width modulation (PWM)
 - outputs, 4-14
- shutdown input, 4-9
- software programming choices, 1-2
- trajectory generators, 3-4
- trigger inputs, 4-9
- user connectors, 3-3
- using RTSI, 1-2

A

- Analog Input <1..4>, 4-11
- Analog Input Ground, 4-12
- Analog Output <1..4>, 4-4
- Analog Output Ground, 4-4

Analog Reference, 4-12

analog signals, wiring, 4-12

axes, 3-5

secondary

- feedback resources, 3-6
- output resources, 3-6

Axis <1..4>

- Forward Limit Input, 4-5
- Home Input, 4-5
- Inhibit, 4-4
- Reverse Limit Input, 4-5
- Step (CW) and Dir (CCW), 4-4

B

breakpoint

- concepts, 3-7
- examples, 4-14

breakpoint output

- circuit, 4-11
- signals, wiring, 4-10

Breakpoint Output <1..4>, 4-9

buffers, 3-7

C

command buffer, 3-7

communications status register (CSR), 3-7

communications, host, 3-7

connectors

68-pin

- digital I/O, 3-3, 4-1
- motion I/O, 3-3, 4-1
- motion I/O, 4-1
- RTSI, 3-3, 4-1

D

Declaration of Conformity (NI resources), C-1

diagnostic tools (NI resources), C-1

documentation

- NI resources, C-1
- related documentation, 1-4

drivers (NI resources), C-1

E

- Encoder <1..4>
 - Index, 4-8
 - Phase A/Phase B, 4-7
- encoder signals, ground connections, 4-8
- examples (NI resources), C-1

F

- functional overview
 - buffers, 3-7
 - host communications, 3-7
 - onboard programs, 3-7

G

- ground connections
 - encoder signals, 4-8
 - wiring
 - breakpoint outputs, 4-10
 - shutdown input, 4-10
 - trigger inputs, 4-10

H

- help, technical support, C-1
- high-speed capture, 3-7
- home inputs
 - circuit, 4-5, 4-6
 - ground connections, 4-6
- Host +5 V, 4-12
- host communications, 3-7

I

- installing
 - hardware, 2-3
 - software, 2-1
- instrument drivers (NI resources), C-1

K

- KnowledgeBase, C-1

L

- limit input circuit, 4-5, 4-6
- limit inputs, ground connections, 4-6

M

- memory, buffer storage, 3-7
- motion I/O, connector
 - pin assignments, 4-2
 - signal descriptions, 4-3

N

- National Instruments support and services, C-1

O

- onboard programs, 3-7

P

- pin assignments, 68-pin digital I/O connector, 4-13
- programming examples (NI resources), C-1

R

- related documentation, 1-4
- return data buffer (RDB), 3-7
- RTSI
 - breakpoint across RTSI (figure), 4-14
 - connector, 3-3, 4-14
 - signal considerations, 4-14

S

- safety information, 2-1
- Shutdown Input, 4-9
- software (NI resources), C-1
- software, onboard programs, 3-7
- support, technical, C-1

T

- training and certification (NI resources), C-1
- Trigger Input <1..4>, 4-9
- trigger input circuit, 4-10
- trigger inputs, wiring, 4-10
- troubleshooting (NI resources), C-1

W

- Web resources, C-1
- wiring, analog signals, 4-12