

COMPREHENSIVE SERVICES

We offer competitive repair and calibration services, as well as easily accessible documentation and free downloadable resources.

SELL YOUR SURPLUS

We buy new, used, decommissioned, and surplus parts from every NI series. We work out the best solution to suit your individual needs.

 Sell For Cash  Get Credit  Receive a Trade-In Deal

OBSOLETE NI HARDWARE IN STOCK & READY TO SHIP

We stock **New**, **New Surplus**, **Refurbished**, and **Reconditioned** NI Hardware.



Bridging the gap between the manufacturer and your legacy test system.

 1-800-915-6216

 www.apexwaves.com

 sales@apexwaves.com

All trademarks, brands, and brand names are the property of their respective owners.

Request a Quote

 **CLICK HERE**

PXI-7952R

NI 5782R User Manual and Specifications

The NI 5782 is an analog dual-input, dual-output, intermediate-frequency (IF) transceiver adapter module designed to work with your NI FlexRIO™ FPGA module. The NI 5782 features two analog input (AI) channels with 14-bit sample rates of up to 250 MS/s. The NI 5782 also has two analog output (AO) channels with 16-bit sample rates of up to 500 MS/s when using both AO channels, or up to 1 GS/s when using only one AO channel.

This document contains signal information and specifications for the NI 5782R, which is composed of an NI FlexRIO FPGA module and the NI 5782 adapter module. This document also contains tutorial sections that demonstrate how to acquire data using a LabVIEW FPGA example VI and how to create and run your own LabVIEW project with the NI 5782R.



Note *NI 5782R* refers to the combination of your NI 5782 adapter module and your NI FlexRIO FPGA module. *NI 5782* refers to your NI 5782 adapter module only.



Caution The protection provided by the NI 5782R can be impaired if it is used in a manner not described in this document.

Contents

Electromagnetic Compatibility Guidelines	2
How to Use Your NI FlexRIO Documentation Set	3
Front Panel and Connector Pinouts	4
Block Diagram	7
NI 5782 Component-Level Intellectual Property (CLIP)	8
Connecting Cables	10
Clocking	10
Using Your NI 5782R with a LabVIEW FPGA Example VI	11
Creating a LabVIEW Project and Running a VI on an FPGA Target	13
Appendix A: Specifications	16
Appendix B: Installing EMI Controls	34
Where to Go for Support	36

Figure 1. NI FlexRIO Device

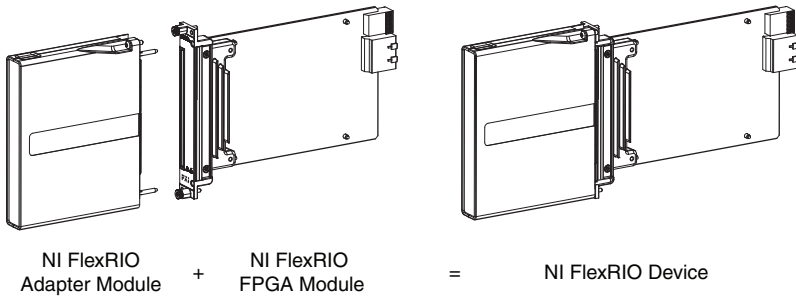

Note Before configuring your NI 5782R, you must install the appropriate software and hardware. Refer to the *NI FlexRIO FPGA Module Installation Guide and Specifications* for installation instructions. Figure 1 shows an example of a properly connected NI FlexRIO device.

Electromagnetic Compatibility Guidelines

This product was tested and complies with the regulatory requirements and limits for electromagnetic compatibility (EMC) as stated in the product specifications. These requirements and limits are designed to provide reasonable protection against harmful interference when the product is operated in its intended operational electromagnetic environment.

This product is intended for use in industrial locations. There is no guarantee that harmful interference will not occur in a particular installation, when the product is connected to a test object, or if the product is used in residential areas. To minimize the potential for the product to cause interference to radio and television reception or to experience unacceptable performance degradation, install and use this product in strict accordance with instructions in the product documentation.

Furthermore, any changes or modifications to the product not expressly approved by National Instruments could void your authority to operate it under your local regulatory rules.



Caution To ensure the specified EMC performance, you must install PXI EMC Filler Panels (National Instruments part number 778700-01) in adjacent chassis slots. For more information about installing PXI EMC filler panels in your system, refer to the [Appendix B: Installing EMI Controls](#) section of this document.



Caution To ensure the specified EMC performance, operate this product only with shielded cables and accessories.



Caution This product is sensitive to electrostatic discharge (ESD). To ensure the specified EMC performance, follow the programming instructions listed at the end of the [Using Your NI 5782R with a LabVIEW FPGA Example VI](#) and [Creating a LabVIEW Project and Running a VI on an FPGA Target](#) sections of this document.



Caution To ensure the specified EMC performance, the length of all I/O cables must be no longer than 30 m (100 ft).

How to Use Your NI FlexRIO Documentation Set

Refer to Figure 2 and Table 1 for information about how to use your NI FlexRIO documentation set.

Figure 2. How to Use Your NI FlexRIO Documentation Set

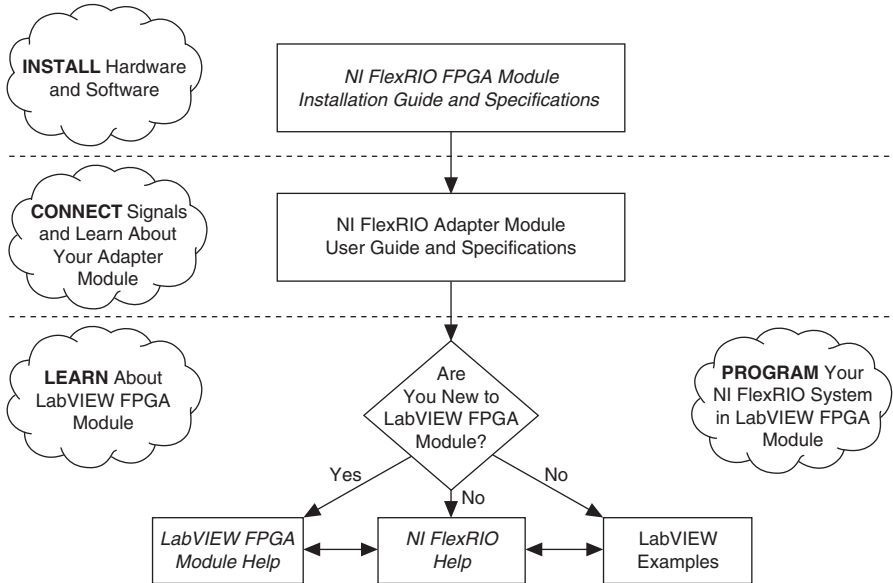

Table 1. NI FlexRIO Documentation Locations and Descriptions

Document	Location	Description
NI FlexRIO FPGA Module Installation Guide and Specifications	Available in your FPGA module hardware kit, from the Start Menu, and at ni.com/manuals .	Contains installation instructions for your NI FlexRIO system and specifications for your FPGA module.
<i>NI 5782R User Manual and Specifications</i> (this document)	Available from the Start Menu and at ni.com/manuals .	Contains signal information, examples, CLIP details, and specifications for your adapter module.
LabVIEW FPGA Module Help	Embedded in <i>LabVIEW Help</i> and at ni.com/manuals .	Contains information about the basic functionality of the LabVIEW FPGA module.
NI FlexRIO Help	Available from the Start menu and at ni.com/manuals .	Contains FPGA module, adapter module, and CLIP configuration information.
LabVIEW Examples	Available in NI Example Finder.	Contains examples of how to run FPGA VIs and Host VIs on your device.
IPNet	ni.com/ipnet	Contains LabVIEW FPGA functions and intellectual property to share.
NI FlexRIO product page	ni.com/flexrio	Contains product information and data sheets for NI FlexRIO devices.

Front Panel and Connector Pinouts

Table 2 shows the front panel connector and signal descriptions for the NI 5782. Refer to [Appendix A: Specifications](#) for additional signal information.



Caution To avoid permanent damage to the NI 5782, disconnect all signals connected to the NI 5782 before powering down the module, and connect signals only after the adapter module has been powered on by the NI FlexRIO FPGA module.



Caution Connections that exceed any of the maximum ratings of any connector on the NI 5782R can damage the device and the chassis. NI is not liable for any damage resulting from such signal connections. For the maximum input and output ratings for each signal, refer to [Appendix A: Specifications](#).

Table 2. NI 5782 Front Panel Connectors

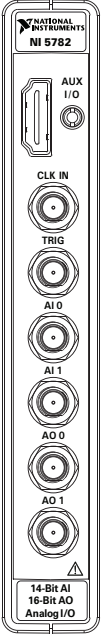
Device Front Panel	Connector	Signal Description
	AUX I/O	Refer to Table 3 for the signal list and descriptions.
	CLK IN	50 Ω single-ended (SE) external Reference or Sample Clock input.
	TRIG	Trigger input channel.
	AI 0	50 Ω SE analog input (AI) channel 0.
	AI 1	50 Ω SE AI channel 1.
	AO 0	50 Ω SE analog output (AO) channel 0.
	AO 1	50 Ω SE AO channel 1.

AUX I/O Connector

Table 3. NI 5782 AUX I/O Connector Pin Assignments

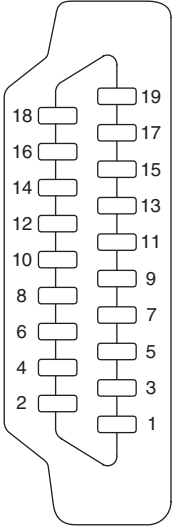
AUX I/O Connector	Pin	Signal	Signal Description
	1	DIO Port 0 (Bit 0)	Bidirectional single-ended (SE) digital I/O (DIO) data channel.
	2	GND	Ground reference for signals.
	3	DIO Port 0 (Bit 1)	Bidirectional SE DIO data channel.
	4	DIO Port 0 (Bit 2)	Bidirectional SE DIO data channel.
	5	GND	Ground reference for signals.
	6	DIO Port 0 (Bit 3)	Bidirectional SE DIO data channel.
	7	DIO Port 1 (Bit 0)	Bidirectional SE DIO data channel.
	8	GND	Ground reference for signals.
	9	DIO Port 1 (Bit 1)	Bidirectional SE DIO data channel.
	10	DIO Port 1 (Bit 2)	Bidirectional SE DIO data channel.
	11	GND	Ground reference for signals.
	12	DIO Port 1 (Bit 3)	Bidirectional SE DIO data channel.
	13	PFI 0	Bidirectional SE DIO data channel.
	14	NC	No connect.
	15	PFI 1	Bidirectional SE DIO data channel.
	16	PFI 2	Bidirectional SE DIO data channel.
	17	GND	Ground reference for signals.
	18	+5V	+5 V power (10 mA maximum).
	19	PFI 3	Bidirectional SE DIO data channel.



Caution The AUX I/O connector accepts a standard, third-party HDMI cable, but the AUX I/O port is not an HDMI interface. Do not connect the AUX I/O port on the NI 5782 into the HDMI port of another device. NI is not liable for any damage resulting from such signal connections.

Block Diagram

Figure 3 shows the NI 5782 block diagram and signal flow to and from the NI 5782 component-level intellectual property (CLIP) by way of the adapter module and the corresponding NI 5782 Multiple Sample CLIP in LabVIEW FPGA.

Figure 3. NI 5782 Connector Signals and NI 5782 CLIP Signal Block Diagram

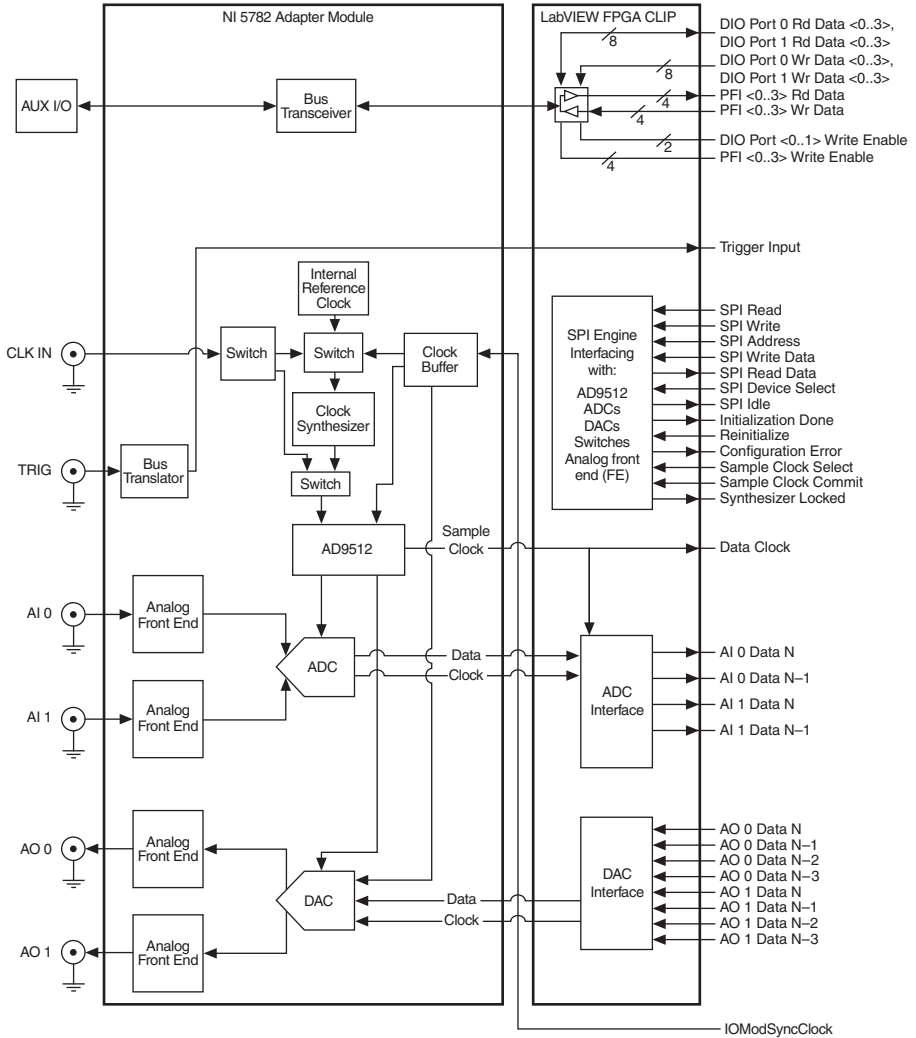

NI 5782 Component-Level Intellectual Property (CLIP)

The LabVIEW FPGA Module includes component-level intellectual property (CLIP) for HDL IP integration. NI FlexRIO devices support two types of CLIP: user-defined and socketed.

- *User-defined CLIP* allows you to insert HDL IP into an FPGA target, enabling VHDL code to communicate directly with an FPGA VI.
- *Socketed CLIP* provides the same IP integration functionality of the user-defined CLIP, but also allows the CLIP to communicate directly with circuitry external to the FPGA. Adapter module socketed CLIP allows your IP to communicate directly with both the FPGA VI and the external adapter module connector interface.

The following figure shows the relationship between an FPGA VI and CLIP.

Figure 4. CLIP and FPGA VI Relationship

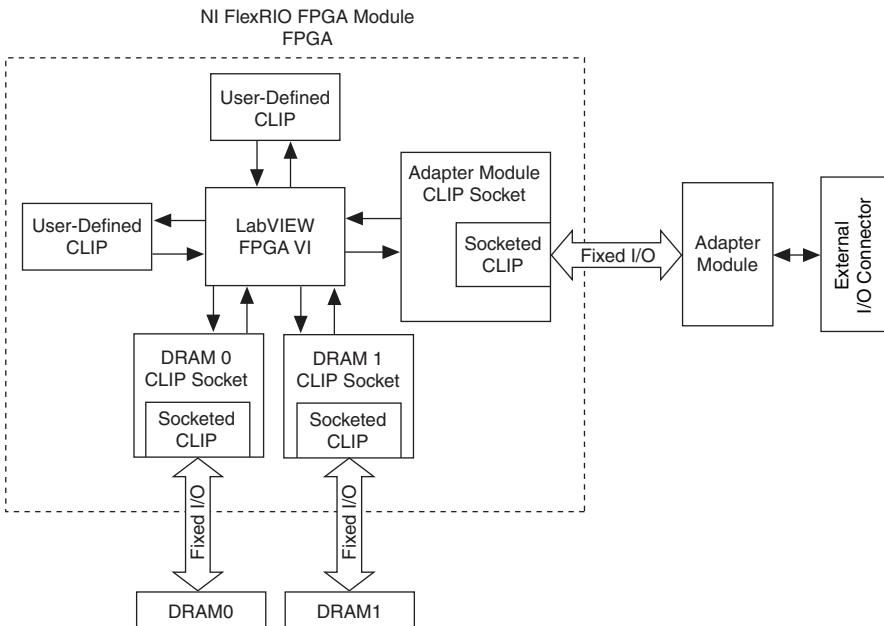

The NI 5782 ships with socketed CLIP items that add module I/O to the LabVIEW project. The NI 5782 ships with the following CLIP items:

1. **NI 5782 Multiple Sample CLIP**—The analog input channels generate two samples per clock cycle at a clock rate that is half the sample rate. The analog output channels generate four samples per clock cycle at a clock rate that is one quarter of the sample rate. The AI default sample rate is 250 MHz, and the AO default sample rate is 500 MHz. The default clock rate for this CLIP is 125 MHz. You can set a lower sample rate by using an external Sample Clock.

This CLIP presents the data to the diagram in a decelerated format. The ADC data lands at half the rate as the ADC clock. The DAC data must be presented in four time samples per clock on each channel.

This CLIP provides access to two AI channels, two AO channels, eight bidirectional DIO channels, four bidirectional PFI channels, and an input clock selector that can be configured to use one of the following settings:

- Internal Sample Clock
- Internal Sample Clock locked to an external Reference Clock through the CLK IN connector
- External Sample Clock through the CLK IN connector
- Internal Sample Clock locked to an external Reference Clock through IoModSyncClock
- External Sample Clock through IoModSyncClock

This CLIP also contains an engine to program the CLK chip, ADCs, and DACs, either through predetermined settings for an easier instrument setup, or through a raw SPI address and data signals for a more advanced setup. The NI 5782 Multiple Sample CLIP is the default CLIP.

2. **NI 5782 Single Sample CLIP**—The analog input channels generate one sample per clock cycle and the analog output channels generate two samples per clock cycle. The default clock rate for the Multiple Sample CLIP is 250 MHz. The Sample Clock rates of AI (250 MHz) and AO (500 MHz) are the same as Multiple Sample CLIP. You can set lower sample rates with the external Sample Clock.

This CLIP presents the data to the diagram at a clock rate such that the ADC data lands at the same rate as the ADC clock. However, the DAC data must be presented in two time samples per clock on each channel.

This CLIP provides access to two AI channels, two AO channels, eight bidirectional DIO channels, four bidirectional PFI channels, and an input clock selector that can be configured to use one of the following settings:

- Internal Sample Clock
- Internal Sample Clock locked to an external Reference Clock through the CLK IN connector
- External Sample Clock through the CLK IN connector

- Internal Sample Clock locked to an external Reference Clock through IoModSyncClock
- External Sample Clock through IoModSyncClock

This CLIP also contains an engine to program the CLK chip, ADCs, and DACs, either through predetermined settings for an easier instrument setup, or through a raw SPI address and data signals for a more advanced setup.

Refer to the *NI FlexRIO Help* for more information about NI FlexRIO CLIP items, how to configure the NI 5782 with a socketed CLIP, and for a list of available socketed CLIP signals.

Connecting Cables

- Use any 50 Ω SMA cable to connect signals to the connectors on the front panel of your NI 5782.
- Use the SHH19-H19-AUX cable (NI part number: 152629-01 or 152629-02) to connect to the DIO and PFI signals on the AUX I/O connector.

For more information about connecting I/O signals on your device, refer to the [Appendix A: Specifications](#) section of this document.

Clocking

The NI 5782 clocks control the sample rate and other timing functions on the device. Table 4 contains information about the possible NI 5782 clock resources.

Table 4. NI 5782 Clock Sources

Clock	Frequency	Source Options
Internal Clock PLL Off	500 MHz	The internal voltage-controlled oscillator (VCO) acts as a free-running clock.
Internal Clock PLL On (IoModSyncClock)	500 MHz	The internal VCO locks to PXI_CLK10 through IoModSyncClock, which is available only through the backplane of NI PXIe-796xR devices.
Internal Clock PLL On (CLK IN)	500 MHz	The internal VCO locks to an external Reference Clock (10 MHz). Connect the external Reference Clock through the CLK IN front panel connector.
External Clock (CLK IN)	250 MHz to 1 GHz	Connect an external Sample Clock through the CLK IN front panel connector.

Using Your NI 5782R with a LabVIEW FPGA Example VI



Note You must install the software before running this example. Refer to the *NI FlexRIO FPGA Module Installation Guide and Specifications* for more information about installing your software.

The NI FlexRIO Adapter Module Support software includes example projects to help you get started creating your LabVIEW FPGA application. This section explains how to use an existing LabVIEW FPGA example project to generate and acquire samples with the NI 5782R. This example requires at least one SMA cable to connect signals to your NI 5782R.



Note The examples available for your device depend on the version of the software and driver you are using. For more information about which software versions are compatible with your device, visit ni.com/info and enter `rdsoftwareversion` in the text field.

Each NI 5782R example project includes the following components:

- A LabVIEW FPGA VI that can be compiled and run on the FPGA embedded in the hardware
- A VI that runs on Windows and interacts with the LabVIEW FPGA VI



Note In the LabVIEW FPGA Module software, NI FlexRIO adapter modules are referred to as *IO Modules*.

Complete the following steps to run an example that acquires a waveform on CH 0 of the NI 5782.

1. Connect one end of an SMA cable to AI 0 on the front panel of the NI 5782 and the other end of the cable to your device under test (DUT).
2. Launch LabVIEW.
3. Click **Help»Find Examples** to display the NI Example Finder.
4. In the **NI Example Finder** window, select **Hardware Input and Output»FlexRIO»IO Modules»NI 5782**.
5. Select **NI 5782 - Getting Started.lvproj**.
6. In the **Project Explorer** window, open **NI 5782 - Getting Started (Host).vi** under **My Computer** to open the host VI. The Open FPGA VI Reference function in this VI uses the NI 7952R as the FPGA target by default. If you are using an NI FlexRIO FPGA module other than the NI 7952R, complete the following steps to change to the FPGA VI to support your target.
 - a. Select **Window»Show Block Diagram** to open the VI block diagram.
 - b. On the block diagram, right-click the Open FPGA VI Reference (PXI-7952R) function and select **Configure Open FPGA VI Reference**.

- c. In the **Configure Open FPGA VI Reference** dialog box, click the **Browse** button next to the **Bitfile** button.
 - d. In the **Select Bitfile** dialog box that opens, select the bitfile for your desired target. The bitfile name is based on the adapter module, example type, and FPGA module.
 - e. Click the **Select** button.
 - f. Click **OK** in the **Configure Open FPGA VI Reference** dialog box.
 - g. Save the VI.
7. On the front panel, in the **RIO Resource** pull-down menu, select an NI 5782R resource that corresponds with the target that you configured in step 6.
 8. Select **AI 0** in the **AI Channel control**.
 9. Set the **Trigger Level (V)** and the **Record Size** controls to the desired values.
 10. In the **Trigger Type** box, select either **Software** or **Data Edge**. If you select **Software**, the VI acquires data every time you click the **Software Trigger** button on the front panel of the VI. If you select **Data Edge**, the VI acquires data every time an edge occurs.
 11. Click the **Run** button to run the VI.
 12. Click the **Software Trigger** button if you selected **Software** in the **Trigger Type** control. The VI acquires data and displays the captured waveform on the **Acquired Waveform** graph as shown in Figure 5.
 13. Click the **STOP** button to stop the VI.
 14. Close the VI.

Figure 5. NI 5782 - Getting Started (Host) VI Front Panel

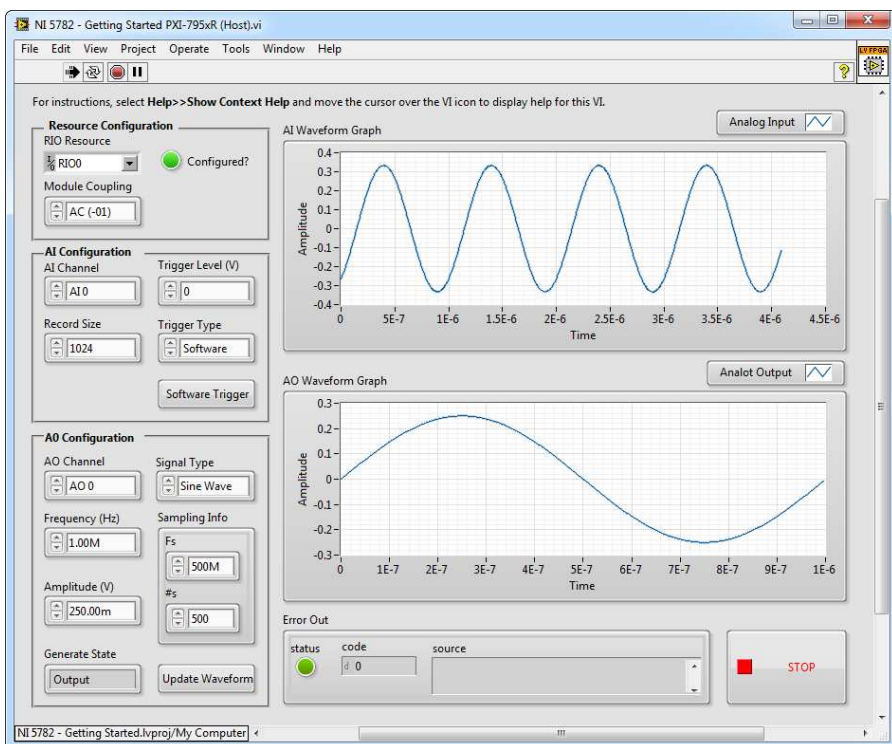

Creating a LabVIEW Project and Running a VI on an FPGA Target

This section explains how to set up your target and create an FPGA VI and a host VI for data communication. This section focuses on proper project configuration, proper CLIP configuration, and how to access 5782 AI IO nodes. For more detailed information about acquiring data on your NI 5782R, refer to the device-specific examples available in NI Example Finder.

Creating a Project

1. Launch LabVIEW. If LabVIEW is already running, select **File»Create Project**.
2. In the **Create Project** dialog box, select **LabVIEW FPGA Project** and click **Finish**.
3. In the **Create New LabVIEW FPGA Project** dialog box, select **FlexRIO on My Computer** and click **Next**.
4. If your FlexRIO device is connected to your system, select **Discover Existing System**. If your device is not connected to your system, select **Create New System** and click **Next**.
5. Select your device and click **Next**.

- LabVIEW generates a preview of your project. Verify that the project is correct and select **Finish**. The new project opens in the **Project Explorer** window.

Creating an FPGA Target VI

- Right-click **FPGA Target (RIOx, PXI-79xxR)** and select **New»FPGA Base Clock**.
- In the **Resource** pull-down menu, select **200 MHz Clock** and click **OK**.
- Right-click **IO Module (5782)** in the **Project Explorer** window and select **Properties**.
- In the **Clock Selections** category, select **200 MHz Clock** from the pull-down menu for **Clk200**. Leave **Clk40** configured as the **Top-Level Clock**.
- Select **NI 5782 CLIP** in the **Name** list of the **Component Level IP** pane.
- In the **Clock Selections** category, select **200 MHz Clock** from the pull-down menu for **Clk200**. Leave **Clk40** configured as the **Top-Level Clock**.
- Click **OK**.



Note Configuring these clocks is required for proper CLIP operation. Refer to the NI 5782 CLIP topics in the *NI FlexRIO Help* for more information about configuring your clocks.

- In the **Project Explorer** window, right-click the FPGA target and select **New»VI** to open a blank VI.
- Select **Window»Show Block Diagram** to open the VI block diagram.
- In the **Project Explorer** window, expand the **IO Module (NI 5782 : NI 5782)** tree view.
- Drag **AI 0 Data N-1** to the block diagram.
- Click and drag the bottom edge of the control node to expose the other signals, **AI 0 N-1...AI 1 N**.
- Add a Timed Loop structure around the node.
- Wire indicators to each output terminal of the **IO Module\AI 0 N-1...AI 1 N**.
- Right-click the input node of the Timed Loop to wire an FPGA Clock Constant to the node. Set this constant to **IO Module\Data Clock**.

Your block diagram should resemble the block diagram in Figure 6.

Figure 6. 5782SampleAcq (FPGA).vi Block Diagram

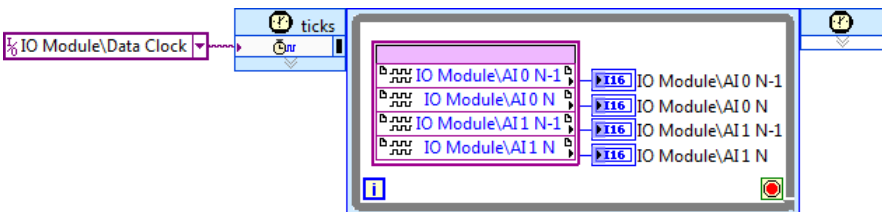



Tip Click the **Clean Up Diagram** button on the toolbar to cleanly organize the VI block diagrams.

16. Save the VI as `5782SampleAcq (FPGA).vi`.
17. Click the **Run** button. LabVIEW creates a default build specification and begins compiling the VI. The **Generating Intermediate Files** window opens and displays the code generation progress. Next, the **Compilation Status** window opens and displays the progress of the compilation. The compilation takes several minutes.
18. Click **Close** in the **Compilation Status** window.
19. Save and close the VI.
20. Save the project.

Creating a Host VI

1. In the **Project Explorer** window, right-click **My Computer** and select **New»VI** to open a blank VI.
2. Select **Window»Show Block Diagram** to open the VI block diagram.
3. Add the Open FPGA VI Reference function, located on the **FPGA Interface** palette, to the block diagram.
4. Drag and drop your **5782SampleAcq(FPGA).vi** into the Open FPGA VI Reference. The target name appears under the Open FPGA VI Reference function in the block diagram.
5. In the block diagram, add a While Loop to the right of the Open FPGA VI Reference function.
6. Right-click the conditional terminal inside the While Loop and select **Create Control** to create a STOP button on the VI front panel window.
7. Add the Read/Write Control function, located on the **FPGA Interface** palette, inside the While Loop.
8. Wire the **FPGA VI Reference Out** output terminal of the Open FPGA VI Reference function to the **FPGA VI Reference In** input terminal of the Read/Write Control function.
9. Wire the **error out** terminal of the Open FPGA VI Reference function to the **error in** control of the Read/Write Control function.
10. Configure the Read/Write Control function by clicking the terminal section labeled **Unselected**, and selecting **IO Module/AI 0 N-1**.
11. Click and drag the bottom edge of the control edge to expose the other signals, **AI 0 N-1...AI 1 N**, to the Read/Write Control function.
12. Wire indicators to each output terminal of the **IO Module\AI 0 N-1...AI 1 N**.
13. Add the Close FPGA VI Reference function, located on the **FPGA Interface** palette, to the right of the While Loop on the block diagram.
14. Wire the **FPGA VI Reference Out** terminal of the Read/Write Control function to the **FPGA VI Reference In** terminal of the Close FPGA VI Reference function.
15. Wire the **error out** terminal of the Read/Write Control function to the **error in** terminal of the Close FPGA VI Reference function.

Your block diagram should resemble the block diagram in Figure 7.

Figure 7. 5782SampleAcq(Host).vi Block Diagram

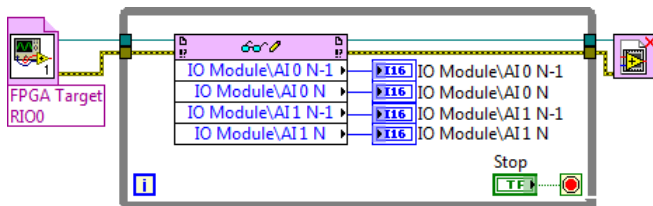

16. Save the VI as 5782SampleAcq(Host).vi.

Running the Host VI

1. Connect one end of an SMA cable to AI 0 on the front panel of the NI 5782 and the other end of the cable to your DUT.
2. Open the front panel of 5782SampleAcq(Host).vi.
3. Click the **Run** button to run the VI.
4. The VI acquires data from the DUT on **AI 0**, **AI 0 N-1**, **AI 1 N**, and **AI 1 N-1**.
5. Click the **STOP** button on the front panel and close the VI.

Appendix A: Specifications

This section lists the specifications of the NI FlexRIO adapter module (NI 5782). Pair these specifications with the specifications listed in the *NI FlexRIO FPGA Module Installation Guide and Specifications*. For more information about safety and electromagnetic compatibility refer to the *Read Me First: Safety and Electromagnetic Compatibility* document included in your hardware kit or available at ni.com/manuals.



Caution To avoid permanent damage to the NI 5782, disconnect all signals connected to the NI 5782 before powering down the module, and only connect signals after the module has been powered on by the NI FlexRIO FPGA module.



Note All numeric specifications are typical unless otherwise noted. All graphs illustrate the performance of a representative module.

Specifications are subject to change without notice. For the most recent device specifications, visit ni.com/manuals.

Analog Input (AI 0 and AI 1)

General Characteristics

Number of channels.....	Two, single-ended, simultaneously sampled
Connector.....	SMA
Input impedance	50 Ω , per connector
Sample rate	
Internal Sample Clock	250 MHz
External Sample Clock	175 MHz to 250 MHz
ADC part number	ADS62P49 ¹ ; 14-bit resolution, dual ADC

AC-Coupled Specifications

Input range (normal operating conditions)	+10.2 dBm (2.05 V _{pk-pk})
Absolute maximum input	50 Ω , ± 10 V DC, +18 dBm (5 V _{pk-pk}) AC
Bandwidth (-1 dB)	1 MHz to 250 MHz
Bandwidth (-3 dB)	0.1 MHz to 500 MHz

Table 5 lists the AC-coupled spectral performance measurements. All values are measured with a 500 MHz internal Sample Clock.

Table 5. Analog Input AC-Coupled Spectral Performance

Measurement	20.1 MHz	70.1 MHz	124.1 MHz
Signal-to-noise ratio (SNR)	70.5 dB	70.0 dB	68.8 dB
Signal-to-noise and distortion ratio (SINAD)	70.5 dB	69.8 dB	68.6 dB
Spurious-free dynamic range (SFDR)	90.0 dB	83.0 dB	80.0 dB

Channel-to-channel isolation

1 MHz	>90 dB
100.1 MHz	90 dB
501 MHz	70 dB

¹ For additional information on the ADS62P49, refer to the Texas Instruments device data sheet at www.ti.com.

Figure 8. Bandwidth (Passband)

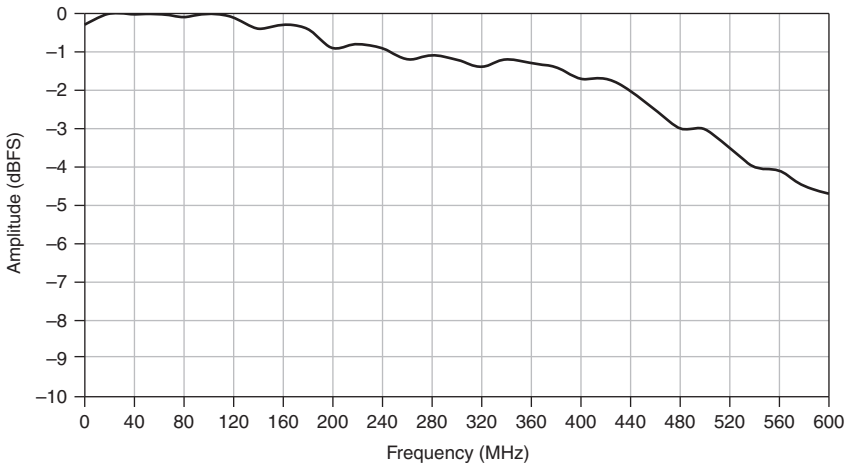

Figure 9. Terminated Input

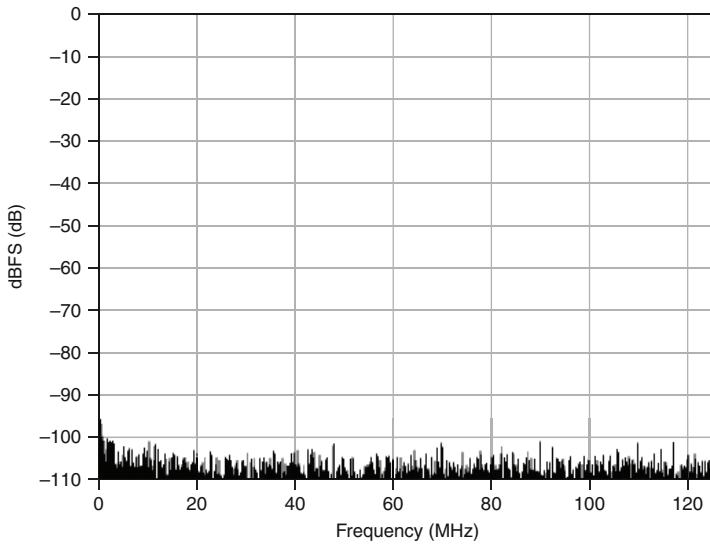

Figure 10. Analog Input One-Tone Spectral Measurement (70 MHz, -1 dBFS)

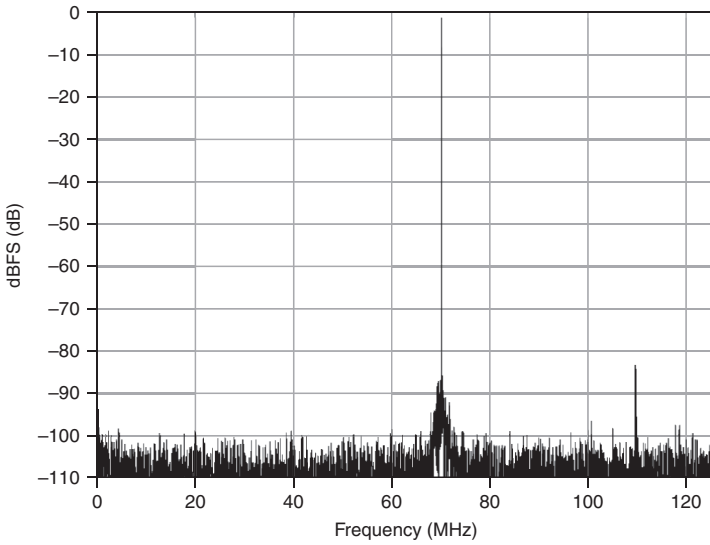
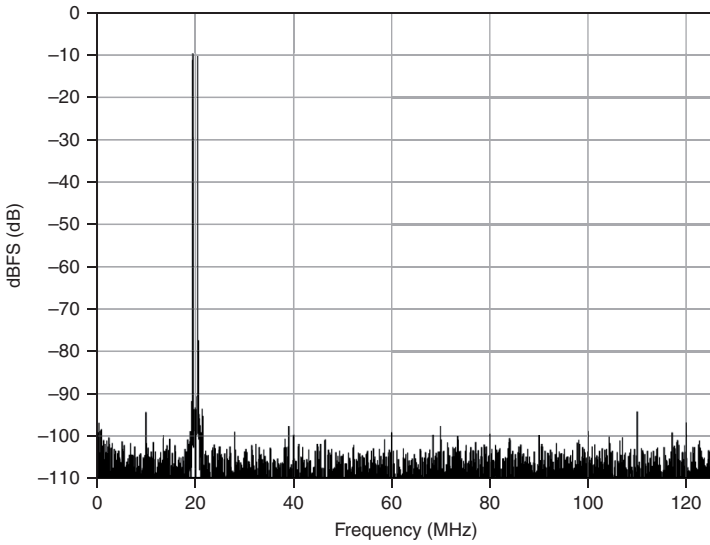

Figure 11. Two-Tone Spectral Measurement (19.5 and 20.5 MHz, -10 dBFS)



DC-Coupled Specifications

Input range (normal operating conditions)+4.0 dBm, 1.0 V_{pk-pk}

Absolute maximum input..... 50 Ω, ±4.5 V DC, +15 dBm (3.6 V_{pk-pk}) AC

Bandwidth (-1 dB)DC to 170 MHz

Bandwidth (-3 dB)DC to 330 MHz

Table 6 lists the DC-coupled spectral performance measurements. All values are measured with a 1 GHz internal Sample Clock.

Table 6. Analog Input DC-Coupled Spectral Performance

Measurement	20.1 MHz	70.1 MHz	124.1 MHz
SNR	67.3 dB	66.2 dB	65.5 dB
SINAD	67.0 dB	65.4 dB	64.0 dB
SFDR	80.0 dB	78.0 dB	66.0 dB

Channel-to-channel isolation

1 MHz 85 dB

100.1 MHz 85 dB

501 MHz 60 dB

Figure 12. Analog Input Bandwidth (Passband)

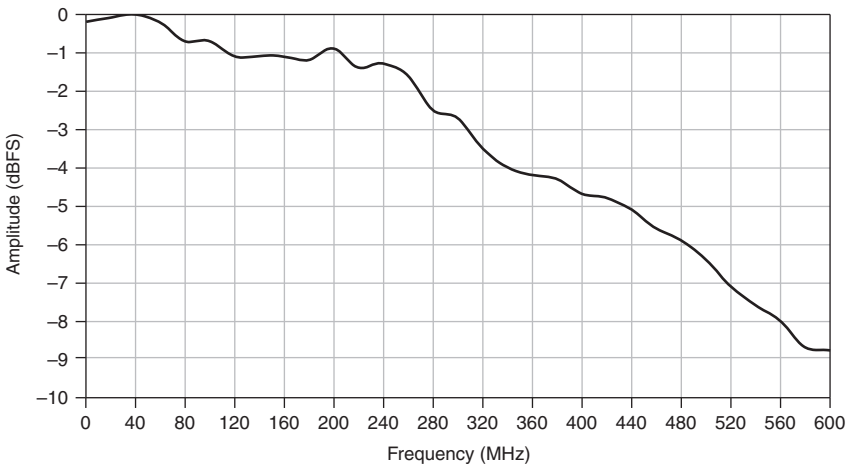

Figure 13. Analog Input Terminated Input

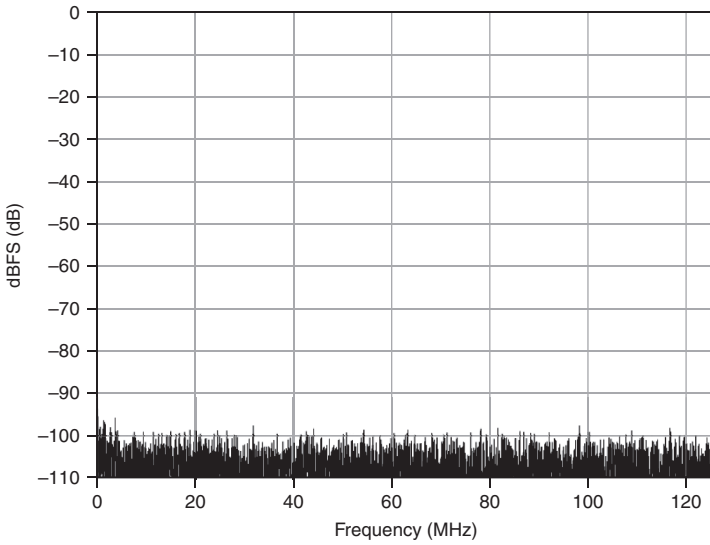

Figure 14. Analog Input One-Tone Spectral Measurement (70 MHz, -1 dBFS)

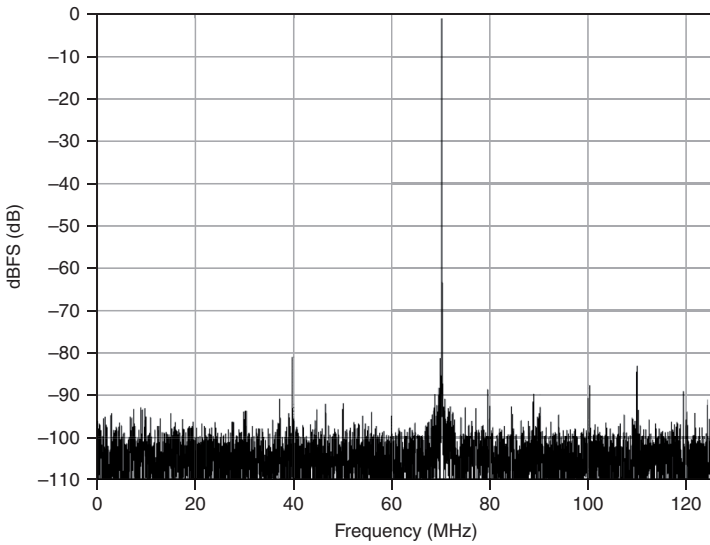
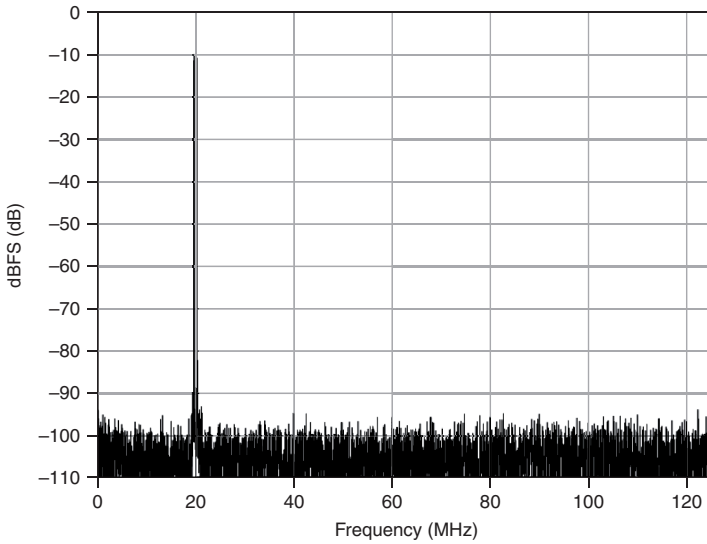

Figure 15. Two-Tone Spectral Measurement (19.5 and 20.5 MHz, -10 dBFS)



Analog Output (AO 0 and AO 1)

General Characteristics

Number of channels	Two, single-ended, simultaneously sampled
Connector	SMA
Output impedance	50 Ω , per connector
Sample rate	
DLL Off	<250 MHz
DLL On	250 MHz to 1 GHz
DAC part number	DAC5682Z ¹ ; 16-bit resolution, dual DAC

¹ For additional information on the DAC5682Z, refer to the Texas Instruments device data sheet at www.ti.com.

AC-Coupled Specifications

Output range (normal operating conditions) -0.5 dBm ($0.6 V_{pk-pk}$)

Bandwidth (-3 dB) 1 MHz to 225 MHz¹

SNR 70 dBc

Table 7. SFDR (70 MHz Out, 1 GS/s, no PLL)

Non-Harmonic	Second Harmonic	Third Harmonic
77 dBc	61 dBc	72 dBc

Channel-to-channel isolation

1 MHz 100 dB

100.1 MHz 90 dB

251 MHz 90 dB

Figure 16. Bandwidth (Passband)

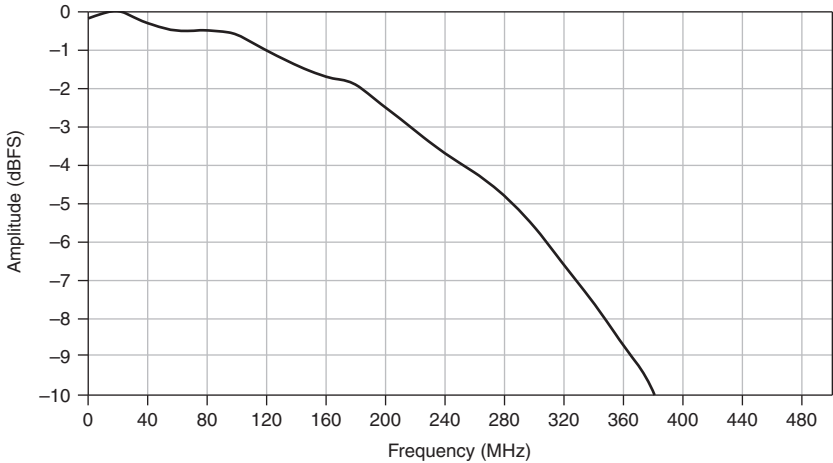

¹ Includes DAC sinc response.

Figure 17. Analog Output One-Tone Spectral Measurement (70 MHz, 0.25 dBm, 100 Hz Resolution Bandwidth, 100 kHz Bandwidth)

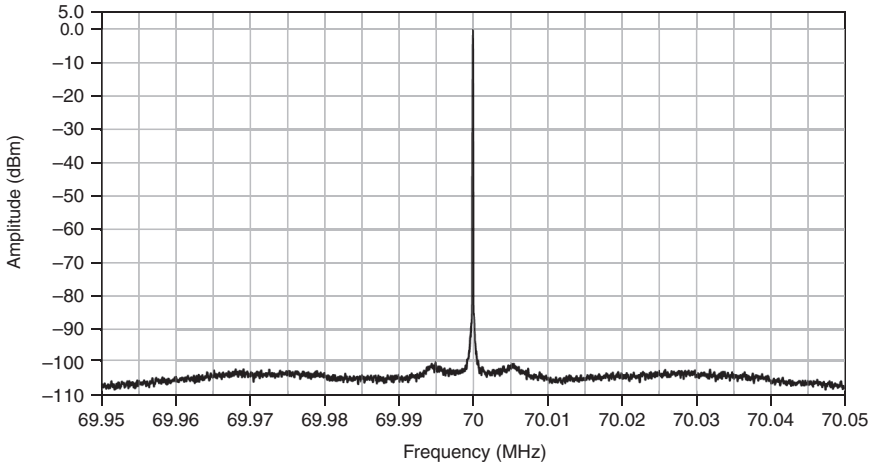

Figure 18. Analog Output One-Tone Spectral Measurement (70 MHz, 0.25 dBm, 1 kHz Resolution Bandwidth, 1 MHz Bandwidth)

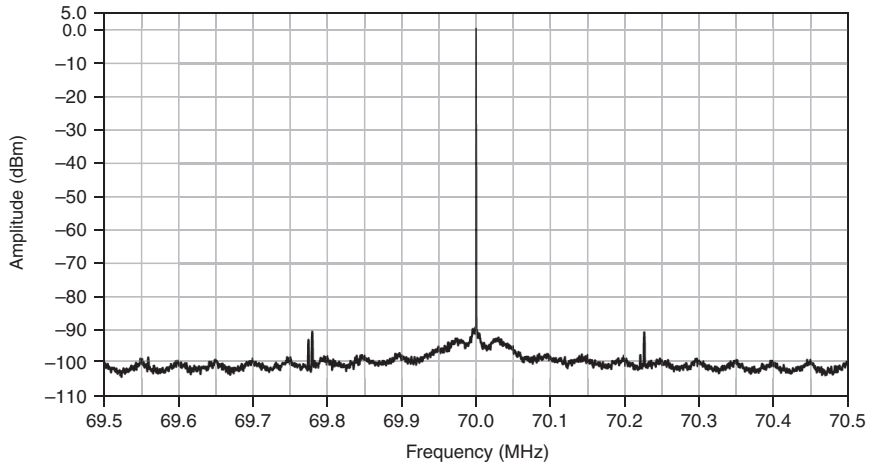

Figure 19. Analog Output One-Tone Spectral Measurement (70 MHz, 0.25 dBm, 1 kHz Resolution Bandwidth, 100 MHz Bandwidth)

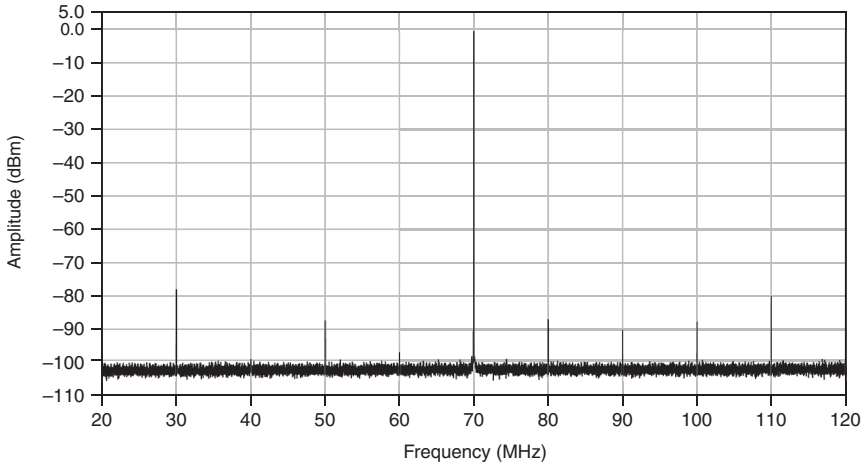
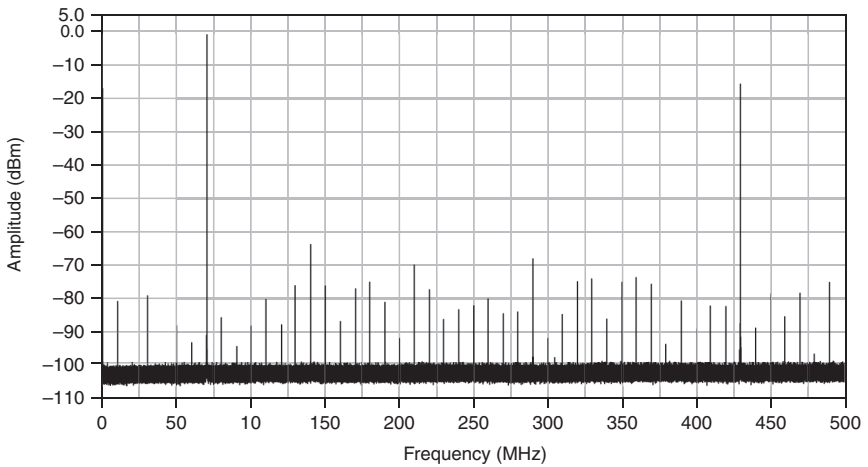

Figure 20. Analog Output One-Tone Spectral Measurement (70 MHz, 0.25 dBm, 1 kHz Resolution Bandwidth, 500 MHz Bandwidth)



DC-Coupled Specifications

Output range (normal operating conditions).....+4 dBm (1.0 V_{pk-pk})

Bandwidth (-3 dB)DC to 180 MHz¹

SNR.....66 dBc

Table 8. SFDR (70 MHz Out, 1 GS/s, no PLL)

Non-Harmonic	Second Harmonic	Third Harmonic
77 dBc	47 dBc	47 dBc

Channel-to-channel isolation

1.0 MHz 100 dB

100.1 MHz 100 dB

251.0 MHz 87 dB

Figure 21. Analog Output Bandwidth (Passband)

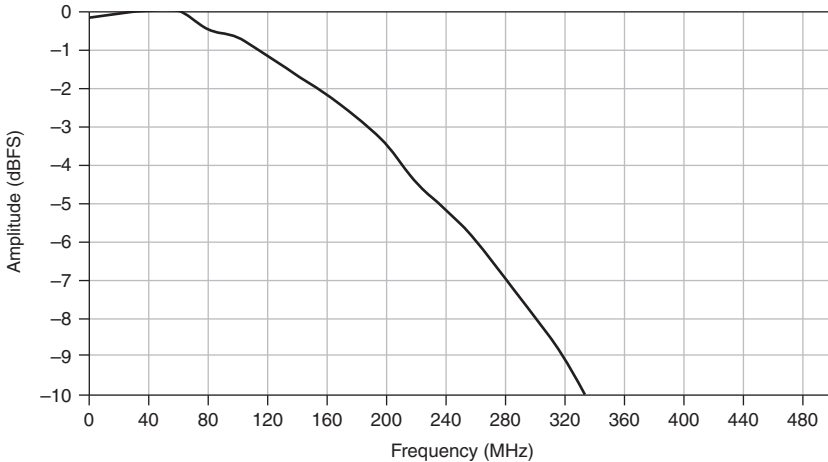

¹ Includes DAC sinc response.

Figure 22. Analog Output One-Tone Spectral Measurement (70 MHz, 0.25 dBm, 100 Hz Resolution Bandwidth, 100 kHz Bandwidth)

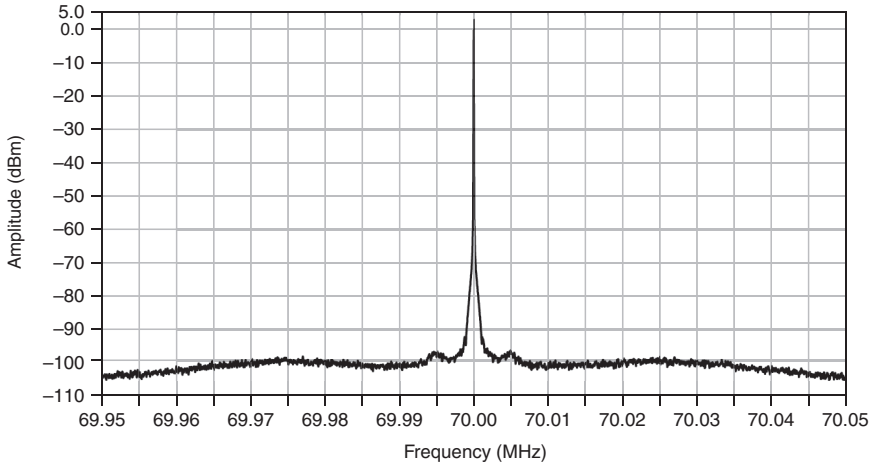

Figure 23. Analog Output One-Tone Spectral Measurement (70 MHz, 0.25 dBm, 1 kHz Resolution Bandwidth, 1 MHz Bandwidth)

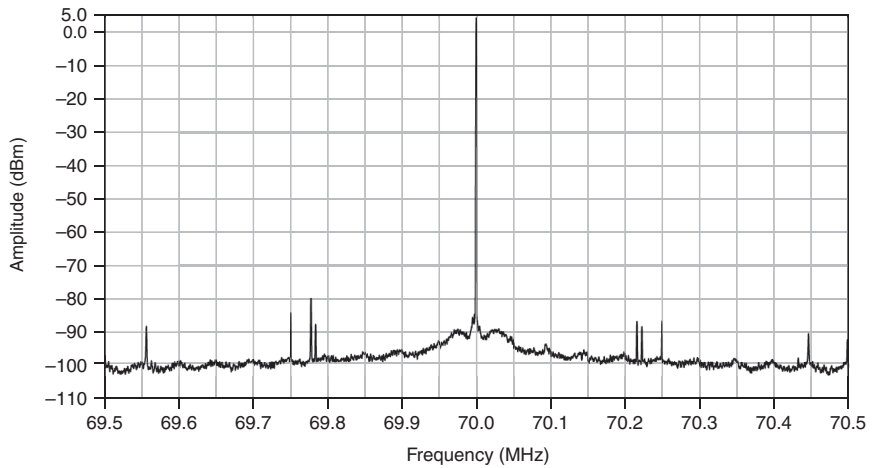

Figure 24. Analog Output One-Tone Spectral Measurement (70 MHz, 0.25 dBm, 1 kHz Resolution Bandwidth, 100 MHz Bandwidth)

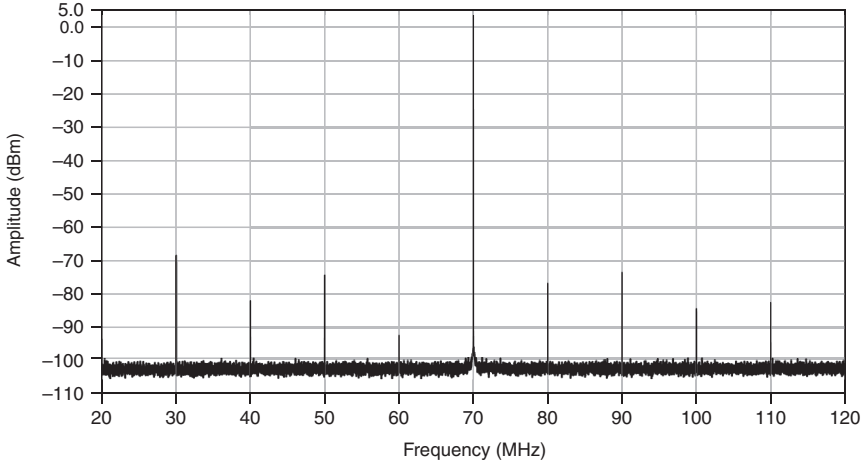
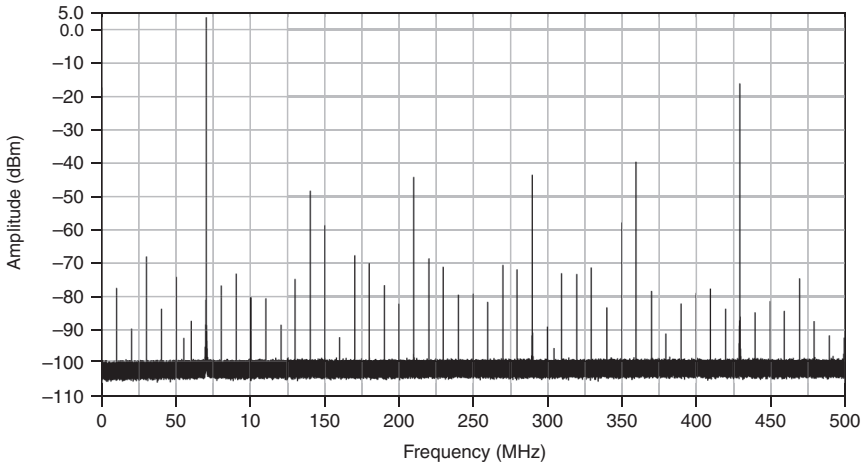

Figure 25. Analog Output One-Tone Spectral Measurement (70 MHz, 0.25 dBm, 1 kHz Resolution Bandwidth, 500 MHz Bandwidth)



Internal Sample Clock

General Characteristics

Oscillator type..... Fixed frequency synthesizer
 Frequency (default)..... 1 GHz
 Reference spurs..... <60 dBc

Phase noise	
10 kHz offset.....	-95 dBc/Hz
100 kHz offset.....	-115 dBc/Hz
Clock distribution part number.....	AD9512 ¹
Reference Clock sources	Internal, External through the CLK IN connector, or IoModSyncClock ²
Internal reference type.....	TCXO
Internal reference stability.....	±1 ppm
Internal reference frequency (default).....	10 MHz
Internal reference phase noise	
1 kHz offset.....	-137 dBc/Hz
10 kHz offset.....	-150 dBc/Hz
100 kHz offset.....	-155 dBc/Hz

CLK IN

General Characteristics

Number of channels.....	1, single-ended
Connector.....	SMA
Input impedance	50 Ω
Input coupling.....	AC

External Sample Clock

Input voltage range	0.63 V _{pk-pk} to 2.5 V _{pk-pk}
Input frequency range.....	250 MHz to 1 GHz
Absolute maximum input	±10 V DC, 3.1 V _{pk-pk} AC
Input power (50 Ω).....	0 dBm to 12 dBm

External Reference Clock

Input voltage range	1.4 V _{pk-pk} to 4.4 V _{pk-pk}
Input frequency range.....	10 MHz
Absolute maximum input	±10 V DC, 5 V _{pk-pk} AC
Input power (50 Ω).....	7.0 dBm to 16.8 dBm

¹ For additional information about the AD9512, refer to the Analog Devices device data sheet at www.analog.com.

² IoModSyncClock is available only on NI PXIe-796xR FPGA modules.

TRIG

General Characteristics

Number of channels 1, single-ended
Connector SMA
Input impedance 10k Ω
Input coupling DC

Table 9. Input Levels

Voltage Level	Minimum	Maximum
V_{IL}	0.0 V	0.8 V
V_{IH}	2.0 V	3.6 V

Absolute maximum input ± 10 V

AUX I/O (Port 0 DIO <0..3>, Port 1 DIO <0..3>, and PFI <0..3>)

General Characteristics

Number of channels 12 bidirectional (8 DIO and 4 PFI)
Connector type HDMI
Interface standard 3.3 V LVCMOS

Interface logic

Maximum V_{IL} 0.8 V
Minimum V_{IL} -0.3 V
Minimum V_{IH} 2.0 V
Maximum V_{IH} 3.6 V
Maximum V_{OL} 0.4 V
Minimum V_{OL} 0 V
Minimum V_{OH} 2.7 V
Maximum V_{OH} 3.6 V

Z_{out} 50 $\Omega \pm 20\%$

I_{out} (DC) ± 2 mA

Pull-down resistor 150 k Ω
Recommended operating voltage -0.3 V to 3.6 V
Overvoltage protection ± 10 V
Maximum toggle frequency 6.6 MHz

+5 V maximum power..... 10 mA
 +5 V voltage tolerance..... 4 V to 5.0 V

EEPROM

Table 10. EEPROM Map

Byte Address	Size (Bytes)	Field Name
0x0	2	Vendor ID
0x2	2	Product ID
0x4	4	Serial Number
0x8	116	Reserved
0x7C	132	User Space



Caution Only write to *User Space*. Writing to any other offset may cause the NI 5782 to stop functioning.

Power

Power draw (W)

AC-coupled build 4.59
 DC-coupled build 5.26

DC Power Requirements

VCCOA, VCCOB 2.37 V to 2.60 V
 VEEPROM 2.50 V to 5.50 V
 P33V 3.09 V to 3.47 V
 P12V 11.12 V to 12.60 V

Physical

Dimensions 11.4 × 10.2 × 2.00 cm
 (4.5 × 4.0 × 0.8 in.)
 Weight..... 317.5 g (11.2 oz)

Environmental

Operating environment ¹	0 °C to 55 °C, tested in accordance with IEC-60068-2-1 and IEC-60068-2-2.
Relative humidity range	10% to 90%, noncondensing, tested in accordance with IEC-60068-2-56.
Maximum altitude	2,000 m at 25 °C ambient temperature.
Pollution Degree	2
Indoor use only.	
Storage environment	
Ambient temperature range	-20 °C to 70 °C, tested in accordance with IEC-60068-2-1 and IEC-60068-2-2.
Relative humidity range	5% to 95%, noncondensing, tested in accordance with IEC-60068-2-56.



Note Clean the device with a soft, non-metallic brush. Make sure that the device is completely dry and free from contaminants before returning it to service.

Shock and Vibration

Operational shock	30 g peak, half-sine, 11 ms pulse, tested in accordance with IEC-60068-2-27. Test profile developed in accordance with MIL-PRF-28800F.
Random vibration	
Operating	5 Hz to 500 Hz, 0.3 g _{rms}
Nonoperating	5 Hz to 500 Hz, 2.4 g _{rms} , tested in accordance with IEC-60068-2-64. Nonoperating test profile exceeds the requirements of MIL-PRF-28800F, Class 3.

Safety

This product meets the requirements of the following standards of safety for electrical equipment for measurement, control, and laboratory use:

- IEC 61010-1, EN 61010-1
- UL 61010-1, CSA 61010-1

¹ For PXI/PXI Express chassis configurations that group NI FlexRIO adapter modules in three or more contiguous slots, National Instruments recommends limiting the ambient operating temperature to less than 50 °C.



Note For UL and other safety certifications, refer to the product label or the *Online Product Certification* section.

Electromagnetic Compatibility

This product meets the requirements of the following EMC standards for electrical equipment for measurement, control, and laboratory use:

- EN 61326-1 (IEC 61326-1): Class A emissions; Basic immunity
- EN 55011 (CISPR 11): Group 1, Class A emissions
- AS/NZS CISPR 11: Group 1, Class A emissions
- FCC 47 CFR Part 15B: Class A emissions
- ICES-001: Class A emissions



Note In the United States (per FCC 47 CFR), Class A equipment is intended for use in commercial, light-industrial, and heavy-industrial locations. In Europe, Canada, Australia, and New Zealand (per CISPR 11), Class A equipment is intended for use only in heavy-industrial locations.



Note Group 1 equipment (per CISPR 11) is any industrial, scientific, or medical equipment that does not intentionally generate radio frequency energy for the treatment of material or inspection/analysis purposes.



Note For EMC declarations and certifications, refer to the *Online Product Certification* section of this document.

CE Compliance

This product meets the essential requirements of applicable European Directives as follows:

- 2006/95/EC; Low-Voltage Directive (safety)
- 2004/108/EC; Electromagnetic Compatibility Directive (EMC)

Online Product Certification

To obtain product certifications and the Declaration of Conformity for this product, visit ni.com/certification, search by model number or product line, and click the appropriate link in the Certification column.

Environmental Management

NI is committed to designing and manufacturing products in an environmentally responsible manner. NI recognizes that eliminating certain hazardous substances from our products is beneficial to the environment and to NI customers.

For additional environmental information, refer to the *Minimize Our Environmental Impact* web page at ni.com/environment. This page contains the environmental regulations and directives

with which NI complies, as well as other environmental information not included in this document.

Waste Electrical and Electronic Equipment (WEEE)



EU Customers At the end of the product life cycle, all products *must* be sent to a WEEE recycling center. For more information about WEEE recycling centers, National Instruments WEEE initiatives, and compliance with WEEE Directive 2002/96/EC on Waste and Electronic Equipment, visit ni.com/environment/weee.

电子信息产品污染控制管理办法（中国 RoHS）



中国客户 National Instruments 符合中国电子信息产品中限制使用某些有害物质指令 (RoHS)。关于 National Instruments 中国 RoHS 合规性信息，请登录 ni.com/environment/rohs_china。(For information about China RoHS compliance, go to ni.com/environment/rohs_china.)

Appendix B: Installing EMI Controls

To ensure specified EMC performance, an HDMI cable ferrite and PXI EMC filler panels must be properly installed in your NI FlexRIO system. Your kit includes the HDMI cable ferrite, but the PXI EMC filler panels (National Instruments part number 778700-01) must be purchased separately. For more installation information, refer to the *NI FlexRIO FPGA Module Installation Guide and Specifications*.

Installing PXI EMC Filler Panels

Complete the following instructions to install PXI EMC filler panels (National Instruments part number 778700-01) in your PXI chassis:

1. Remove the captive screw covers.
2. Install the PXI EMC filler panels by securing the captive mounting screws to the chassis, as shown in the figure below. Make sure that the EMC gasket is on the right side of the PXI EMC filler panel.

Figure 26. PXI EMC Filler Panels and Chassis

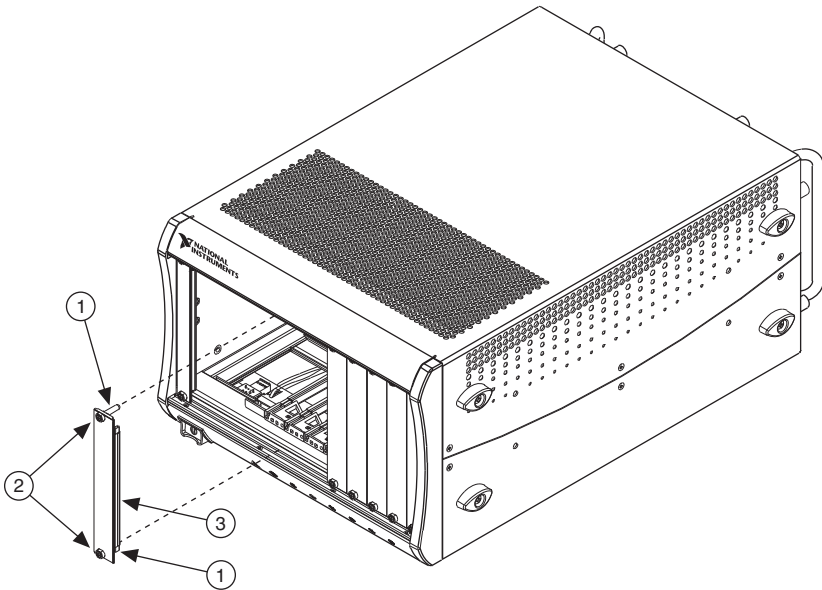

-
- | | | | | | |
|---|----------------------|---|-------------------------|---|------------|
| 1 | Captive Screw Covers | 2 | Captive Mounting Screws | 3 | EMC Gasket |
|---|----------------------|---|-------------------------|---|------------|
-



Note You must populate all slots with a module or a PXI EMC filler panel to ensure proper module cooling. Do not over tighten screws (2.5 lb-inch maximum). For additional information about the use of PXI EMC filler panels in your PXI system, visit ni.com/info and enter `emcpanels`.

Where to Go for Support

The National Instruments website is your complete resource for technical support. At ni.com/support you have access to everything from troubleshooting and application development self-help resources to email and phone assistance from NI Application Engineers.

A Declaration of Conformity (DoC) is our claim of compliance with the Council of the European Communities using the manufacturer's declaration of conformity. This system affords the user protection for electromagnetic compatibility (EMC) and product safety. You can obtain the DoC for your product by visiting ni.com/certification. If your product supports calibration, you can obtain the calibration certificate for your product at ni.com/calibration.

National Instruments corporate headquarters is located at 11500 North Mopac Expressway, Austin, Texas, 78759-3504. National Instruments also has offices located around the world to help address your support needs. For telephone support in the United States, create your service request at ni.com/support and follow the calling instructions or dial 512 795 8248. For telephone support outside the United States, visit the Worldwide Offices section of ni.com/niglobal to access the branch office websites, which provide up-to-date contact information, support phone numbers, email addresses, and current events.

LabVIEW, National Instruments, NI, ni.com, the National Instruments corporate logo, and the Eagle logo are trademarks of National Instruments Corporation. Refer to the *Trademark Information* at ni.com/trademarks for other National Instruments trademarks. Other product and company names mentioned herein are trademarks or trade names of their respective companies. For patents covering National Instruments products/technology, refer to the appropriate location: **Help»Patents** in your software, the `patents.txt` file on your media, or the *National Instruments Patents Notice* at ni.com/patents. You can find information about end-user license agreements (EULAs) and third-party legal notices in the NI 5782 Readme. Refer to the *Export Compliance Information* at ni.com/legal/export-compliance for the National Instruments global trade compliance policy and how to obtain relevant HTS codes, ECCNs, and other import/export data.

© 2013 National Instruments. All rights reserved.