

COMPREHENSIVE SERVICES

We offer competitive repair and calibration services, as well as easily accessible documentation and free downloadable resources.

SELL YOUR SURPLUS

We buy new, used, decommissioned, and surplus parts from every NI series. We work out the best solution to suit your individual needs.

 Sell For Cash  Get Credit  Receive a Trade-In Deal

OBSOLETE NI HARDWARE IN STOCK & READY TO SHIP

We stock **New**, **New Surplus**, **Refurbished**, and **Reconditioned** NI Hardware.



Bridging the gap between the manufacturer and your legacy test system.

 1-800-915-6216

 www.apexwaves.com

 sales@apexwaves.com

All trademarks, brands, and brand names are the property of their respective owners.

Request a Quote

 **CLICK HERE**

PXI-8155

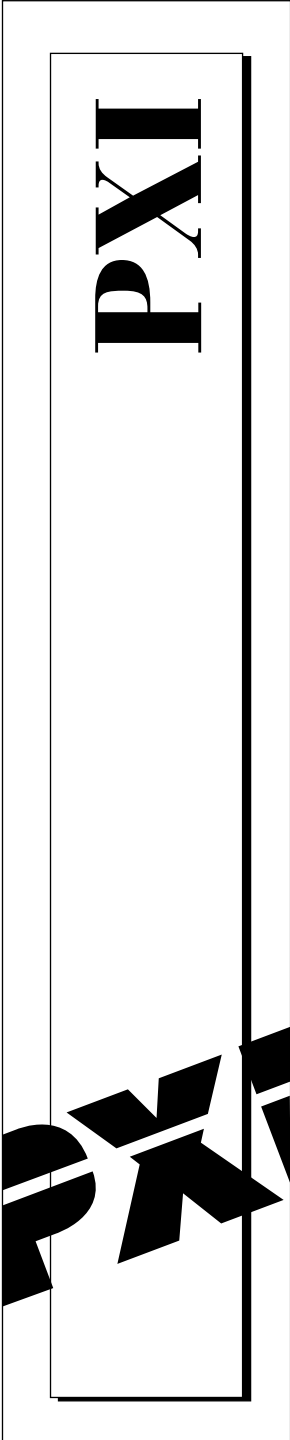
The PXI logo is presented in two ways. At the top, the letters 'P', 'X', and 'I' are stacked vertically in a bold, serif font, enclosed within a thin black rectangular border. At the bottom, a larger, stylized version of the 'PXI' logo is shown, appearing to be cut off by the left edge of the page. This version features a thick black outline and a white fill, with the letters overlapping each other.

PXI

Getting Started with Your PXI™-8150 Series for Windows 95/NT

October 1997 Edition
Part Number 321730A-01



Internet Support

support@natinst.com

E-mail: info@natinst.com

FTP Site: ftp.natinst.com

Web Address: <http://www.natinst.com>



Bulletin Board Support

BBS United States: (512) 794-5422

BBS United Kingdom: 01635 551422

BBS France: 01 48 65 15 59



Fax-on-Demand Support

(512) 418-1111

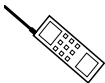

Telephone Support (U.S.)

Tel: (512) 795-8248

Fax: (512) 794-5678

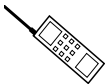

International Offices

Australia 03 9879 5166, Austria 0662 45 79 90 0, Belgium 02 757 00 20, Brazil 011 288 3336,
Canada (Ontario) 905 785 0085, Canada (Québec) 514 694 8521, Denmark 45 76 26 00,
Finland 09 725 725 11, France 01 48 14 24 24, Germany 089 741 31 30,
Hong Kong 2645 3186, Israel 03 6120092, Italy 02 413091, Japan 03 5472 2970,
Korea 02 596 7456, Mexico 5 520 2635, Netherlands 0348 433466, Norway 32 84 84 00,
Singapore 2265886, Spain 91 640 0085, Sweden 08 730 49 70, Switzerland 056 200 51 51,
Taiwan 02 377 1200, United Kingdom 01635 523545

National Instruments Corporate Headquarters

6504 Bridge Point Parkway Austin, TX 78730-5039 Tel: (512) 794-0100

Important Information

Warranty

The PXI-8150 Series of embedded PXI computers are warranted against defects in materials and workmanship for a period of one year from the date of shipment, as evidenced by receipts or other documentation. National Instruments will, at its option, repair or replace equipment that proves to be defective during the warranty period. This warranty includes parts and labor.

The media on which you receive National Instruments software are warranted not to fail to execute programming instructions, due to defects in materials and workmanship, for a period of 90 days from date of shipment, as evidenced by receipts or other documentation. National Instruments will, at its option, repair or replace software media that do not execute programming instructions if National Instruments receives notice of such defects during the warranty period. National Instruments does not warrant that the operation of the software shall be uninterrupted or error free.

A Return Material Authorization (RMA) number must be obtained from the factory and clearly marked on the outside of the package before any equipment will be accepted for warranty work. National Instruments will pay the shipping costs of returning to the owner parts which are covered by warranty.

National Instruments believes that the information in this manual is accurate. The document has been carefully reviewed for technical accuracy. In the event that technical or typographical errors exist, National Instruments reserves the right to make changes to subsequent editions of this document without prior notice to holders of this edition. The reader should consult National Instruments if errors are suspected. In no event shall National Instruments be liable for any damages arising out of or related to this document or the information contained in it.

EXCEPT AS SPECIFIED HEREIN, NATIONAL INSTRUMENTS MAKES NO WARRANTIES, EXPRESS OR IMPLIED, AND SPECIFICALLY DISCLAIMS ANY WARRANTY OF MERCHANTABILITY OR FITNESS FOR A PARTICULAR PURPOSE. CUSTOMER'S RIGHT TO RECOVER DAMAGES CAUSED BY FAULT OR NEGLIGENCE ON THE PART OF NATIONAL INSTRUMENTS SHALL BE LIMITED TO THE AMOUNT THEREFORE PAID BY THE CUSTOMER. NATIONAL INSTRUMENTS WILL NOT BE LIABLE FOR DAMAGES RESULTING FROM LOSS OF DATA, PROFITS, USE OF PRODUCTS, OR INCIDENTAL OR CONSEQUENTIAL DAMAGES, EVEN IF ADVISED OF THE POSSIBILITY THEREOF. This limitation of the liability of National Instruments will apply regardless of the form of action, whether in contract or tort, including negligence. Any action against National Instruments must be brought within one year after the cause of action accrues. National Instruments shall not be liable for any delay in performance due to causes beyond its reasonable control. The warranty provided herein does not cover damages, defects, malfunctions, or service failures caused by owner's failure to follow the National Instruments installation, operation, or maintenance instructions; owner's modification of the product; owner's abuse, misuse, or negligent acts; and power failure or surges, fire, flood, accident, actions of third parties, or other events outside reasonable control.

Copyright

Under the copyright laws, this publication may not be reproduced or transmitted in any form, electronic or mechanical, including photocopying, recording, storing in an information retrieval system, or translating, in whole or in part, without the prior written consent of National Instruments Corporation.

Trademarks

CVI™, LabVIEW™, NI-488.2™, NI-488.2M™, NI-DAQ™, NI-VISA™, PXI™, and TNT4882C™ are trademarks of National Instruments Corporation.

Product and company names listed are trademarks or trade names of their respective companies.

WARNING REGARDING MEDICAL AND CLINICAL USE OF NATIONAL INSTRUMENTS PRODUCTS

National Instruments products are not designed with components and testing intended to ensure a level of reliability suitable for use in treatment and diagnosis of humans. Applications of National Instruments products involving medical or clinical treatment can create a potential for accidental injury caused by product failure, or by errors on the part of the user or application designer. Any use or application of National Instruments products for or involving medical or clinical treatment must be performed by properly trained and qualified medical personnel, and all traditional medical safeguards, equipment, and procedures that are appropriate in the particular situation to prevent serious injury or death should always continue to be used when National Instruments products are being used. National Instruments products are NOT intended to be a substitute for any form of established process, procedure, or equipment used to monitor or safeguard human health and safety in medical or clinical treatment.

FCC/DOC Radio Frequency Interference Class A Compliance

This equipment generates and uses radio frequency energy and, if not installed and used in strict accordance with the instructions in this manual, may cause interference to radio and television reception. Classification requirements are the same for the Federal Communications Commission (FCC) and the Canadian Department of Communications (DOC). This equipment has been tested and found to comply with the following two regulatory agencies:

Federal Communications Commission

This equipment has been tested and found to comply with the limits for a Class A digital device, pursuant to part 15 of the FCC Rules. These limits are designed to provide reasonable protection against harmful interference when the equipment is operated in a commercial environment. This equipment generates, uses, and can radiate radio frequency energy and, if not installed and used in accordance with the instruction manual, may cause harmful interference to radio communications. Operation of this equipment in a residential area is likely to cause harmful interference in which case the user will be required to correct the interference at his own expense.

Notices to User: *Changes or modifications not expressly approved by National Instruments could void the user's authority to operate the equipment under the FCC Rules.*

This device complies with the FCC rules only if used with shielded interface cables of suitable quality and construction. National Instruments used such cables to test this device and provides them for sale to the user. The use of inferior or nonshielded interface cables could void the user's authority to operate the equipment under the FCC rules.

If necessary, consult National Instruments or an experienced radio/television technician for additional suggestions. The following booklet prepared by the FCC may also be helpful: *Interference to Home Electronic Entertainment Equipment Handbook*. This booklet is available from the U.S. Government Printing Office, Washington, DC 20402.

Canadian Department of Communications

This Class A digital apparatus meets all requirements of the Canadian Interference-Causing Equipment Regulations.

Cet appareil numérique de la classe A respecte toutes les exigences du Règlement sur le matériel brouilleur du Canada.



*Table
of
Contents*

About This Manual

Organization of This Manual	vii
Conventions Used in This Manual	vii
How to Use This Documentation Set	viii
Related Documentation	ix
Customer Communication	ix

Chapter 1

Introduction

What You Need to Get Started	1-1
Hardware Description	1-1
Software Description	1-2
National Instruments Application Software	1-2
Files and Directories Installed on Your Hard Drive	1-3

Chapter 2

Setup

Hardware Installation	2-1
Setting up the PXI-8150	2-3

Appendix A

Default Settings

Appendix B

Customer Communication

Glossary

Figure

Figure 2-1. PXI Mainframe and Controller.....	2-3
---	-----

Table

Table A-1. PXI-8150 Series Hardware Default Settings.....	A-1
---	-----

You can use this manual to get a quick start with the PXI-8150 Series embedded computers. This manual summarizes the setup instructions and default settings. You may find these sections contain all the information you need to get started with your PXI-8150 kit.

Organization of This Manual

This manual is organized as follows:

- Chapter 1, *Introduction*, describes the PXI-8150 Series of embedded PXI computers, lists what you need to get started, lists optional software, and gives an overview of the directory structure on your hard drive.
- Chapter 2, *Setup*, contains basic instructions for setting up the PXI-8150 embedded computer.
- Appendix A, *Default Settings*, summarizes the hardware default settings for the PXI-8150 Series kits.
- Appendix B, *Customer Communication*, contains forms you can use to request help from National Instruments or to comment on our products and manuals.
- The *Glossary* contains an alphabetical list and description of terms used in this manual, including abbreviations, acronyms, metric prefixes, mnemonics, and symbols.

Conventions Used in This Manual

The following conventions are used in this manual:



This icon to the left of bold italicized text denotes a caution, which advises you of precautions to take to avoid injury, data loss, or a system crash.



This icon to the left of bold italicized text denotes a warning, which advises you of precautions to take to avoid being electrically shocked.

<i>bold italic</i>	Bold italic text denotes a caution or warning.
<i>italic</i>	Italic text denotes emphasis, a cross reference, or an introduction to a key concept.
monospace	Text in this font denotes the proper names of disk drives, paths, directories, filenames and extensions.

How to Use This Documentation Set

Begin by reading this manual, *Getting Started with Your PXI™-8150 Series for Windows 95/NT*, for basic instructions on setting up the PXI-8150. This is a brief quick-start manual that describes how to get started with your kit using the default settings.

The *PXI-8150 Series User Manual* contains more details about changing the hardware installation or configuration from the defaults, and using the hardware.

Refer to the *NI-VISA User Manual* to learn about VISA and how to use it in your system. The NI-VISA online help describes the attributes, events, and operations you can use in NI-VISA. You can find this same information in the *NI-VISA Programmer Reference Manual*. These two manuals are available in the `c:\Vxipnp\WinXX\NIvisa\Manuals` directory (where `WinXX` is either `Win95` or `WinNT`) under the names `NI-VISAUsersMan.pdf` and `NI-VISAProgrammersMan.pdf`. Use the Acrobat Reader program, Version 3 or later, to open these files.

PXI-8156 users receive the NI-488.2M software kit, which includes the *NI-488.2M User Manual for Windows 95 and Windows NT* and the *NI-488.2M Function Reference Manual for Win32*. PXI-8155 users can get this kit by ordering a PXI-GPIB interface module.

If you ordered either LabVIEW or LabWindows™/CVI, you receive full documentation along with a configuration disk to unlock and access these application programming environments, which are already installed on your hard drive.

Related Documentation

The following documents contain information that you may find helpful as you read this manual:

- *PICMG 2.0 R2.1 CompactPCI Specification*, PCI Industrial Computers Manufacturers Group
- IEEE Standard P1284.1-1997 (*C/MM*) *Standard for Information Technology for Transport Independent Printer/System Interface*
- *PCI Local Bus Specification*, Revision 2.1, PCI Special Interest Group
- *PXI Specification*, Revision 1.0, National Instruments Corporation
- *Serialized IRQ Support for PCI Systems Specification*, Revision 6.0, Compaq Computer et al.

Customer Communication

National Instruments wants to receive your comments on our products and manuals. We are interested in the applications you develop with our products, and we want to help if you have problems with them. To make it easy for you to contact us, this manual contains comment and configuration forms for you to complete. These forms are in Appendix B, *Customer Communication*, at the end of this manual.

Introduction

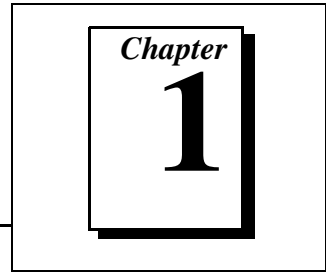

This chapter describes the PXI-8150 Series of embedded PXI computers, lists what you need to get started, lists optional software, and gives an overview of the directory structure on your hard drive.

What You Need to Get Started

- PXI-8150 Series embedded controller
- PXI bus mainframe
- Keyboard (and included adapter cable)
- Serial or PS/2 mouse
- Monitor with VGA or better resolution

Hardware Description

The PXI-8150 Series are 3U-size embedded PXI computers based on the Peripheral Component Interface (PCI) bus and Industry-Standard Architecture (ISA). These embedded computers are high-performance, easy-to-use platforms that take advantage of the PXI high-performance backplane capabilities to control PXI systems. These embedded computers.

All models in the PXI-8150 Series are compatible with PC-compatible software tools, the National Instruments LabVIEW and LabWindows/CVI application software, and the NI-VISA, NI-488.2M, and NI-DAQ driver software.

For in-depth details on the PXI-8150 hardware, consult the *PXI-8150 Series User Manual*.

Software Description

National Instruments has developed several software kits you can use with the PXI-8150 Series. The software is already installed on your hard drive.

You can use the NI-VISA high-level API to program GPIB, Serial, parallel, and PXI devices in much the same manner. The NI-VISA kit includes installation disks you can use if you need to reinstall the software, and the *NI-VISA User Manual*.

The NI-488.2M software kit is the industry standard for controlling external GPIB instruments through the GPIB port on the PXI-8156 front panel. The software is already installed on your hard drive, and you also receive backup installation disks and the *NI-488.2M User Manual for Windows 95 and Windows NT* and the *NI-488.2M Function Reference Manual for Win32*.

The GPIB interface is fully compatible with the NI-488.2M driver for a variety of operating systems. Any software using NI-488.2M will run on the PXI-8150.

National Instruments Application Software

You can use the National Instruments LabVIEW and LabWindows/CVI application programs and instrument drivers to ease your programming tasks. These standardized programs match the modular virtual instrument capability of PXI and can reduce your application development time. These programs are fully *VXIplug&play* compliant and feature extensive libraries of GPIB, Serial, and VXI instrument drivers written to take full advantage of direct PXI control. LabVIEW and LabWindows/CVI include all the tools needed for instrument control, data acquisition, analysis, and presentation.

LabVIEW is a complete programming environment that departs from the sequential nature of traditional programming languages and features a graphical programming environment.

LabWindows/CVI is an interactive C development environment for building test and measurement and instrument control systems. It includes interactive code-generation tools and a graphical editor for building custom user interfaces.

If you ordered LabVIEW or LabWindows/CVI, you received a configuration disk to access either or both of these application programming environments. Refer to Chapter 2, *Setup*, for more information. You also received all the necessary libraries to support your PXI-8150 and hundreds of complete instrument drivers, which are modular, source-code programs that handle the communication with your instrument to speed your application development.

Files and Directories Installed on Your Hard Drive

Your hard drive includes a directory called `images` in its root that contains software and soft copies of manuals for the operating system and peripherals. The directory structure under the `images` directory is logically organized into several levels.

In the `images` directory itself, you will find a `manuals` directory, an `os` directory, and directories for each of the peripherals of your computer.

The `manuals` directory contains quick reference guides, technical reference manuals, and National Instruments software manuals, all in Adobe Acrobat format. To access any of these manuals, change your directory to `c:\images\pxi815x>manuals` and list the contents of that directory. You will see several files, one corresponding to each peripheral.

The `os` directory contains a subdirectory corresponding to the operating system installed on your computer. That subdirectory contains an image of the CD from which your operating system was installed, so you do not need to insert the CD when you install a new peripheral. When the software prompts you to insert the CD, simply direct the system to look in the `images\os` directory instead.

For example, if your system has Windows 95 installed, you should find an image of the Windows 95 CD in `c:\images\os\win95`.

The rest of the directories correspond to each of the peripherals in your system. Within each of these directories are the drivers for the peripherals. These files and directories are copied exactly from the distribution disks of the manufacturers, so the naming conventions vary from peripheral to peripheral.

Because the naming conventions may not be completely straightforward, National Instruments provides a text file named `drivers.txt` in the `c:\images\pxi815x` directory. The `drivers.txt` file explains how to install support for each peripheral. You may want to print this file for reference when you install your peripheral device drivers.

Setup

Chapter

2

This chapter contains basic instructions for setting up the PXI-8150 embedded computer.

You can use this material as a guide to quickly configure and operate your PXI system using the PXI-8150. This chapter assumes that you intend to perform a basic configuration as follows:

- You have one PXI mainframe in which you will be using the PXI-8150.
- You will use the default settings.

Refer to Appendix A, *Default Settings*, for a complete listing of the default settings. If you need more information, or if you want to try a different configuration, please refer to the *PXI-8150 Series User Manual* for information about the hardware, or to the National Instruments software manuals you received with your kit.

Hardware Installation



Caution: *To prevent electrostatic discharge, touch the antistatic plastic package to a metal part of your PXI mainframe before removing the PXI-8150 from the package.*

1. Plug in your mainframe before installing the PXI-8150. The power cord grounds the mainframe and protects it from electrical damage while you install the module.



Warning: *To protect both yourself and the mainframe from electrical hazards, leave the mainframe off until you finish installing the PXI-8150 module.*

2. Remove or open any doors or covers blocking access to the system controller slot (Slot 1) in the mainframe.
3. Make sure the injector/ejector handle is in its downward position. Align the PXI-8150 with the card guides on the top and bottom of the system controller slot.



Caution: *Do not raise the injector/ejector handle as you insert the PXI-8150. The module will not insert properly unless the handle is in its downward position so that it does not interfere with the injector/ejector rail on the mainframe.*

4. Hold the handle as you slowly slide the module into the mainframe until the handle catches on the injector/ejector rail.
5. Raise the injector/ejector handle until the module firmly seats into the backplane receptacle connectors. The front panel of the PXI-8150 should be even with the front panel of the mainframe.
6. Tighten the four bracket-retaining screws on the top and bottom of the front panel to secure the PXI-8150 to the mainframe.
7. Check the installation.
8. Connect the keyboard and mouse to the appropriate connectors. Use the keyboard adapter cable that you received with your kit if you need to adapt an AT-style keyboard to the PXI-8150 mini-DIN connector.
9. Connect the VGA monitor video cable to the VGA connector.
10. Connect devices to ports as required by your system configuration. Some ports, such as the Parallel port, have adapter cables that you can order from National Instruments.
11. Replace or close any doors or covers to the mainframe.

Figure 2-1 shows a PXI-8156 installed in the system controller slot of a National Instruments PXI-1000 mainframe. You can place PXI devices in any of the peripheral slots, which are numbered 2 through 8.

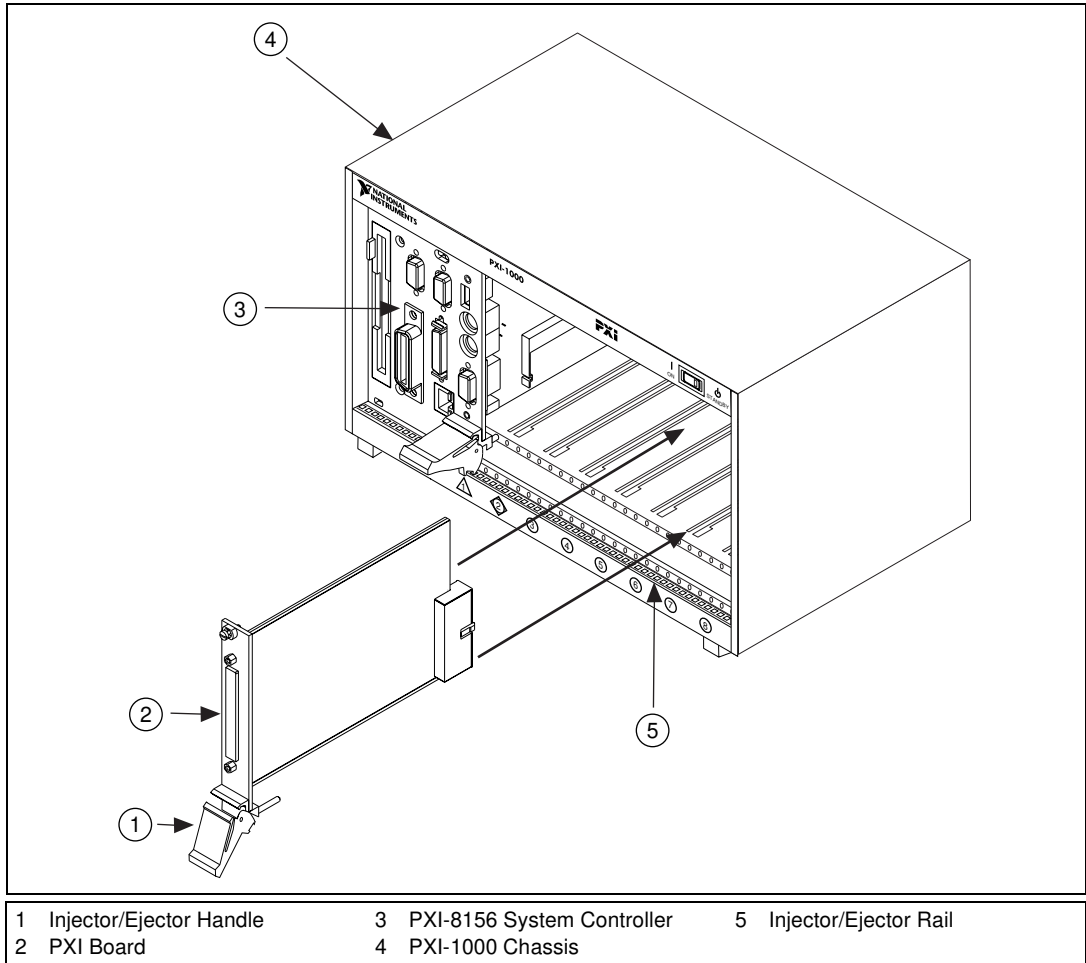

Figure 2-1. PXI Mainframe and Controller

Setting up the PXI-8150

At Windows 95/NT startup, the software prompts you to insert a disk to configure the system for LabVIEW or LabWindows/CVI, and to enter the serial number for the operating system. These programming environments are already installed on your system but you must insert a configuration disk when prompted so that you can access and use them. If you ordered either of these programming environments, select

the appropriate checkbox and insert the configuration disk. Follow the instructions as prompted.

Do not select either checkbox if you did not order LabVIEW or LabWindows/CVI. Continue with the rest of the Setup program.

The PXI-8150 comes with the NI-488.2M and NI-VISA software already installed. However, if you need to reinstall NI-VISA in the event that your files were accidentally erased, use the Setup program and follow the prompts to install these programs from the diskettes. The PXI-8156 kit also includes backup disks for NI-488.2M.

Similarly, if you need to reinstall LabVIEW or LabWindows/CVI, use the CD or diskette package that came with these programs.

Default Settings

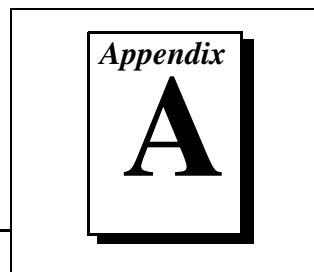

This appendix summarizes the hardware default settings for the PXI-8150 Series kits. If you need more information about a particular setting or if you want to try a different configuration, refer to the *PXI-8150 Series User Manual*.

Table A-1. PXI-8150 Series Hardware Default Settings

Hardware Component	Default Setting
W1 (CPU Board) CMOS Clear	Disabled (Normal CMOS operation)
W3 (CPU Board) INTS Connection	Serial IRQ Connected to INTS
W4 (CPU Board) INTP Connection	No Connection to INTP
W1 (I/O Board) Ethernet EEPROM (PXI-8156 only)	Enabled. <i>Do not alter this setting.</i>
Ethernet Settings (PXI-8156 only)	I/O Address = 0x300 IRQ = 9
GPIB Settings (PXI-8156 only)	I/O Address = 0x2c0 IRQ = 11 DMA = Disabled

Customer Communication

Appendix

B

For your convenience, this appendix contains forms to help you gather the information necessary to help us solve your technical problems and a form you can use to comment on the product documentation. When you contact us, we need the information on the Technical Support Form and the configuration form, if your manual contains one, about your system configuration to answer your questions as quickly as possible.

National Instruments has technical assistance through electronic, fax, and telephone systems to quickly provide the information you need. Our electronic services include a bulletin board service, an FTP site, a Fax-on-Demand system, and e-mail support. If you have a hardware or software problem, first try the electronic support systems. If the information available on these systems does not answer your questions, we offer fax and telephone support through our technical support centers, which are staffed by applications engineers.

Electronic Services



Bulletin Board Support

National Instruments has BBS and FTP sites dedicated for 24-hour support with a collection of files and documents to answer most common customer questions. From these sites, you can also download the latest instrument drivers, updates, and example programs. For recorded instructions on how to use the bulletin board and FTP services and for BBS automated information, call (512) 795-6990. You can access these services at:

United States: (512) 794-5422

Up to 14,400 baud, 8 data bits, 1 stop bit, no parity

United Kingdom: 01635 551422

Up to 9,600 baud, 8 data bits, 1 stop bit, no parity

France: 01 48 65 15 59

Up to 9,600 baud, 8 data bits, 1 stop bit, no parity



FTP Support

To access our FTP site, log on to our Internet host, `ftp.natinst.com`, as anonymous and use your Internet address, such as `joesmith@anywhere.com`, as your password. The support files and documents are located in the `/support` directories.



Fax-on-Demand Support

Fax-on-Demand is a 24-hour information retrieval system containing a library of documents on a wide range of technical information. You can access Fax-on-Demand from a touch-tone telephone at (512) 418-1111.



E-Mail Support (currently U.S. only)

You can submit technical support questions to the applications engineering team through e-mail at the Internet address listed below. Remember to include your name, address, and phone number so we can contact you with solutions and suggestions.

support@natinst.com

Telephone and Fax Support

National Instruments has branch offices all over the world. Use the list below to find the technical support number for your country. If there is no National Instruments office in your country, contact the source from which you purchased your software to obtain support.

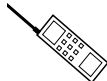

Telephone



Fax

Australia	03 9879 5166	03 9879 6277
Austria	0662 45 79 90 0	0662 45 79 90 19
Belgium	02 757 00 20	02 757 03 11
Brazil	011 288 336	011 288 8528
Canada (Ontario)	905 785 0085	905 785 0086
Canada (Quebec)	514 694 8521	514 694 4399
Denmark	45 76 26 00	45 76 26 02
Finland	09 725 725 11	09 725 725 55
France	01 48 14 24 24	01 48 14 24 14
Germany	089 741 31 30	089 714 60 35
Hong Kong	2645 3186	2686 8505
Israel	03 6120092	03 6120095
Italy	02 413091	02 41309215
Japan	03 5472 2970	03 5472 2977
Korea	02 596 7456	02 596 7455
Mexico	5 520 2635	5 520 3282
Netherlands	0348 433466	0348 430673
Norway	32 84 84 00	32 84 86 00
Singapore	2265886	2265887
Spain	91 640 0085	91 640 0533
Sweden	08 730 49 70	08 730 43 70
Switzerland	056 200 51 51	056 200 51 55
Taiwan	02 377 1200	02 737 4644
United Kingdom	01635 523545	01635 523154
United States	512 795 8248	512 794 5678

Technical Support Form

Photocopy this form and update it each time you make changes to your software or hardware, and use the completed copy of this form as a reference for your current configuration. Completing this form accurately before contacting National Instruments for technical support helps our applications engineers answer your questions more efficiently.

If you are using any National Instruments hardware or software products related to this problem, include the configuration forms from their user manuals. Include additional pages if necessary.

Name _____

Company _____

Address _____

Fax (___) _____ Phone (___) _____

Computer brand _____ Model _____ Processor _____

Operating system (include version number) _____

Clock speed _____ MHz RAM _____ MB Display adapter _____

Mouse ___yes ___no Other adapters installed _____

Hard disk capacity _____ MB Brand _____

Instruments used _____

National Instruments hardware product model _____ Revision _____

Configuration _____

National Instruments software product _____ Version _____

Configuration _____

The problem is: _____

List any error messages: _____

The following steps reproduce the problem: _____

PXI-8150 Series Hardware and Software Configuration Form

Record the settings and revisions of your hardware and software on the line to the right of each item. Complete a new copy of this form each time you revise your software or hardware configuration, and use this form as a reference for your current configuration. Completing this form accurately before contacting National Instruments for technical support helps our applications engineers answer your questions more efficiently.

National Instruments Products

PXI-8150 Series Model Number _____

PXI-8150 Series Part Number _____

PXI-8150 Series Serial Number _____

Processor Speed _____

Clock Frequency or Speed _____

DRAM SO-DIMMs Installed _____

Hard Drive Size _____ Video Memory _____

W1 Setting: CMOS _____

W1 (I/O Board) Setting: Ethernet EEPROM (PXI-8156 only) _____

W3 Setting: INTS Connection _____

W4 Setting: INTP Connection _____

List National Instruments Software Installed and Version

NI-VISA Version _____

NI-488.2 Version _____

NI-DAQ Version _____

LabVIEW Version _____

LabWindows/CVI Version _____

Other National Instruments Software Version _____

Programming Choice _____

Other Products

Operating System Version _____

Operating System Mode _____

Programming Language _____

Programming Language Version _____

PXI Mainframe Manufacturer and Model _____

List Other Boards in PXI Mainframe

PXI Slot	Manufacturer, Description, and Function
2	
3	
4	
5	
6	
7	
8	

Documentation Comment Form

National Instruments encourages you to comment on the documentation supplied with our products. This information helps us provide quality products to meet your needs.

Title: *Getting Started with Your PXI™-8150 Series for Windows 95/NT*

Edition Date: October 1997

Part Number: 321730A-01

Please comment on the completeness, clarity, and organization of the manual.

If you find errors in the manual, please record the page numbers and describe the errors.

Thank you for your help.

Name _____

Title _____

Company _____

Address _____

Phone (___) _____ Fax (___) _____

Mail to: Technical Publications
National Instruments Corporation
6504 Bridge Point Parkway
Austin, TX 78730-5039

Fax to: Technical Publications
National Instruments Corporation
(512) 794-5678

Prefix	Meanings	Value
n-	nano-	10^{-9}
μ -	micro-	10^{-6}
m-	milli-	10^{-3}
K-	kilo-	10^3
M-	mega-	10^6
G-	giga-	10^9

A

ASIC application-specific integrated circuit

B

B bytes

backplane An assembly, typically a printed circuit board, with connectors and signal paths that bus the connector pins.

BIOS Basic Input/Output System. BIOS functions are the fundamental level of any PC or compatible computer. BIOS functions embody the basic operations needed for successful use of the computer's hardware resources.

C

CompactPCI An adaptation of the PCI specification for industrial and/or embedded applications that require a more robust mechanical form factor than desktop PCI. CompactPCI provides a standard form factor for those applications requiring the high performance of PCI as well as the small size and ruggedness of a rack-mount system.

D

DIMM Dual In-line Memory Module

DMA Direct Memory Access; a method by which data is transferred between devices and internal memory without intervention of the central processing unit

DRAM Dynamic RAM (Random Access Memory); storage that the computer must refresh at frequent intervals

E

EEPROM Electronically Erasable Programmable Read Only Memory

embedded controller An intelligent CPU (controller) interface plugged directly into the PXI backplane, giving it direct access to the PXI bus. It must have all of its required PXI interface capabilities built in.

F

FCC Federal Communications Commission

G

GPIB General Purpose Interface Bus (IEEE 488)

H

Hz hertz; cycles per second

I

IDE	Integrated Drive Electronics; hard disk and built-in controller
IEEE	Institute of Electrical and Electronics Engineers
in.	inches
I/O	input/output; the techniques, media, and devices used to achieve communication between machines and users
instrument driver	A set of routines designed to control a specific instrument or family of instruments, and any necessary related files for LabWindows/CVI or LabVIEW
interrupt	A means for a device to request service from another device
interrupt level	The relative priority at which a device can interrupt
IRQ*	Interrupt signal
ISA	Industry Standard Architecture; the original PC bus architecture, specifically the 16-bit AT bus

K

KB	kilobytes of memory
----	---------------------

M

master	A functional part of a PXI device that initiates data transfers on the PXI backplane. A transfer can be either a read or a write.
MB	megabytes of memory

N

NI-488.2	The National Instruments software for GPIB systems
NI-DAQ	The National Instruments software for data acquisition instruments

NI-VISA The National Instruments implementation of the VISA standard; an interface-independent software that provides a unified programming interface for VXI, GPIB, and serial instruments

P

PCI Peripheral Component Interconnect. The PCI bus is a high-performance 32-bit or 64-bit bus with multiplexed address and data lines.

peripheral any hardware device connected to a computer, such as a monitor, keyboard, printer, plotter, disk or tape drive, graphics tablet, scanner, mouse, and so on

PXI PCI eXtensions for Instrumentation; an open implementation of CompactPCI that adds electrical features that meet the high-performance requirements of instrumentation applications by providing triggering, local buses, and system clock capabilities. PXI also offers two-way interoperability with CompactPCI products.

R

RAM Random Access Memory; the computer's primary workspace

S

s seconds

slave A functional part of a PXI device that detects data transfer cycles initiated by a PXI bus master and responds to the transfers when the address specifies one of the device's registers

SO-DIMM Small Outline Dual In-line Memory Module

Star Trigger Slot This slot is located at Slot 2 in a PXI mainframe and has a dedicated trigger line between each peripheral slot. This slot would be used for a module with ST functionality that can provide individual triggers to all other peripherals.