

## COMPREHENSIVE SERVICES

We offer competitive repair and calibration services, as well as easily accessible documentation and free downloadable resources.

## SELL YOUR SURPLUS

We buy new, used, decommissioned, and surplus parts from every NI series. We work out the best solution to suit your individual needs.

 Sell For Cash  Get Credit  Receive a Trade-In Deal

## OBSOLETE NI HARDWARE IN STOCK & READY TO SHIP

We stock **New**, **New Surplus**, **Refurbished**, and **Reconditioned** NI Hardware.



*Bridging the gap between the manufacturer and your legacy test system.*

 1-800-915-6216

 [www.apexwaves.com](http://www.apexwaves.com)

 [sales@apexwaves.com](mailto:sales@apexwaves.com)

*All trademarks, brands, and brand names are the property of their respective owners.*

**Request a Quote**

 **CLICK HERE**

**PXI-8196**

# NI 9157/9159

Reconfigurable Embedded Chassis with Integrated MXI-Express (x1)

Figure 1. NI 9157/9159 Front Panel

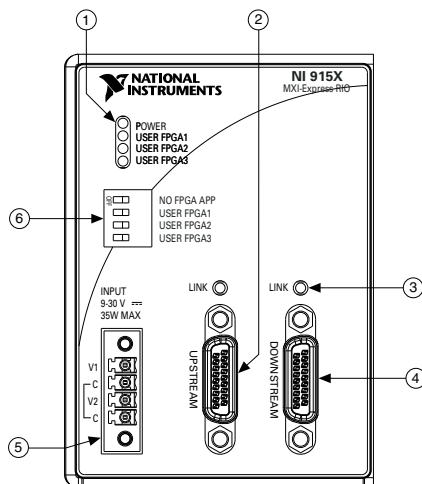

- |                          |                    |
|--------------------------|--------------------|
| 1. LEDs                  | 4. Downstream Port |
| 2. Upstream Port         | 5. Power Connector |
| 3. MXI-Express LINK LEDs | 6. DIP Switches    |

This document describes how to connect the NI 9157/9159 to a MXI-Express host and one or more other chassis, and how to use the features of the NI 9157/9159. This document also contains specifications for the NI 9157/9159.

## Safety Guidelines

Operate the NI 9157/9159 only as described in this document.



**Caution** Do not operate the NI 9157/9159 in a manner not specified in this document. Product misuse can result in a hazard. You can compromise the safety protection built into the product if the product is damaged in any way. If the product is damaged, return it to NI for repair.

## Safety Guidelines for Hazardous Locations

The NI 9157/9159 is suitable for use in Class I, Division 2, Groups A, B, C, D, T4 hazardous locations; Class I, Zone 2, AEx nA IIC T4 and Ex nA IIC T4 hazardous locations; and nonhazardous locations only. Follow these guidelines if you are installing the NI 9157/9159 in a potentially explosive environment. Not following these guidelines may result in serious injury or death.



**Caution** Do not disconnect the power supply wires and connectors from the controller unless power has been switched off.



**Caution** Do not disconnect I/O-side wires or connectors unless power has been switched off or the area is known to be nonhazardous.



**Caution** Do not remove modules unless power has been switched off or the area is known to be nonhazardous.



**Caution** Substitution of components may impair suitability for Class I, Division 2.



**Caution** For Division 2 and Zone 2 applications, install the system in an enclosure rated to at least IP54 as defined by IEC/EN 60079-15.

## Special Conditions for Hazardous Locations Use in Europe and Internationally

The NI 9157/9159 has been evaluated as Ex nA IIC T4 Gc equipment under DEMKO Certificate No. 07 ATEX 0626664X and is IECEx UL 14.0089X certified. Each device is marked Ⓜ II 3G and is suitable for use in Zone 2 hazardous locations, in ambient temperatures of  $0\text{ }^{\circ}\text{C} \leq T_a \leq 55\text{ }^{\circ}\text{C}$ .



**Caution** You must make sure that transient disturbances do not exceed 140% of the rated voltage.



**Caution** The system shall only be used in an area of not more than Pollution Degree 2, as defined in IEC 60664-1.



**Caution** The system shall be mounted in an ATEX/IECEx-certified enclosure with a minimum ingress protection rating of at least IP54 as defined in IEC/EN 60079-15.



**Caution** The enclosure must have a door or cover accessible only by the use of a tool.

## Electromagnetic Compatibility Guidelines

This product was tested and complies with the regulatory requirements and limits for electromagnetic compatibility (EMC) stated in the product specifications. These requirements and limits provide reasonable protection against harmful interference when the product is operated in the intended operational electromagnetic environment.

This product is intended for use in industrial locations. However, harmful interference may occur in some installations, when the product is connected to a peripheral device or test object, or if the product is used in residential or commercial areas. To minimize interference with radio and television reception and prevent unacceptable performance degradation, install and use this product in strict accordance with the instructions in the product documentation.

Furthermore, any changes or modifications to the product not expressly approved by National Instruments could void your authority to operate it under your local regulatory rules.

## Special Conditions for Marine Applications

Some products are Lloyd's Register (LR) Type Approved for marine (shipboard) applications. To verify Lloyd's Register certification for a product, visit [ni.com/certification](https://ni.com/certification) and search for the LR certificate, or look for the Lloyd's Register mark on the product.



**Caution** In order to meet the EMC requirements for marine applications, install the product in a shielded enclosure with shielded and/or filtered power and input/output ports. In addition, take precautions when designing, selecting, and installing measurement probes and cables to ensure that the desired EMC performance is attained.

## What You Need to Install the NI 9157/9159

---

- NI 9157/9159 reconfigurable embedded chassis with integrated MXI-Express (x1)
- One of the following MXI-Express (x1) host systems:
  - PXI system with MXI-Express device installed
  - PC with MXI-Express PCI or PCIe device installed
  - NI Industrial Controller



### Note

The NI 9157/9159 requires a host system with a PCI Express clock that complies with the *PCI Express Specification*. The NI 9157/9159 may not be compatible with systems using noncompliant clocks, particularly clocks with peak frequencies higher than 100 MHz. For more information about PCI Express clock compatibility with the NI 9157/9159, go to [ni.com/info](https://ni.com/info) and enter the Info Code 915xclock.

- C Series I/O modules
- MXI-Express (x1) cable(s) up to 7 m long
- DIN rail mount kit (for DIN rail mounting only)
- Panel mount kit (for panel mounting only)
- Three M4 or number 8 panhead screws (for mounting the chassis without one of the listed mounting kits)
- Number 2 Phillips screwdriver

- Power supply
- *MXI-Express (x1) Series User Manual*



**Note** Visit [ni.com/info](https://ni.com/info) and enter the Info Code `rdsoftwareversion` to determine which software you need to use the NI 9157/9159.

## Mounting the NI 9157/9159

You can mount the chassis horizontally on a 35 mm DIN rail or on a flat, vertical, metallic surface such as a panel or wall. The maximum allowable ambient temperature for operation is 55 °C. Mounting the chassis in a different orientation or on a nonmetallic surface can reduce the maximum allowable ambient temperature and can affect the typical accuracy of modules in the chassis. The following figure shows the chassis mounted horizontally.

**Figure 2.** NI 9157/9159 Mounted Horizontally

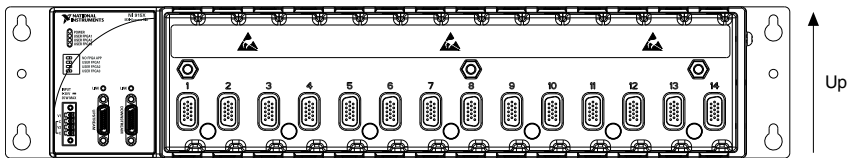

Measure the ambient temperature at each side of the chassis, 63.5 mm (2.5 in.) from the side and 50.8 mm (2 in.) forward from the rear of the chassis.



**Note** For more information about typical accuracy specification for modules, go to [ni.com/info](https://ni.com/info) and enter the Info Code `criotypical`.



**Caution** Your installation must meet the following requirements for space and cabling clearance:

- Allow 50.8 mm (2 in.) on the top and the bottom of the chassis for air circulation.
- Allow 50.8 mm (2 in.) in front of modules for cabling clearance for common connectors, such as the 10-terminal, detachable screw terminal connector.

**Figure 3. NI 9157/9159, Bottom View with Dimensions**

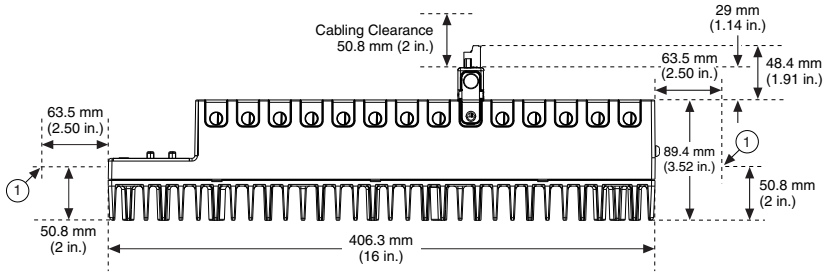

1. Measure ambient temperature here.

**Figure 4. NI 9157/9159, Front View with Dimensions**

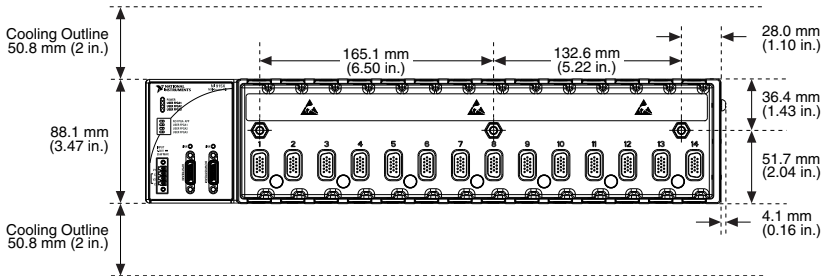

**Figure 5. NI 9157/9159, Side View with Dimensions**

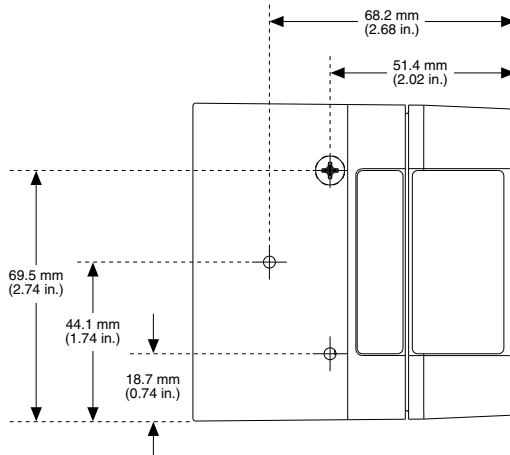

The following sections contain instructions for the mounting methods. Before using any of these mounting methods, record the serial number from the back of the chassis. You will be unable to read the serial number after you have mounted the chassis.



**Caution** Make sure that no I/O modules are in the chassis before mounting it.

## Mounting the Chassis on a DIN Rail

Use the DIN rail mounting method if you already have a DIN rail configuration or if you need to be able to remove the chassis quickly. You can order the NI 9916 DIN rail mount kit if you want to mount the chassis on a DIN rail. You need one clip for mounting the chassis on a standard 35 mm DIN rail. Complete the following steps to mount the chassis on a DIN rail.

1. Fasten the DIN rail clip to the chassis using a number 2 Phillips screwdriver and three M4 x 50 screws. NI provides these screws with the DIN rail mount kit. Tighten the screws to a maximum torque of 1.3 N · m (11.5 lb · in.).

**Figure 6.** Installing the DIN Rail Clip on the NI 9157/9159

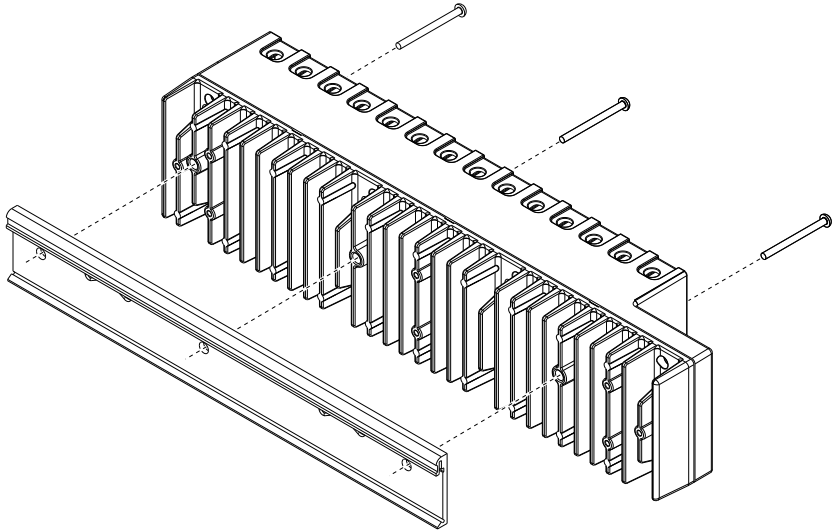

2. Insert one edge of the DIN rail into the deeper opening of the DIN rail clip.

**Figure 7.** One Edge of the DIN Rail Inserted in a Clip

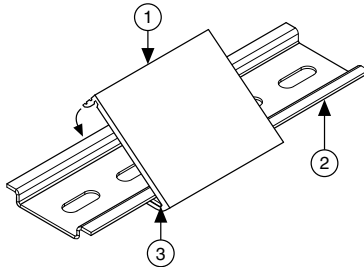

1. DIN Rail Clip
2. DIN Rail
3. DIN Rail Spring

3. Press down firmly on the chassis to compress the spring until the clip locks in place on the DIN rail.



**Caution** Make sure that no I/O modules are in the chassis before removing it from the DIN rail.



# Mounting the Chassis on a Flat Surface Using the NI 9907 Panel Mount Kit

Panel or wall mounting is the best method for applications that are subject to high shock and vibration. You can use the NI 9907 panel mount kit to mount the NI 9157/9159 on a flat surface. Complete the following steps.

1. Fasten the chassis to the panel mount kit using a number 2 Phillips screwdriver and six M4 x 50 screws. NI provides these screws with the panel mount kit. Tighten the screws to a maximum torque of 1.3 N · m (11.5 lb · in.).

**Figure 8.** Installing the Panel Mount Plate on the NI 9157/9159

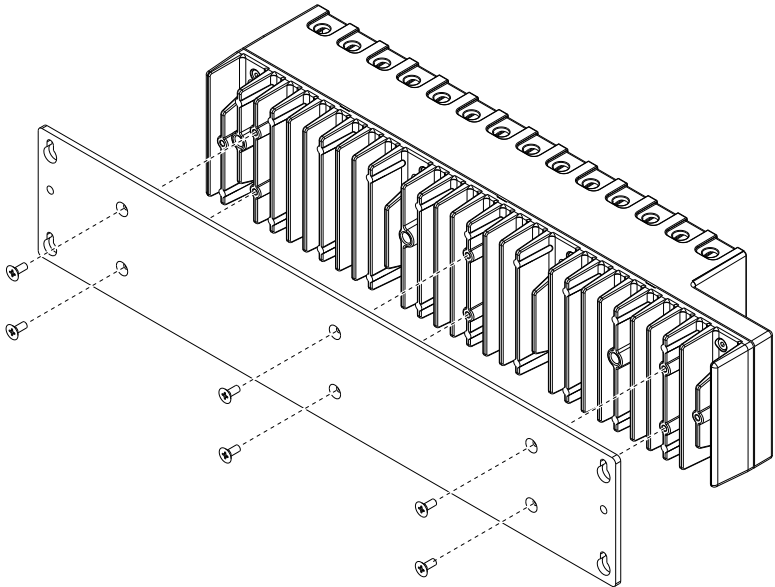

**Figure 9.** Dimensions of NI 9157/9159 with Panel Mounting Plate Installed

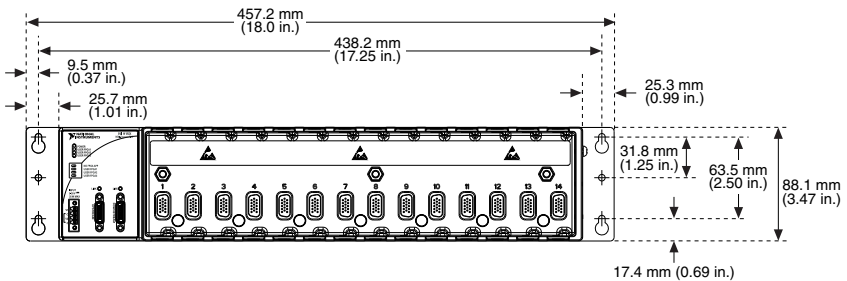

- Fasten the panel mounting plate to the surface using the screwdriver and screws that are appropriate for the surface. The maximum screw size is M4 or number 8.



**Caution** Make sure that no I/O modules are in the chassis before removing it from the panel.

## Mounting the Chassis Directly on a Flat Surface Using the Mounting Holes

Panel or wall mounting is the best method for high shock and vibration applications. If you do not have the NI 9907 panel mount kit and do not require the portability that the NI 9907 affords, you can mount the NI 9157/9159 directly on a flat surface using the three mounting holes. Complete the following steps.

- Align the chassis on the surface.
- Fasten the chassis to the surface using three M4 or number 8 screws. NI does not provide these screws with the chassis.

**Figure 10.** Mounting the NI 9157/9159 Directly on a Flat Surface

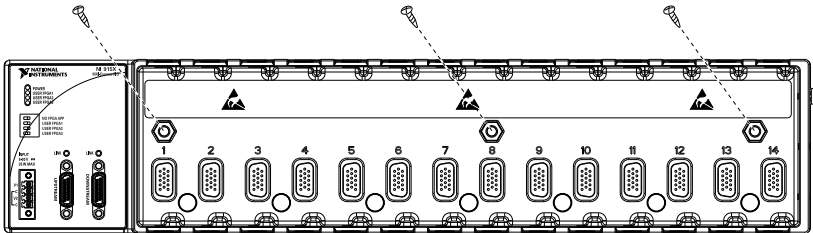

**Caution** Make sure that no I/O modules are in the chassis before removing it from the panel.

## Installing C Series Modules

The following figure shows the mechanical dimensions of C Series I/O modules.

**Figure 11.** C Series I/O Module, Front and Side View with Dimensions

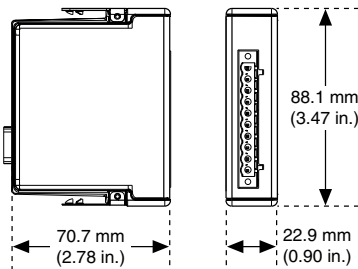

Complete the following steps to install a C Series I/O module in the chassis.

1. Make sure that no I/O-side power is connected to the I/O module. If the system is in a nonhazardous location, the chassis power can be on when you install I/O modules.
2. Align the I/O module with an I/O module slot in the chassis. The module slots are labeled 1 to 14, left to right.

**Figure 12.** Installing an I/O Module in the Chassis

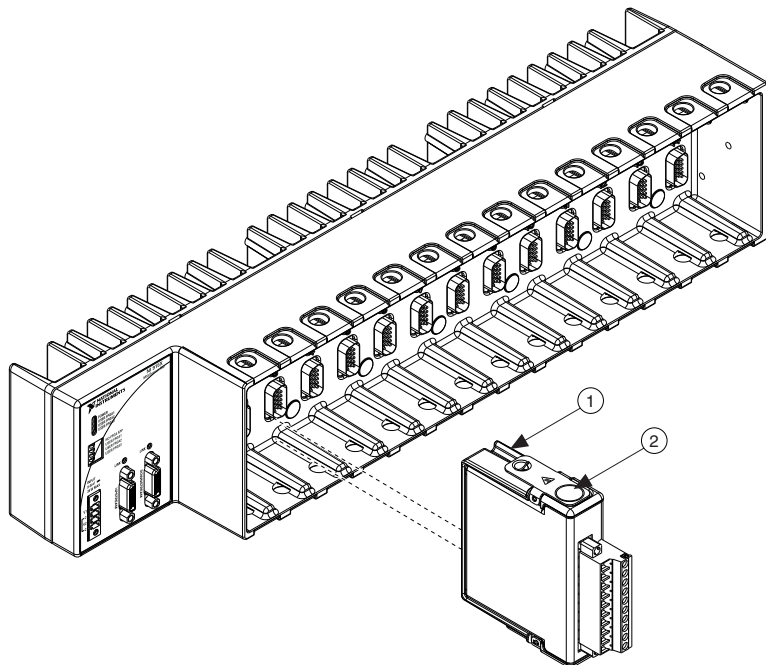

1. Insertion Groove
2. Latch

3. Squeeze the latches and insert the I/O module into the module slot.
4. Press firmly on the connector side of the I/O module until the latches lock the I/O module into place.
5. Repeat these steps to install additional I/O modules.

## Removing C Series Modules

Complete the following steps to remove a C Series I/O module from the chassis.

1. Make sure that no I/O-side power is connected to the I/O module. If the system is in a nonhazardous location, the chassis power can be on when you remove I/O modules.
2. Squeeze the latches on both sides of the module and pull the module out of the chassis.

# Wiring Power to the Chassis

---

The NI 9157/9159 requires an external power supply that meets the specifications. The NI 9157/9159 filters and regulates the supplied power and provides power for all of the I/O modules. You must connect a power supply to at least one pair of V and C terminals. Optionally, you can connect a second power supply to the other pair of V and C terminals. The chassis draws power from the power supply with the higher voltage. The NI 9157/9159 has one layer of reverse-voltage protection. Complete the following steps to connect a power supply to the chassis.

1. Connect the positive lead of the power supply to the V1 or V2 terminal of the COMBICON connector shipped with the NI 9157/9159.
2. Connect the negative lead of the power supply to one of the C terminals of the COMBICON connector.
3. Optionally you can connect the positive lead of another power supply to the other V terminal and the negative lead to one of the C terminals.
4. Install the COMBICON connector on the front panel of the NI 9157/9159.



**Note** The chassis draws power from either V1 or V2 depending on which terminal has a higher voltage. It does not draw power from both terminals. The chassis switches between V1 and V2 without affecting operation.



**Note** If you prefer for the chassis to draw power from one power supply, you must ensure that the voltage of that power supply, measured at the chassis power connector, is at least 500 mV higher than the voltage of the other power supply.



**Caution** The C terminals are internally connected to each other. If you use two power supplies, make sure that they share a common ground.



**Caution** The C terminals are internally connected to the body of the chassis to prevent a faulty ground connection from causing the chassis ground to float. If you reverse the input voltage, the positive input voltage is connected directly to the chassis. The chassis has built-in reversed-voltage protection, but reversed voltage can damage connected peripherals if the chassis ground is not reliably connected to earth ground.



**Caution** Do not tighten or loosen the terminal screws on the power connector while the power connector is plugged into the chassis or while the power supply is on.

## Connecting One or More NI 9157/9159 Chassis to the MXI-Express Host System or a Target

---

Complete the following steps to connect one or more NI 9157/9159 chassis to a MXI-Express host system or a target.

1. Make sure the MXI-Express host system is set up and configured as described in the *MXI-Express (x1) Series User Manual*.
2. If the MXI-Express host system is powered up, power it down.
3. If the NI 9157/9159 is powered up, power it down.
4. Use a MXI-Express (x1) cable to connect the MXI-Express host system to the Upstream port of the first NI 9157/9159 in the chain.
5. Use a MXI-Express (x1) cable to connect the Downstream port of the first NI 9157/9159 to the Upstream port of the next NI 9157/9159 in the chain.



**Note** The maximum number of NI 9157/9159 chassis in a chain depends on the system configuration. For example, a PXI system with an NI PXI-8196 controller can support four chassis per chain. Different types of systems may support more or fewer chassis per chain. For more information about how different system configurations can affect the maximum number of chassis in a chain, go to [ni.com/info](http://ni.com/info) and enter the Info Code 915xchain.

6. Power up all of the connected NI 9157/9159 chassis.
7. Power up the MXI-Express host system.



**Note** Refer to the *MXI-Express (x1) Series User Manual* for connectivity options and supported host devices.



**Caution** All connected NI 9157/9159 chassis must have power connected before the host system is powered up. The BIOS and OS of the host system must detect all bus segments on the chassis side in order to configure the PCI hierarchy. Powering connected chassis up or down while the host system is running can cause system hangs and data corruption.



**Caution** Do not remove MXI-Express (x1) cables while power is connected. Doing so can cause hangs or application errors. If a cable becomes unplugged, plug it back in and reboot.

## Chassis Powerup Options

The following table lists the reset options available for the NI 9157/9159. These options determine how the chassis behaves when it is powered on in various conditions. Use the RIO Device Setup utility to select reset options. Access the RIO Device Setup utility by selecting **Start»All Programs»National Instruments»NI-RIO»RIO Device Setup**.

**Table 1.** Chassis Powerup Options

Powerup Option	Behavior
Do Not Autoload VI	Does not load the FPGA bit stream from flash memory.
Autoload VI on device powerup	Loads the FPGA bit stream from flash memory to the FPGA when the chassis powers on.

If you want the NI 9157/9159 to autoload and run a VI at powerup, you must also configure the VI to autoload before you compile it. For more information about autoloading VIs, refer to the *LabVIEW FPGA Module Help*.

## Checking MXI-Express LINK LEDs for Status

After powering on the chassis and host system, check the MXI-Express LINK LEDs to ensure that all connected systems are linked and communicating properly. The MXI-Express LINK LEDs of the NI 9157/9159 indicate the following:

**Table 2.** NI 9157/9159 MXI-Express LINK LED Indications

LINK LED Appearance	Meaning
Off	Chassis power is off.
Solid yellow	Link is not established.
Solid green	Link is established.
Blinking yellow	PCI Express clock is incompatible with NI 9157/9159



**Note** For information about PCI Express clock compatibility with the NI 9157/9159, go to [ni.com/info](http://ni.com/info) and enter the Info Code 915xclock.

## Powering Down the MXI-Express System

Always power down the host system before powering down any connected NI 9157/9159 chassis. When the host system is powered down, the order in which the NI 9157/9159 chassis are powered down is not important.

## Configuring DIP Switches

**Figure 13.** DIP Switches

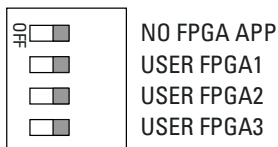

All of the DIP switches are in the OFF position when the chassis is shipped from National Instruments.

### NO FPGA APP Switch

Push the NO FPGA APP switch to the ON position to prevent a LabVIEW FPGA application from loading at startup. The NO FPGA APP switch overrides the chassis powerup options

described in the section on chassis powerup options. After startup you can download to the FPGA from software regardless of switch position.

## USER FPGA Switches

You can define the USER FPGA switches for your application. Use the LabVIEW FPGA Module and NI-RIO software to define the USER FPGA switches to meet the needs of your application. Refer to the *LabVIEW Help* for information about programming these switches.

## Understanding LED Indications

---

**Figure 14.** NI 9157/9159 LEDs

---

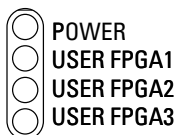

### POWER LED

The POWER LED is lit while the NI 9157/9159 is powered on. This LED is a bi-color LED. When the chassis is powered from V1, the POWER LED is lit green. When the chassis is powered from V2, the POWER LED is lit yellow.

### USER FPGA LEDs

You can use the bi-color, yellow and green USER FPGA LEDs to help debug your application or easily retrieve application status. Use the LabVIEW FPGA Module and NI-RIO software to define the USER FPGA LEDs to meet the needs of your application. Refer to *LabVIEW Help* for information about programming these LEDs.

## NI 9157/9159 Specifications

---

The following specifications are typical for the range 0 °C to 55 °C unless otherwise noted.



**Caution** Do not operate the NI 9157/9159 in a manner not specified in this document. Product misuse can result in a hazard. You can compromise the safety protection built into the product if the product is damaged in any way. If the product is damaged, return it to NI for repair.

### MXI-Express

Maximum cable length 7 m

---

# Reconfigurable FPGA

## NI 9157

FPGA type	Virtex-5 LX85
Number of flip-flops	51,840
Number of 6-input LUTs	51,840
Number of DSP48 slices (25 x 18 multipliers)	48
Embedded block RAM	3,456 kbits

## NI 9159

FPGA type	Virtex-5 LX110
Number of flip-flops	69,120
Number of 6-input LUTs	69,120
Number of DSP48 slices (25 x 18 multipliers)	64
Embedded block RAM	4,608 kbits

Timebases 40 MHz, 80 MHz, 120 MHz, 160 MHz, or 200 MHz

Accuracy  $\pm 100$  ppm (maximum)

Frequency dependent on jitter (peak-to-peak)

40 MHz	250 ps
80 MHz	422 ps
120 MHz	422 ps
160 MHz	402 ps
200 MHz	402 ps

## Power Requirements



**Caution** You must use the NI 9157/9159 with a 9 VDC to 30 VDC output, UL Listed limited power source (LPS) supply. The power supply must bear the UL Listed and LPS marks. The power supply must also meet any safety and compliance requirements for the country of use.

Recommended power supply	55 W, 30 VDC maximum
Voltage requirement	9 V to 30 V



## Chassis power consumption/dissipation

NI 9157	
With no I/O modules	14.4 W (maximum)
With 14 I/O modules	30.7 W (maximum)
NI 9159	
With no I/O modules	16.25 W (maximum)
With 14 I/O modules	32.7 W (maximum)



### Note

The power consumption specifications in this document are maximum values for a LabVIEW FPGA application compiled at 80 MHz. Your application power requirements may be different. To calculate the power requirements of the NI 9157/9159, add the power consumption/dissipation for the chassis and the I/O modules you are using. Keep in mind that the resulting total power consumption is a maximum value and that the NI 9157/9159 may require less power in your application. For more information about the I/O module power requirements, refer to the module operating instructions.

## Physical Characteristics

### Screw-terminal wiring

Gauge	0.2 mm <sup>2</sup> to 2.1 mm <sup>2</sup> (24 AWG to 14 AWG) copper conductor wire
Wire strip length	6 mm (0.24 in.) of insulation stripped from the end
Temperature rating	85 °C
Torque for screw terminals	0.20 N · m to 0.25 N · m (1.8 lb · in. to 2.2 lb · in.)
Wires per screw terminal	One wire per screw terminal

### Connector securement

Securement type	Screw flanges provided
Torque for screw flanges	0.3 N · m to 0.4 N · m (2.7 lb · in. to 3.5 lb · in.)

Weight	2,231 g (78.7 oz)
--------	-------------------

## Safety Voltages

Connect only voltages that are within the following limits:

V terminal to C terminal	30 VDC maximum, Measurement Category I
--------------------------	--

Measurement Category I is for measurements performed on circuits not directly connected to the electrical distribution system referred to as *MAINS* voltage. MAINS is a hazardous live electrical supply system that powers equipment. This category is for measurements of voltages from specially protected secondary circuits. Such voltage measurements include signal levels, special equipment, limited-energy parts of equipment, circuits powered by regulated low-voltage sources, and electronics.



**Caution** Do not connect the NI 9157/9159 to signals or use for measurements within Measurement Categories II, III, or IV.



**Note** Measurement Categories CAT I and CAT O are equivalent. These test and measurement circuits are not intended for direct connection to the MAINS building installations of Measurement Categories CAT II, CAT III, or CAT IV.

## Hazardous Locations

U.S. (UL)	Class I, Division 2, Groups A, B, C, D, T4; Class I, Zone 2, AEx nA IIC T4
Canada (C-UL)	Class I, Division 2, Groups A, B, C, D, T4; Class I, Zone 2, Ex nA IIC T4
Europe (ATEX) and International (IECEX)	Ex nA IIC T4 Gc

## Safety and Hazardous Locations Standards

This product is designed to meet the requirements of the following electrical equipment safety standards for measurement, control, and laboratory use:

- IEC 61010-1, EN 61010-1
- UL 61010-1, CSA 61010-1
- EN 60079-0:2012, EN 60079-15:2010
- IEC 60079-0: Ed 6, IEC 60079-15; Ed 4
- UL 60079-0; Ed 5, UL 60079-15; Ed 3
- CSA 60079-0:2011, CSA 60079-15:2012



**Note** For UL and other safety certifications, refer to the product label or the [Online Product Certification](#) section.

## Electromagnetic Compatibility

This product meets the requirements of the following EMC standards for electrical equipment for measurement, control, and laboratory use:

- EN 61326 (IEC 61326): Class A emissions; Industrial immunity
- EN 55011 (CISPR 11): Group 1, Class A emissions
- AS/NZS CISPR 11: Group 1, Class A emissions

- FCC 47 CFR Part 15B: Class A emissions
- ICES-001: Class A emissions



**Note** For EMC declarations and certifications, and additional information, refer to the [Online Product Certification](#) section.



**Note** For EMC compliance, operate this product according to the documentation.

## CE Compliance

This product meets the essential requirements of applicable European Directives, as follows:

- 2014/35/EU; Low-Voltage Directive (safety)
- 2014/30/EU; Electromagnetic Compatibility Directive (EMC)
- 94/9/EC; Potentially Explosive Atmospheres (ATEX)

## Online Product Certification

Refer to the product Declaration of Conformity (DoC) for additional regulatory compliance information. To obtain product certifications and the DoC for this product, visit [ni.com/certification](http://ni.com/certification), search by model number or product line, and click the appropriate link in the Certification column.

## Shock and Vibration

To meet these specifications, you must panel mount the system.

### Operating vibration

Random (IEC 60068-2-64)	5 g <sub>rms</sub> , 10 Hz to 500 Hz
Sinusoidal (IEC 60068-2-6)	5 g, 10 Hz to 500 Hz
Operating shock (IEC 60068-2-27)	30 g, 11 ms half sine; 50 g, 3 ms half sine; 18 shocks at 6 orientations

## Environmental

Refer to the manual for the chassis you are using for more information about meeting these specifications.



**Note** Refer to the mounting instructions in the [Mounting the NI 9157/9159](#) section of this document. Failure to follow the mounting instructions in that section can cause temperature derating. For more information about mounting configurations

and temperature derating, go to [ni.com/info](http://ni.com/info) and enter the Info Code criomounting.

Operating temperature (IEC 60068-2-1, IEC 60068-2-2)	0 °C to 55 °C
Storage temperature (IEC 60068-2-1, IEC 60068-2-2)	-40 °C to 85 °C
Ingress protection	IP40
Operating humidity (IEC 60068-2-78)	10% RH to 90% RH, noncondensing
Storage humidity (IEC 60068-2-78)	5% RH to 95% RH, noncondensing
Pollution Degree	2
Maximum altitude	2,000 m

Indoor use only.

## Environmental Management

NI is committed to designing and manufacturing products in an environmentally responsible manner. NI recognizes that eliminating certain hazardous substances from our products is beneficial to the environment and to NI customers.

For additional environmental information, refer to the *Minimize Our Environmental Impact* web page at [ni.com/environment](http://ni.com/environment). This page contains the environmental regulations and directives with which NI complies, as well as other environmental information not included in this document.

## Waste Electrical and Electronic Equipment (WEEE)



**EU Customers** At the end of the product life cycle, all NI products must be disposed of according to local laws and regulations. For more information about how to recycle NI products in your region, visit [ni.com/environment/weee](http://ni.com/environment/weee).

## 电子信息产品污染控制管理办法（中国 RoHS）



**中国客户** National Instruments 符合中国电子信息产品中限制使用某些有害物质指令 (RoHS)。关于 National Instruments 中国 RoHS 合规性信息，请登录 [ni.com/environment/rohs\\_china](http://ni.com/environment/rohs_china)。(For information about China RoHS compliance, go to [ni.com/environment/rohs\\_china](http://ni.com/environment/rohs_china).)

## Worldwide Support and Services

The NI website is your complete resource for technical support. At [ni.com/support](http://ni.com/support), you have access to everything from troubleshooting and application development self-help resources to email and phone assistance from NI Application Engineers.

Visit [ni.com/services](https://ni.com/services) for NI Factory Installation Services, repairs, extended warranty, and other services.

Visit [ni.com/register](https://ni.com/register) to register your NI product. Product registration facilitates technical support and ensures that you receive important information updates from NI.

A Declaration of Conformity (DoC) is our claim of compliance with the Council of the European Communities using the manufacturer's declaration of conformity. This system affords the user protection for electromagnetic compatibility (EMC) and product safety. You can obtain the DoC for your product by visiting [ni.com/certification](https://ni.com/certification). If your product supports calibration, you can obtain the calibration certificate for your product at [ni.com/calibration](https://ni.com/calibration).

NI corporate headquarters is located at 11500 North Mopac Expressway, Austin, Texas, 78759-3504. NI also has offices located around the world. For telephone support in the United States, create your service request at [ni.com/support](https://ni.com/support) or dial 1 866 ASK MYNI (275 6964). For telephone support outside the United States, visit the *Worldwide Offices* section of [ni.com/niglobal](https://ni.com/niglobal) to access the branch office websites, which provide up-to-date contact information, support phone numbers, email addresses, and current events.

Refer to the *NI Trademarks and Logo Guidelines* at [ni.com/trademarks](https://ni.com/trademarks) for information on NI trademarks. Other product and company names mentioned herein are trademarks or trade names of their respective companies. For patents covering NI products/technology, refer to the appropriate location: **Help»Patents** in your software, the `patents.txt` file on your media, or the *National Instruments Patent Notice* at [ni.com/patents](https://ni.com/patents). You can find information about end-user license agreements (EULAs) and third-party legal notices in the readme file for your NI product. Refer to the *Export Compliance Information* at [ni.com/legal/export-compliance](https://ni.com/legal/export-compliance) for the NI global trade compliance policy and how to obtain relevant HTS codes, ECCNs, and other import/export data. NI MAKES NO EXPRESS OR IMPLIED WARRANTIES AS TO THE ACCURACY OF THE INFORMATION CONTAINED HEREIN AND SHALL NOT BE LIABLE FOR ANY ERRORS. U.S. Government Customers: The data contained in this manual was developed at private expense and is subject to the applicable limited rights and restricted data rights as set forth in FAR 52.227-14, DFAR 252.227-7014, and DFAR 252.227-7015.

© 2010—2016 National Instruments. All rights reserved.

375184E-01 Apr16