

COMPREHENSIVE SERVICES

We offer competitive repair and calibration services, as well as easily accessible documentation and free downloadable resources.

SELL YOUR SURPLUS

We buy new, used, decommissioned, and surplus parts from every NI series. We work out the best solution to suit your individual needs.

 Sell For Cash  Get Credit  Receive a Trade-In Deal

OBSOLETE NI HARDWARE IN STOCK & READY TO SHIP

We stock **New**, **New Surplus**, **Refurbished**, and **Reconditioned** NI Hardware.



Bridging the gap between the manufacturer and your legacy test system.

 1-800-915-6216

 www.apexwaves.com

 sales@apexwaves.com

All trademarks, brands, and brand names are the property of their respective owners.

Request a Quote

 **CLICK HERE**

PXI-8421-4

Serial Quick Reference Guide

10-Position Modular Jack

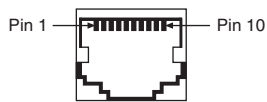

Pin	232	422/485
1	No Connect	No Connect
2	RI ¹	TXD-
3	CTS	TXD+
4	RTS	RTS- (HSO-)
5	DSR ¹	CTS- (HSI-)
6	GND	RXD-
7	DTR ¹	RXD+
8	TXD	RTS+ (HSO+)
9	RXD	CTS+ (HSI+)
10	DCD ¹	GND

¹ These signals are "No Connect" on the PCI-2321 and PXI-8422 ports.

DB-9 Male



Pin	232 DTE	232 DCE	422/485
1	DCD ²	DCD	GND
2	RXD	TXD	CTS+ (HSI+)
3	TXD	RXD	RTS+ (HSO+)
4	DTR ²	DSR	RXD+
5	GND	GND	RXD-
6	DSR ²	DTR	CTS- (HSI-)
7	RTS	CTS	RTS- (HSO-)
8	CTS	RTS	TXD+
9	RI ²	RI	TXD-

Note: DCE mode supported on USB-232/2 and USB-232/4 only.

² These signals are "No Connect" on the PCI-2321 and PXI-8422 ports and ports 9-16 on legacy 16-port boards.

DB-25 Male

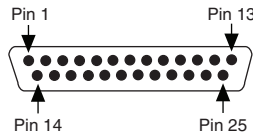

Pin	232	422/485
2	TXD	RTS+ (HSO+)
3	RXD	CTS+ (HSI+)
4	RTS	RTS- (HSO-)
5	CTS	TXD+
6	DSR ³	CTS- (HSI-)
7	GND	RXD-
8	DCD ³	GND
20	DTR ³	RXD+
22	RI ³	TXD-

Pins not listed in this table are "No Connect."

³ These signals are "No Connect" on the PCI-2321 and PXI-8422 ports.

RS-232 Loopback

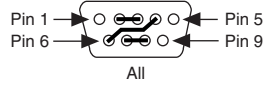
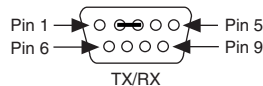

RS-485/422 Loopback

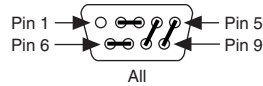
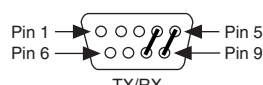

RS-232 Signals

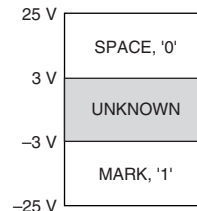

RS-485/422 Signals

If '-' < '+'
then MARK, '1'

If '-' > '+'
then SPACE, '0'

RS-422 Voltage: ±7 V

RS-485 Voltage:
-7 V to +12 V

UART Data Frame Example

0xD9—8 Data Bits, Odd Parity, 1 Stop Bit

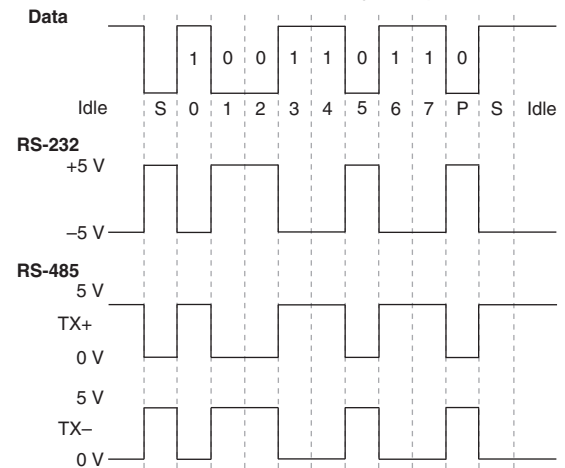

Voltagess are for illustration only. Actual voltage levels may vary.

RS-485 Topologies

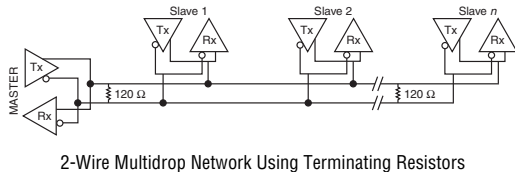

2-Wire Multidrop Network Using Terminating Resistors

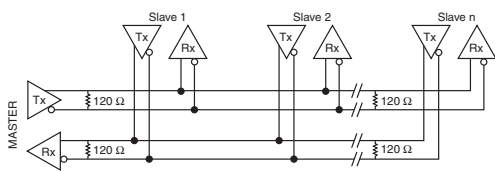

4-Wire Full-Duplex Multidrop Network Using Terminating Resistors

The driver directly supports 4-wire full-duplex operation on peer-to-peer RS-485 networks. Multidrop RS-485 networks require additional software development.

LabVIEW Programming Example

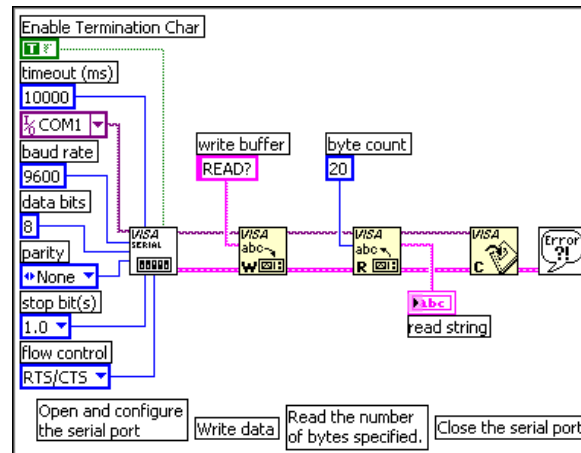

For more information about LabVIEW, refer to ni.com/labview.

ASCII Table

Dec	Hex	Char	Dec	Hex	Char	Dec	Hex	Char	Dec	Hex	Char
0	0x00	(nul)	32	0x20	(sp)	64	0x40	@	96	0x60	'
1	0x01	(soh)	33	0x21	!	65	0x41	A	97	0x61	a
2	0x02	(stx)	34	0x22	"	66	0x42	B	98	0x62	b
3	0x03	(etx)	35	0x23	#	67	0x43	C	99	0x63	c
4	0x04	(eot)	36	0x24	\$	68	0x44	D	100	0x64	d
5	0x05	(enq)	37	0x25	%	69	0x45	E	101	0x65	e
6	0x06	(ack)	38	0x26	&	70	0x46	F	102	0x66	f
7	0x07	(bel)	39	0x27	'	71	0x47	G	103	0x67	g
8	0x08	(bs)	40	0x28	(72	0x48	H	104	0x68	h
9	0x09	(tab)	41	0x29)	73	0x49	I	105	0x69	i
10	0x0A	(lf)	42	0x2A	*	74	0x4A	J	106	0x6A	j
11	0x0B	(vt)	43	0x2B	+	75	0x4B	K	107	0x6B	k
12	0x0C	(ff)	44	0x2C	,	76	0x4C	L	108	0x6C	l
13	0x0D	(cr)	45	0x2D	-	77	0x4D	M	109	0x6D	m
14	0x0E	(so)	46	0x2E	.	78	0x4E	N	110	0x6E	n
15	0x0F	(si)	47	0x2F	/	79	0x4F	O	111	0x6F	o
16	0x10	(dle)	48	0x30	0	80	0x50	P	112	0x70	p
17	0x11	(dc1)	49	0x31	1	81	0x51	Q	113	0x71	q
18	0x12	(dc2)	50	0x32	2	82	0x52	R	114	0x72	r
19	0x13	(dc3)	51	0x33	3	83	0x53	S	115	0x73	s
20	0x14	(dc4)	52	0x34	4	84	0x54	T	116	0x74	t
21	0x15	(nak)	53	0x35	5	85	0x55	U	117	0x75	u
22	0x16	(syn)	54	0x36	6	86	0x56	V	118	0x76	v
23	0x17	(etb)	55	0x37	7	87	0x57	W	119	0x77	w
24	0x18	(can)	56	0x38	8	88	0x58	X	120	0x78	x
25	0x19	(em)	57	0x39	9	89	0x59	Y	121	0x79	y
26	0x1A	(sub)	58	0x3A	:	90	0x5A	Z	122	0x7A	z
27	0x1B	(esc)	59	0x3B	;	91	0x5B	[123	0x7B	{
28	0x1C	(fs)	60	0x3C	<	92	0x5C	\	124	0x7C	
29	0x1D	(gs)	61	0x3D	=	93	0x5D]	125	0x7D	}
30	0x1E	(rs)	62	0x3E	>	94	0x5E	^	126	0x7E	~
31	0x1F	(us)	63	0x3F	?	95	0x5F	_	127	0x7F	(del)

RS-485 Transceiver Control

Enable	4-Wire	2-Wire		
		DTR/Echo	DTR/No Echo	Auto
TX	ON	DTR	DTR	TX
RX	ON	ON	DTR	TX

NI-Serial Features

Hardware

- Flexible baud rates up to 3 Mb/s
- High-performance DMA engine
- Isolation up to 2000 V
- RS-485 transceiver control

Software

- Deterministic control with LabVIEW Real-Time
- Over 3000 instrument drivers online
- Powerful development tools

For more information about NI Serial products, refer to ni.com/serial.

For more information about NI products, refer to ni.com.

Refer to the *NI Trademarks and Logo Guidelines* at ni.com/trademarks for more information on National Instruments trademarks. Other product and company names mentioned herein are trademarks or trade names of their respective companies. For patents covering National Instruments products/technology, refer to the appropriate location: **Help»Patents** in your software, the `patents.txt` file on your media, or the *National Instruments Patents Notice* at ni.com/patents. You can find information about end-user license agreements (EULAs) and third-party legal notices in the readme file for your NI product. Refer to the *Export Compliance Information* at ni.com/legal/export-compliance for the National Instruments global trade compliance policy and how to obtain relevant HTS codes, ECCNs, and other import/export data.