

COMPREHENSIVE SERVICES

We offer competitive repair and calibration services, as well as easily accessible documentation and free downloadable resources.

SELL YOUR SURPLUS

We buy new, used, decommissioned, and surplus parts from every NI series. We work out the best solution to suit your individual needs.

 Sell For Cash  Get Credit  Receive a Trade-In Deal

OBSOLETE NI HARDWARE IN STOCK & READY TO SHIP

We stock **New**, **New Surplus**, **Refurbished**, and **Reconditioned** NI Hardware.



Bridging the gap between the manufacturer and your legacy test system.

 1-800-915-6216

 www.apexwaves.com

 sales@apexwaves.com

All trademarks, brands, and brand names are the property of their respective owners.

Request a Quote

 **CLICK HERE**

PXIe-1075

INSTALLATION GUIDE

Chassis Fan Intake/Exhaust Air Diverter

This guide describes how to mount an air diverter to an 18-slot PXI or PXI Express chassis. This accessory can be used to divert chassis exhaust air to the rear or front of a rack, or bring air to the chassis air inlet from the front or rear of the chassis. These accessories are designed to work with a universal 19 in. (482.6 mm) rack opening (EIA-310-D) and occupy one rack unit 1.75 in. (44.45 mm) above and/or below a chassis.

There are two types of air diverters. An extended version, NI Part Number (782508-01), is for intake or exhaust from the rear of the rack. A smaller version, NI Part Number (782508-02), is for intake or exhaust from the front of the rack.

There are many configurations possible to meet your specific application. Table 1 indicates supported configurations, contact NI sales with any questions regarding your specific application.

Table 1. Supported Air Diverter Configurations

Chassis Configuration	Chassis Exhaust Position		Chassis Intake Position	
	Front	Rear	Front	Rear
NI PXIe-1066DC	✓	✓	✓	✓
4U 18-Slot Chassis*	✓	—		

* Intake is fixed at rear of chassis

Figure 1 shows the rear-facing extended air diverter.

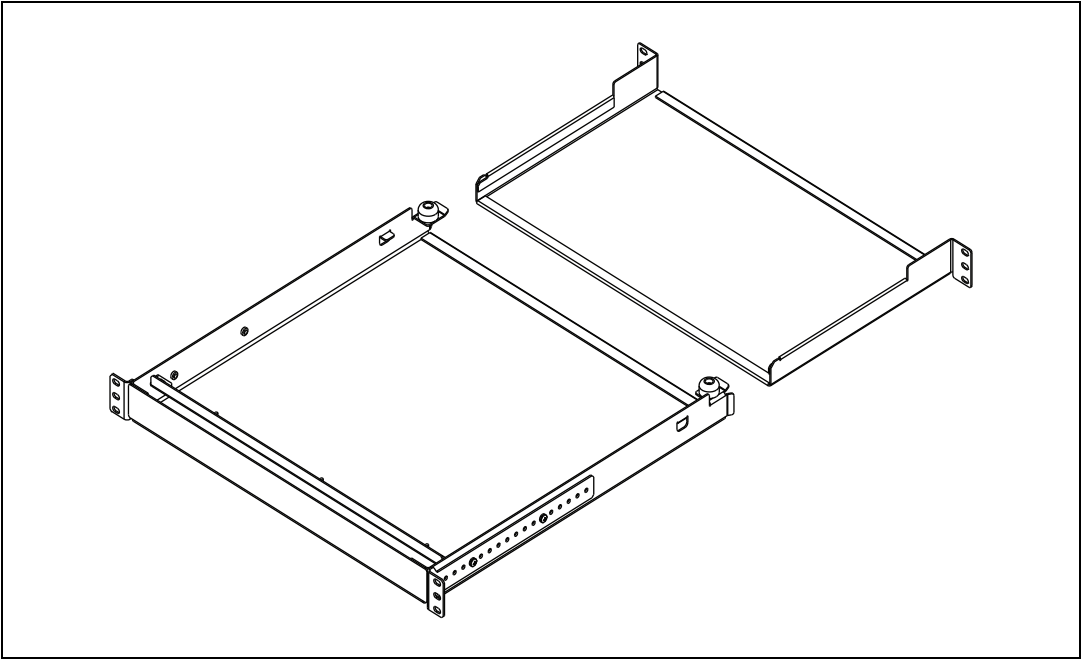

Figure 1. Extended Chassis Intake/Exhaust Air Diverter (Part Number 782508-01)

Figure 2 shows the forward-facing air diverter.

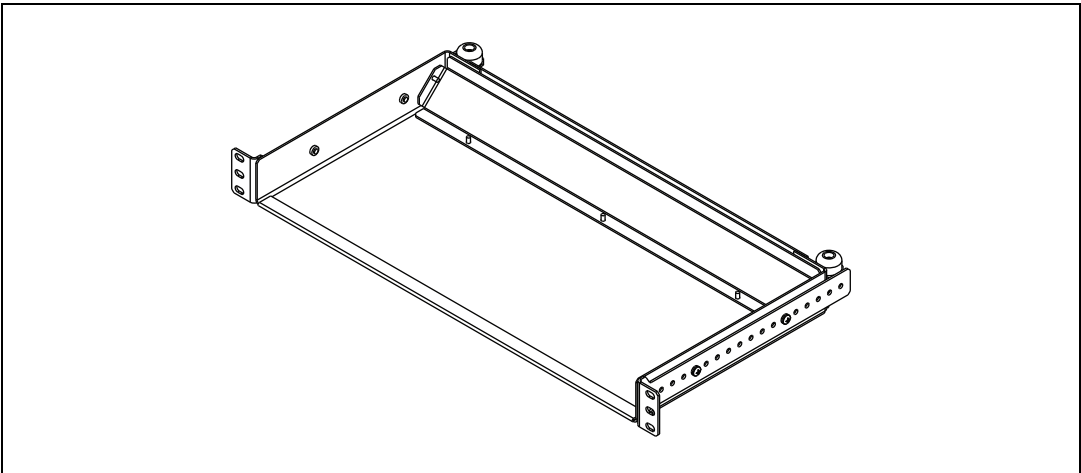

Figure 2. Chassis Intake/Exhaust Air Diverter Extension (Part Number 782508-02)

Complete the following steps to mount side brackets to an air diverter:

1. Tighten the supplied screws to 11.5 in · lb. (1.3 n · m) recommended torque.
2. Adjust the depth of the diverter as required.

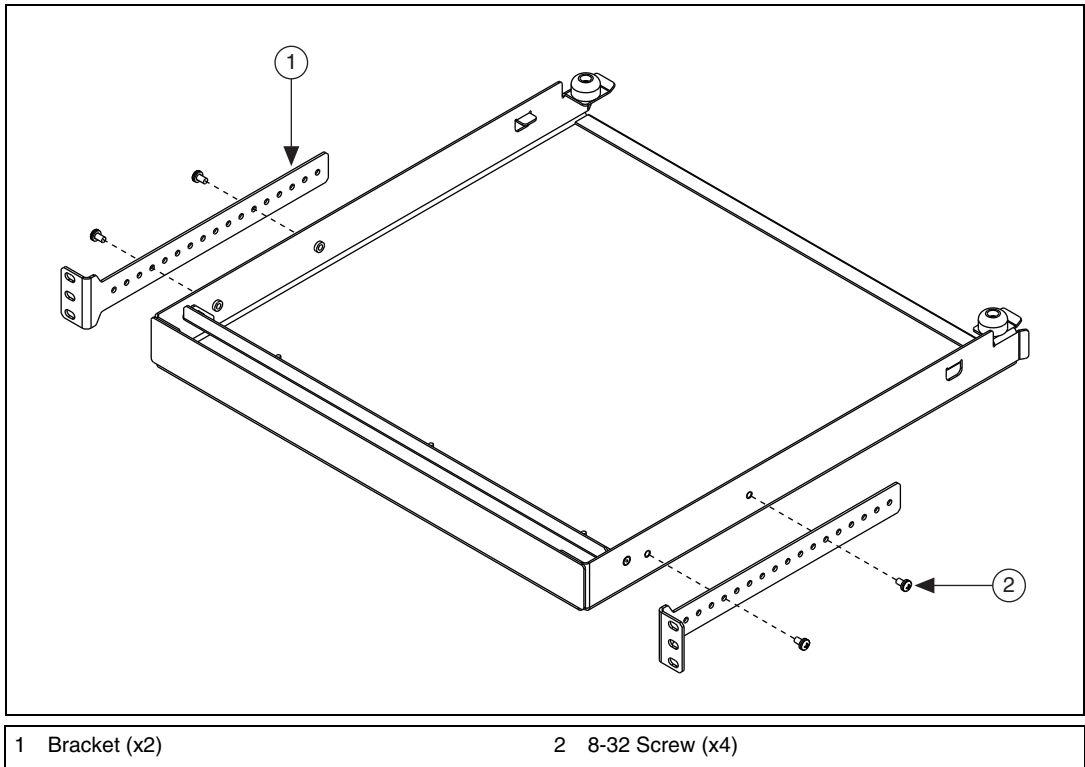

Figure 3. Installing Side Brackets to an Air Diverter

To attach the extended air diverter complete the following steps:

1. Slide the rear air diverter baffle into the extended air diverter.
2. Adjust for rack depths of 20-24 in.

The following figure shows how to connect the extended air diverter.

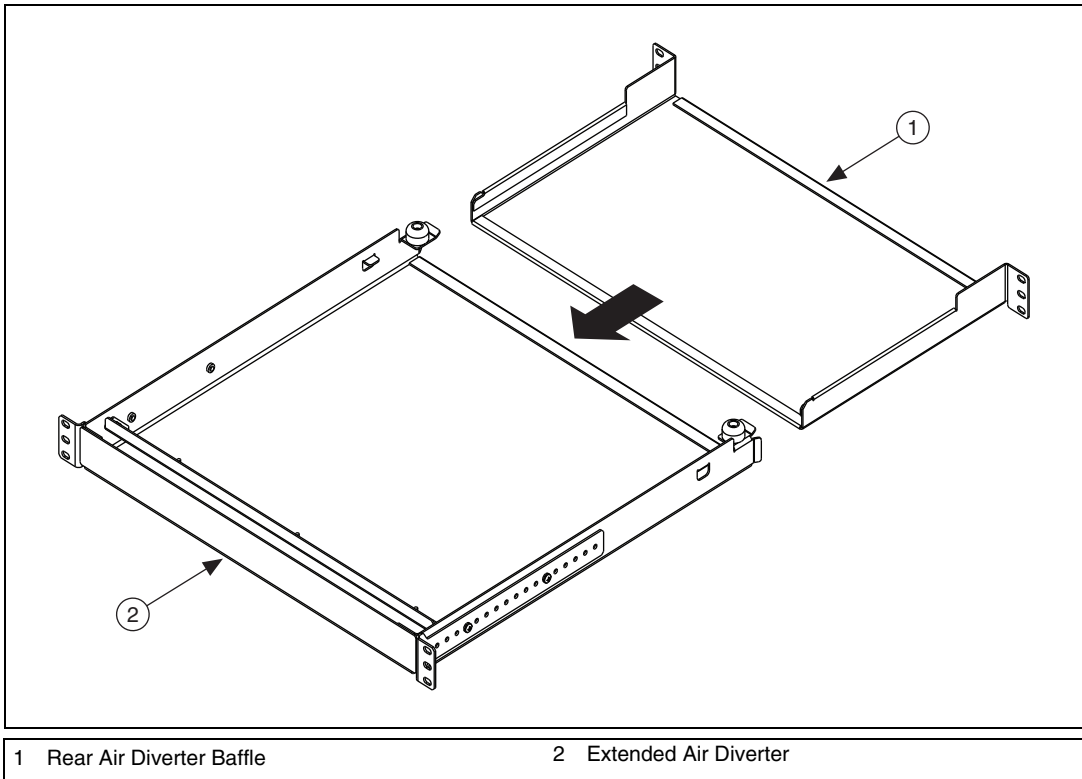

Figure 4. Attaching the Extended Chassis Intake/Exhaust Air Diverter

The following figure depicts an example configuration using a NI PXIe-1066DC chassis with air intake front/bottom and air exhaust top/rear.

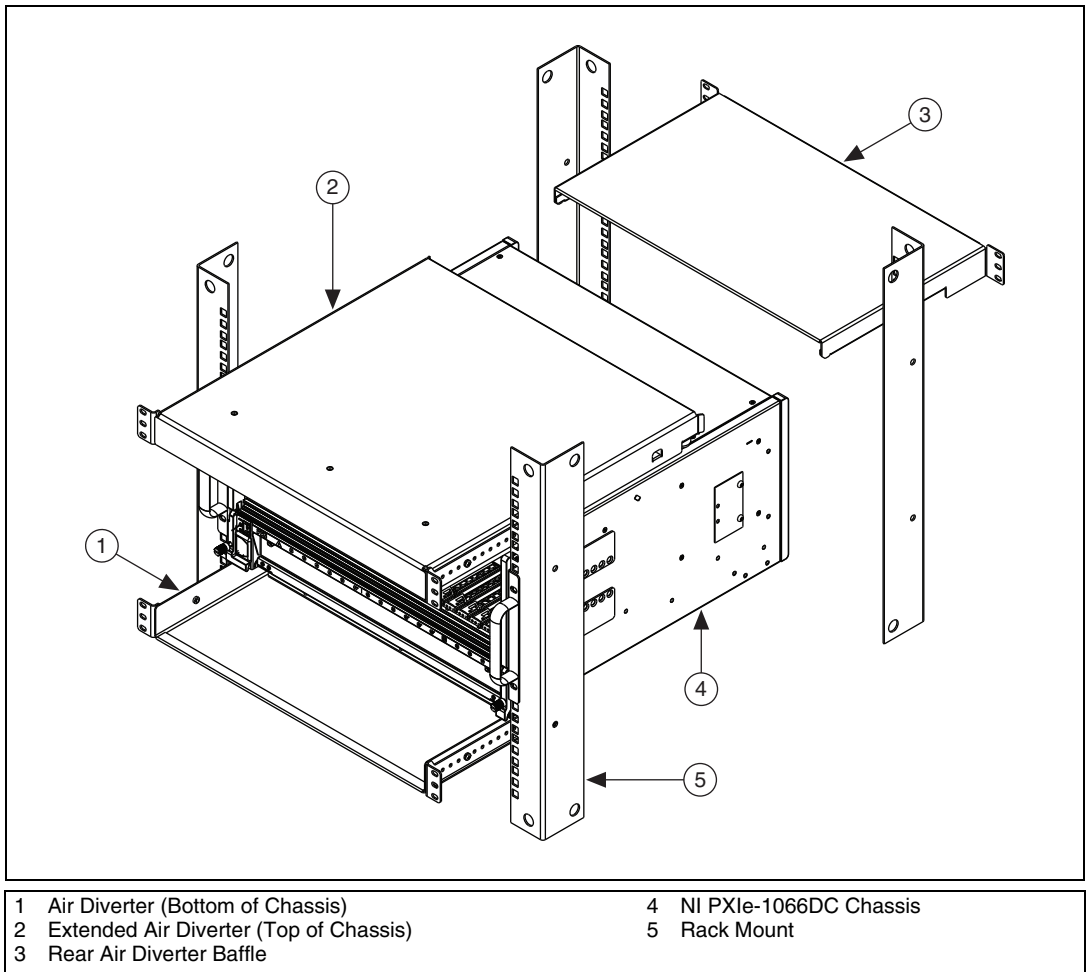

Figure 5. Exploded View of an Example Configuration

Complete the following steps to mount the air diverter (refer to the previous figures for parts and locations):

1. If present, remove the bottom feet, side feet, and COA label plate (as required) from the chassis.
2. Remove the side handle.
3. Position air diverter directly above and/or below chassis.
4. Attach the air diverters and baffle to the rack mount with appropriate screws (not included) for the rack.



Note The bracket allows for #10-32, #12-24, M5, and M6 screws.

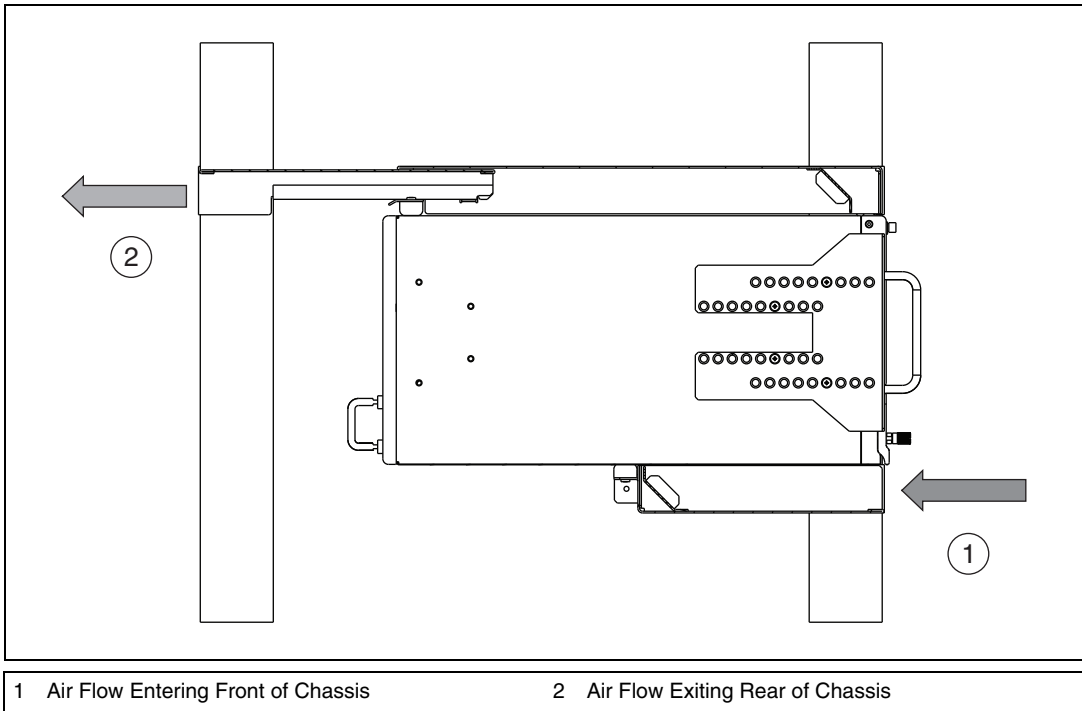

Figure 6. Example Configuration Showing Air Flow Through Chassis
(One Potential Configuration Shown)

LabVIEW, National Instruments, NI, ni.com, the National Instruments corporate logo, and the Eagle logo are trademarks of National Instruments Corporation. Refer to the *Trademark Information* at ni.com/trademarks for other National Instruments trademarks. Other product and company names mentioned herein are trademarks or trade names of their respective companies. For patents covering National Instruments products/technology, refer to the appropriate location: **Help»Patents** in your software, the `patents.txt` file on your media, or the *National Instruments Patent Notice* at ni.com/patents. Refer to the *Export Compliance Information* at ni.com/legal/export-compliance for the National Instruments global trade compliance policy and how to obtain relevant HTS codes, ECCNs, and other import/export data.