

COMPREHENSIVE SERVICES

We offer competitive repair and calibration services, as well as easily accessible documentation and free downloadable resources.

SELL YOUR SURPLUS

We buy new, used, decommissioned, and surplus parts from every NI series. We work out the best solution to suit your individual needs.

 Sell For Cash  Get Credit  Receive a Trade-In Deal

OBSOLETE NI HARDWARE IN STOCK & READY TO SHIP

We stock **New**, **New Surplus**, **Refurbished**, and **Reconditioned** NI Hardware.



Bridging the gap between the manufacturer and your legacy test system.

 1-800-915-6216

 www.apexwaves.com

 sales@apexwaves.com

All trademarks, brands, and brand names are the property of their respective owners.

Request a Quote

 **CLICK HERE**

PXIe-1085

GETTING STARTED GUIDE

MIMO Prototyping System

This document explains how to use the MIMO Application Framework with a modular hardware system consisting of multiple universal software radio peripheral (USRP) devices in a multiple input, multiple output (MIMO) configuration.

Contents

System Requirements	2
Hardware Requirements	2
Hardware Setup	4
Electromagnetic Compatibility Guidelines.....	4
General system components	4
Single Antenna Mobile Station	4
Multi-Antenna Mobile Station	5
Base Station.....	5
Detailed Hardware Setup.....	7
Rack Assembly Diagrams.....	8
Installing PXIe Modules	12
Cable Connections.....	12
Connection Diagrams	15
Installing the Software	18
Online Installation	18
Offline Installation	18
Powering on the Hardware.....	19
Base Station and Multi-Antenna Mobile Station.....	19
Single Antenna Mobile Station	19
Software	19
Hardware Naming	19
Understanding the Components of this Sample Project	20
Create a New Design Project Instance	20
Folder Structure	20
Deploy 23	
Create a New Simulation Project Instance.....	23

Folder Structure.....	23
System Overview	24
System Features	24
System Components.....	24
Running the LabVIEW Host Code.....	29
On the BS Host Computer	29
On the Single Antenna MS Host Computer	30
On the Multi-Antenna MS Host Computer.....	32
System Running Verification	33
Running Video Streaming	34
Start Video Stream at the Transmitter (MS)	34
Start Video Stream at the Receiver (BS).....	36
Description of Controls and Indicators	37
Description of Controls and Indicators on the BS Host Front Panel.....	37
Description of Controls and Indicators on the Single Antenna MS Host Front Panel	51
Description of Controls and Indicators on the Multi-Antenna MS Host Front Panel	60
Troubleshooting.....	69
Related Information.....	69

System Requirements

Refer to the product readme, which is installed and available online at ni.com/manuals, for more information about minimum system requirements, recommended system, and supported application development environments (ADEs).

Hardware Requirements

Depending on the system configuration, the main system hardware components are listed in the following tables.

Table 1. MIMO Base Station (BS) and Multi-Antenna Mobile Station (MS) Parts List¹

¹ This is not a complete list of required hardware. For a complete list, contact your local sales representative.

Description	Quantity Needed for Each Configuration				
	128-antenna BS 8 subsystems	64-antenna BS 4 subsystems	32-antenna BS 2 subsystems	16-antenna BS 1 subsystem	12-antenna MS 1 subsystem
USRP-2940/2942/ 2943/2944/2950/ 2952/2953/2954 Software Defined Radio Reconfigurable Device	64	32	16	8	6
x4 MXI-Express Cable	64	32	16	8	6
PXle-1085 Chassis (18-Slot, 24 GB/s System Bandwidth (BW))	1	1	1	1	1
PXle-8135 Controller	1	1	1	1	1
PXle-7976 FPGA Module for FlexRIO	5	3	2	2	2
PXle-6674T Synchronization Module	1	1	1	1	1
2.4 GHz and 5 GHz Dual Band Vertical Antenna	128	64	32	16	12
CDA-2990 Clock Distribution Device ²	8	5	3	1	1
8 GB RAM Upgrade for PXle-8135	1	1	1	1	1
PXle-8384 Bus Extension Module (x8 Gen2 MXI-Express)	2	4	2	1	1
x8 MXI-Express Cable	8	4	2	1	1
USRP SMA-to-SMA Cable (ships with each USRP device)	128	64	32	16	12
Additional SMA-to- SMA Cable	19	11	7	3	3
CPS-8910 Switch Device for PCI Express ³	8	4	2	1	1

Table 2. Single Antenna MS Part List⁴

Description	Per MS
-------------	--------

² Also referred to as a Clock Distribution Accessory (CDA).

³ Also referred to as a Cabled PXI Express Switch Box (CPS).

⁴ This is not a complete list of required hardware. For a complete list please contact your local sales representative.

USRP-2950/2952/2953/2954/2974	1
USRP RIO Laptop Connectivity Kit (ExpressCard and Cable)	1
Laptop with ExpressCard Slot	1
2.4 GHz and 5 GHz Dual Band Vertical Antenna	2

Hardware Setup

Electromagnetic Compatibility Guidelines

The individual components of this product were tested and comply with the regulatory requirements and limits for electromagnetic compatibility (EMC) stated in their respective specifications. These requirements and limits provide reasonable protection against harmful interference when the product is operated in the intended operational electromagnetic environment. However, the system as a whole has not been through EMC testing as a unit and the users are expected to use it in a way that complies to all regulations in their region.

To minimize interference with radio and television reception and prevent unacceptable performance degradation, install and use this product in strict accordance with the instructions in the product documentation.

Furthermore, any changes or modifications to the product not expressly approved by National Instruments could void your authority to operate it under your local regulatory rules.

Note: In the United States (per FCC 47 CFR), Class A equipment is intended for use in commercial, light-industrial, and heavy-industrial locations. In Europe, Canada, Australia, and New Zealand (per CISPR 11), Class A equipment is intended for use only in heavy-industrial locations.

Notice: The MIMO System is intended for use only indoors test environment as test and measurement equipment. This product is intended for professional use only.

Notice: To ensure the specified EMC performance, operate this product only with shielded cables and accessories.

Notice: To ensure the specified EMC performance, operate this product only with cables less than 3 meters in length.

General system components

The MIMO Application Framework supports system setups consisting of the following components:

- One multi-antenna BS
- One or more MSs

Both single antenna and multi-antenna MSs are supported.

Single Antenna Mobile Station

The least complex system component supported by the MIMO Application Framework is the single antenna MS. A single antenna MS represents a handset or another wireless device with single input,

single output (SISO) wireless capabilities. The MIMO Application Framework supports up to 12 simultaneous single antenna MSs. The single antenna MS prototype uses a USRP device with an integrated GPS disciplined oscillator (GPSDO)⁵, which is connected through a PCI Express cable to a laptop (typical setup), a PC, or a PXI controller operating within a PXI chassis using the specific PCI Express connectivity kits. Typical testbed implementation includes multiple MSs where each USRP device represents up to two single antenna MS devices. Single antenna MSs use a different implementation software than the multi-antenna MSs. The physical layer (PHY) functionality is mainly implemented on the FPGA of the USRP device while the basic media access control (MAC) layer functionality (data piping) is split between FPGA and host.

Figure 1. Typical Single Antenna MS Setup with Laptop and USRP Device

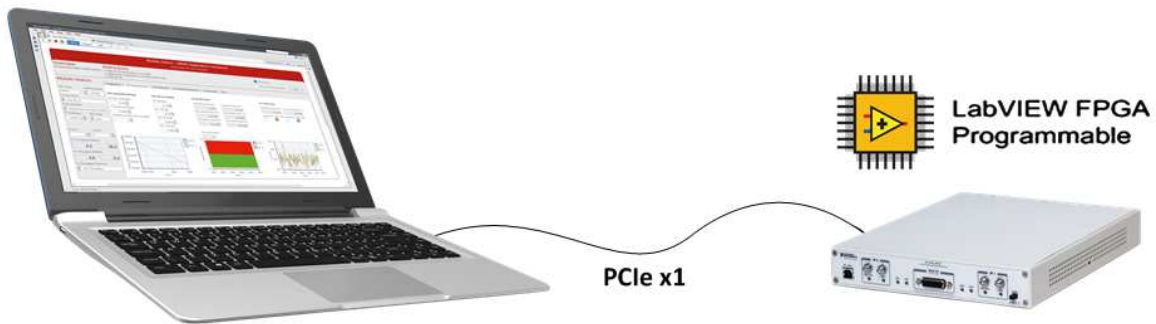

Table 2 provides a quick reference of hardware parts used for the typical laptop-based setup of a single antenna MS system.

Multi-Antenna Mobile Station

The MIMO Application Framework supports single-user MIMO use cases. For this, multi-antenna MSs with an even number of antennas between two and 12 are supported. A multi-antenna MS uses the same general hardware setup as a 16-antenna BS. The number of USRP devices (used as remote radio heads (RRHs)), can be lower and depends on the number of antennas. Two antennas are supported for each USRP device.

Base Station

The multi-antenna BS and the multi-antenna MS are the most complex system components supported by the MIMO Application Framework. The complexity increases with the number of antennas. While the number of antennas for the multi-antenna MS is limited to 12, the MIMO Application Framework supports BS configurations with between two and 128 antennas.

Table 3. Multi-Antenna BS Configurations⁶

Number of Antennas	Number of USRP Devices	Number of USRP Subsystems
2	1	1
4	2	1

⁵ The GPSDO is important because it provides improved clock accuracy exploited by the single antenna MS implementation. It also enables GPS-based synchronization and geo-location capability if needed for future system extensions. The USRP-2950/2952/2953/2954/2955/2974 devices contain a GPSDO.

⁶ This is not a complete list of required hardware. For a complete list, contact your local sales representative.

Number of Antennas	Number of USRP Devices	Number of USRP Subsystems
6	3	1
8	4	1
10	5	1
12	6	1
16	8	1
32	16	2
64	32	4

Figure 2. BS

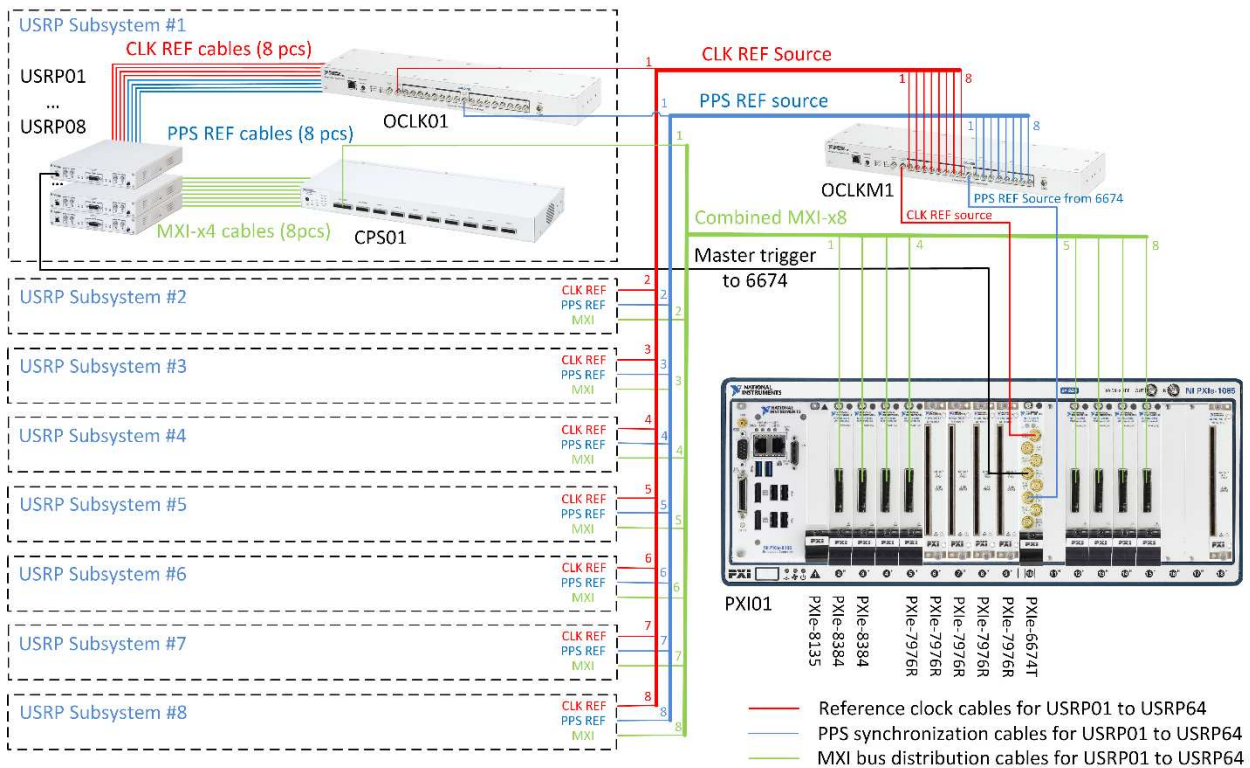

The BS consists of the PXIe-8135 controller, one to eight PXIe-8384 MXI-Express modules for communication with the USRP devices (through the CPS-8910), up to five PXIe-7976 modules (depending on the number of USRP subsystems), and a PXIe-6674T module, installed on the PXIe-1085 chassis. Refer to the “Connection Diagrams” section for the exact connection diagrams for 16-, 32-, 64- and 128-antenna systems.

Clock and synchronization signals are distributed to up to eight USRP subsystems through the CDA-2990 (OCLKM1)⁷. The CDA-2990 provides both clock and time synchronization by amplifying and distributing the 10 MHz reference signal (generated by the PXIe-6674T) and by amplifying and distributing the pulse per second (PPS) signal from the master USRP device. Within the subsystems, another CDA-2990 device

⁷ Not required for the single subsystem configuration (up to 16 antennas), in which both clock and PPS are provided directly from the PXIe-6674T module.

is used to amplify and distribute these signals to the eight USRP devices per subsystems through matched-length cables (shipped with the USRP device).

The system can control up to eight USRP subsystems. Each subsystem consists of eight USRP devices, which are connected to a CPS-8910 device. The maximum system contains up to eight CPS-8910 devices, which are named CPS01 to CPS08. The clock and synchronization signals received by the USRP subsystem are distributed among the eight USRP devices in the subsystem through a CDA-2990 devices. The CDA-2990 devices in the system are named OCLK01 to OCLK08. Figure 3 shows a detailed connections diagram for each USRP subsystem.

Note: The lengths of used cables are critical for timing. The signal path (the sum of the lengths of all cables from the PXIe-6674T module to each USRP device) must be equal for each channel.

Figure 3. Connections in Each USRP Subsystem

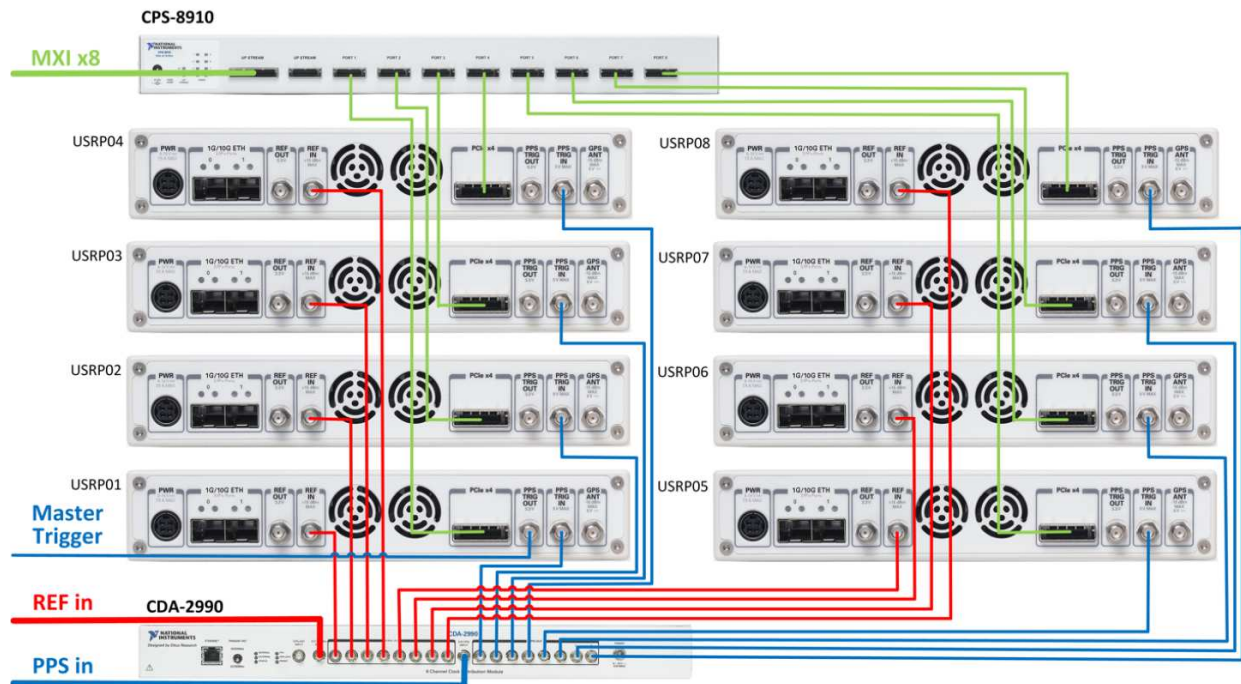

Detailed Hardware Setup

The subsections below provide information about the detailed hardware setup for BSs with different antenna configurations and multi-antenna MSs, which uses the general setup described for a 16-antenna BS (with a potentially reduced number of USRP devices).

Figure 4. 16-Antenna System: Rack 1 of 1

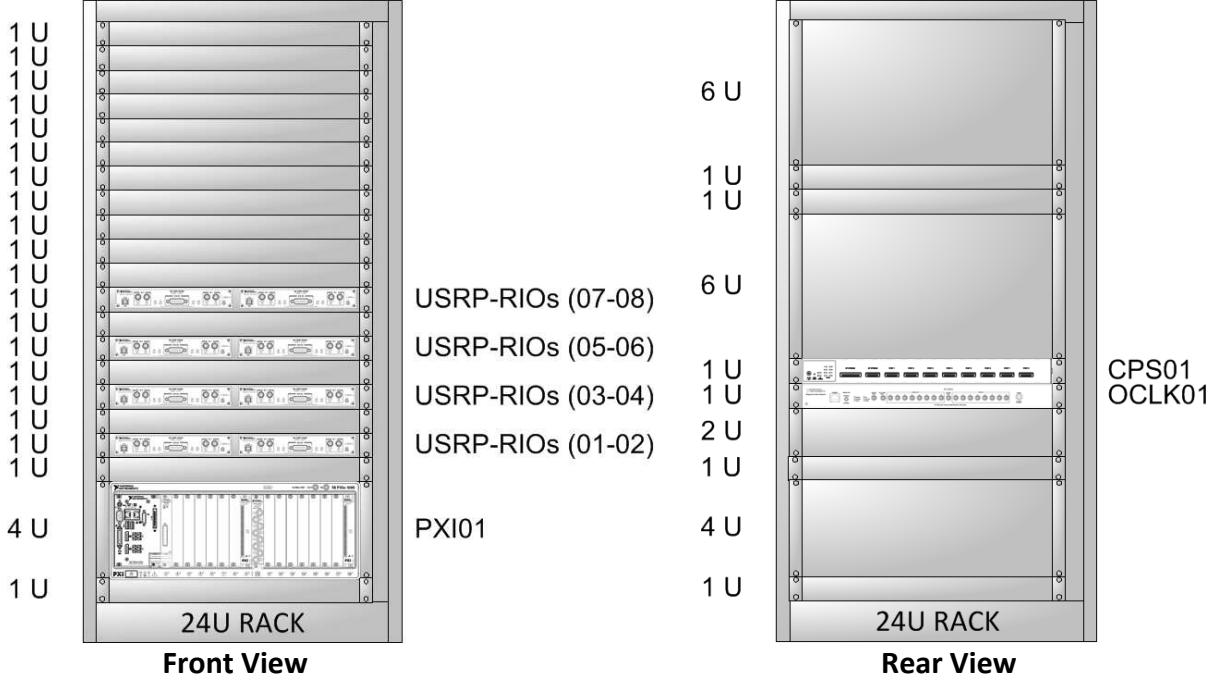

Figure 5. 32-Antenna System: Rack 1 of 1

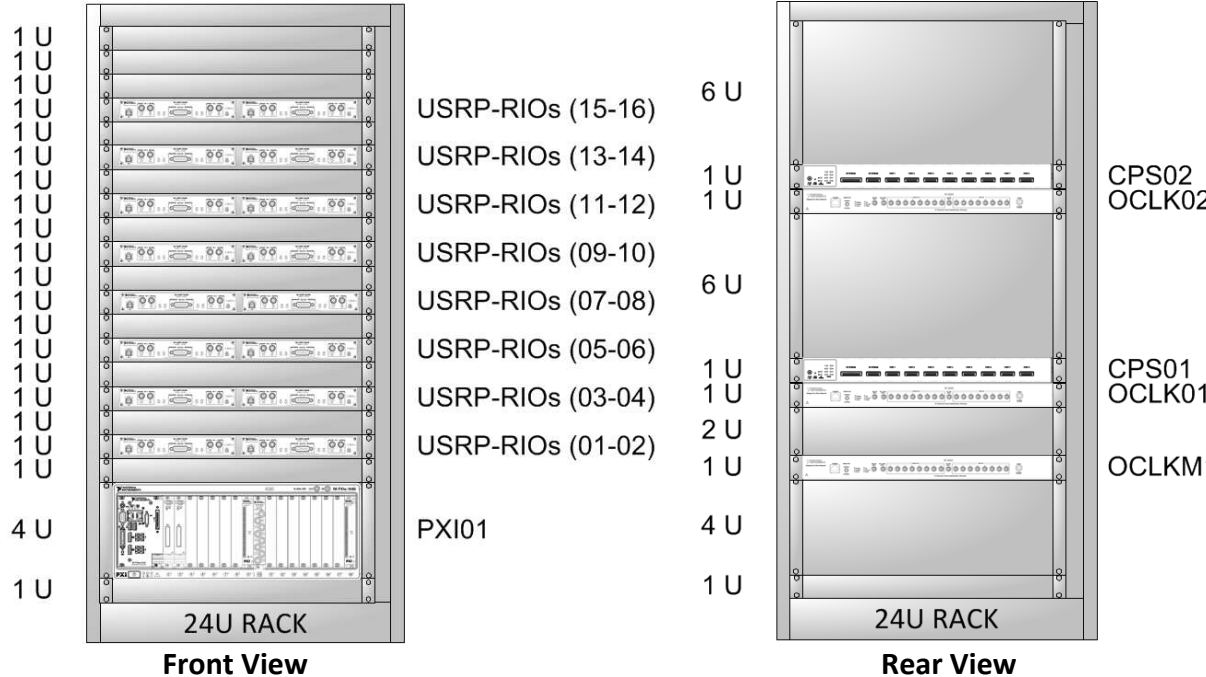

Figure 6. 64-Antenna System: Rack 1 of 2

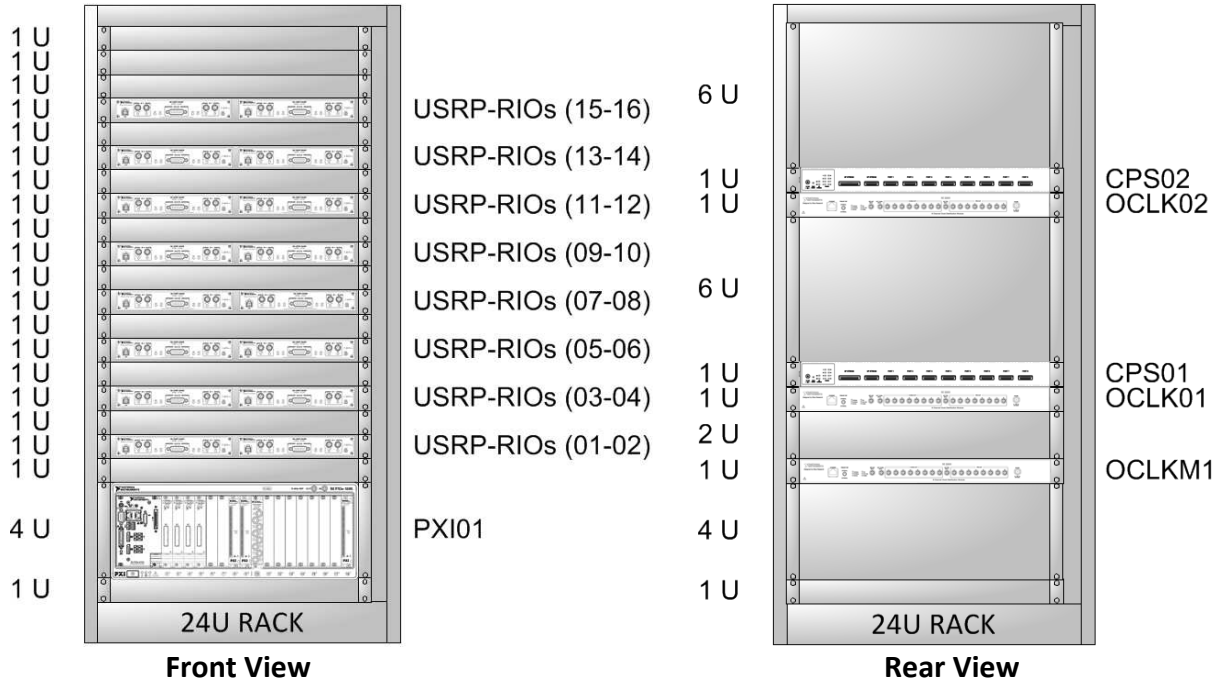

Figure 7. 64-Antenna System: Rack 2 of 2

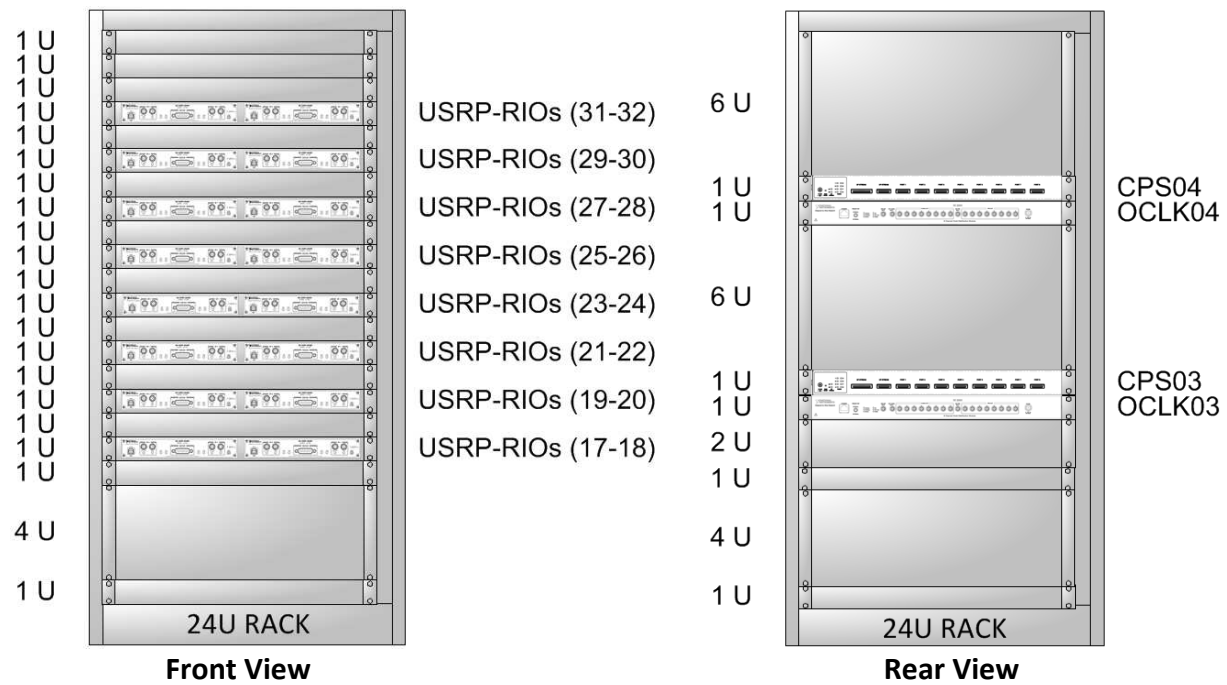

Figure 8. 128-Antenna System: Rack 1 of 4

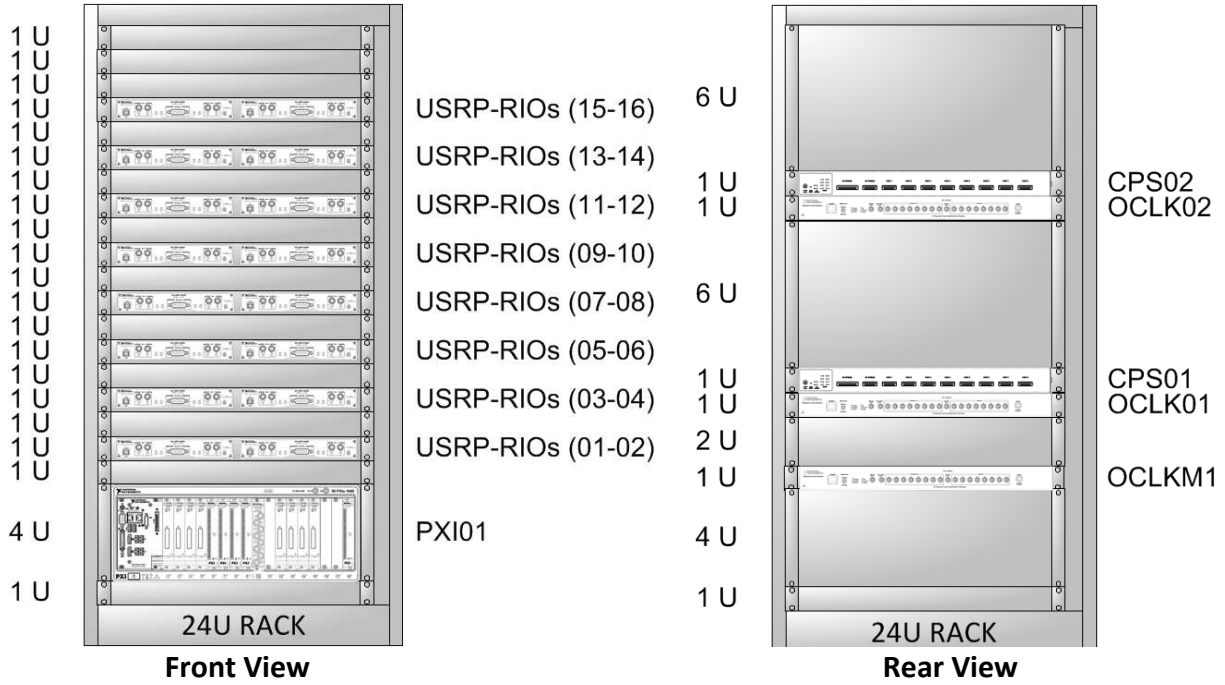

Figure 9. 128-Antenna System: Rack 2 of 4

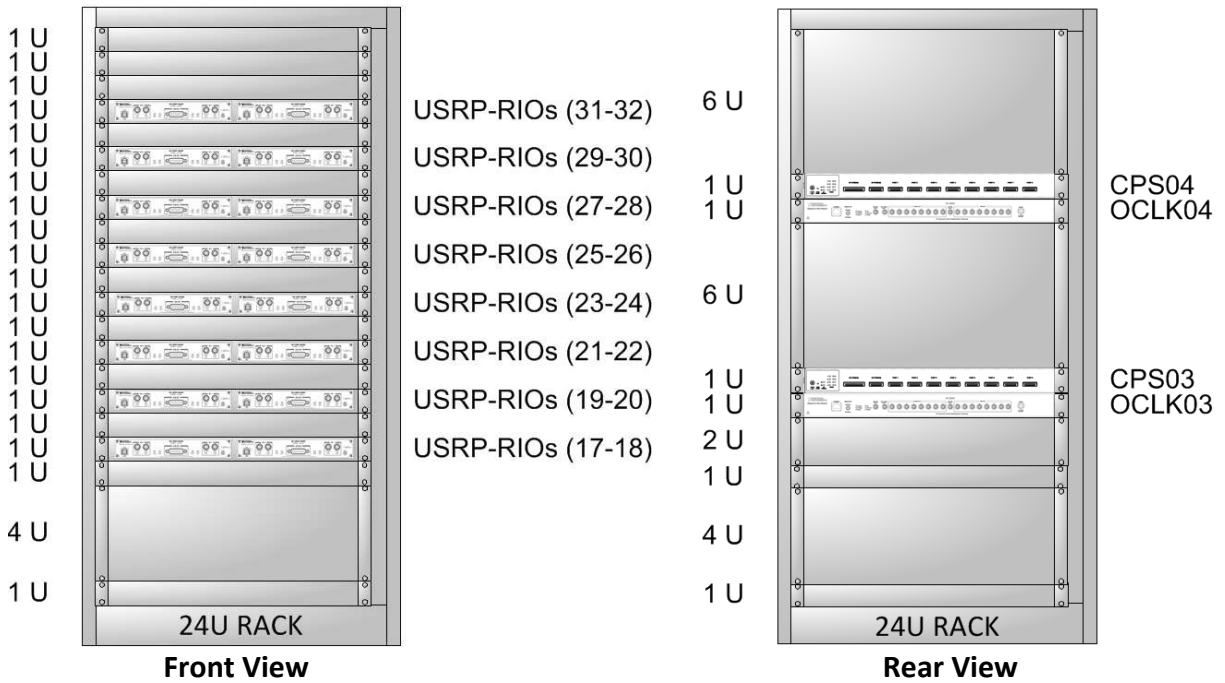

Figure 10. 128-Antenna System: Rack 3 of 4

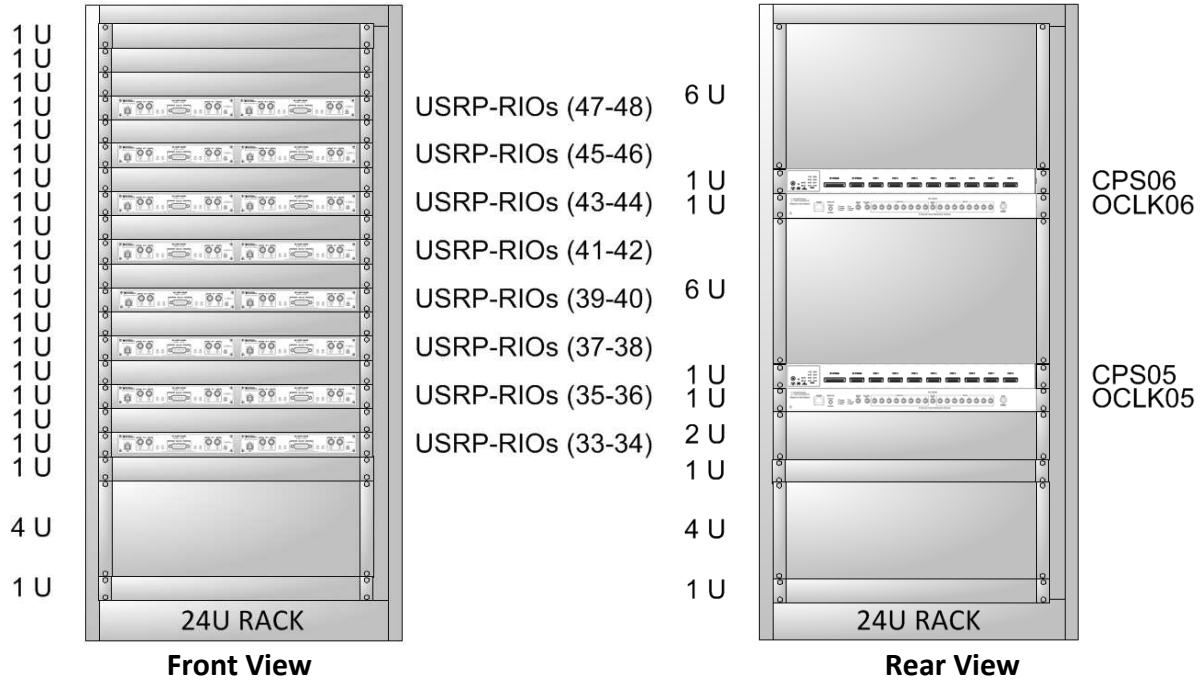
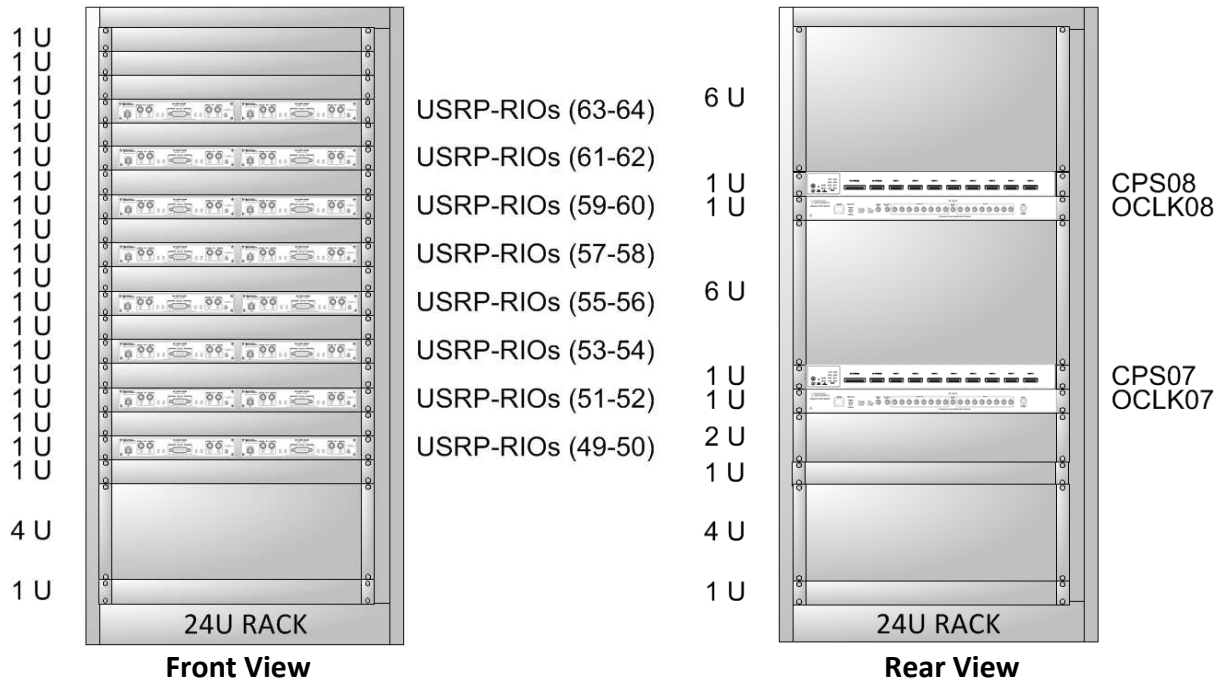

Figure 11. 128-Antenna System: Rack 4 of 4



Installing PXIe Modules

Install the PXIe modules on the chassis in accordance with the configurations shown in the following table.

Table 4. MIMO BS Parts

PXIe-1085 slot #	Number of Antennas (USRP Subsystems)			
	128 (8)	64 (4)	32 (2)	16 (1)
1	PXIe-8135	PXIe-8135	PXIe-8135	PXIe-8135
2	PXIe-8384	PXIe-8384	PXIe-8384	PXIe-8384
3	PXIe-8384	PXIe-8384	PXIe-8384	Slot blocker
4	PXIe-8384	PXIe-8384	Slot blocker	Slot blocker
5	PXIe-8384	PXIe-8384	Slot blocker	Slot blocker
6	PXIe-7976 (FLEX4)	Slot blocker	Slot blocker	Slot blocker
7	PXIe-7976 (FLEX3)	Slot blocker	Slot blocker	Slot blocker
8	PXIe-7976 (FLEX2)	PXIe-7976 (FLEX2)	Slot blocker	Slot blocker
9	PXIe-7976 (FLEX1)	PXIe-7976 (FLEX1)	PXIe-7976 (FLEX1)	PXIe-7976 (FLEX1)
10	PXIe-6674T	PXIe-6674T	PXIe-6674T	PXIe-6674T
11	Slot blocker	Slot blocker	Slot blocker	Slot blocker
12	PXIe-8384	Slot blocker	Slot blocker	Slot blocker
13	PXIe-8384	Slot blocker	Slot blocker	Slot blocker
14	PXIe-8384	Slot blocker	Slot blocker	Slot blocker
15	PXIe-8384	Slot blocker	Slot blocker	Slot blocker
16	Slot blocker	Slot blocker	Slot blocker	Slot blocker
17	Slot blocker	Slot blocker	Slot blocker	Slot blocker
18	PXIe-7976 (FLEX0)	PXIe-7976 (FLEX0)	PXIe-7976 (FLEX0)	PXIe-7976 (FLEX0)

Refer to the “Connection Diagrams” section for detailed connection diagrams.

Cable Connections

Cabled connections between various hardware components of the system are listed in the following tables.

Table 5. Cable Connections within USRP Subsystems

Device #1	Port	Device #2	Port	Cable type and quantity	Description
USRP01 to USRP08	REF IN	CDA	10 MHz OUT 1 to 8	USRP SMA to SMA cable (x8)	Reference clock for USRP
USRP01 to USRP08	PPS TRIG IN	CDA	PPS OUT 1 to 8	USRP SMA to SMA cable (x8)	PPS trigger for USRP
USRP01 to USRP08	PCIe x4	CPS	PORT 1 to PORT 8	MXI (x8)	MXI for USRP

Table 6. Cable Connections between the Master CDA and the CDAs in USRP Subsystems

USRP subsystem #	Port in Master CDA	Port in MIMO subsystem CDA	Cable type	Description	Number of antennas (USRP subsystems)			
					128 (8)	64 (4)	32 (2)	16 (1)
01	10 MHz OUT 1	EXT 10 MHz INPUT	add. SMA to SMA cable	Reference clock for subsystem #1	X	X	X	X
02	10 MHz OUT 2	EXT 10 MHz INPUT	add. SMA to SMA cable	Reference clock for subsystem #2	X	X	X	
03	10 MHz OUT 3	EXT 10 MHz INPUT	add. SMA to SMA cable	Reference clock for subsystem #3	X	X		
04	10 MHz OUT 4	EXT 10 MHz INPUT	add. SMA to SMA cable	Reference clock for subsystem #4	X	X		
05	10 MHz OUT 5	EXT 10 MHz INPUT	add. SMA to SMA cable	Reference clock for subsystem #5	X			
06	10 MHz OUT 6	EXT 10 MHz INPUT	add. SMA to SMA cable	Reference clock for subsystem #6	X			
07	10 MHz OUT 7	EXT 10 MHz INPUT	add. SMA to SMA cable	Reference clock for subsystem #7	X			
08	10 MHz OUT 8	EXT 10 MHz INPUT	add. SMA to SMA cable	Reference clock for subsystem #8	X			
01	PPS OUT 1	EXT PPS INPUT	add. SMA to SMA cable	PPS TRIGGER for subsystem #1	X	X	X	X
02	PPS OUT 2	EXT PPS INPUT	add. SMA to SMA cable	PPS TRIGGER for subsystem #2	X	X	X	

USRP subsystem #	Port in Master CDA	Port in MIMO subsystem CDA	Cable type	Description	Number of antennas (USRP subsystems)			
					128 (8)	64 (4)	32 (2)	16 (1)
03	PPS OUT 3	EXT PPS INPUT	add. SMA to SMA cable	PPS TRIGGER for subsystem #3	X	X		
04	PPS OUT 4	EXT PPS INPUT	add. SMA to SMA cable	PPS TRIGGER for subsystem #4	X	X		
05	PPS OUT 5	EXT PPS INPUT	add. SMA to SMA cable	PPS TRIGGER for subsystem #5	X			
06	PPS OUT 6	EXT PPS INPUT	add. SMA to SMA cable	PPS TRIGGER for subsystem #6	X			
07	PPS OUT 7	EXT PPS INPUT	add. SMA to SMA cable	PPS TRIGGER for subsystem #7	X			
08	PPS OUT 8	EXT PPS INPUT	add. SMA to SMA cable	PPS TRIGGER for subsystem #8	X			

Table 7. Cable Connections between the PXI and the CPS in USRP subsystems

PXIe-8384 in slot #	128 (8)	64 (4)	32 (2)	16 (1)	CPS port	Cable type	Description
	USRP subsystem #						
02	1	1	1	1	UP STREAM	MXI	MXI for subsystem #1 (subsystems #1-#4 for 128 antenna system)
03	2	2	2		UP STREAM	MXI	MXI for subsystem #2 (subsystems #5-#8 for 128 antenna system)
04	3	3			UP STREAM	MXI	MXI for subsystem #3
05	4	4			UP STREAM	MXI	MXI for subsystem #4
12	5				UP STREAM	MXI	MXI for subsystem #5
13	6				UP STREAM	MXI	MXI for subsystem #6
14	7				UP STREAM	MXI	MXI for subsystem #7
15	8				UP STREAM	MXI	MXI for subsystem #8

Table 8. Cable Connections between PXIe-6674T and Master CDA

Output Port on PXIe-6674T	Input Port on CDA	Cable type	Description
CLK OUT	EXT 10 MHz INPUT	add. SMA to SMA cable	Reference clock from PXI
PFI3	EXT PPS INPUT	add. SMA to SMA cable	PPS trigger from PXI

Table 9. Cable Connection between USRP Subsystem #1 and the PXIe-6674T (Master Trigger)

Port on USRP01 in subsystem #1	Port on PXIe-6674T	Cable type	Description
PPS TRIG OUT	PFI1	add. SMA to SMA cable	Master PPS trigger

Connection Diagrams

Figure 12. 16-Antenna MIMO System Connection Diagram

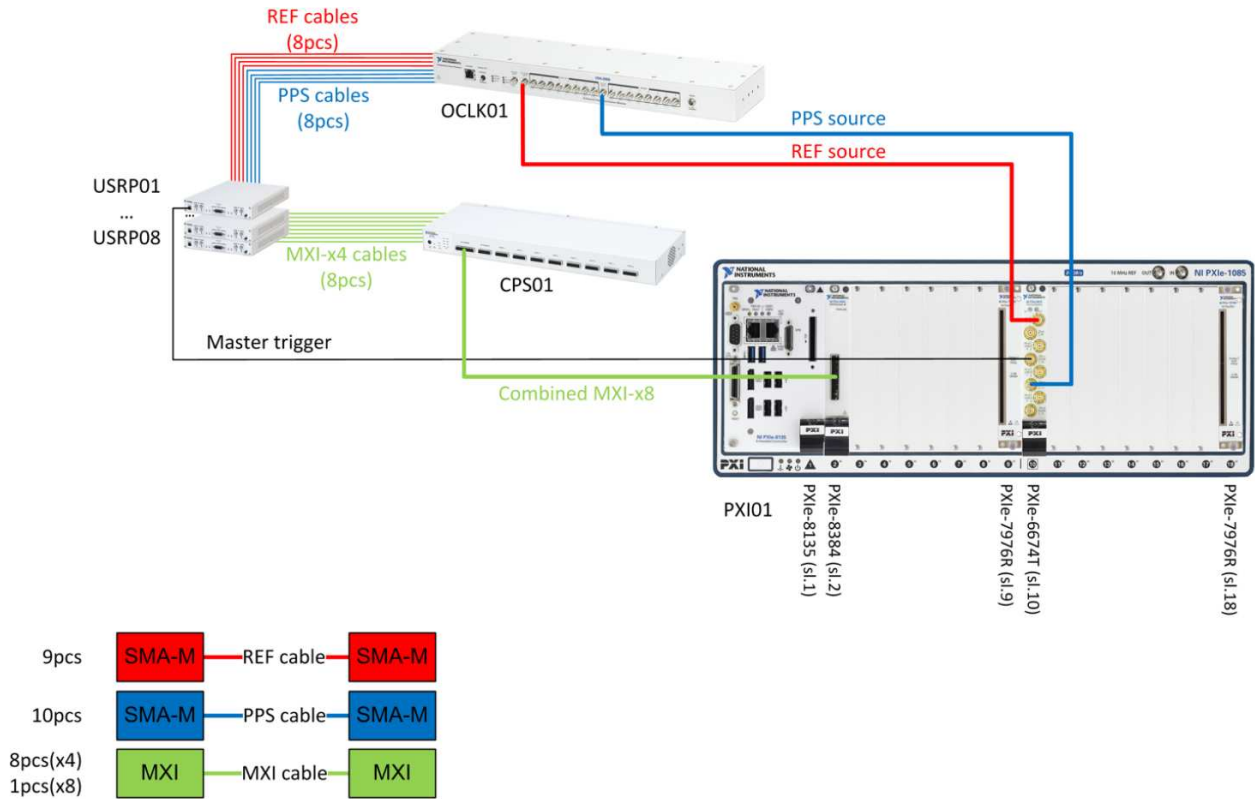

Figure 13. 32-Antenna MIMO System Connection Diagram

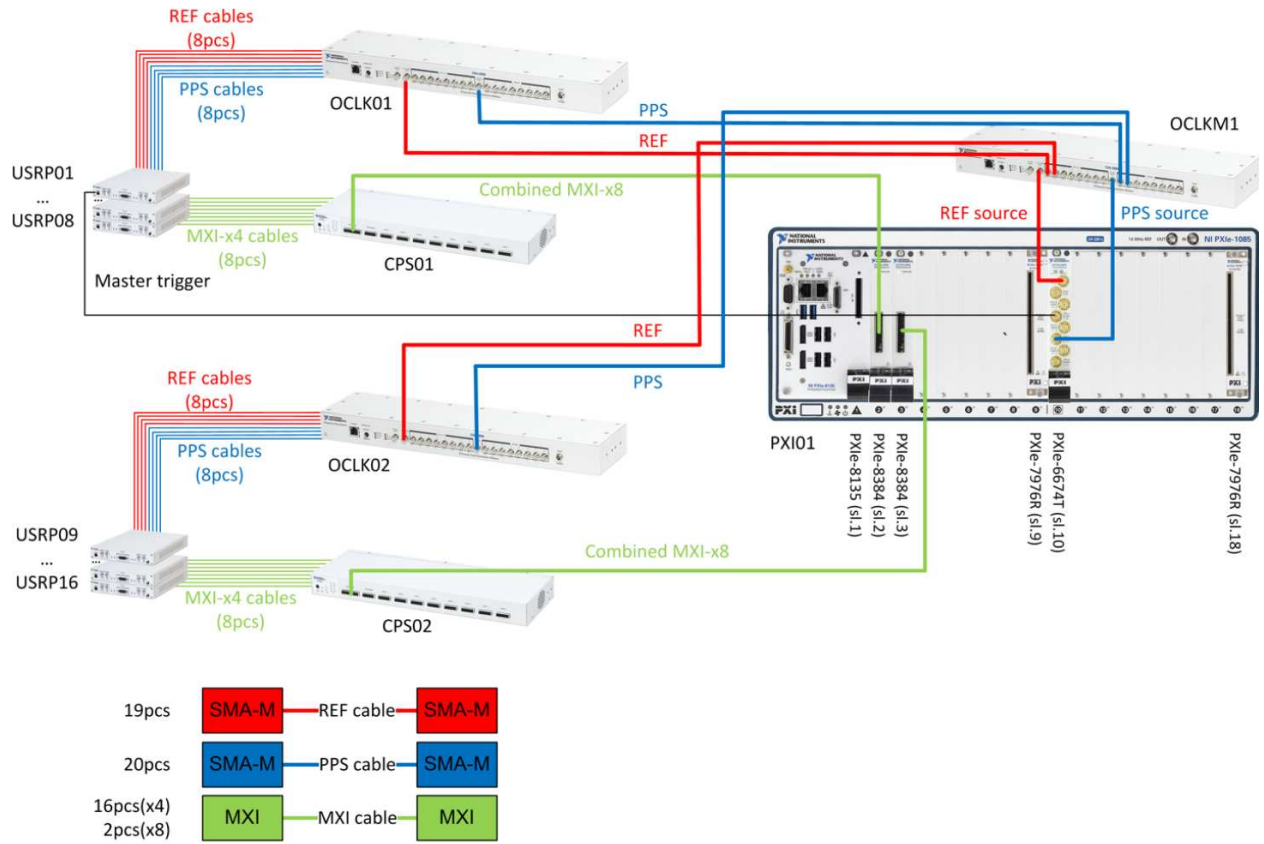

Figure 14. 64-Antenna MIMO System Connection Diagram

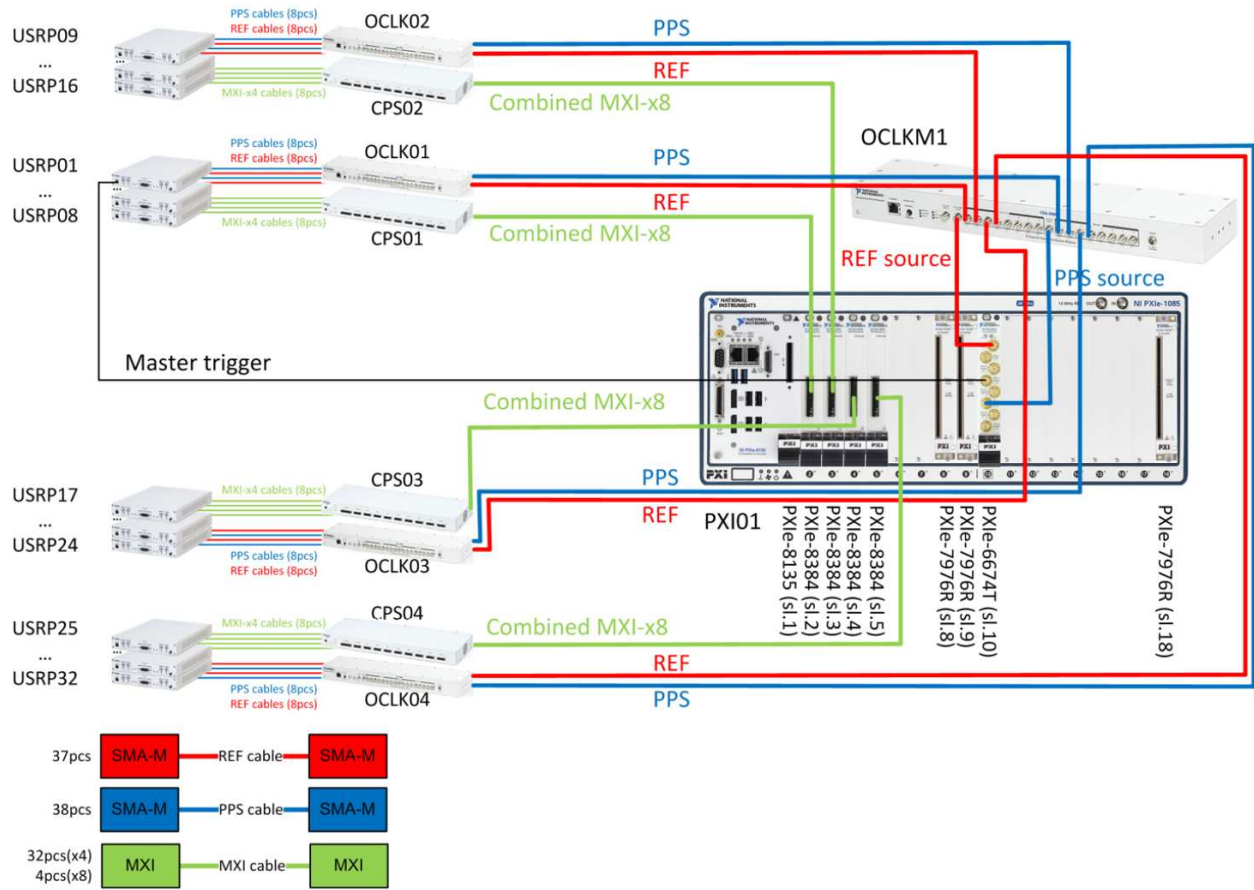
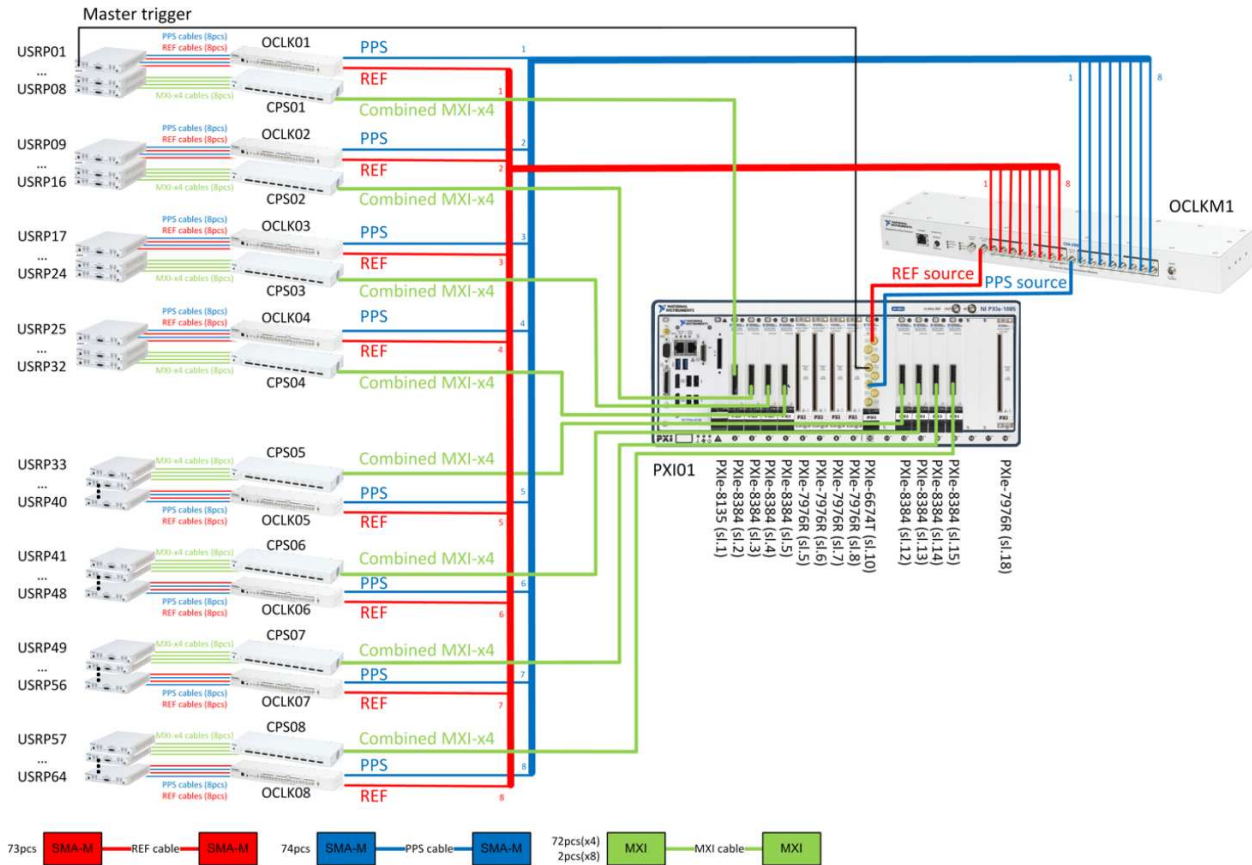

Figure 15. 128-Antenna MIMO System Connection Diagram



Installing the Software

Online Installation

NI installs MIMO Application Framework using NI Package Manager. If you do not already have NI software installed, MIMO Application Framework installs NI Package Manager to handle the installation of your NI software. Visit ni.com/r/NIPMDownload to download NI Package Manager. Refer to the [NI Package Manager Manual](#) for more information about installing, removing, and upgrading NI software using NI Package Manager.

To find MIMO Application Framework in NI Package Manager, select the **Add-Ons** product category in the **Browse Products** tab.

Offline Installation

To download an installer for offline use, visit ni.com/r/MIMOAPPFW to access the installation files download page for the LabVIEW Communications MIMO Application Framework.

Note: LabVIEW Communications System Design Suite is required to run the MIMO Application Framework. If not already installed, visit ni.com/r/commsdriver to access the installation files download page for LabVIEW Communications System Design Suite. A valid serial number for LabVIEW Communications System Design Suite is required to permanently activate the software.

Powering on the Hardware

Notice: Ensure that all SMA connectors are properly tightened. Poor connections may result in a delay in signal propagation, resulting in poor system operation.

Notice: Ensure that the **PRIMARY REF** flip switches on all CDA-2990 devices are in the EXTERNAL position.

Notice: Each USRP device power supply will have a small surge of current draw when plugged in, even if the USRP device is not powered on. If every power supply is connected simultaneously to the same outlet, the circuit breaker may flip. Take the following precautions to avoid this:

- Connect the power supplies to multiple power strips and enabling the power strips sequentially.
- Connect the power supplies one-by-one.
- Power the system on and off using the power button of each USRP device rather than a master switch.
- Use multiple wall outlets on different circuits.

Base Station and Multi-Antenna Mobile Station

1. Power on all the USRP subsystems.
2. Power on the PXI controller.

Single Antenna Mobile Station

1. Power on the USRP device.
2. Power on the computer (laptop, PC, or PXI chassis) to which the USRP is connected.

Software

Hardware Naming

For the BS setups as well as the multi-antenna MS setups, the MIMO Application Framework expects the hardware system components to be named according to a specific naming scheme, as shown in the table below. Use NI MAX, or **System Designer** in LabVIEW Communications, to change the hardware aliases for the listed hardware component if necessary. The MIMO Application Framework is designed to support three different naming schemes, that is, three different sets of hardware aliases. The naming schemes can be selected in the following top-level host nodes in the MIMO Application Framework through the **USRP Naming Scheme** control:

- Base Station Host
- Multi Antenna Mobile Station Host

Table 10. Naming Schemes and Hardware Aliases

Device	USRP Naming Scheme	Aliases
PXIe-6674T	All	TIME
PXIe-7976	All	FLEX0, FLEX1, ..., FLEX4

Device	USRP Naming Scheme	Aliases
USRP	CPS(1-8) Port(1-8)Dev1 Default naming scheme.	CPS1Port1Dev1, CPS1Port2Dev1, ..., CPS1Port8Dev1, CPS2Port1Dev1, CPS2Port2Dev1, ..., CPS2Port8Dev1, and so on. The aliases above are the default names created by MAX for a CPS switch box-based standard HW setup.
	USRP (01-64)	USRP01, USRP02, USRP03, ..., USRP64

Understanding the Components of this Sample Project

The design project is comprised of LabVIEW host code and LabVIEW FPGA code. The related folder structure and components of the project are described in the following subsections. The description covers the Design project, which comprises all FPGA and host software parts. There is a Simulation project limited to the code that is necessary to run simulation tests.

Create a New Design Project Instance

To create a new instance of the MIMO Application Framework, launch LabVIEW Communications System Design Suite by selecting **NI LabVIEW NXG 4.0** from the **Start** menu. From the Project Templates on the launched **Project** tab, select **Application Frameworks » MIMO Design <Version>** to launch the project.

Folder Structure

The following files and folders are created inside the specified folder:

MIMO Design <Version>.lvproject

This project file contains reference to all nodes and targets.

Base Station Host.gcomp

This contains the top-level host node of the BS⁸. The BS implementation realizes a downlink (DL) transmitter (TX) and an uplink (UL) receiver (RX) and can communicate with up to twelve single antenna MSs or a multi-antenna MS with up to twelve antennas.

The BS host interfaces with multiple FlexRIO FPGA modules, which serve as MIMO processor and bit processor units, and with multiple USRP devices, which serve as RRHs. The bitfiles are built from the following corresponding FPGA top-level nodes:

- MIMO Processor FPGA.gcomp:** This is the MIMO Processor top-level FPGA node where the largest part of the in-phase/quadrature (I/Q) baseband signal processing is executed. A MIMO Processor bitfile can be configured to work for up to 32, 64 or 128 antennas. Each bitfile handles either all, half, or a fourth of all subcarriers per orthogonal frequency division multiplexing (OFDM) symbol. Refer to the “System Overview” section for more details.

⁸ Also referred to as the Evolved Node B (eNodeB or eNB), especially in the context of LTE.

- **Bit Processor FPGA.gcomp:** This is the Bit Processor top-level FPGA node where the TX and RX bit processing are executed. The TX packet generator as well as the RX packet validator are also realized in the bit processor.
- **RRH FPGA.gcomp:** This is the RRH top-level FPGA node where the OFDM modulation and demodulation as well as the interfacing with the RF is performed. Refer to the “System Overview” section for more details.

Multi Antenna Mobile Station Host.gcomp

This contains the top-level host node of the multi-antenna MS⁹. The multi-antenna MS implementation realizes an UL TX and a DL RX, which support an even number of TX/RX antennas between 2 and 12. The general hardware-software partitioning is the same as for a (16-antenna) BS.

The multi-antenna MS host interfaces with two FlexRIO FPGA modules, which serve as MIMO processor and as bit processor, and with multiple USRP devices, which serve as RRHs. The related bitfiles are built from the same FPGA top-level nodes which are used for the BS:

- **MIMO Processor FPGA.gcomp**
- **Bit Processor FPGA.gcomp**
- **RRH FPGA.gcomp.**

Single Antenna Mobile Station Host.gcomp

This contains the top-level host node of the single antenna MS⁹ implementation. It is built to control two single antenna MSs in parallel. This host node interfaces with one USRP device where the main part of the DL RX and UL TX signal processing for two parallel MSs is implemented. The corresponding bitfile is built from the following top-level FPGA node:

- **Single Antenna Mobile Station FPGA.gcomp:** This is the single antenna MS top-level FPGA node. It implements two MSs (“MS 0” and “MS 1”), each with a DL RX and UL TX.

Note: As stated above, the described nodes for the single antenna MS always implement two MS in parallel. There aren’t special nodes implementing only one single antenna MS since the MS instances can be deactivate separately. This can be done by setting the layer assignment controls **MS 0 Layer** or **MS 1 Layer** in the top-level host node **Single Antenna Mobile Station Host.gcomp** to value **OFF**.

Builds

This folder contains the precompiled bitfiles.

The FlexRIO modules used as MIMO processors (needed for BSs and multi-antenna MSs) are loaded with MIMO Processor bitfiles. Which bitfile is used specifically depends on which of the following system configurations is used:

- **MIMO Processor 32 Antennas.lvbitx:** Used for BSs with the number of antennas configured between two and 32. It is used also for the multi-antenna MS.
- **MIMO Processor 64 Antennas.lvbitx:** Used for BSs with (up to) 64 antennas.

⁹ Also referred to as the User Equipment (UE), especially in the context of LTE.

- **MIMO Processor 128 Antennas.lvbitx:** Used for BSs with (up to) 128 antennas.

For the bit processing in BSs and multi-antenna MSs, a single FlexRIO module is loaded with the Bit Processor bitfile:

- **Bit Processor.lvbitx:** Used for BS and multi-antenna MS bit processing. It works with all BS configurations.

The USRP devices that serve as RRHs for BSs or multi-antenna MSs are loaded with the following bitfiles:

Table 11. USRP Devices as RRHs

Bitfile	RRH Use	Supported Hardware
RRH Combiner.lvbitx	First RRH in a subsystem	USRP devices with 120 MHz or 160 MHz BW
RRH Splitter.lvbitx	Last RRH in a subsystem	USRP devices with 120 MHz or 160 MHz BW
RRH OFDM Only.lvbitx	All RRHs in a subsystem except the first and the last one	USRP devices with 120 MHz or 160 MHz BW
RRH Combiner 40 MHz.lvbitx	First RRH in a subsystem	USRP devices with 40 MHz BW
RRH Splitter 40 MHz.lvbitx	Last RRH in a subsystem	USRP devices with 40 MHz BW
RRH OFDM Only 40 MHz.lvbitx	All RRHs in a subsystem except the first and the last one	USRP devices with 40 MHz BW

The USRP devices that serve as single antenna MSs are loaded with the following bitfiles:

- **Single Antenna Mobile Station.lvbitx:** Used for USRP RIO devices with 120 MHz or 160 MHz BW.
- **Single Antenna Mobile Station 40 MHz.lvbitx:** Used for USRP RIO devices with 40 MHz BW.

Common

Contains generic host and FPGA nodes that are shared between different application frameworks, such as mathematical functions, type conversions, and so on.

Link Simulator

Contains the Link Simulator which simulates the UL and DL TX chains on the host.

MIMO

Contains host and FPGA nodes and type definitions that were specifically designed for the MIMO Application Framework. It is organized in components that are used on **FPGA** or **Host**, or that are **Shared** between Host and FPGA.

USRP RIO

Contains host and FPGA nodes of the USRP drivers. The nodes are organized into components for **FPGA SubVis**, **Host SubVis** and **Shared** items. The MIMO USRP components for FPGA and USRP contain files from the streaming sample project that were modified for the MIMO Application Framework. The contained nodes can be used for all supported USRP target devices.

Note: This folder was taken from the NI-USRP Multi-device Synchronized Simple Streaming sample project.

Deploy

The **Single Antenna Mobile Station** and **Multi Antenna Mobile Station** can be deployed to a system that does not have LabVIEW Communications System Design Suite installed.

1. Set all configuration parameters that cannot be changed at runtime to their desired value and mark them as default value. For **Single Antenna Mobile Station**, this affects the following parameters: RIO Device, USRP Bandwidth, Sync Mode, Frame Schedule, and RF Frequency. For **Multi Antenna Mobile Station**, this affects the following parameters: USRP Naming Scheme, USRP Bandwidth, Antenna Configuration, Sync Mode, Frame Schedule, and RF Frequency.
2. Save the VI and change to the corresponding component.
3. In the **Document** tab of the component, click **Build**. Wait in the Build queue tab for the build to complete. To find the final executable, right-click on the build and select **Locate item in Windows Explorer**.
4. Copy the executable to the destination machine.

NI automates LabVIEW NXG and LabVIEW Communications System Design Suite installation using NI Package Manager. Visit ni.com/r/NIPMDownload to download NI Package Manager. Refer to the [NI Package Manager Manual](#) for more information about installing, removing, and upgrading NI software using NI Package Manager.

Once the Package Manager is available on the destination machine install the following products:

- LabVIEW Runtime Engine 5.3.2 or later
- NI-USRP 19.5 or later

Note: When installing NI-USRP, ensure that the NI-USRP RIO Runtime dependency is also installed.

Start the mobile station by double click on the executable copied to the destination machine.

Create a New Simulation Project Instance

To create a new instance of the MIMO Application Framework simulation, launch LabVIEW Communications System Design Suite by selecting **NI LabVIEW NXG 4.0** from the **Start** menu. From the Project Templates on the launched **Project** tab, select **Application Frameworks » MIMO Simulation <Version>** to launch the project.

Folder Structure

The folder structure follows the MIMO Design project. There are also two additional components which contains the Host based testbenches (Testbenches.gcomp) as well as the FPGA wrappers (Testbenches FPGA.gcomp).

System Overview

System Features

The MIMO Application Framework offers a ready-to-run design for MIMO prototyping. It comprises a fully-functional PHY for bi-directional transmission as well as basic MAC layer elements. The main features are highlighted below.

- Multi-user MIMO transmission between one BS with up to 128 antennas and up to 12 single antenna MSs.
- Single-user MIMO transmission between one BS with up to 128 antennas and one MS with up to 12 antennas.
- Bi-directional, OFDM-based time-division duplex (TDD) transmission using 20 MHz signal BW.
- Fully re-configurable Long-Term Evolution (LTE)-like radio frame structure.
- Number of MSs or the number of spatial layers per multi-antenna MS can be changed on runtime. The system adapts automatically.
- Scalable number of antennas (multi-antenna MS: between 2 and 12; BS: between 2 and 128). Interfaces and configuration adapt automatically.
- FPGA based real time signal processing such as modulation, over-the-air synchronization, MIMO equalization and MIMO precoding.
- Linear multi-user MIMO precoding and equalization for up to 128×12 antenna systems. Options: Minimum mean squared error (MMSE), zero-forcing (ZF), and maximum-ratio combining (MRC). Multi-user MIMO precoding (at the BS) is channel reciprocity based.
- Automatic channel reciprocity calibration for all radio units at the BS.
- Automatic gain control (AGC) at the BS and MS.
- Variable modulation schemes ranging from 4-quadrature amplitude modulation (QAM) to 256-QAM
- Basic MAC functionality supports packet-based user data transmission in DL and UL to enable data streaming applications, such as video transmission.

Note: Visit ni.com/r/MIMOAppFWManual to access the *LabVIEW Communications MIMO Application Framework Manual* for more information about the MIMO Application Framework design.

System Components

Base Station

The BS components are comprised of the DL TX and the UL RX paths.

Figure 16. Block Diagram of the BS (TX and RX Chain)

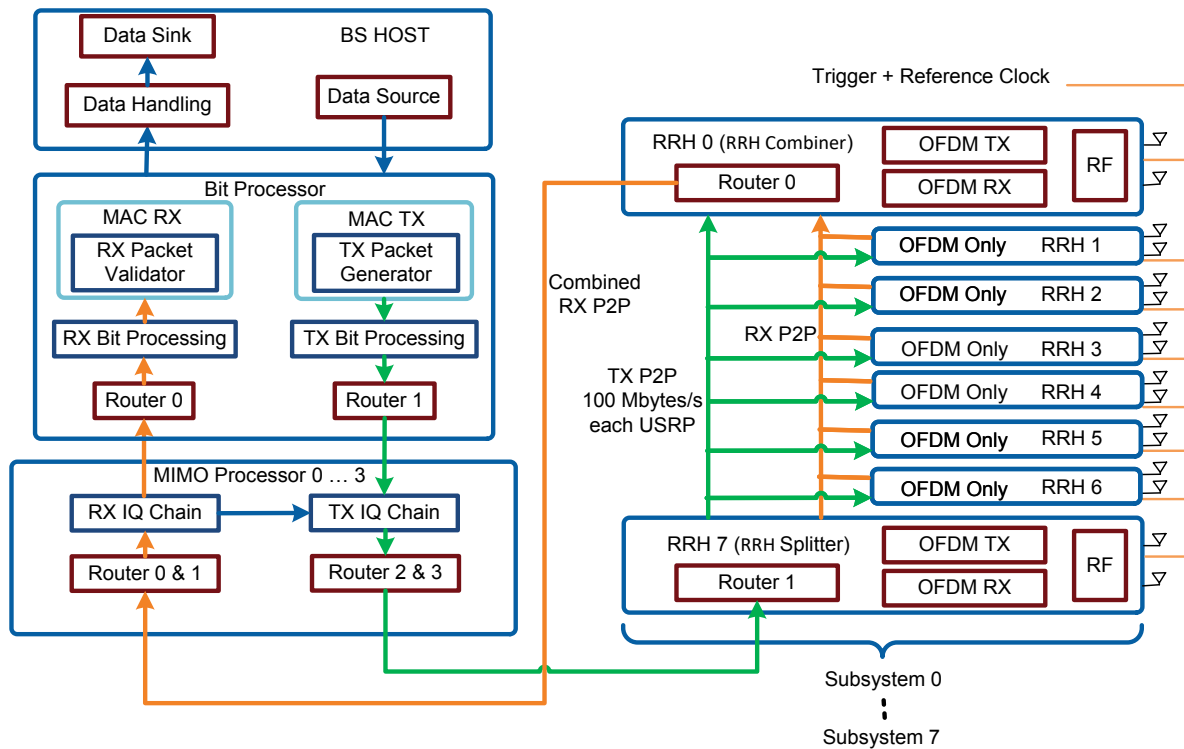

The different BS components and their tasks are described below.

Host: Configures the system and displays the system status. Interfaces with multiple processor bitfiles loaded to the FlexRIO modules and multiple RRH bitfiles loaded to the USRP devices. It also generates or receives and transmits payload data using the user datagram protocol (UDP).

- **Data Handling:** Reads received data from FPGA and stores received payload to queues.
- **Data Source:** Realizes the data source for the DL payload data. It provides the following three operation modes:
 - **UDP:** Payload data is read from the configured UDP ports.
 - **PN data:** Random pseudo-noise (PN) payload data is generated on the host.
 - **OFF:** No payload data is provided from the host. MAC TX will generate zero padding data if needed.
- **Data Sink:** Realizes the data sink for the received UL payload data. It provides the following two operation modes:
 - **UDP:** The received data is sent as UDP packets to the configured remote address and ports.
 - **OFF:** The received data will be discarded.

Bit Processor: Is the central processing unit for TX and RX bit processing. The main components of this module are the following:

- **TX Packet Generator:** Generates the packets based on the MAC packet structure. Visit ni.com/r/MIMOAppFWManual to access the *LabVIEW Communications MIMO Application Framework Manual* for more information.
- **RX Packet Validator:** Performs frame validation by means of frame check sequence (FCS), which contains an IEEE 32-bit cyclic redundancy code (CRC).
- **TX Bit Processing:** Responsible for TX bit processing including data scrambling, TX bit grouping, modulation and data reordering.
- **RX Bit Processing:** Responsible for RX bit processing including data reordering, demapping, packing, and descrambling.
- **Router 0 & 1:** Used for dynamic data routing. Every router has its own routing program, which is written from the host depending on the given system configuration. **Router 0** is used to route the RX data from MIMO processors to the RX bit processing chain. **Router 1** is used to route the transmit data from the TX bit processing chain to the MIMO processors.

MIMO Processors: The central processing units for the frequency-domain TX and RX I/Q Processing. Depending on the system configuration, a MIMO processor processes all, half, or a fourth of the subcarriers OFDM symbol.

- **TX I/Q Chain:** Includes modules such as Precoding, Stream Combiner, and so on.
- **RX I/Q Chain:** Performs the MIMO channel estimation and equalization.
- **Routers:** Used for dynamic data routing. Every router has its own routing program, which is written from the host depending on the given system configuration.
 - **Router 0 & 1:** Used to route RX data from RRH subsystems to the MIMO processor(s).
 - **Router 2 & 3:** Used to route TX data from the MIMO processor(s) to the RRH subsystems.

RRH Subsystem: The RRHs contain the analog-to-digital converters (ADC) and digital-to-analog converters (DAC). They handle the transformation from time-domain to frequency-domain and vice versa. Multiple RRHs (two to eight) build a subsystem. A BS can consist of one to eight subsystems.

- **RRH Splitter (last RRH in subsystem):** Receives the transmit data from the MIMO processors, distributes it to the TX chains of all other RRHs in the subsystem, one after the other, and finally to its own TX chain.
- **RRH Combiner (first RRH in subsystem):** Accumulates the received data from its own RX chain, followed by the RX chains of all other RRHs in a subsystem, one after the other, and sends it to the MIMO processors.
- **OFDM Only RRH:** Named for the other RRHs in a subsystem excluding the first and last RRH.
 - The RX data is transferred to the RRH Combiner through the corresponding peer-to-peer (P2P) stream.
 - The TX data is given from the RRH Splitter through the corresponding P2P stream.
- **OFDM TX and OFDM RX:** Each RRH contains OFDM modulation and OFDM demodulation.
- **RF:** In the TX path, it performs DUC, RF impairments correction, and writes the TX data to the RF. In the RX path, it reads the RX data from the RF, performs DDC and performs RF impairments correction.

Note: If there are two antennas in the BS, only the RRH combiner is used.

The following figure shows the block diagram of the single antenna MS.

Figure 17. Block Diagram of the Single Antenna MS (TX and RX Chain)

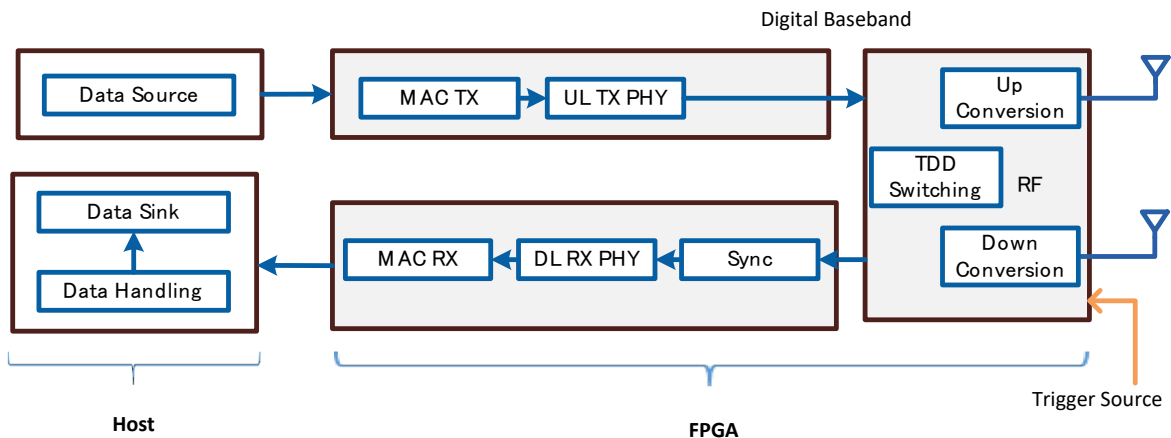

The components shown perform the following tasks:

Host: Configures the FPGA and displays the system status. Interfaces with the MS bitfile.

- **Data Handling:** Reads received data from FPGA and stores received payload to queues.
- **Data Source:** Realizes the data source for the DL payload data. It provides three operation modes
 - UDP: Payload data is read from the configured UDP ports. It is used in the UL Data field of each slot, which is then encoded and modulated as an UL signal by the UL TX (UL TX PHY).
 - PN data: Random PN payload data is generated on the host.
 - OFF: No payload data is provided from the host. MAC TX will generate zero padding data if needed.
- **Data Sink:** Realizes the data sink for the received UL payload data. It provides the following two operation modes:
 - UDP: The received data is sent as UDP packets to the configured remote address and ports.
 - OFF: The received data will be discarded.

FPGA: Contains the MAC and PHY modules for the UL and the DL.

- **MAC TX:** A simple MAC implementation which adds a header containing the number of payload bytes. The header is followed by the payload in bytes and the remaining bytes are filled with padding bytes. The 32-bit CRC is then added.
- **MAC RX:** Packets validator and payload extraction.
- **UL TX PHY:** The PHY of the UL TX creates the UL signal based on the configured frame structure as digital baseband I/Q data. This includes resource mapping, pilot generation, and OFDM modulation.
- **Sync:** Estimates the radio frame start and synchronization parameters. The primary synchronization signal (PSS) is used for frame detection, and frequency and timing offset

estimation. The MS can be synchronized to the BS either using the PSS over-the-air or by using an external trigger signal provided from the BS.

- **DL RX PHY:** The PHY of the DL RX demodulates the DL signal. This includes OFDM demodulation, channel estimation and equalization.
- **Up Conversion:** Performs digital up conversion (from the LTE sampling rate of 30.72 MS/s to 120 MS/s or 200 MS/s, depending on the USRP model), performs RF impairments correction, and writes the resulting TX samples to the RF interface.
- **Down Conversion:** Reads RX samples from the RF interface, performs digital down conversion (from 120 MS/s or 200 MS/s, depending on the USRP model, to the LTE sampling rate of 30.72 MS/s), and performs RF impairments correction.
- **TDD Switching:** Responsible for TX and RX activation based on the frame schedule.

Multi-Antenna Mobile Station

The multi-antenna MS extends the single antenna MS by adding the capability to transmit and receive multiple spatial streams using multiple antennas. It has the same hardware configuration of 16-antenna BS. However, the number of antennas should be even number up to 12. The block diagram is shown in Figure 18. It is similar to that of the BS shown in Figure 16, *Block Diagram of the BS (TX and RX Chain)*, with the following differences:

- **UL TX:** The signal processing is identical to the DL TX signal processing in the BS. The number of active TX antennas is controlled by the number of activated layers. The number of active layers can be selected by the user on the front panel of the top-level host node. Each active layer is mapped to one TX antenna, where the layers with the lowest index is mapped to TX antenna 0, the layer with the second lowest index to TX antenna 1, and so on.
- **DL RX:** The RX implementation including *channel estimation*, *equalizer Computation*, and *linear equalization* blocks is similar to BS UL RX implementation. Only a synchronization and tracking unit is added to the RX chain. The synchronization is identical to the single antenna MS. A single RX antenna is used for synchronization as well as for tracking. The user can select from the front panel of **Multi Antenna Mobile Station Host.gvi** either RF0 or RF1 of the RRH combiner, the first RRH in the system, to be the synchronization reference. The synchronization results are then transferred in a daisy chain to the other RRHs as it is shown in the following figure.

Note: The DL RX processing always runs for all RX antennas.

Figure 18. Block Diagram of the Multi-Antenna MS (TX and RX Chain)

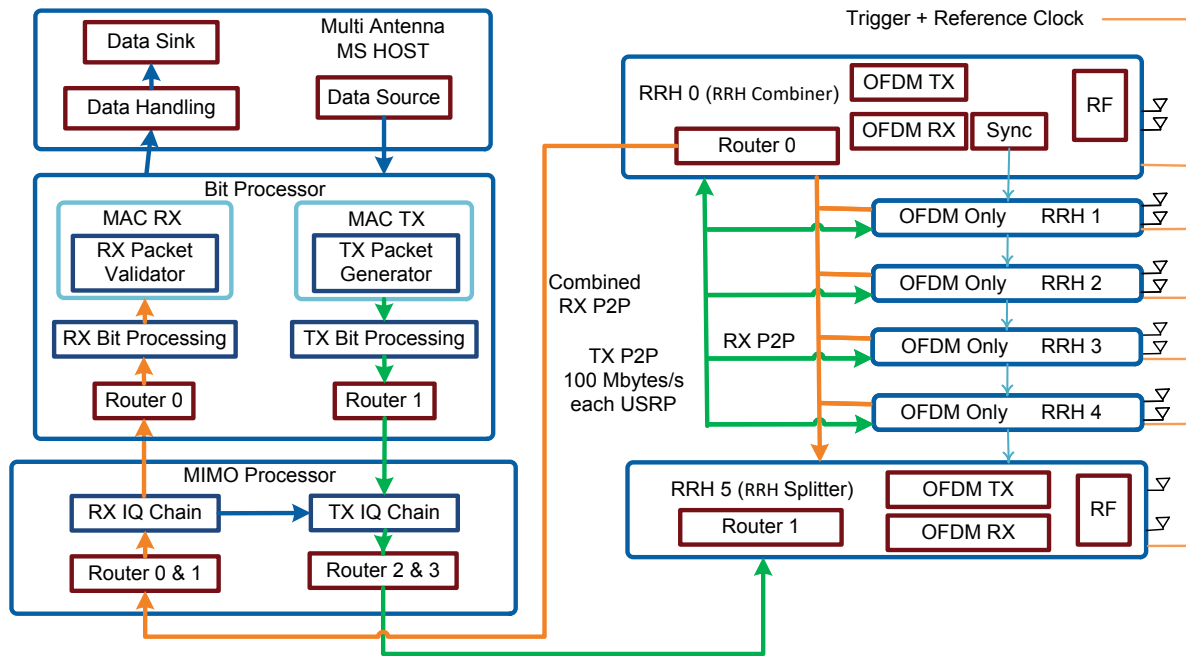

Running the LabVIEW Host Code

Ensure you meet the hardware and software requirements before trying to run the host code.

On the BS Host Computer

1. Launch LabVIEW Communications System Design Suite by selecting **NI LabVIEW NXG 4.0** from the Start menu.
2. From the Project Templates on the launched **Project** tab, select **Application Frameworks**, then select **MIMO Design** to launch the project.
3. Within that project, open **Base Station Host.gvi** (located in **Base Station Host.gcomp**). The front panel of this node is shown in Figure 19.
4. Set the following configurations in **Base Station Host.gvi**:
 - a. Set the **USRP Naming Scheme** depending on the hardware aliases that you configured using MAX, as described in Table 10, *Naming Schemes and Hardware Aliases*.
 - b. Set the **USRP Bandwidth Model** depending on the hardware model of your USRP devices.
 - c. Set the **System Configuration** control to the required configuration.
 - d. Set the **RF Frequency** to a frequency supported by your USRP devices.¹⁰
 - e. Set the AGC mode to auto or manual. If the AGC is configured to manual, set the **TX power** in dBm and **RX gain** in dB that are available in the **RRH** tab or keep the default values.
5. Run the **Base Station Host.gvi** by clicking the run button (▶).
 - If successful, the **Base Station Active** indicator lights.

¹⁰ Consider local laws if you are transmitting over-the-air. USRP and USRP RIO devices are not approved or licensed for transmission over-the-air using an antenna.

- If an **error** is indicated, go to the **Error** tab to check the error message. Here you will also see if an error occurred during the initialization of the timing module, the MIMO Processors, the Bit processor or the RRHs. The **first failing element** tells which module could not be initialized correctly. Use MAX to check if the failing module is configured with the correct hardware alias.

Figure 19. Front Panel of BS (Configuration Tab)

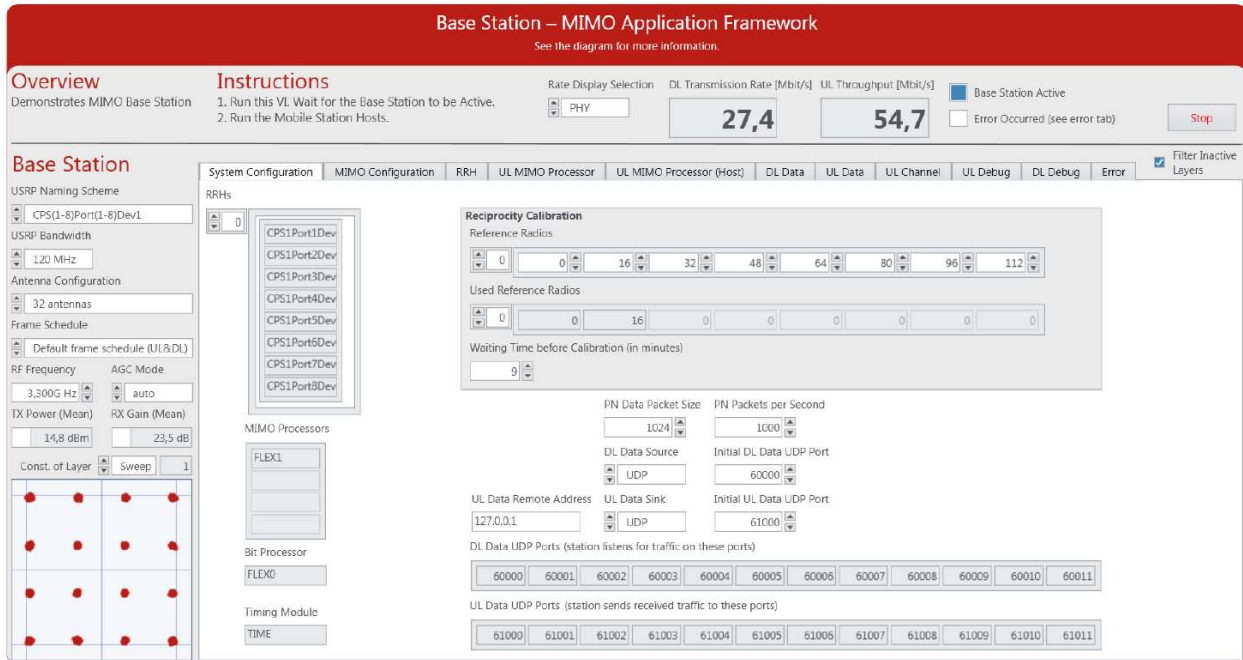

On the Single Antenna MS Host Computer

1. Launch LabVIEW Communications System Design Suite by selecting **NI LabVIEW NXG 4.0** from the Start menu.
2. From the Project Templates on the launched **Project** tab, select **Application Frameworks**, then select **MIMO Design** to launch the project.
3. (USRP-2974 only) Ensure you are mapped to the RT target.
 - a. Open SystemDesigner in Design view.
 - b. Select the USRP device.
 - c. On the Configuration pane, check that **Hostname** names the correct USRP and Status is **Matched**.
 - d. If **Status** is **Not matched**, select the ... button.
 - e. Select your device from the **Use a different controller** dropdown menu or select **Add Hardware»Add hardware by address** to add your device using the IP address of your device. You are now mapped to the correct device.
4. Within that project, open **Single Antenna Mobile Station Host.gvi** located in **Single Antenna Mobile Station.gcomp**. The front panel of this node is shown in Figure 20.
5. (USRP-2974 only) Select the RT target by selecting the **Single Antenna Mobile Station RT Host** instead of the default target (**PXI Controller**).
6. Set the following configurations in **Single Antenna Mobile Station Host.gvi**.
 - a. Configure the RIO identifier in the **RIO Device** control.

- Use MAX to configure the hardware alias of the USRP device that you want to use as MS.
 - (USRP-2974 only) Set the **RIO Device** to RIO0 instead of the default name of USRPUE.
- b. Set the **USRP Bandwidth Model** depending on the hardware model of your USRP devices.
 - c. Select the synchronization mode using the **Sync Mode** control.
 - d. Set the **RF Frequency** per the BS.¹¹
 - e. Set the AGC mode to auto or manual. If the AGC is configured to manual, set the **TX power** in dBm and **RX gain** in dB that are available in the **AGC Settings and Status** tab.
 - f. Set the MS ID of both MSs (**MS 0 UE ID** and **MS 1 UE ID**). Each MS ID has its modulation scheme as shown in Figure 20.
5. Run **Single Antenna Mobile Station Host.gvi** by clicking the run button (▶).
 - If successful, the **Mobile Stations Ready** indicator lights.
 - If an error is indicated, go to the **Error** tab to check the error message. Use MAX to check if the USRP device is configured with the correct hardware alias.

If you want to transmit and receive with more than two single antenna MSs (one MS host), you have two options:

1. Use different host computers. For example, use one laptop with one USRP device connected to it per MS host.
2. Use the same host computer (for example, a PXI chassis) with multiple USRP device connected to it. To run multiple MS hosts, you must duplicate **Single Antenna Mobile Station Host.gvi**.

When using multiple MS hosts, the above configurations should be repeated for each MS host. Please make sure to select the correct **RIO Device** each time and to choose unique **UE IDs**. When using the same UE ID twice the BS will not be able to decode the UL because it receives a mixed signal with the same UL pilots and the same UL data scrambling sequence.

¹¹ Consider local laws if you are transmitting over-the-air. USRP and USRP RIO devices are not approved or licensed for transmission over-the-air using an antenna.

Figure 20. Front Panel of Single Antenna MS (Configuration Tab)

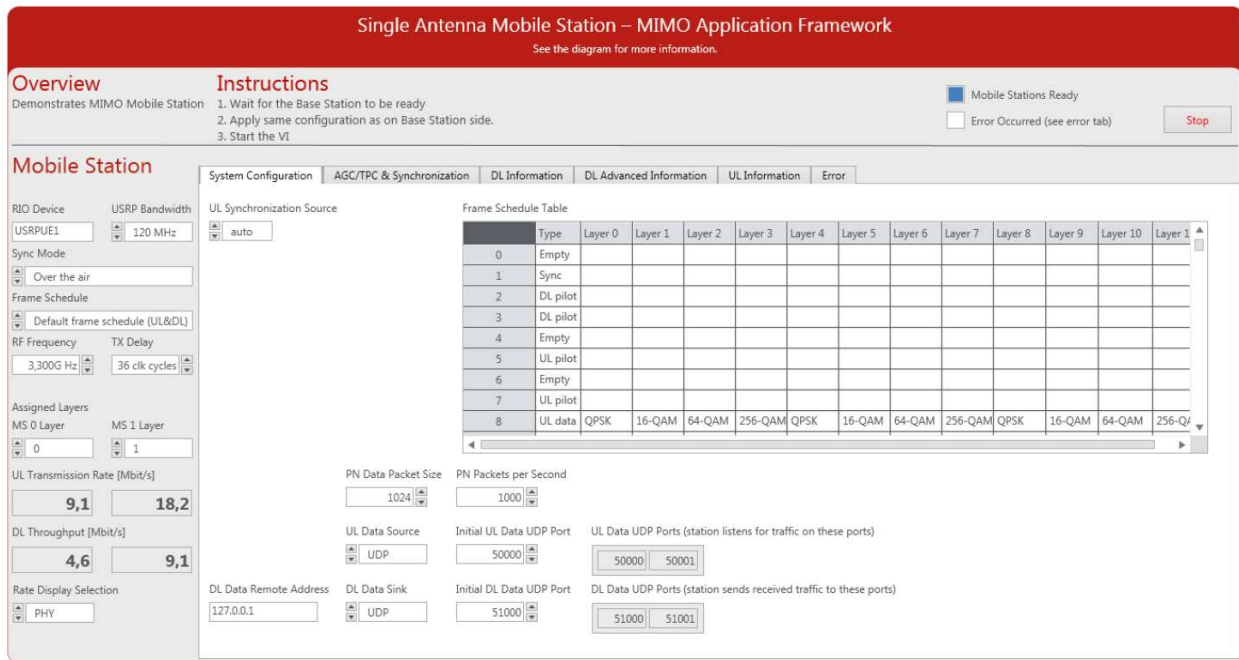

On the Multi-Antenna MS Host Computer

1. Launch LabVIEW Communications System Design Suite by selecting **NI LabVIEW NXG 4.0** from the Start menu.
2. From the Project Templates on the launched **Project** tab, select **Application Frameworks**, then select **MIMO Design** to launch the project.
3. Within that project, open **Multi Antenna Mobile Station Host.gvi** located in **Multi Antenna Mobile Station.gcomp**. The front panel of this node is shown in Figure 21.
4. Set the following configurations in **Multi Antenna Mobile Station Host.gvi**:
 - a. Set the **USRP Naming Scheme** depending on the hardware aliases that you configured using MAX as shown in Table 10, *Naming Schemes and Hardware Aliases*.
 - b. Set the **USRP Bandwidth Model** depending on the hardware model of your USRP devices.
 - c. Set the **System Configuration** control to the required configuration.
 - d. Set the **RF Frequency** to a frequency supported by your USRP devices.¹²
 - e. Set the AGC mode to auto or manual. If the AGC is configured to manual, set the **TX power** in dBm and **RX gain** in dB that are available in the **AGC** tab or keep the default values.
 - f. Assign the active layers that are available in the **Layer mapping** tab.
5. Run the **Multi Antenna Mobile Station Host.gvi** by clicking the run button (▶).
 - If successful, the **Mobile Station Active** indicator lights.
 - If an **error** is indicated, go to the **Error** tab to check the error message. Here you will also see if an error occurred during the initialization of the timing module, the MIMO processors, the Bit processor or the RRHs. The **first failing element** tells which module

¹² Consider local laws if you are transmitting over-the-air. USRP and USRP RIO devices are not approved or licensed for transmission over-the-air using an antenna.

could not be initialized correctly. Use MAX to check if the failing module is configured with the correct hardware alias.

For multi-antenna MS, the active layers should be assigned up to twelve. If multiple multi-antenna MS will be used, the assigned layers of each MS should be different from the others. When using the same layer identity twice the BS will not be able to decode the UL because it receives a mixed signal with the same UL pilots and the same UL data scrambling sequence.

Figure 21. Front Panel of Multi-Antenna MS (MIMO Configuration Tab)

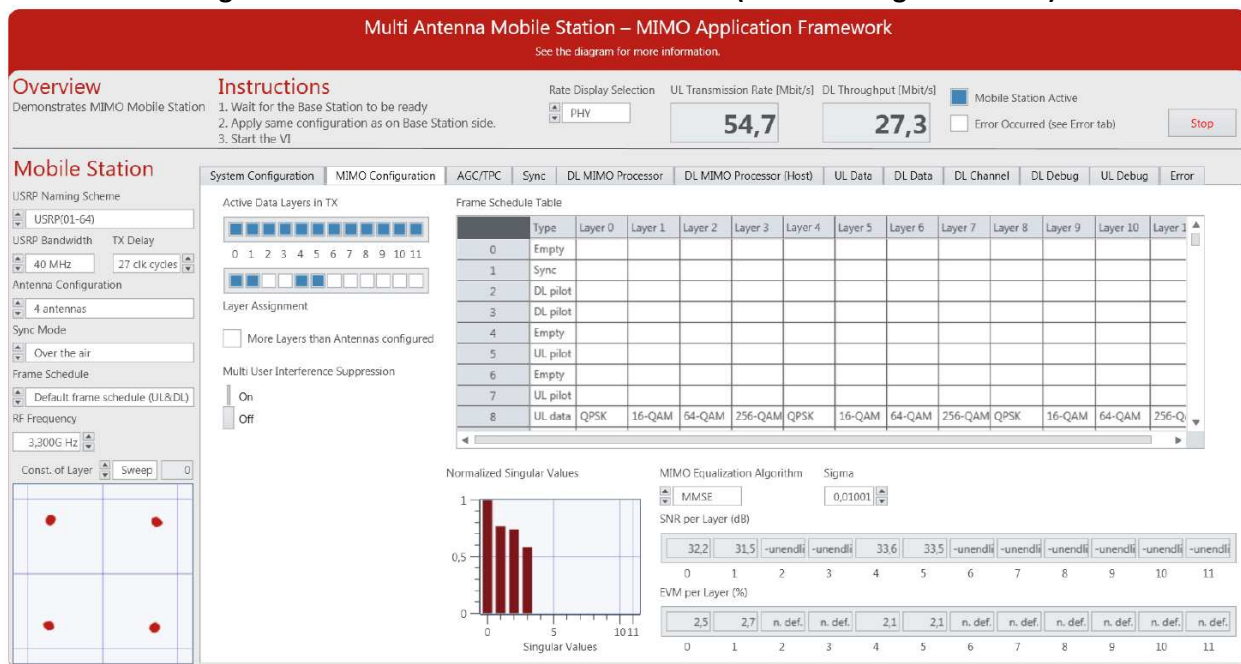

System Running Verification

Complete the following steps to verify that the system is running.

1. Select the **Frame Schedule Table** in the **Configuration** tab on the **Base Station Host.gvi** to find the modulation scheme of the selected MSs.
2. For UL investigation, select the **UL MIMO Processor** tab on the **Base Station Host.gvi**, and verify that the presented RX constellations match the corresponding modulation schemes according to the **Frame Schedule Table**. When using the default frame schedule MS 0 should have quadrature phase-shift keying (QPSK) modulation and MS 1 should have 16 QAM modulation. Furthermore, select the **UL Data** tab and verify the UL throughput.
3. Based on the MS mode either single antenna MS or multi-antenna MS, the DL investigation can be done as the following:
 - **Single Antenna Mobile Station Host.gvi:** Select the **DL Advanced Information** tab and verify that the presented RX constellations match the corresponding modulation schemes according to the **Frame Schedule Table**. Furthermore, select the **DL Information** tab and verify the DL throughput.
 - **Multi Antenna Mobile Station Host.gvi:** Select the **DL MIMO Processor** tab and verify that the presented RX constellations match the corresponding modulation schemes

according to the **Frame Schedule Table**. Furthermore, select the **DL Data** tab and verify the DL throughput.

4. **Refine Timing synchronization:** If the constellation of the measured data at the BS is rotated, the user should refine the timing synchronization. The **Signal Delay** graphical indication on the **RRH** tab shows the estimated time delay in LTE samples of all MSs or of all layers in case of using multi-antenna MS. This graphical representation can be used to calibrate the time delay by using the **MS TX Delay** control on the **Configuration** tab of **Single Antenna Mobile Station Host.gvi** and that on the **System Configuration** tab of **Multi Antenna Mobile Station Host.gvi**.

Running Video Streaming

The MIMO Application Framework implements a basic MAC functionality which allows for bi-directional packet-based data exchange of user-defined payload data. Figures 22 and 23 show simple example use cases where user-defined data is transferred in the UL using a multi-antenna MS or multiple single antenna MSs, respectively. The user-data is received at the MS from a data source in form of UDP packets and send out at the BS to a data sink also in form of UDP packets. Any program capable of transmitting UDP data can serve as a data source. Similarly, any program capable of receiving UDP data can serve as a data sink.

If you use a video streaming application as a data source and a video player as a data sink, the MIMO Application Framework can be used for video streaming. The following section describes video streaming using the VLC media player, which is available at www.videolan.org.

Start Video Stream at the Transmitter (MS)

The MS host acting as an UL transmitter receives UDP packets from the video streaming application and utilizes the MIMO Application Framework to transmit the data frames.

1. Create a new project as described in **Running the LabVIEW Host Code** section.
2. For single antenna MS: Open the top-level host node of the MS, **Single Antenna Mobile Station Host.gvi**, set the correct RIO identifier in the **RIO device** parameter, and then set **UL Data Source** on the **Configuration** tab to **UDP**.
3. For multi-antenna MS: Open the top-level host node of the MS, **Multi Antenna Mobile Station Host.gvi**, set the USRP naming scheme and the system configuration (even number and up to 12 antennas), and then set **UL Data Source** on the **System Configuration** tab to **UDP**.
4. For single antenna MS, user can configure the initial value of **UL Data UDP Port** of the first MS. The UDP port of the second MS on **Single Antenna Mobile Station Host.gvi** is equal to the initial value plus one.
5. Run the LabVIEW host node by clicking the run button (▶).
6. Start `cmd.exe` and change the directory to the VLC installation directory.
7. Start the VLC application as a streaming client with the following command:

```
vlc.exe --repeat "PATH_TO_VIDEO_FILE"  
      :sout=#std{access=udp{ttl=1},mux=ts,dst=@:UDP_PORT_TX}
```

where `PATH_TO_VIDEO_FILE` should be replaced with the location of the video that should be used. The value of `UDP_PORT_TX` is 50.000, which is the default UDP Receive Port for MS ID 0. The default UDP receive port can be changed using the **Initial UL Data UDP Port** control on

the **Configuration** tab in **Single Antenna Mobile Station Host.gvi** or **System Configuration** tab in **Multi Antenna Mobile Station Host.gvi**.

For multi-antenna MS, one UDP port is used. The above command should be run once. When using multiple single antenna MSs, each MS host opens two UDP ports for the two RF chains. The **UL UDP Data Ports** indicator shows the used ports.

If you have a single host computer (PXI chassis) with multiple USRP devices connected to it, you must change the value of `UDP_PORT_TX`. The first **Single Antenna Mobile Station Host.gvi** can use the default while the second **Single Antenna Mobile Station Host.gvi** should use a different value—for example 53,000—and so on.

If you are using different host computers, you do not need to change the value of `UDP_PORT_TX`.

Figure 22. Data Streaming from a Multi-Antenna MS to the BS Using UDP

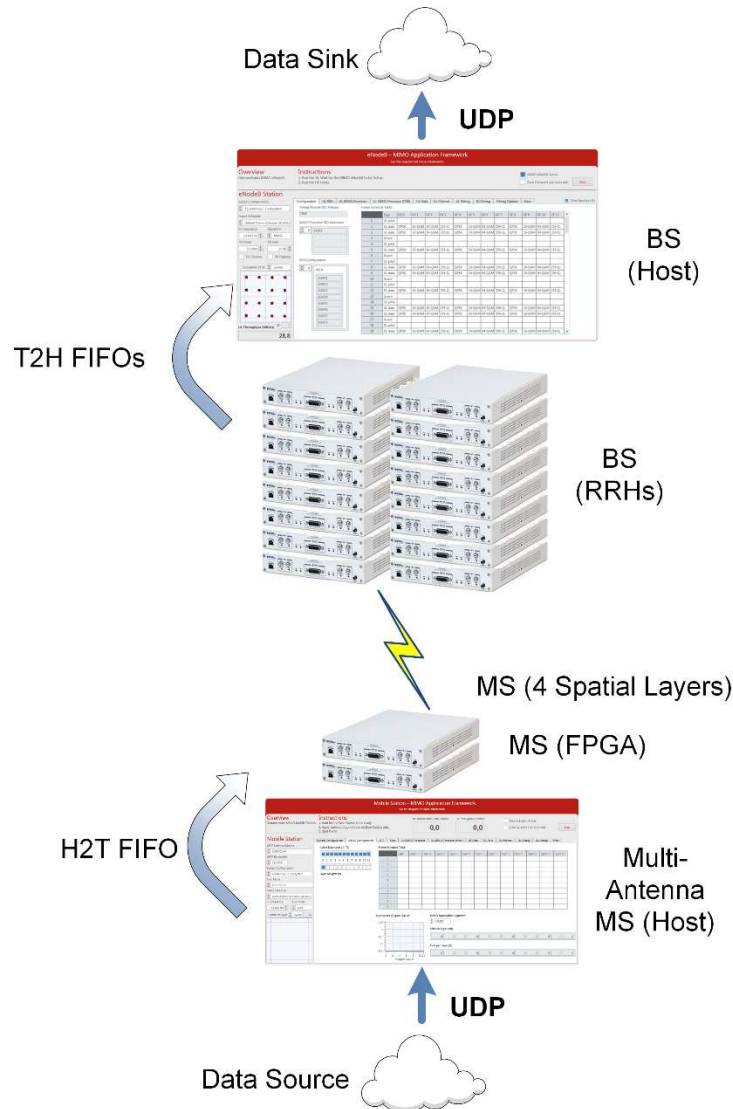
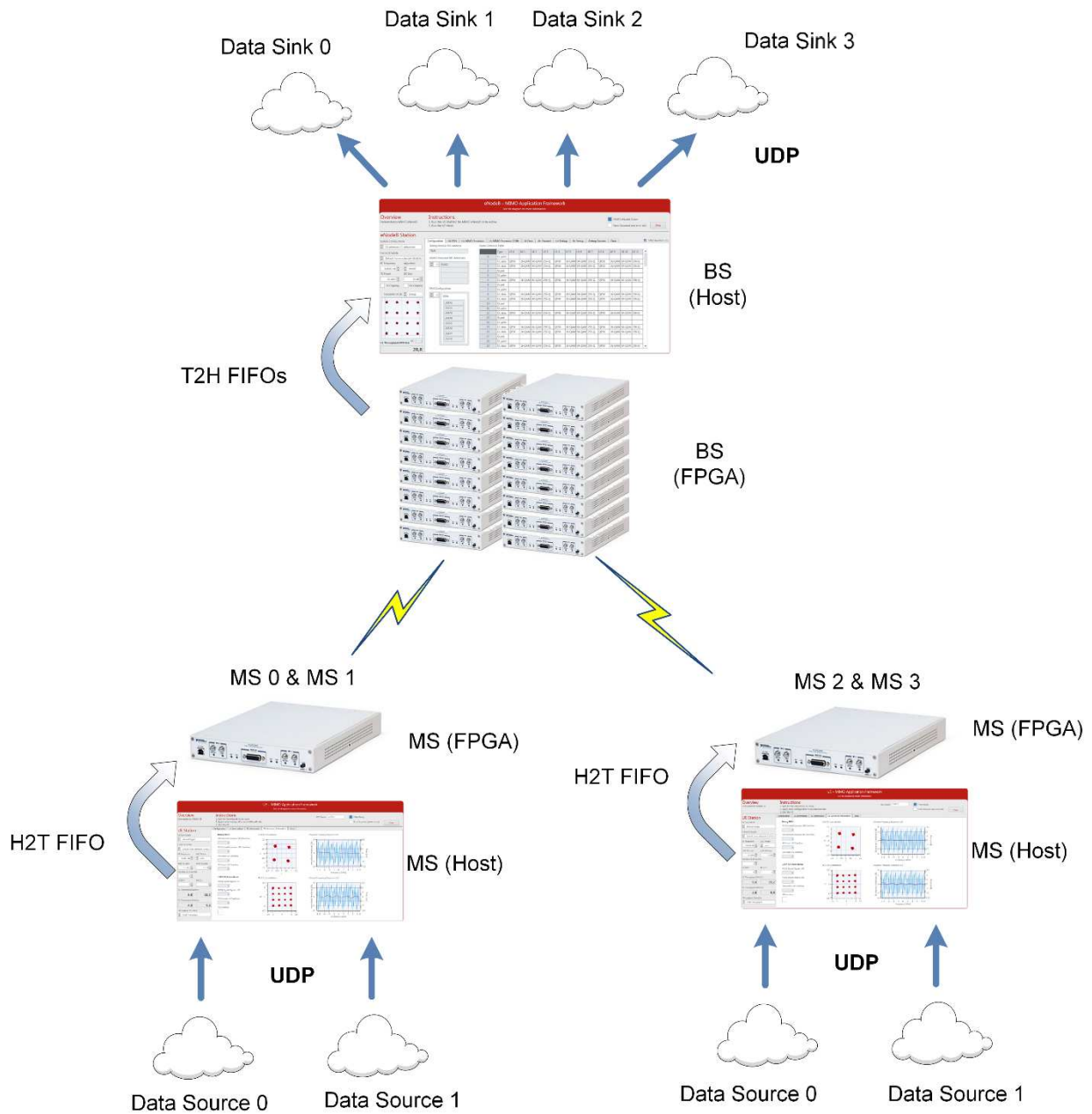

Figure 23. Data Streaming from Multiple Single Antenna MSs to the BS Using UDP



Start Video Stream at the Receiver (BS)

The BS host acting as a receiver uses the MIMO Application Framework to validate the received data frames and pass them through UDP to the video player.

1. Create a new project as described in “Running the LabVIEW Host Code” section.
2. Open the top-level host node of the BS, **Base Station Host.gvi**, and then switch to **System Configuration** tab and set **UL Data Sink** to **UDP**.
3. Run the LabVIEW host node by clicking the run button (▶).
4. Start `cmd.exe` and change the directory to the VLC installation directory.

- Start the VLC application as a streaming client with the following command:

```
vlc.exe udp://@:UDP_PORT_RX
```

The value of `UDP_PORT_RX` is 61.000, which is the default UDP Transmit Port. The default value of `UDP_PORT_RX` can be changed using the **Initial UL Data UDP Port** control on **Configuration** tab. The `UDP_PORT_RX` values is derived as an **Initial UL Data UDP Port** plus the MS identity.

Description of Controls and Indicators

Description of Controls and Indicators on the BS Host Front Panel

This section describes all controls, graphs and indicators which are placed on the BS host front panel.

BS Basic Controls and Indicators

Several controls and indicators are placed outside the main tab control of **Base Station Host.gvi** as shown in Figure 19, *Front Panel of BS (Configuration Tab)*. The following tables list the corresponding controls and indicators.

Table 12. BS Host – Main Panel Controls

Control	Uses Runtime	Description
USRP Naming Scheme	No	Determines the naming scheme of the USRP devices which are loaded with the RRH bitfiles. The enumeration contains the following values: <ul style="list-style-type: none"> CPS(1-8)Port(1-8)Dev1 PXI(2-5)Slot(2-18)Port1Dev1 USRP(01-64)
USRP Bandwidth	No	Determines the BW of the used USRP devices. The enumeration contains the following values: <ul style="list-style-type: none"> 160 MHz 120 MHz 40 MHz
Antenna Configuration	No	Determines the number of antennas in the system. The typedef of antenna configuration can be modified to have any even number between 2 and 128.
Frame Schedule	No	Determines the frame schedule to use.
RF Frequency	No	The center frequency for radio transmission and reception. ¹³
AGC Mode	Yes	Selects the AGC mode: manual or auto . If the AGC is manual, go to the RRH tab to adjust the TX Power and RX gain.
Const. of Layers	Yes	Selects the layer identity for the constellation plot below. Set to sweep to sweep through the layers over time. If the Filter Inactive Layers control is active, the sweeping will include only the active layers.
Filter Inactive Layers	Yes	Filters inactive layers in several graphs, for example, the constellation plots.

¹³ Consider local laws if you are transmitting over-the-air. USRP and USRP RIO devices are not approved or licensed for transmission over-the-air using an antenna.

Control	Uses Runtime	Description
Rate Display Selection	Yes	<p>Selects the displaying rate type of UL Throughput [Mbit/s] and DL Transmission Rate [Mbit/s] indicators:</p> <ul style="list-style-type: none"> • PHY: Shows the packet data rate. • MAC: Shows the payload throughput. <p>If the DL Data Source and UL Data Sink controls under System Configuration tab are set to UDP without running the video streaming, the displayed DL Transmission Rate and UL Throughput are zeros if the Rate Display Selection is set to MAC.</p>

Table 13. BS Host – Main Panel Indicators and Graphs

Indicator	Description
TX Power (Mean)	Numerical indication shows the mean coerced value of all antennas that currently used as maximum RF transmit output power level after applying the device's capabilities (range and resolution limitations) to the configured Requested TX Power [dBm] in the RRH tab or the calculated value if AGC is auto.
RX Gain (Mean)	Numerical indication shows the mean coerced value of all antennas that currently applied at all antennas. This value is the manual RX gain when AGC is manual or the calculated RX gain when AGC is auto. In both cases, the gain value is coerced by the capabilities of the device.
TX Clipping	Indicates a numeric overflow at the output of DAC. It is located beside TX Power (Mean) indicator.
RX Clipping	Indicates a numeric overflow at the output of ADC. It is located beside RX Gain (Mean) indicator.
Equalized Subcarriers	Shows the constellations of the selected layer using Const. of Layer control or of all layers in sweep.
UL Throughput [MBit/s]	Numerical display showing the total UL throughput in Mbit/s.
DL Transmission Rate [MBit/s]	Numerical display showing the total DL transmission rate in Mbit/s.
Base Station Active	A Boolean indicator that indicates the BS is ready.
Error Occurred (see error tab)	A Boolean indicator that lights up if an error occurred.

BS Indicators on System Configuration Tab

The following tables list the controls and indicators that are placed on the Configuration tab of **Base Station Host.gvi** as shown in Figure 19, *Front Panel of BS (Configuration Tab)*.

Table 14. BS Host - Controls on System Configuration Tab

Control	Uses Runtime	Description
Reciprocity Calibration	No	<p>Sets the required parameters of reciprocity calibration process. Those are the Reference Radios and the Waiting Time before Calibration.</p>

Control	Uses Runtime	Description
Reference Radios	No	Selects the reference radios for reciprocity calibration. NI recommends that you have at least one reference radio per subsystem. The first RRH of each subsystem is selected by default.
Waiting Time before Calibration (in minutes)	No	Sets the waiting time after bit files download to the FPGAs. Recommended: 9 minutes.
PN Data Packet Size	Yes	Size of packets in PN data transmission mode. There will be always the same packet transmitted over all configured layers.
PN Packets per Seconds	Yes	Number of packets transmitted in PN mode per seconds.
DL Data Source	Yes	Has three options: <ul style="list-style-type: none"> • Off: No data is transmitted in DL. • UDP: Received UDP packets are transmitted to the corresponding layer in DL. • PN Data: A random packet is transmitted at PN packets per second rate on all active layers.
Initial DL Data UDP Port	No	An offset to start opening UDP ports for UDP packet reception. The default UDP Transmit Port is 60.000. For each layer, the corresponding UDP port value is 60.000 plus the layer identity.
UL Data Remote Address	Yes	IP address that the packets received from UL are sent to.
UL Data Sink	Yes	Has two options: <ul style="list-style-type: none"> • Off: Received data is discarded. • UDP: Received frames are forwarded to the configured UDP address and port.
Initial UL Data UDP Port	No	Offset to start opening UDP ports for UDP packet transmission. The default UDP Receiver Port is 61.000. For each layer, the corresponding UDP port value is 61.000 plus the layer identity.

Table 15. BS Host - Indicators on System Configuration Tab

Indicator	Description
RRHs	Shows the RIO aliases of active USRP devices per subsystem.
MIMO Processors	Shows the addresses of active FlexRIO modules for I/Q processing.
Bit Processor	Shows the address of active FlexRIO module for bit processing.
Timing Module	Shows the address of Timing Module RIO card.
Used Reference Radios	Effectively used reference radio. The list contains the configured reference radio reduced to the available radios.
DL Data UDP Ports	Shows the UDP ports to forward traffic to the layers. For multi-antenna MS, single UDP port is used.
UL Data UDP Ports	Shows the UDP ports to forward traffic from the layers. For multi-antenna MS, single UDP port is used.

BS Control and Indicators on MIMO Configuration Tab

The following tables list the controls and indicators placed on the **MIMO Configuration** tab of **Base Station Host.gvi** as shown in Figure 24.

Table 16. BS Host - Controls on MIMO Configuration Tab

Control	Uses Runtime	Description
Active Data Layers in TX	Yes	Selects the layer identity manually.
One per UE	Yes	If it is true, the UE-ID equals the layer number. Otherwise, choose from the following options: <ul style="list-style-type: none"> All layers can be assigned to single UE-ID for multi-antenna MS. The user-to-layer mapping can be custom-configured for multi single antenna MSs.
All for UE	Yes	If true, all layers will be assigned to single UE-ID given by the numerical control beside All for UE control. Otherwise, it is a custom configuration using the Boolean array under One per UE and All for UE controls.
Boolean Matrix	Yes	For custom configuration, click to enable or disable layers by clicking the matrix element to map UE (row) to layer (column). Use One per UE or All for UE buttons for default settings. The system prevents assigning a layer to multiple UEs and enforces at least on assigned layer.
MIMO Equalization Algorithm	Yes	Configures the algorithm that is used for equalization. The enumeration contains the following values: MMSE, MRC, and ZF.
Sigma	Yes	Selects the scaling factor that is used in the modified Gram-Schmidt QR decomposition (MGS-QRD) algorithm of the MMSE channel estimator.

Table 17. BS Host - Indicators on MIMO Configuration Tab

Indicator	Description
Active Layers Detected in RX	Shows the active layers that has been detected in the BS.
Frame Schedule Table	Shows the OFDM Frame Schedule of all 12 layers. The OFDM symbol types of each layer frame (140 OFDM Symbols) are presented. The OFDM symbol type could be Guard, Sync, DL pilot, DL data, UL pilot, and UL data. In addition, the modulation schemes of all layers are presented, which could be QPSK, 16-QAM, 64-QAM, and 256-QAM. The Frame Schedule Table indicator is controlled by the Frame Schedule control.
Normalized Singular Values	The Singular Value Decomposition of the channel estimates at different antennas and different subcarriers is used to get the singular values. A proper threshold can be selected by the user to estimate the channel rank. The effective number of spatial streams can then be identified.
SNR per Layer (dB)	A numerical array shows the measured signal-to-noise ratio (SNR) (dB) for all active layers.

Indicator	Description
EVM per Layer (%)	A numerical array shows the measured error vector magnitude (EVM) defined as a percentage for all active layers. The earned value of EVM indicates to the quality of measurements. A small value of EVM (%) leads to a small block error rate (BLER).

Figure 24. Front Panel of BS (MIMO Configuration Tab)

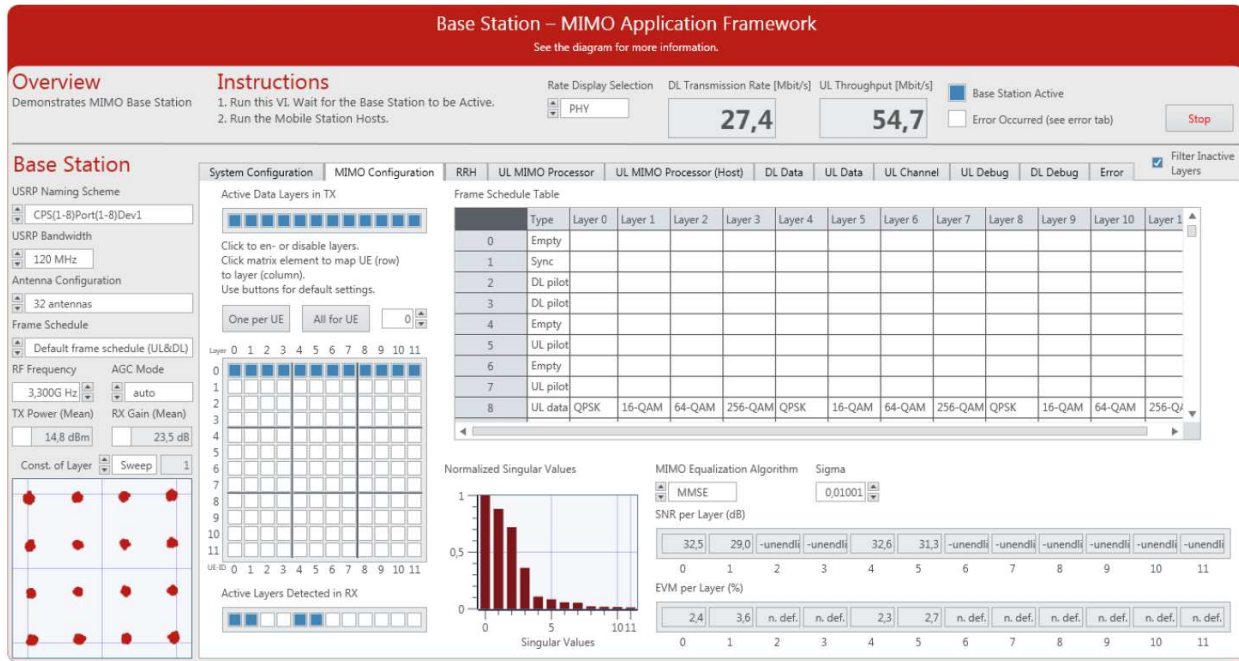

BS Control and Indicators on RRH Tab

The following tables list the controls and indicators placed on the **RRH** tab of **Base Station Host.gvi** as shown in Figure 25.

Table 18. BS Host - Control on RRH Tab

Control	Runtime	Description
Select Antenna	Yes	Determines the antenna for which the received subcarriers are shown on this tab.
Requested TX Power	Yes	Sets the BS RF TX power in dBm.
Manual RX Gain	Yes	Sets the BS RF RX gain in dB.
AGC Target Midpoint	Yes	Target RX power in digital baseband used in AGC mode auto . The optimal value depends on the peak-to-average power ratio (PAPR) of the received signal. Decrease the default setting if the PAPR increases, for instance, if the number of spatial layers is increased.

Table 19. BS Host – Graphs and Indicators on RRH Tab

Indicator	Description
Lower limit	Boolean indicator that shows whether the configured Requested TX Power value is coerced to the allowed range.
Upper limit	Boolean indicator that shows whether the configured Requested TX Power value is coerced to the allowed range.
UL RRH max Symbol Power [dBFS]	Graphical indication shows the maximum signal strength of a radio frame (calculated on OFDM symbol basis) over all antennas.
Amplitude of Received Subcarriers	Graphical indication shows the amplitude of received subcarriers of the selected antenna. The antenna can be selected using Select Antenna control that is located on the above side of the figure.
Signal Delay [Samples]	Graphical indication shows the estimated time delay of all layers in LTE samples. This graphical representation can be used to calibrate the time delay of each layer manually by using the MS TX Delay control on the Configuration tab of Single Antenna Mobile Station Host.gvi top-level and the IO TX Delay control on the Sync tab of Multi Antenna Mobile Station Host.gvi top-level.

Figure 25. Front Panel of BS (RRH Tab)

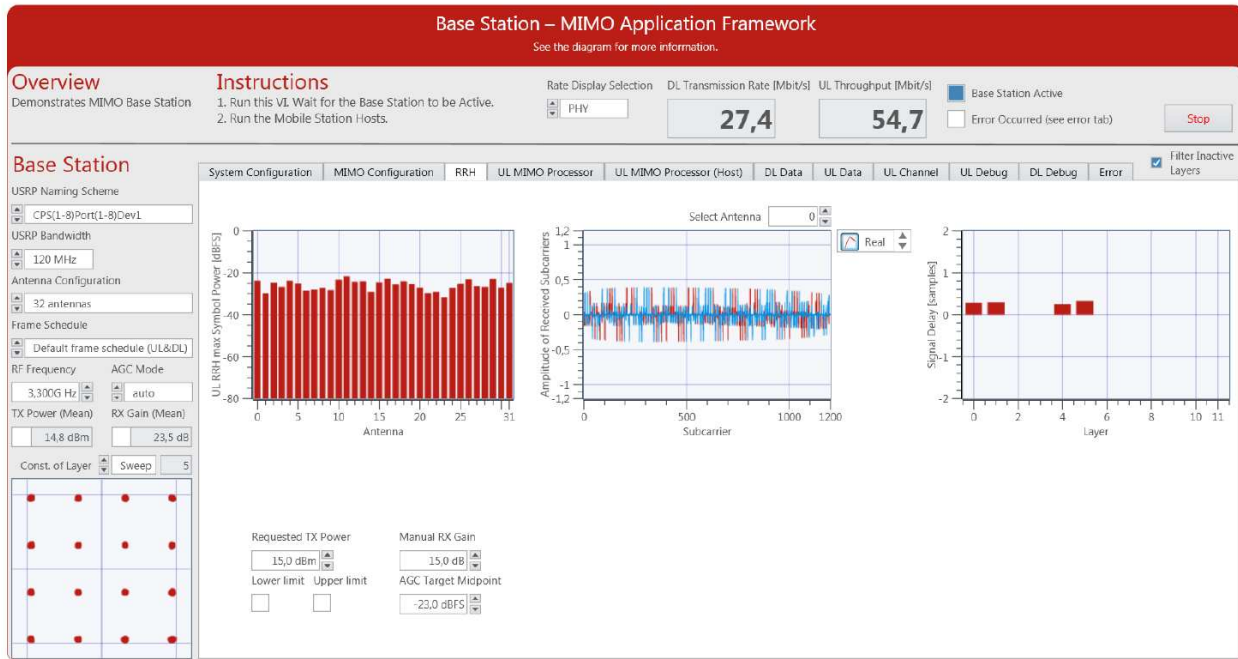

BS Controls and Indicators on UL MIMO Processor Tab

In this tab, the equalized subcarriers on the FPGA are presented. The following tables list the controls that are placed on the **UL MIMO Processor** tab of **Base Station Host.gvi** as shown in Figure 26.

Table 20. BS Host - Controls on UL MIMO Processor Tab

Control	Runtime	Description
OFDM Symbol to Capture (equalizer)	Yes	Shows the constellation of RX I/Q samples of the selected OFDM symbol number after equalization. The same OFDM symbol number is selected for all layers.

Table 21. BS Host - Indicators on UL MIMO Processor Tab

Indicator	Description
Equalized Subcarrier Layer 0 to Equalized Subcarrier Layer 11	Graphical representations that show the constellation of RX I/Q samples of all layers. If the number of active layers is less than 12, it is recommended to filter the inactive layers using the Filter Inactive Layers control located on the right side under the Stop button.

Figure 26. Front Panel of BS (UL MIMO Processor Tab)

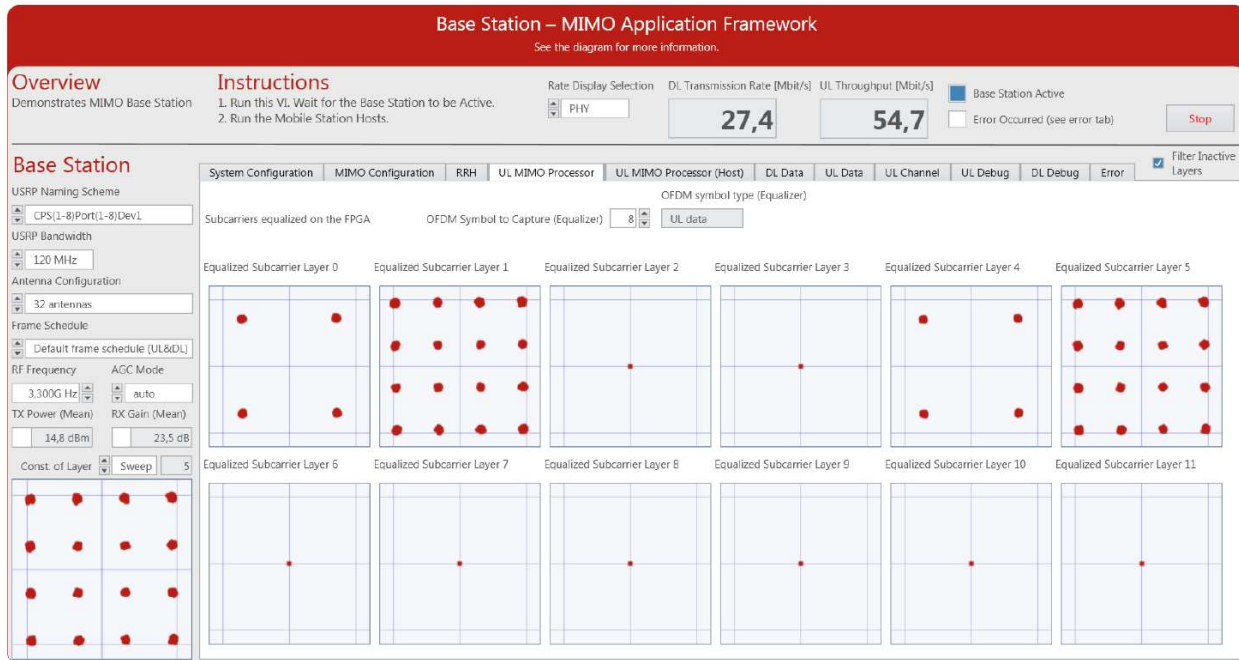

BS Indicators on UL MIMO Processor (Host) Tab

This tab contains the same graphical indicators as on the previous tab as shown in Figure 27. However, the channel estimation and equalization are performed on the host and not on the FPGA. The following tables show the corresponding numerical control and indicators, respectively.

Table 22. BS Host - Control on UL MIMO Processor (Host) Tab

Control	Runtime	Description
OFDM Symbol to Capture (RRH)	Yes	Selects the UL OFDM symbol index to apply the channel equalization and display the constellations.

Table 23. BS Host - Indicators on UL MIMO Processor (Host) Tab

Indicator	Description
Symbol index of Used UL Pilot	OFDM symbol index of the UL pilot to derive the channel estimation from.
Equalized Subcarrier Layer 0 (H) to Equalized Subcarrier Layer 11 (H)	Graphical representations that show the constellation of RX I/Q samples of all layers. If the number of active layers is less than 12, it is recommended to filter the inactive layers using the Filter Inactive Layers control located on the right side under the Stop button.

Figure 27. Front Panel of BS (UL MIMO Processor Tab (Host))

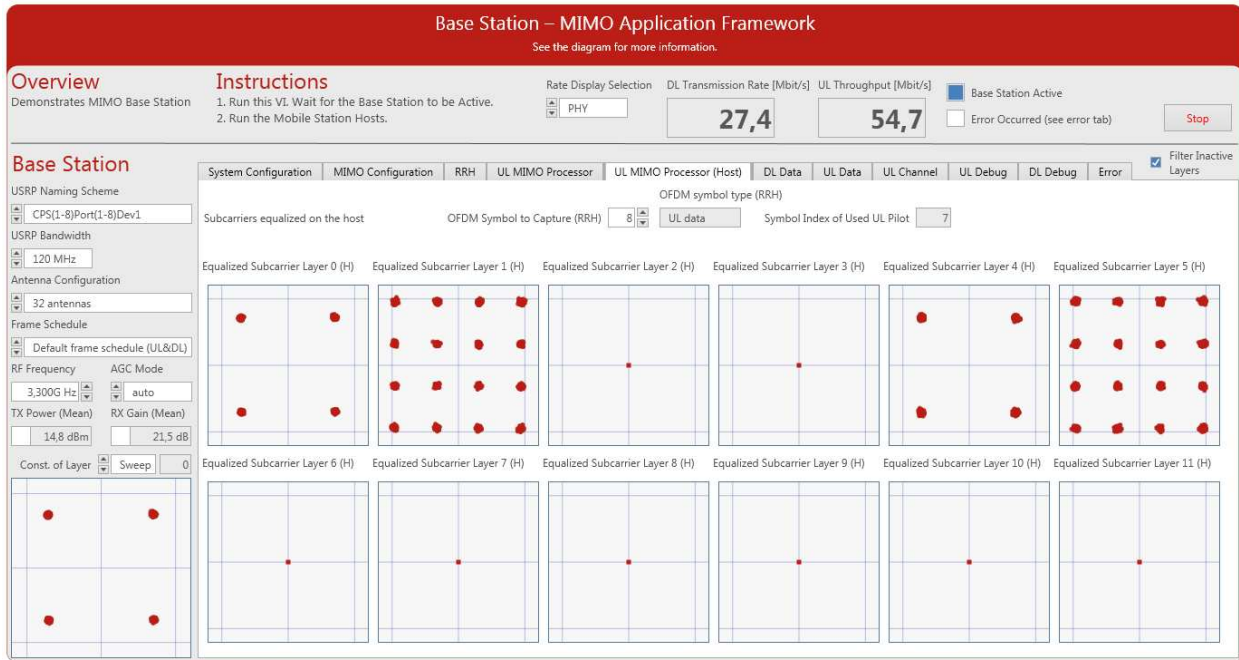

BS Indicators on DL Data Tab

The following table lists the indicators placed on the **DL Data** tab of **Base Station Host.gvi** as shown in Figure 28.

Table 24. BS Host - Indicators on DL Data Tab

Indicator	Description
DL Transmission Rate [Mbit/s]	Graphical indication showing the DL transmission rate of all layers in Mbit per second with respect to time.
DL Transmission Rate Per Layer [Mbit/s] Table	Numerical indication of the DL transmission rate of all layers in Mbit per second. The DL transmission rate of both PHY and MAC are presented.

Figure 28. Front Panel of BS (DL Data Tab)

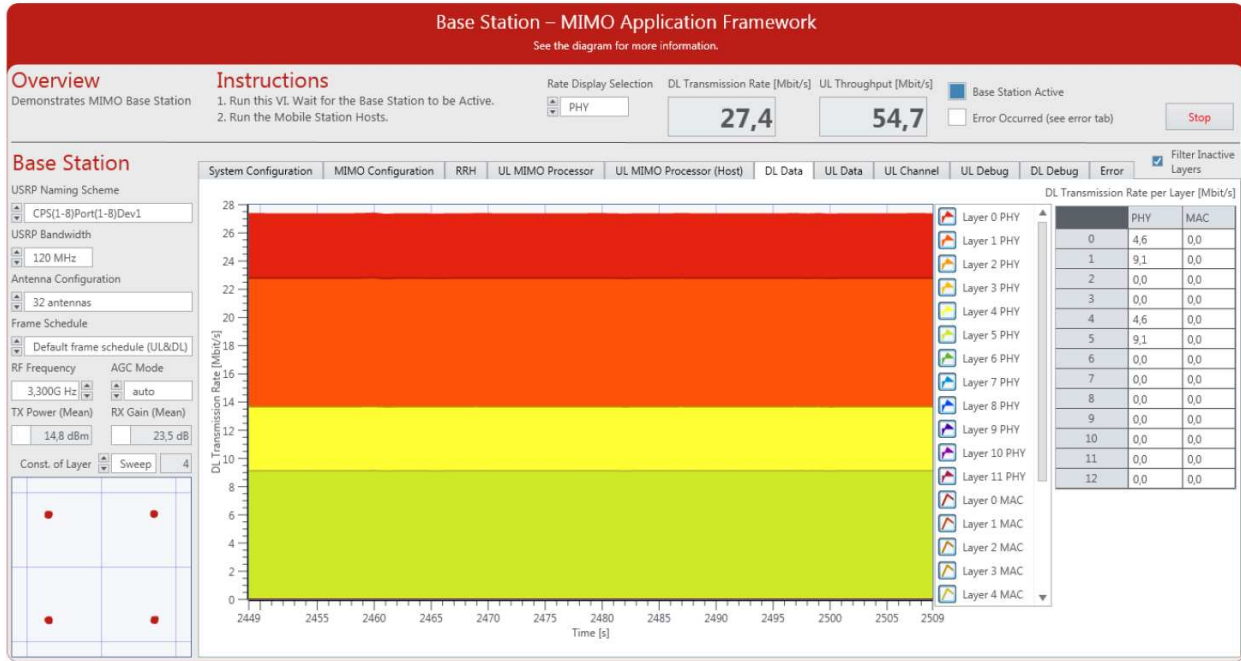

BS Indicators on UL Data Tab

The following table lists the indicators which are placed on the **UL Data** tab of **Base Station Host.gvi** as shown in Figure 29.

Table 25. BS Host - Indicators on UL Data Tab

Indicator	Description
UL Throughput [Mbit/s] Graph	Graphical indication showing the actual throughput of all layers in Mbit per second.
UL Throughput per Layer [Mbit/s] Table	Numerical indication of the actual throughput of all layers in Mbit per second in UL. The UL throughput of both PHY and MAC are presented for all layers. In addition, the BLER of all layers is presented.
BLER Graph	Graphical indicator showing the BLER of all layers.

Figure 29. Front Panel of BS (UL Data Tab)

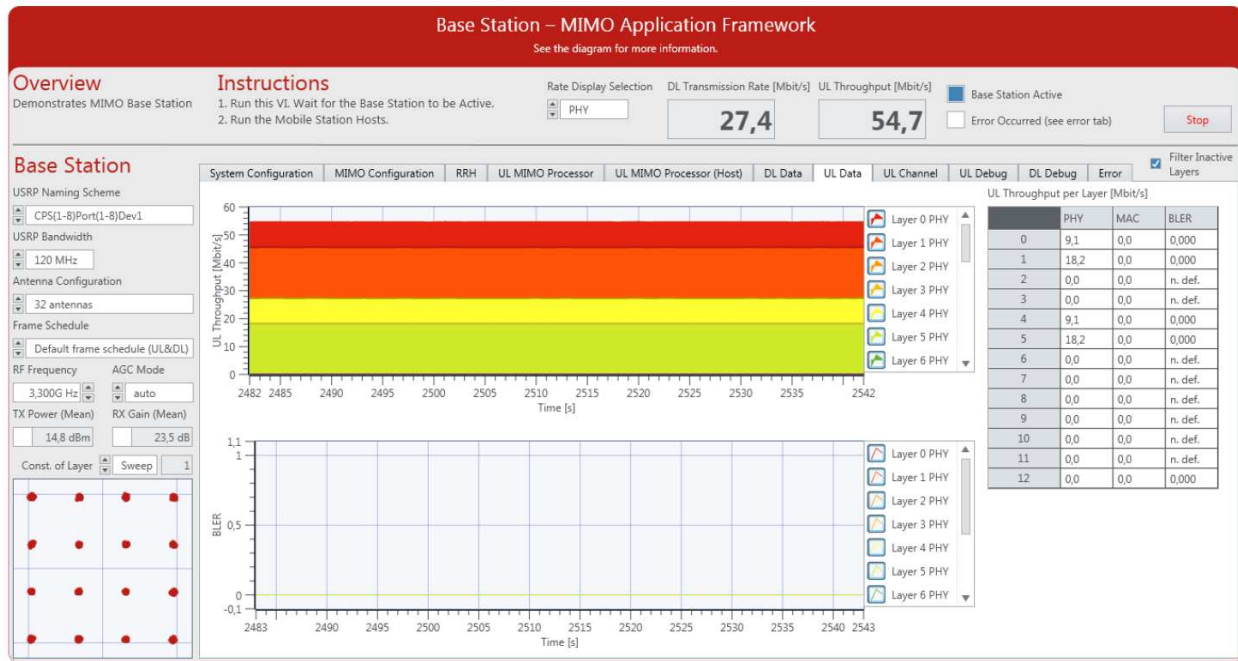

BS Indicators and Control on UL Channel Tab

The following tables list the control and indicators placed on the **UL Channel Host.gvi** as shown in Figure 30.

Table 26. BS Host - Control on UL Channel Tab

Control	Runtime	Description
Antenna Selection	Yes	Numerical control selects the BS antenna to calculate the Channel Frequency Responses, Channel Impulse Responses, and the Layers intensity.

Table 27. BS Host - Indicators on UL Channel Tab

Indicator	Description
Signal Strength [dBFS]	Graphical indication located on top-right side showing the received signal strength in dBFS for all layers versus all antennas of BS.
Channel Frequency Response [dBFS]	Graphical indication located on bottom-right showing the channel frequency responses in dBFS of all layers.
Channel Impulse Response [dBFS]	Graphical indication located on bottom-left showing the channel impulse responses of all layers. The amplitude of the channel impulse responses is in dBFS while the time delay is in terms of LTE samples.
Layers Graph	Graphical indication located on top-left side showing the channel impulse response in dBFS of all layers as an intensity figure.

Figure 30. Front Panel of BS (UL Channel Tab)

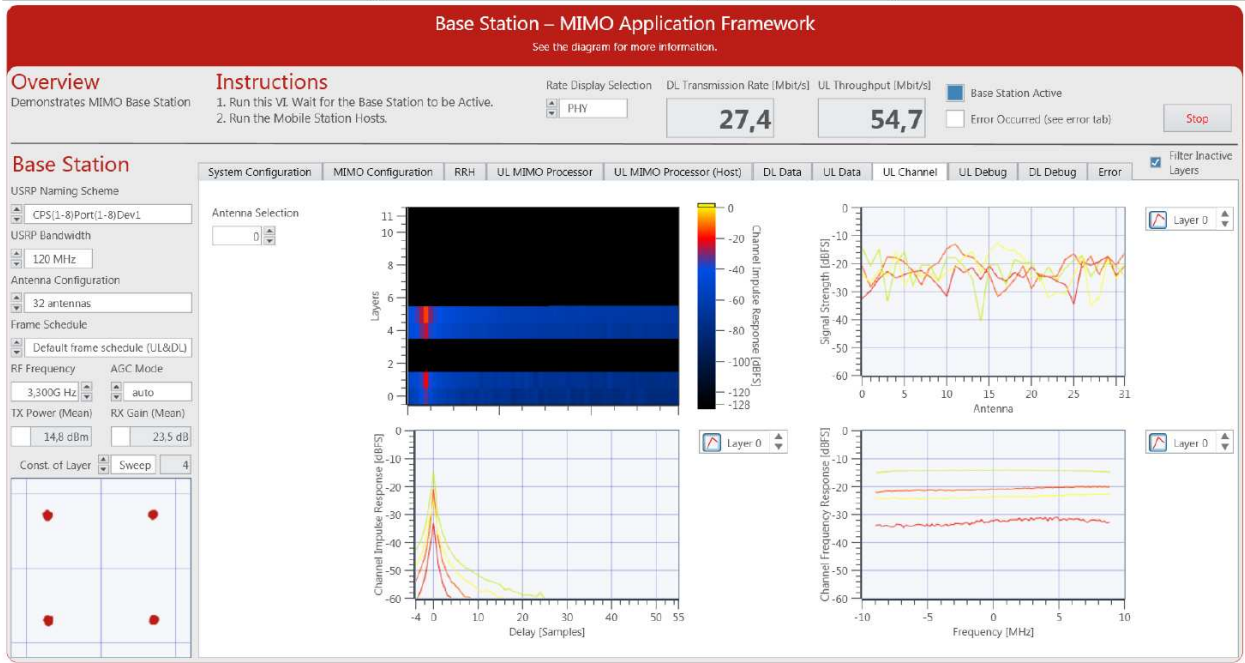

BS Control and Indicators on UL Debug Tab

Figure 31 shows the screenshot of the UL Debug tab of **Base Station Host.gvi**. This tab contains a block diagram of the UL part of the system overlaid with numeric and Boolean indicators which indicate the number of samples processed per second and fixed-point overflows. The control and indicators are listed in the following tables.

Table 28. BS Host - Control on UL Debug Tab

Control	Runtime	Description
RRH Subsystem (UL)	Yes	Numerical control selects the subsystem number based on the MIMO system configuration. The maximum number of subsystems is 8, hence the control ranges from 0 to 7.

Table 29. BS Host - Indicators on UL Debug Tab

Indicator	Description
For RRH 0 to RRH 7	
RX Samples	Numerical indicator displaying the number of RX samples in the time domain processed per second. Because the LTE sampling frequency is 30.72 MHz, the values should equal 3.072×10^7 . ¹⁴

¹⁴ Each RRH provides 2 antennas for the BS.

Indicator	Description
RX Overflows	Numerical indicator that shows overflows in the first-in-first out memory buffer (FIFO) that connects the USRP RX loop, which reads from the ADC and performs digital down-conversion, and the RX I/Q processing loop, which performs OFDM demodulation. Overflows can occur when the samples are not processed fast enough either in the RX I/Q processing chain or on the MIMO Processors. Another possibility is too high traffic on the PCI-Express bus which stalls the P2P streams. The values should be 0 if the system is in normal operation. ¹⁴
Fixed-point overflow	Boolean indicator that shows fixed-point overflows in the I/Q processing chain. The TX power levels and RX gains should be configured so that no fixed-point overflows occur.
RRH Router 0	Number of samples processed per second by RRH Router 0. For RRH 0 (RRH Combiner), the number should be 1.26×10^7 multiplied by the number of RRHs in the subsystem.
For MIMO Processor 0 to MIMO Processor 3	
Router 0 and Router 1	Numeric indicators displaying the number of samples processed by router 0 and router 1 per second. The value should be 1.008×10^8 .
Bit Processor	
Router 0	Numeric indicator displaying the number of samples processed by router 0 per second. The value depends on the selected frame schedule.
Overflows in RX Chain	
RRH USRP RX Overflow	Indicates that an overflow occurred on the RRH between RF and baseband clock domain.
MIMO Processor Local FIFO Overflow	Indicates that an overflow occurred on the MIMO processor when forwarding RX data to the bit processor.
Bit Processor Data FIFO Overflow	Indicates that an overflow occurred on the bit processor when writing RX data to host.
DTP Processor FIFO Underflow	Indicates that an underflow occurred during the payload and packet information collection of the data transfer protocol (DTP) payload in a FIFO in the bit processor. This Boolean indicator is true if there is data underflow in any layer's DTP payload that is collected in a Round-Robin.
DTP Processor FIFO Overflow	Indicates that an overflow occurred during the payload and packet information collection of the DTP payload in a FIFO in the bit processor. This Boolean indicator is true if there is data overflow in any layer's DTP payload that is collected in a Round-Robin.

Figure 31. Front Panel of BS (UL Debug Tab)

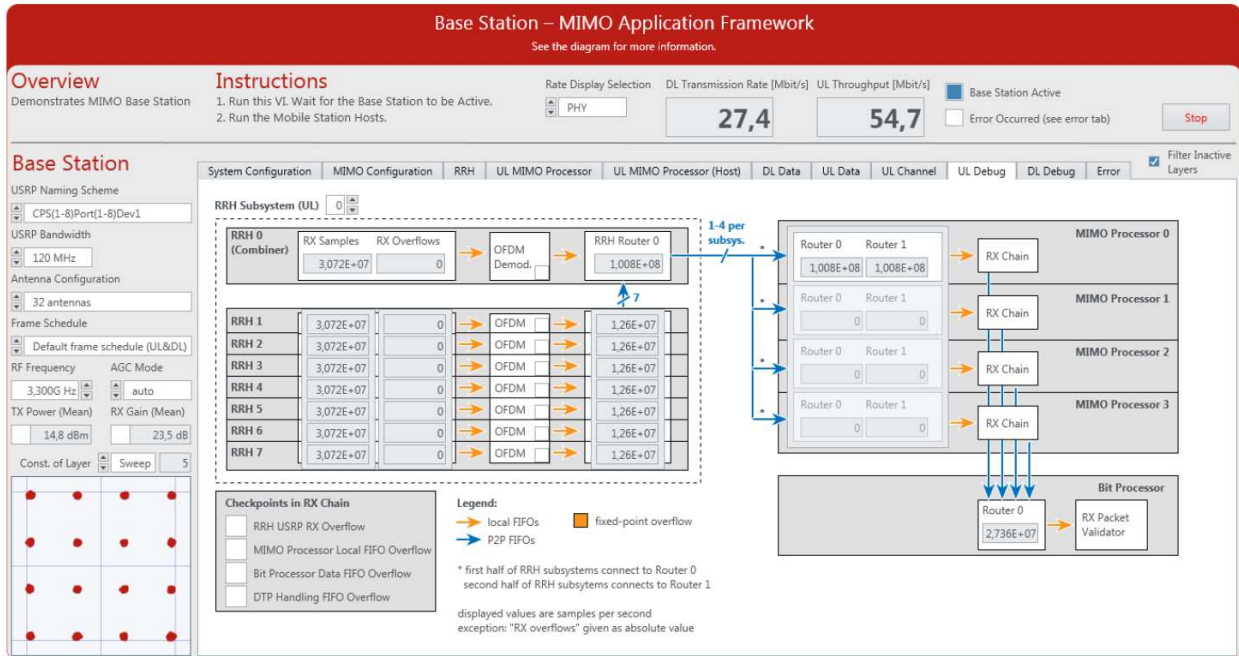

BS Control and Indicators on DL Debug Tab

Figure 32 shows the screenshot of the DL Debug tab of **Base Station Host.gvi**. This tab contains a block diagram of the DL part of the system overlaid with numeric and Boolean indicators which indicate the number of samples processed per second and fixed-point overflows. The control and indicators are listed in the following tables.

Table 30. BS Host - Control on DL Debug Tab

Control	Runtime	Description
RRH Subsystem (DL)	Yes	Numerical control selects the subsystem number based on the MIMO system configuration. The maximum number of subsystems per MIMO system is 8, hence the control ranges from 0 to 7.

Table 31. BS Host - Indicators on DL Debug Tab

Indicator	Description
Bit processor	
Router 1	Numeric indicator displaying the number of samples processed by router 1 per second. The value depends on the selected frame schedule.
For MIMO Processor 0 to MIMO Processor 3	
Fixed-point overflow	Boolean indicator that indicates fixed-point overflows in the TX chain.
Router 2 and Router 3	Numeric indicators displaying the number of samples processed by router 2 and router 3 per second. The value should be 1.008×10^8 .
For RRH 0 to RRH 7	

Indicator	Description
Bit processor	
RRH Router 1	Number of samples processed per second by RRH Router 1. For the last RRH in a subsystem (RRH Splitter), the number should be 1.26×10^7 multiplied by the number of RRHs in the subsystem.
Fixed-point overflow	Boolean indicator that indicates fixed-point overflows in the OFDM modulation.
TX Samples	Numerical indicator displaying the number of TX samples in the time domain processed per second. Because the LTE sampling frequency is 30.72 MHz, the values should equal 3.072×10^7 .
TX Underflows	Numerical indicator that indicates underflows in the FIFO between baseband and RF processing on each RRH. Underflows can occur when the samples are not processed fast enough either on the MIMO Processors or in the TX I/Q processing chain. Another possibility is that the traffic is too high on the PCI-Express bus which stalls the P2P streams. The values should be zero if the system is in normal operation.
RRH USRP TX Underflow	Boolean indicator that indicates underflows in the FIFO between baseband and RF processing on each RRH. Look to the numerical indicator TX Underflows above.

Figure 32. Front Panel of BS (DL Debug Tab)

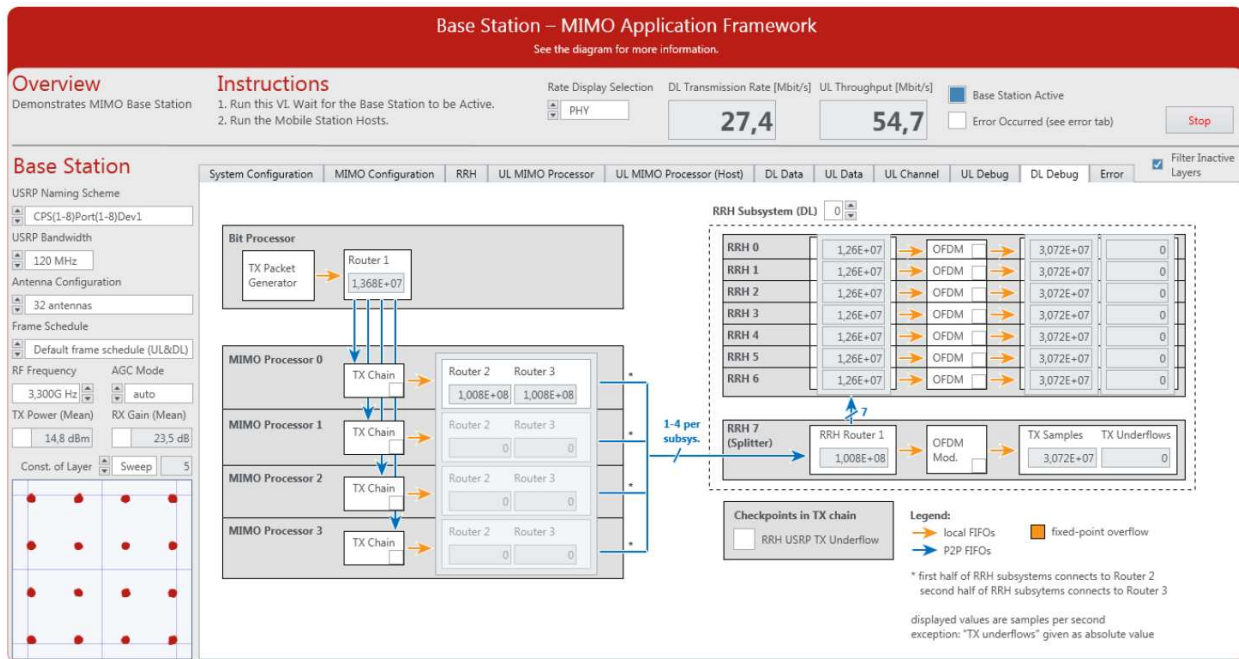

BS Indicators on Error Tab

Figure 33 shows the screenshot of the Error tab of **Base Station Host.gvi**. The indicators on this tab are listed in the following table. The values are updated when the system stops, for example, upon receiving an error during initialization.

Table 32. BS Host – Indicators on Error Tab

Indicator	Description
Error	Displays the resulting error cluster.
Error Report	Displays resulting error as error report.
Timing Module Initialization	Indicates if an error occurred during initialization of the timing module and, if yes, displays the hardware alias of the timing module.
MIMO Processor Initialization	Indicates if an error occurred during initialization of the MIMO processors and, if yes, displays the hardware alias of the first failing element.
Bit Processor Initialization	Indicates if an error occurred during initialization of the bit processor.
RRH Initialization	Indicates if an error occurred during initialization of the RRHs and, if yes, displays the hardware alias of the first failing element.

Figure 33. Front Panel of BS (Error Tab)

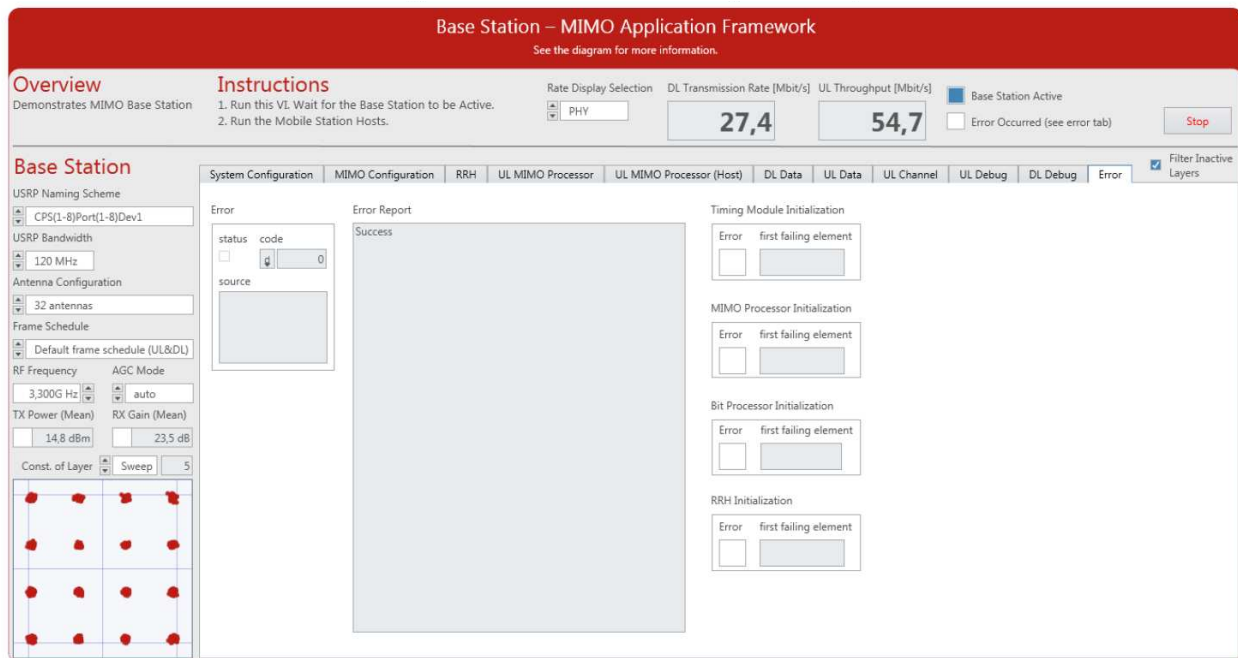

Description of Controls and Indicators on the Single Antenna MS Host Front Panel

This section describes all controls and indicators that are placed on the front panel of **Single Antenna Mobile Station Host.gvi**.

Single Antenna MS Basic Configurations

Several controls and indicators are placed outside the main tab control of **Single Antenna Mobile Station Host.gvi** as shown in Figure 20, *Front Panel of Single Antenna MS (Configuration Tab)*. The following tables list the corresponding controls and indicators.

Table 33. Single Antenna MS – Main Panel Controls

Control	Runtime	Description
RIO Device	No	Configures the RIO identifier of the RIO device . Use MAX to get or modify the RIO identifiers of your devices. You can also launch Hardware tab, where LabVIEW Communications System Design Suite has an integrated hardware manager. This control should be configured before running MS.
USRP Bandwidth	No	Determines the BW of the used USRP devices. The enumeration contains the following values: <ul style="list-style-type: none"> • 160 MHz • 120 MHz • 40 MHz
Sync Mode	No	Selects the MS Synchronization Mode: <ul style="list-style-type: none"> • Over-the-air by using synchronization signal. • Using external trigger provided by the BS through the PPS trigger port.
Frame Schedule	No	Determines the frame schedule to use.
RF Frequency	No	Selects a frequency supported by your USRP device as the RF Frequency. ¹⁵
TX Delay	Yes	Used to adjust the time delay manually in RF clock cycles of the USRP device. It should be used with the Signal Delay [Samples] figure placed on RRH tab of the BS front panel.
MS 0 Layer	Yes	Selects the MS layer identity from the set {0, ..., 11}. ¹⁶ Selects the MS layer identity to off to deactivate the MS 0.
MS 1 Layer	Yes	Selects the MS layer identity from the set {0, ..., 11}. ¹⁶ Selects the MS layer identity to off to deactivate the MS 1.
Rate Display Selection	Yes	Selects the MS rate of DL Throughput [Mbit/s] and UL Transmission Rate [Mbit/s] indicators: <ul style="list-style-type: none"> • PHY: Shows the packet data rate. • MAC: Shows the payload throughput. <p>If the UL Data Source and DL Data Sink controls under System Configuration tab are set to UDP without running the video streaming, the displayed UL Transmission Rate and DL Throughput are zeros if the Rate Display Selection is set to MAC.</p>

Table 34. Single Antenna MS – Indicators on Basic Configurations

Indicator	Description
Mobile Stations Ready	If the system started up successfully, it lights.
Error Occurred (see Error tab)	A Boolean indicator that shows whether an error occurred during initialization.
UL Transmission Rate [Mbit/s]	Numerical display showing the UL transmission rate in Mbit/s for MS 0 and MS 1.

¹⁵ Consider local laws if you are transmitting over-the-air. USRP and USRP RIO devices are not approved or licensed for transmission over-the-air using an antenna.

¹⁶ Each MS should be given a different identity. Otherwise they will receive the same data from the BS.

Indicator	Description
DL Throughput [Mbit/s]	Numerical display showing the DL throughput in Mbit/s for MS 0 and MS 1.

Single Antenna MS System Configuration Tab

The following tables list the controls and indicators, respectively, which are placed on the System Configuration tab of **Single Antenna Mobile Station Host.gvi** as shown in Figure 20, *Front Panel of Single Antenna MS (Configuration Tab)*.

Table 35. Single Antenna MS – Controls on System Configuration Tab

Control	Runtime	Description
UL Synchronization Source	Yes	Used to select the UL transmission synchronization source if the Sync Mode control is over-the-air. It can be automatic or MS 0 or MS 1.
PN Data Packet Size	Yes	Size of packets in PN data transmission mode. There will be always the same packet transmitted over all configured layers.
PN Packets per Seconds	Yes	Number of packets transmitted in PN mode per seconds.
UL Data Source	Yes	<ul style="list-style-type: none"> • Off: No data is transmitted in UL • UDP: Received UDP packets are transmitted with the corresponding MS in UL. • PN Data: A random packet is transmitted at PN packets per second rate on all active MSs.
Initial UL Data UDP Port	No	This UDP port address and the subsequent one are opened for UDP packet reception for both MSs. The default UDP UL Data Port is 50.000.
DL Data Remote Address	Yes	The IP address that the UDP packets received from BS are sent to.
DL Data Sink	Yes	If it is set to UDP, received frames are forwarded to the configured UDP address and port.
Initial DL Data UDP Port	No	This UDP port address and the subsequent one are opened for UDP packet transmission of both MSs. The default UDP DL Data Port is 51.000.

Table 36: Single Antenna MS – Indicators on Configuration Tab

Indicator	Description
Frame Schedule Table	Shows the OFDM Frame Schedule of all 12 layers. The OFDM symbol types of each MS frame (140 OFDM Symbols) are presented. The OFDM symbol type could be Guard, Sync, DL pilot, DL data, UL pilot, and UL data. In addition, the modulation schemes of all layers are presented, which could be QPSK, 16-QAM, 64-QAM, and 256-QAM. The Frame Schedule Table indicator is controlled by Frame Schedule control.
UL Data UDP Ports	Shows the value of UDP ports to forward traffic to the BS.
DL Data UDP Ports	Shows the value of UDP ports to forward traffic from the BS.

Single Antenna MS Controls and Indicators on AGC / TPC & Synchronization Tab

The following tables show the MS controls and indicators that occur on **AGC/Synchronization** tab as shown in Figure 34.

Table 37. Single Antenna MS – Controls on AGC/TPC & Synchronization Tab

Control	Runtime	Description
RX Gain - AGC	Yes	Sets the required parameters of AGC in the RX chain. It has three sets of controls and indicators: <ul style="list-style-type: none"> • AGC Settings • Manual Settings • Status
AGC Settings	Yes	Sets the required parameters of RX AGC.
AGC Mode	Yes	Switch between automatic and manual gain control
Manual Settings	Yes	Sets the required parameters of manual AGC mode.
RX Gain (manual)	Yes	Sets the RF RX gain in dB of both MSs in manual mode.
TX Power - TPC	Yes	Sets the required parameters of transmission power control (TPC) in the TX chain. It has three sets of controls and indicators: <ul style="list-style-type: none"> • TPC Settings • Manual Settings • Status
TPC Settings / TPC Mode	Yes	Switch between automatic and manual transmit power control.
TPC Settings / Base Station Configuration		The values of the BS configuration must match the settings on the BS.
RX Gain	Yes	Sets the value similar to that of BS RF RX gain in dB.
Active Layers	Yes	Sets the overall number of active UL layers in the system.
TX Power	Yes	Sets the value similar to that of BS RF TX power in dBm.
Antennas	Yes	Sets the number of antenna at the BS.
Manual Settings - TX Power	Yes	Sets the RF TX power in dBm for both MSs in case of manual mode.

Table 38. Single Antenna MS – Indicators on AGC/TPC & Synchronization Tab

Indicator	Description
RX Gain – AGC / Status	Shows the status of the RX AGC.
Coerced RX Gain	The actual used analog RX RF gain in dB for both MSs.
Max Symbol Power	Shows the maximum power in dBFS from the received OFDM symbols for both MSs.
PSS Symbol Power	Shows the power of the received PSS synchronization signal for both MSs.
TX Power – TPC Status	Shows the status of the Transmit Power control.
Coerced TX Power	Indicates the coerced value that is actually used as a maximum RF TX output power in dBm for both MSs after applying the device capabilities (range and resolution limitations) to the configured value.

Indicator	Description
Lower and Upper Limit	Boolean indicators corresponding to the Coerced TX Power indicator. They show whether the configured value of TX Power is coerced to the allowed range.
Frame Timing Estimation [Samples]	Graphical indication showing the timing estimation of the radio frame.
Signal Detected	Graphical indication showing whether each of the MSs can detect the synchronization signal successfully. The graph is updated every one second.
Sync Loss Counter	Counts how often the sync was lost since starting the node. The value of the Sync Loss Counter is read from the FPGA while the Signal Detected figure is updated every one second. Hence, if the synchronization is lost sometimes, the Sync Loss Counter will show that while the Signal Detected figure cannot show that.
CFO [Hz]	Graphical indication showing the carrier frequency offset (CFO) in Hz of both MSs.

Figure 34. Front Panel of Single Antenna MS (AGC/TPC & Synchronization Tab)

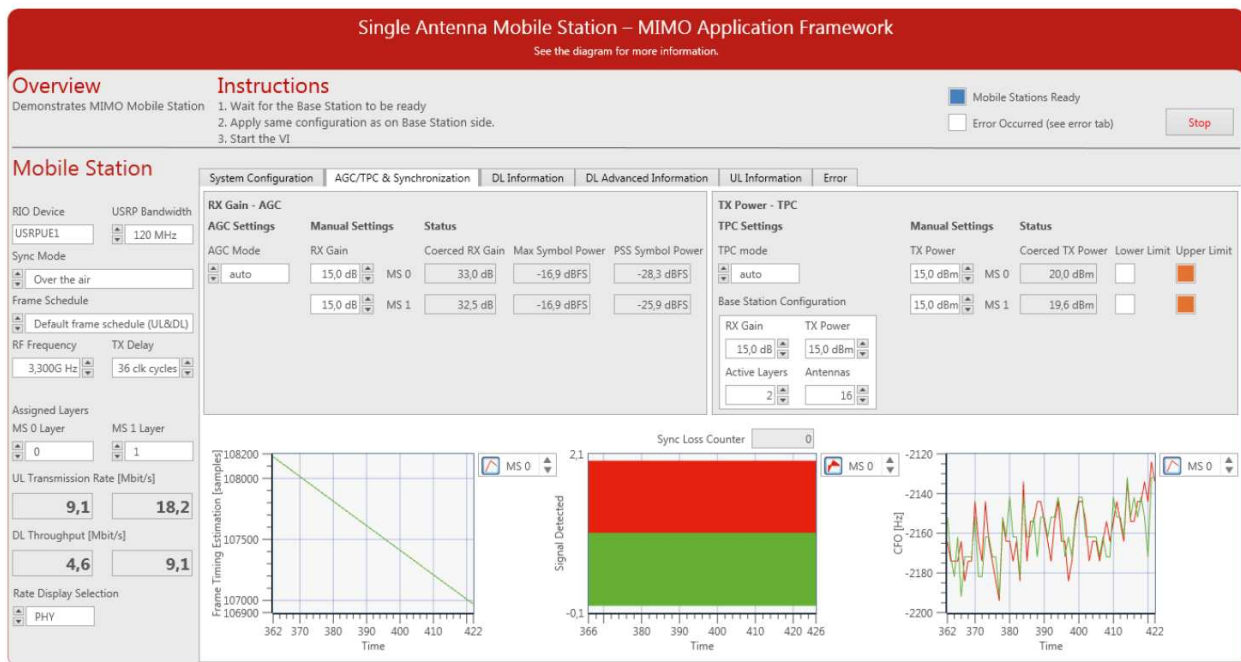

Single Antenna MS Control and Indicators on DL Information Tab

From Figure 35, the control and indicators on the DL Information tab of MS are presented in the following table.

Table 39. Single Antenna MS –Indicators on DL Information Tab

Parameter	Description
RX Power MS 0 [dB]	Indicates the power spectrum of the DL RX baseband signal received from the RF of MS 0.

Parameter	Description
RX Power MS 1 [dB]	Indicates the power spectrum of the DL RX baseband signal received from the RF of MS 1.
DL Throughput MS 0 [Mbit/s]	Graphical indication showing the DL throughput of MS 0 in Mbit/s.
DL PHY MS 0	Numerical display showing the PHY throughput of MS 0 in Mbit/s.
DL MAC MS 0	Numerical display showing the MAC throughput of MS 0 in Mbit/s.
DL Throughput MS 1 [Mbit/s]	Graphical indication showing the DL throughput of MS 1 in Mbit/s.
DL PHY MS 1	Numerical display showing the PHY throughput of MS 1 in Mbit/s.
DL MAC MS 1	Numerical display showing the MAC throughput of MS 1 in Mbit/s.
BLER MS 0	Graphical and numerical indicator showing the BLER of MS 0.
BLER MS 1	Graphical and numerical indicator showing the BLER of MS 1.

Figure 35. Front Panel of Single Antenna MS (DL Information Tab)

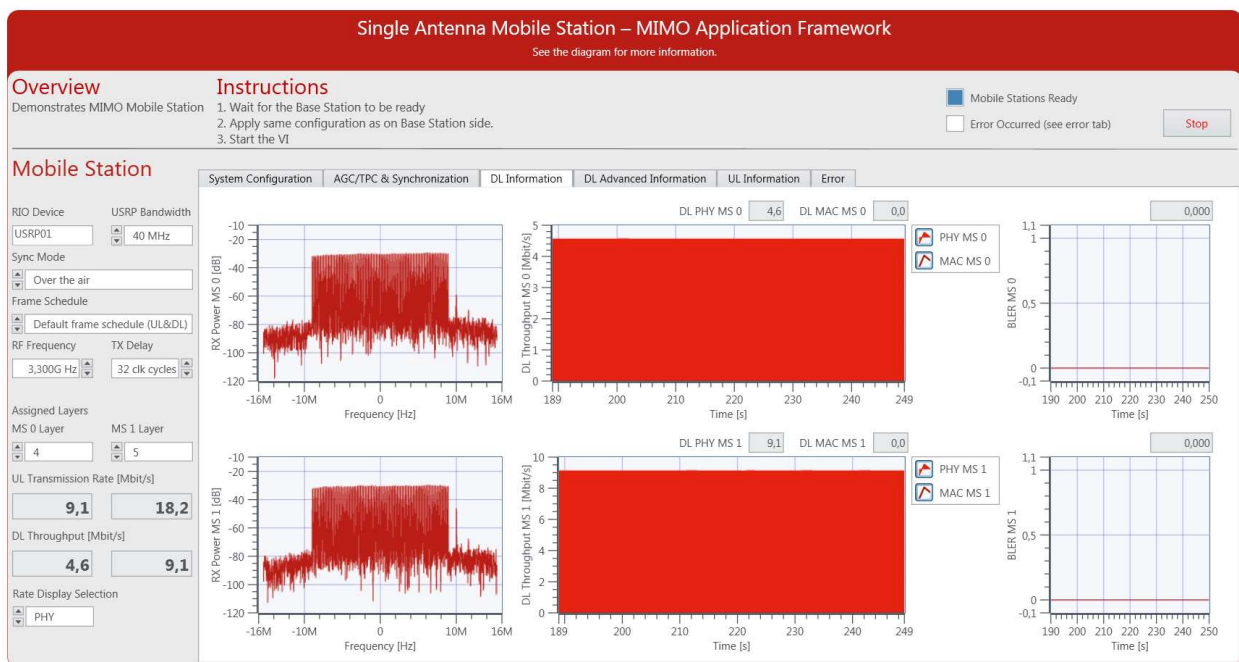

Single Antenna MS Indicators on DL Advanced Information Tab

From Figure 36, the indicators on the DL Advanced Information tab of MS are presented in the following table.

Table 40. Single Antenna MS – Indicators on DL Advanced Information Tab

Indicator	Description
Debug FIFOs	Numerical indicators are used to show how many overflows occurred.
RX Channel Estimation MS 0 Overflow	Overflow counters for the respective target to host FIFO.
RX Channel Estimation MS 1 Overflow	
RX Const MS 0 Overflow	

Indicator	Description
RX Const MS 1 Overflow	
USRP RX Chain Status	Numerical and Boolean indicators are used to signal misbehavior within the RX chain.
RX IQ Signal Clipped MS 0	Shows if the RX I/Q signal is clipped due to bad level control.
RX IQ Signal Clipped MS 1	Shows if the RX I/Q signal is clipped due to bad level control.
RX Number of Overflows	Number of overflows in RX before baseband processing.
RX Overflow	Indicates the RX Number of Overflows value if it is different from zero.
DTP Handling FIFO Overflow MS 0	Overflow in DTP FIFOs for the respective MS.
DTP Handling FIFO Overflow MS 1	Overflow in DTP FIFOs for the respective MS.
RX Constellation MS 0	Constellation of RX I/Q samples of MS 0 after equalization. The OFDM symbol to display is changed after each update in a Round-Robin fashion.
RX Constellation MS 1	Constellation of RX I/Q samples of MS 1 after equalization. The OFDM symbol to display is changed after each update in a Round-Robin fashion.
Channel Frequency Response MS 0 [dB]	Graphical representation of the channel amplitude in dB and phase estimated using the pilots.
Channel Frequency Response MS 1 [dB]	Graphical representation of the channel amplitude in dB and phase estimated using the pilots.
SNR (dB) MS 0 and SNR (dB) MS 1	Numerical indicators show the measured SNR (dB) of MS 0 and MS 1.
EVM (%) MS 0 and EVM (%) MS 1	Numerical indicators show the measured EVM defined as a percentage of MS 0 and MS 1. The earned value of EVM indicates to the quality of measurements. A small value of EVM (%) leads to a small BLER.

Figure 36. Front Panel of Single Antenna MS (DL Advanced Information Tab)

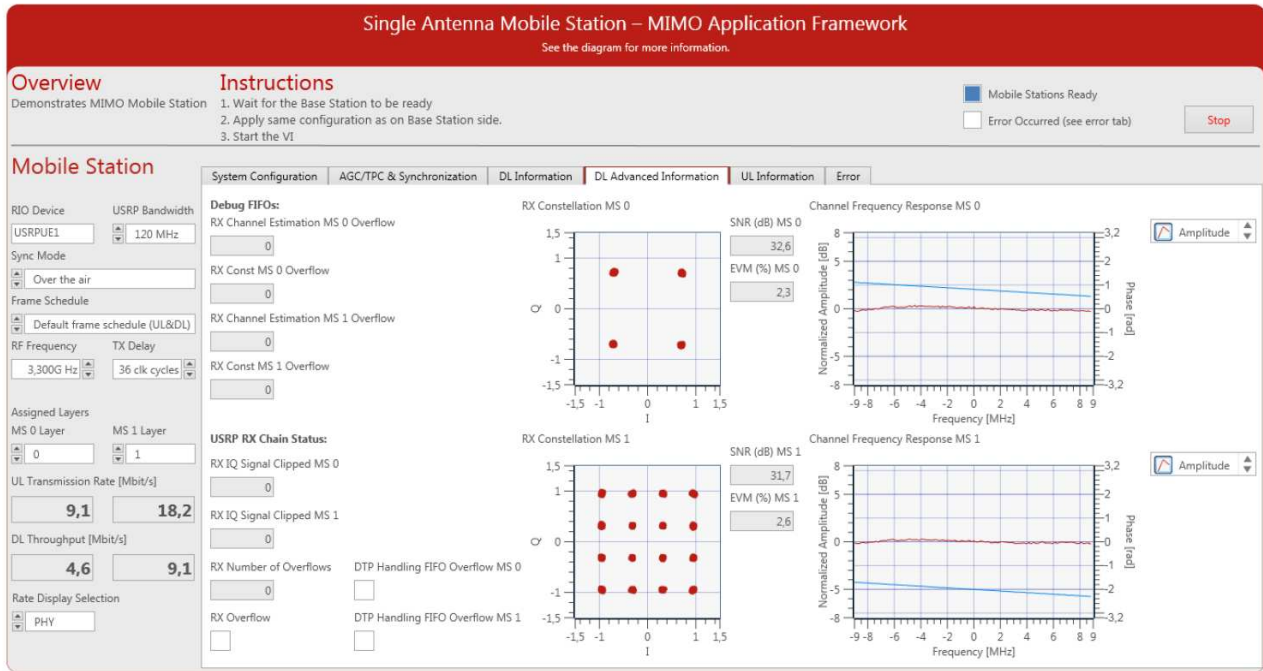

Single Antenna MS Indicators on UL Information Tab

From Figure 37, the indicators on the UL Information tab of the MS are presented in the following table.

Table 43. Single Antenna MS – Indicators on UL Information Tab

Indicator	Description
IFFT Output Clipped MS 0	Indicates a numeric overflow after the inverse Fast Fourier Transform (IFFT) of MS 0.
TX Power Spectrum MS 0 [dB]	Indicates the power spectrum in dB of the UL TX baseband signal transferred to the RF of MS 0.
IFFT Output Clipped MS 1	Indicates a numeric overflow after the IFFT of MS 1.
TX Power Spectrum MS 1 [dB]	Indicates the power spectrum in dB of the UL TX baseband signal transferred to the RF of MS 1.
UL PHY MS 0 and UL MAC MS 0	Numerical displays showing the PHY and MAC UL transmission rate in Mbit/s for MS 0.
UL Transmission Rate MS 0 [Mbit/s]	Graphical indication showing the UL transmission rate in Mbit/s of MS 0.
UL PHY MS 1 and UL MAC MS 1	Numerical displays showing the PHY and MAC UL transmission rate in Mbit/s for MS 1.
UL Transmission Rate MS 1 [Mbit/s]	Graphical indication showing the UL transmission rate in Mbit/s of MS 1.

Figure 37. Front Panel of Single Antenna MS (UL Information Tab)

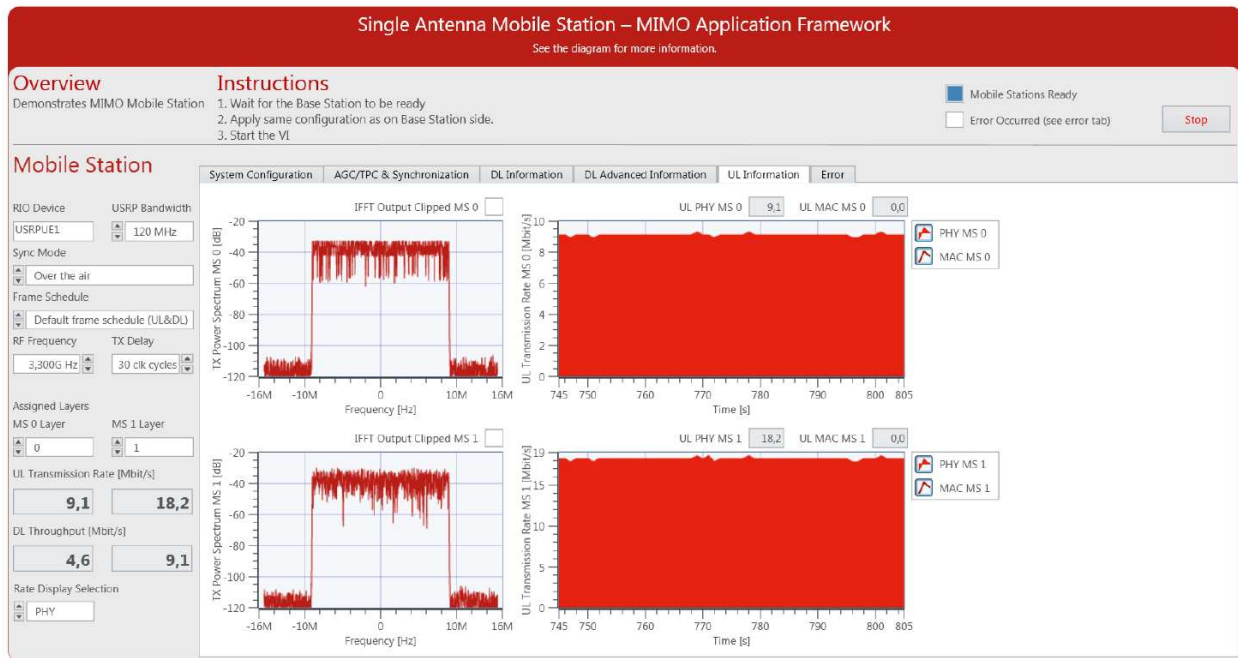

Single Antenna MS Indicators on Error Tab

Figure 38 shows the screenshot of the Error tab of **Single Antenna Mobile Station Host.gvi**. The indicators on this tab are listed in the following table. The values are updated when the system stops, for example, upon receiving an error during initialization.

Table 44. Single Antenna MS - Indicators on Error Tab

Indicator	Description
Error	Displays the resulting error cluster.
Error Report	Displays resulting error as error report.

Figure 38. Front Panel of Single Antenna MS (Error Tab)

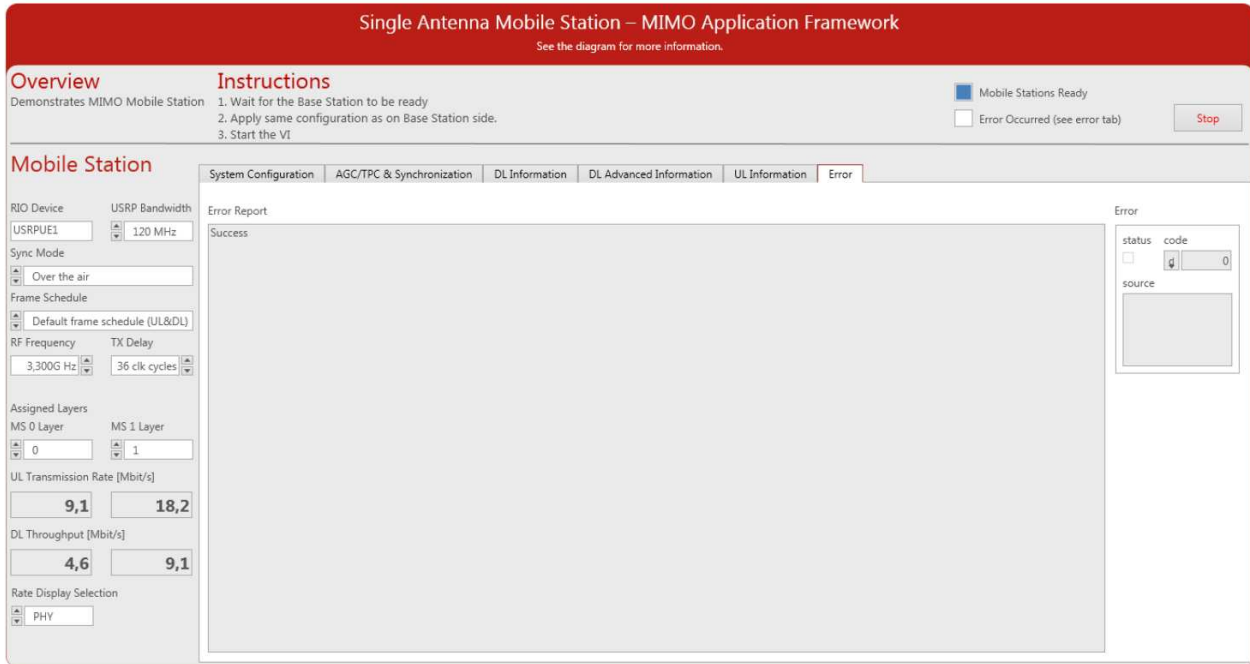

Description of Controls and Indicators on the Multi-Antenna MS Host Front Panel

This section describes all controls and indicators which are placed on the front panel of **Multi Antenna Mobile Station Host.gvi**. Most of the controls and indicators are similar to that of the BS.

Multi-Antenna MS Basic Controls and Indicators

Several controls and indicators are placed outside the main tab control of **Multi Antenna Mobile Station Host.gvi** as shown in Figure 21, *Front Panel of Multi-Antenna MS (MIMO Configuration Tab)*. The following tables list the presented controls and indicators, respectively.

Table 45. Multi-Antenna MS Host – Main Panel Controls

Control	Runtime	Description
USRP Naming Scheme	No	Determines the naming scheme of the USRP devices which are loaded with the RRH bitfiles. The enumeration contains the following values: <ul style="list-style-type: none"> • CPS(1-8)Port(1-8)Dev1 • PXI(2-5)Slot(2-18)Port1Dev1 • USRP(01-64)
USRP Bandwidth	No	Determines the BW of the used USRP devices. The enumeration contains the following values: <ul style="list-style-type: none"> • 160 MHz • 120 MHz • 40 MHz
TX Delay	Yes	Used to adjust the time delay manually in RF clock cycles of the RRHs. It should be used with the Signal Delay [Samples] figure placed on RRH tab of the BS front panel. By continuously adjusting

Control	Runtime	Description
		the TX Delay , the estimated Signal Delay of all layers at the BS side should be around zero.
Antenna Configuration	No	Determines the number of antennas in the system. It should be even number up to 12.
Sync Mode	No	Selects the MS Synchronization Mode: <ul style="list-style-type: none"> • Over-the-air by using synchronization signal. • Using external trigger provided by the BS through PPS trigger port.
Frame Schedule	No	Determines the frame schedule to use.
RF Frequency	No	The center frequency for radio transmission and reception.
Const. of Layer	Yes	Selects the layer identity for the constellation plot below. Set to sweep to sweep through the layers over time.
Rate Display Selection	Yes	Selects the displaying rate type of UL Transmission Rate [Mbit/s] and DL Throughput [Mbit/s] indicators: <ul style="list-style-type: none"> • PHY: Shows the packet data rate. • MAC: Shows the payload throughput. If the UL Data Source and DL Data Sink controls under System Configuration tab are set to UDP without running the video streaming, the displayed UL Transmission Rate and DL Throughput are zeros if the Rate Display Selection is set to MAC.

Table 46. Multi-Antenna MS Host – Main Panel Indicators and Graphs

Indicator	Description
Equalized Subcarriers	Shows the constellations of the selected layer using Const. of Layer control or of all layers in sweep.
UL Transmission Rate [MBit/s]	Numerical display showing the total UL transmission rate in Mbit/s.
DL Throughput [MBit/s]	Numerical display showing the total DL throughput in Mbit/s.
Mobile Station Active	Boolean indicator that lights up if the MS is ready.
Error Occurred (see error tab)	Boolean indicator that lights up if an error occurred.

Multi-Antenna MS Indicators on System Configuration Tab

The following tables list the controls and indicators placed on the System **Configuration** tab of **Multi Antenna Mobile Station Host.gvi** as shown in Figure 39.

Table 47. Multi-Antenna MS Host – Controls on System Configuration Tab

Control	Runtime	Description
PN Data Packet Size	Yes	Size of packets in PN data transmission mode. There will be always the same packet transmitted over all configured layers.
PN Packets per Seconds	Yes	Number of packets transmitted in PN mode per seconds.

Control	Runtime	Description
UL Data Source	Yes	It has three options: <ul style="list-style-type: none"> • Off: No data is transmitted in UL. • UDP: Received UDP packets are transmitted with the corresponding MS in UL. • PN Data: A random packet is transmitted at PN packets per second rate on all active MSs.
UL Data UDP Port	No	This UDP port address is opened for UDP packet reception. The default UDP UL Data Port is 50.000.
DL Data Remote Address	Yes	The IP address that the UDP packets received from BS are sent to.
DL Data Sink	Yes	If it is set to UDP, received frames are forwarded to the configured UDP address and port.
DL Data UDP Port	No	This UDP port address is opened for UDP packet transmission. The default UDP DL Data Port is 51.000.

Table 48. Multi-Antenna MS Host - Indicators on System Configuration Tab

Indicator	Description
RRHs	Shows the RIO aliases of active USRP devices per subsystem.
MIMO Processor	Shows the addresses of active FlexRIO modules for I/Q Processing.
Bit Processor	Shows the address of active FlexRIO module for bit processing.
Timing Module	Shows the address of Timing Module RIO card.

Figure 39. Front Panel of Multi-Antenna MS (System Configuration Tab)

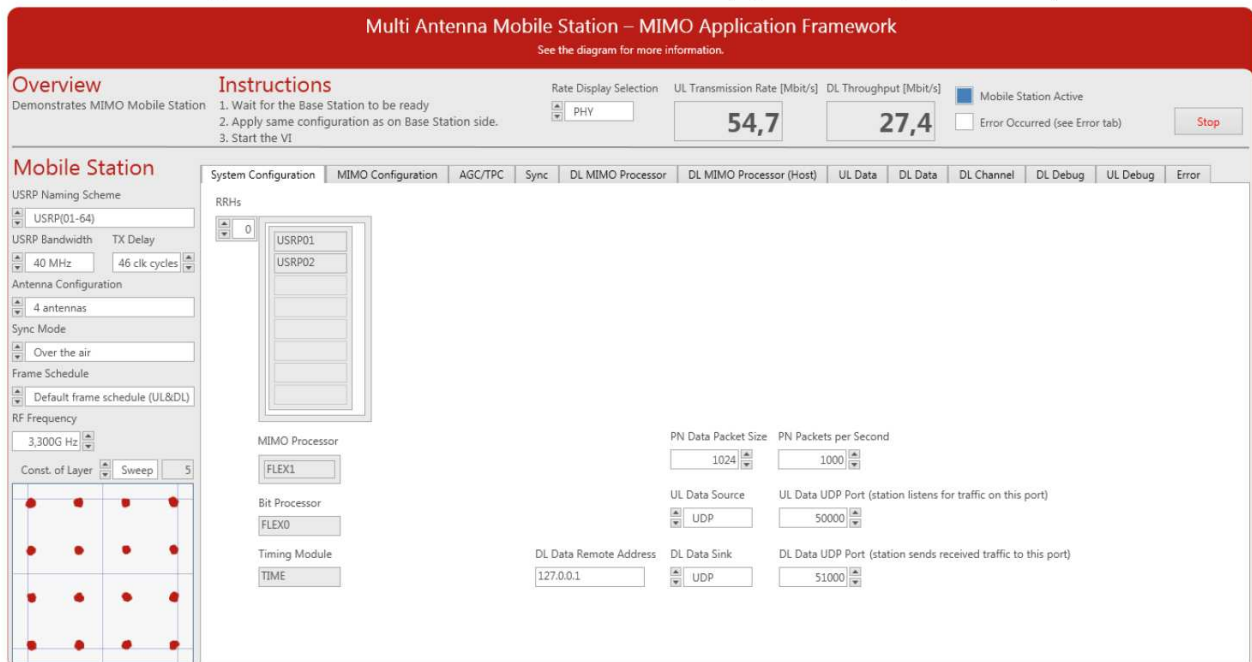

Multi-Antenna MS Indicators on MIMO Configuration Tab

The MIMO Configuration tab of **Multi Antenna Mobile Station Host.gvi** is shown in Figure 21, *Front Panel of Multi-Antenna MS (MIMO Configuration Tab)*. The following tables list the presented controls and indicators.

Table 49. Multi-Antenna MS Host – Controls on MIMO Configuration Tab

Control	Runtime	Description
Active Data Layers in TX	Yes	Activates the assigned layers to transmit data.
Layer Assignment	Yes	Assigns the layers to the multi-antenna MS. If the Boolean control of a layer is set to true, the assigned layer will transmit pilots.
MIMO Equalization Algorithm	Yes	Configures the equalization algorithm. The enumeration contains the following values: MMSE, MRC, and ZF.
Sigma	Yes	Selects the scaling factor that is used in the MGS-QRD algorithm of the MMSE channel estimator.
Multi User Interference Suppression	Yes	If switched on, the DL channels for all layers, not only the assigned layers, will be estimated and used for computing the MIMO equalizer. If switched off, only the channels corresponding to the assigned layers are estimated and used for computing the MIMO equalizer.

Table 50. Multi-Antenna MS Host - Indicators on MIMO Configuration Tab

Indicator	Description
more layers than antennas configured	Indicates if the number of configured active layers is larger than the Antenna Configuration . If it is the case, the extra activated layer will be deactivated by the code.
Frame Schedule Table	Shows the OFDM Frame Schedule of all 12 layers. The OFDM symbol types of each MS frame (140 OFDM Symbols) are presented. The OFDM symbol type could be Guard, Sync, DL pilot, DL data, UL pilot, and UL data. In addition, the modulation schemes of all layers are presented, which could be QPSK, 16-QAM, 64-QAM, and 256-QAM. The Frame Schedule Table indicator is controlled by the Frame Schedule control.
Normalized Singular Values	The Singular Value Decomposition of the channel estimates at different antennas and different subcarriers is used to get the singular values. A proper threshold can be selected by the user to estimate the channel rank. The effective number of spatial streams can then be identified.
SNR per Layer (dB)	A numerical array shows the measured SNR (dB) for all active layers.
EVM per Layer (%)	A numerical array shows the measured EVM defined as a percentage for all active layers. The earned value of EVM indicates to the quality of measurements. A small value of EVM (%) leads to a small BLER.

Multi-Antenna MS Control and Indicators on AGC/TPC Tab

Figure 40 shows the **AGC** tab of **Multi Antenna Mobile Station Host.gvi**. The following tables list the controls and indicators shown.

Table 51. Multi-Antenna MS Host – Controls on AGC Tab

Control	Runtime	Description
RX Gain - AGC	Yes	Sets the required parameters of AGC in the RX chain. It has three sets of controls and indicators: <ul style="list-style-type: none"> • AGC Settings • Manual Settings • Status
AGC Settings	Yes	Sets the required parameters of RX AGC.
AGC Mode	Yes	Switch between automatic and manual gain control.
AGC Target Midpoint	Yes	Target RX power in digital base band used in AGC mode auto . The optimal value depends on the PAPR of the received signal. Decrease the default setting if the PAPR increases, for instance, if the number of spatial layers is increased.
Manual Settings	Yes	Sets the required parameters of manual AGC mode.
Common RX Gain	Yes	RX Gain value applied to all antennas.
RX Gain Mode (Common/Individual)	Yes	Switch between common RX Gain and gain value per antenna.
RX Gains	Yes	Set gain values per antenna.
TX Power - TPC	Yes	Sets the required parameters of TPC in the TX chain. It has three sets of controls and indicators: <ul style="list-style-type: none"> • TPC Settings • Manual Settings • Status
TPC Settings / TPC Mode	Yes	Switch between automatic and manual transmit power.
TPC Settings /TPC Measurement Mode	Yes	The measured PSS Symbol Powers at all antennas are used in the TPC in two options: <ul style="list-style-type: none"> • Max: The maximum power is used to derive the TX power. • Average: The mean value of all measured powers is used to derive the TX power.
TPC Settings / Base Station Configuration	Yes	The values of the Base Station Configuration must match the settings on the BS.
TX Power	Yes	Sets the value similar to that of BS RF TX power in dBm.
RX Gain	Yes	Sets the value similar to that of BS RF RX gain in dB.
Active Layers	Yes	Sets the number of active layers in the system.
Antennas	Yes	Sets the number of antenna at the BS.
Manual Settings	Yes	Sets the required parameters of manual TPC mode.
Common TX Power	Yes	TX power value applied to all antennas.
TX Power Mode (Common/Individual)	Yes	Switch between common TX Power and TX Power per antenna.
TX Power	Yes	Sets the TX Power value per each antenna manually.

Table 52. Multi-Antenna MS Host – Indicators on AGC/TPC Tab

Indicator	Description
RX Gain – AGC / Status	Shows the status of the RX AGC.
RX Gain (Mean)	Shows the average of the actual analog RX RF gain of all antennas in dB. The number of antennas and active layers are equal. Either the AGC is manual or Auto, the configured RX gain is coerced by the capabilities of the device.
RX Clipping	Indicates a numeric overflow at the output of ADC. It is located beside RX Gain (Mean) indicator.
Coerced RX Gains	An array that shows the actual used analog RX RF gain in dB for all layers either the AGC Mode is auto or manual .
Max Symbol Power	An array that shows the maximum power in dBFS for all layers from the received OFDM symbols.
Max PSS Symbol Power	An array that shows the maximum power of the received PSS synchronization signal for all layers.
TX Power – TPC / Status	Shows the status of the TX power.
TX Power (Mean)	Numerical indication shows the mean coerced value of all antennas that currently used as a maximum RF TX output power level after applying the device's capabilities (range and resolution limitations) to the configured value either TPC is manual or Auto.
TX Clipping	Indicates a numeric overflow at the output of DAC. It is located beside TX Power (Mean) indicator.
Coerced TX Power	Indicates the coerced value that is actually used as a maximum RF TX output power in dBm for all layers after applying the device capabilities (range and resolution limitations) to the configured value.
Lower Limit and Upper Limit	Boolean indicators corresponding to the Coerced TX Power indicator. They show if the configured values of TX Power for all layers is coerced to the allowed range.

Figure 40. Front Panel of Multi-Antenna MS – AGC/TPC Tab

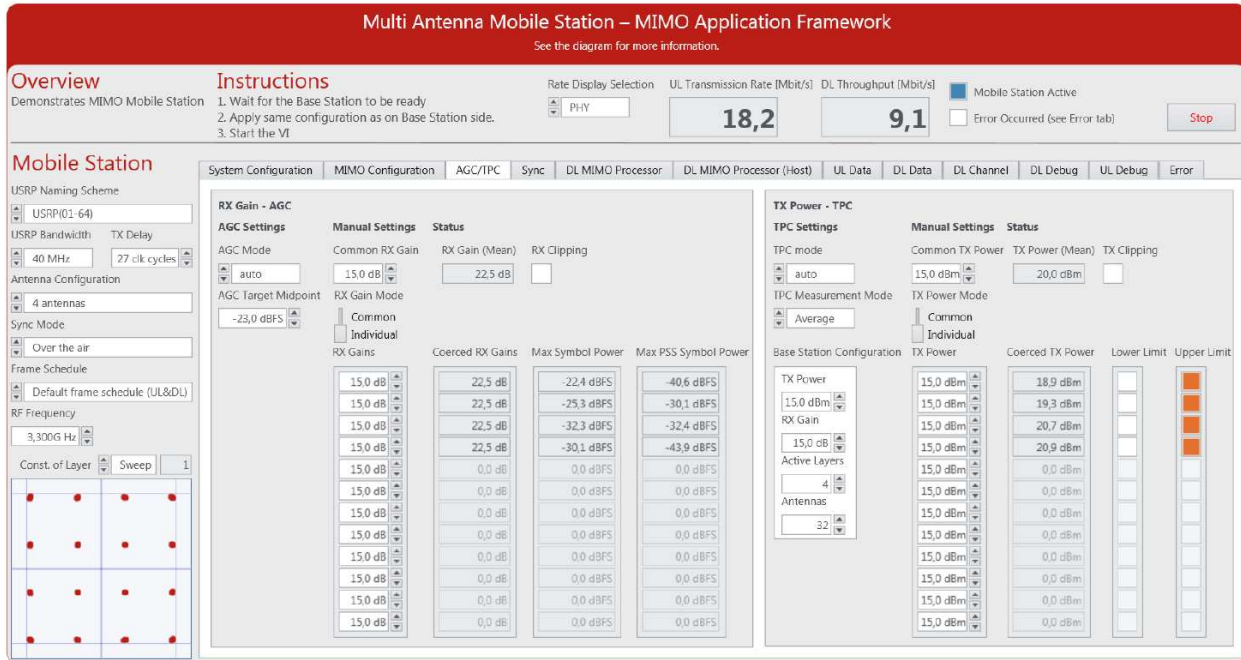

Multi-Antenna MS Control and Indicators on Sync Tab

The following tables show the MS controls and indicators that occur on **Sync** tab as shown in Figure 41.

Table 53. Multi-Antenna MS – Controls on Sync Tab

Control	Runtime	Description
Use Autodetected PSS Antenna	Yes	Boolean control to automatically select the received data on RF0 or RF1 of the first RRH in the MS for the synchronization process.
Manual PSS Antenna	Yes	Selects the RX stream of RF0 or RF1 of the first RRH in the multi-antenna MS to do the synchronization process. The sync result is provided then to the other RRHs in a daisy chain.
Select Antenna	Yes	Determines the antenna for which the received subcarriers are shown on the Amplitude of Received Subcarriers figure.

Table 54. Multi-Antenna MS – Indicators on Sync Tab

Indicator	Description
Autodetected PSS Antenna	Shows the RF port that has been selected for the synchronization.
Frame Timing Estimation [Samples]	Graphical indication (below-left) showing the timing estimation of the radio frame.
Sync Loss Counter	Counts how often the sync was lost since starting the node. The value of the Sync Loss Counter is read from the FPGA while the Signal Detected figure is updated every one second. Hence, if the synchronization is lost sometimes, the Sync Loss Counter will show that while the Signal Detected figure cannot show that.
Signal Detected	Graphical indication (below-middle) showing if the MS can detect the synchronization signal. The graph is updated every second.

Indicator	Description
CFO [Hz]	Graphical indication (below-right) showing the CFO in Hz.
Amplitude of Received Subcarriers	Graphical indication (above-left) shows the amplitude of received subcarriers of the selected antenna. The antenna can be selected using Select Antenna control that is located on the above side of the figure.
Signal Delay [Samples]	Graphical indication (above-right) shows the estimated time delay of all layers in LTE samples. This graphical representation can be used to calibrate the time delay of each layer manually by using the IO TX Delay control on the Sync tab.

Figure 41. Front Panel of Multi-Antenna MS (Sync Tab)

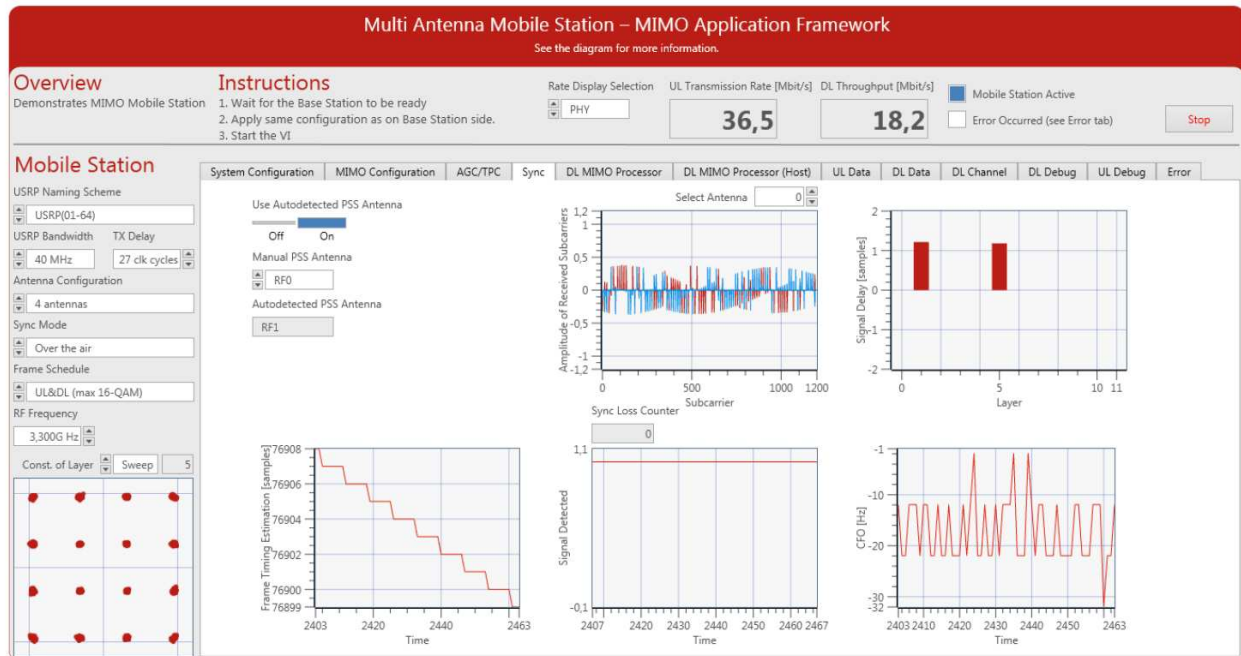

Multi-Antenna MS Indicators on DL MIMO Processor Tab

In this tab, the equalized subcarriers on the FPGA are presented. The controls and indicators are similar to those presented on the **UL MIMO Processor** tab of the **Base Station Host.gvi**. Table 20, *BS Host – Controls on UL MIMO Processor Tab*, and Table 21, *BS Host – Indicators on UL MIMO Processor Tab*, list the required controls and indicators, respectively.

Multi-Antenna MS Indicators on DL MIMO Processor (Host) Tab

This tab contains the same graphical indicators as on the previous tab. However, the channel estimation and equalization are performed on the host and not on the FPGA. The controls and indicators are similar to those presented on the **UL MIMO Processor (Host)** tab of the **Base Station Host.gvi**. Table 22, *BS Host – Control on UL MIMO Processor (Host) Tab*, and Table 23, *BS Host – Indicators on UL MIMO Processor (Host) Tab*, list the description of the controls and indicators, respectively.

Multi-Antenna MS Indicators on UL Data Tab

The UL transmission rate in Mbit/s is presented for all layers. The indicators are similar to those presented on the **DL Data** tab of the **Base Station Host.gvi**. Table 24, *BS Host – Indicators on DL Data Tab*, lists the descriptions of those indicators.

Multi-Antenna MS Indicators on DL Data Tab

The DL throughput in Mbit/s is presented for all layers. Additionally, the BLER for all layers has been presented. The indicators are similar to those presented on the **UL Data** tab of the **Base Station Host.gvi**. Table 25, *BS Host – Indicators on UL Data Tab*, lists the description of those indicators.

Multi-Antenna MS Indicators and Control on DL Channel Tab

The channel measurements are shown in this tab. The signal strength, the channel frequency response, and the channel impulse response in dBFS are presented for all layers. The indicators are similar to those presented on the **UL Channel** tab of the **Base Station Host.gvi**. Table 26, *BS Host – Control on UL Channel Tab*, and Table 27, *BS Host – Indicators on UL Channel Tab*, list the control and indicators, respectively.

Multi-Antenna MS Control and Indicators on DL Debug Tab

Figure 42 shows the screenshot of the DL Debug tab of **Multi Antenna Mobile Station Host.gvi**. This tab contains a block diagram of the DL part of the multi-antenna MS system overlaid with numeric and Boolean indicators which indicate the number of samples processed per second and fixed-point overflows. The indicators are similar to those presented on the **UL Debug** tab of the **Base Station Host.gvi**. The indicators are listed in Table 29, *BS Host – Indicators on UL Debug Tab*.

Figure 42. Front Panel of Multi-Antenna MS (DL Debug Tab)

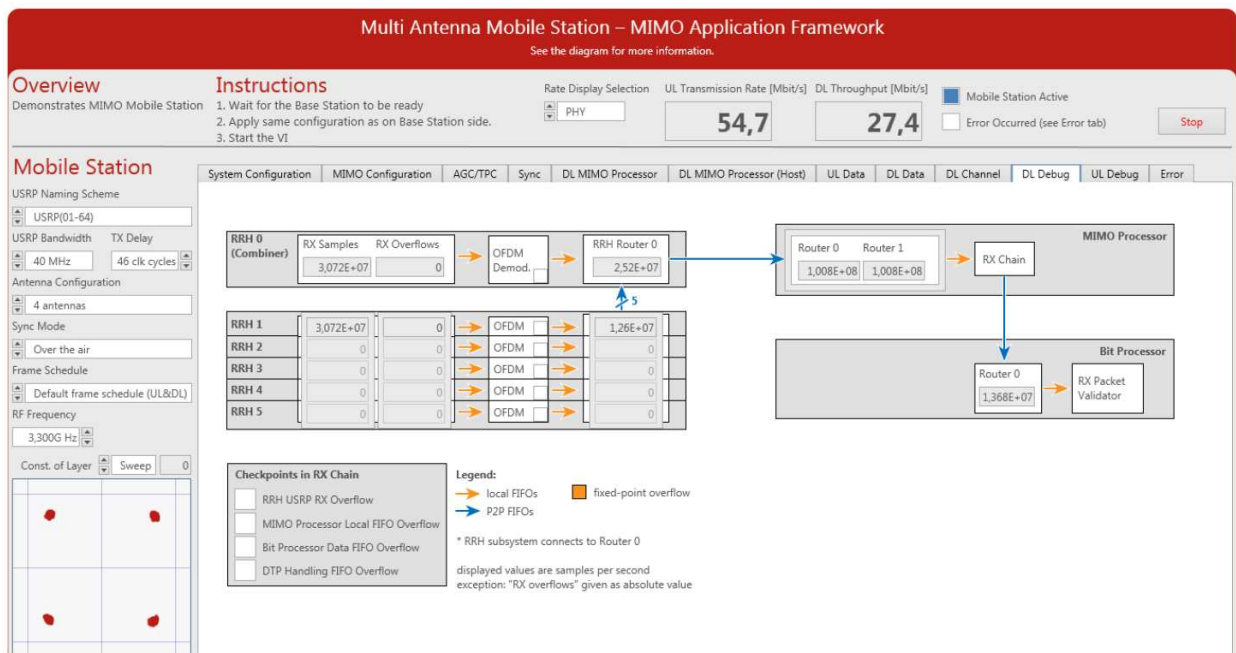

Multi-Antenna MS Control and Indicators on UL Debug Tab

Figure 43 shows the screenshot of the UL Debug tab of **Multi Antenna Mobile Station Host.gvi**. This tab contains a block diagram of the UL part of the multi-antenna MS system overlaid with numeric and

Boolean indicators which indicate the number of samples processed per second and fixed-point overflows. The indicators are similar to those presented on the **DL Debug** tab of the **Base Station Host.gvi**. The indicators are listed in Table 31, *BS Host – Indicators on DL Debug Tab*.

Figure 43. Front Panel of Multi-Antenna MS (UL Debug Tab)

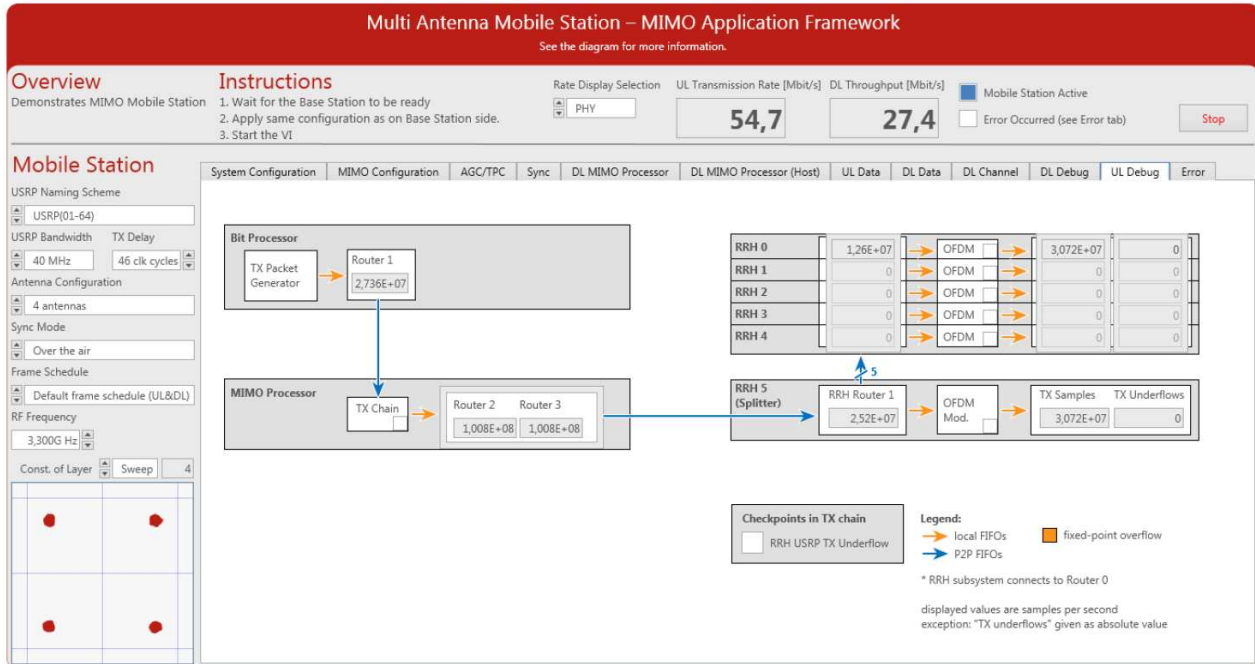

Multi-Antenna MS Indicators on Error Tab

The values are updated when the system stops, for example, upon receiving an error during initialization. The indicators are similar to those presented on the **Error** tab of the **Base Station Host.gvi**. The indicators are listed in Table 32, *BS Host – Indicators on Error Tab*.

Troubleshooting

Verify the following:

- Your hardware devices are connected correctly.
- The USRP devices are already switched on and connected to the host before the host is switched on. Otherwise the USRP devices may not properly recognized by the host.
- If any device, such as the USRP device, is switched off, restart the laptop or the PXI system.

You can access the known issues list online at ni.com/manuals.

Related Information

- [NI USRP and LabVIEW Communications System Design Suite Getting Started Guide](#)
- [IEEE Standards Association: 802.11 Wireless LANs](#)
- [3GPP TS 36.211 \(Physical channels and modulation\) Release 10](#)
- [3GPP TS 36.213 \(Physical layer procedure\) Release 10](#)

- Visit ni.com/r/MIMOAppFWManual to access the *LabVIEW Communications MIMO Application Framework Manual*.
- Visit ni.com/r/commsmanual to access the *LabVIEW Communications System Design Suite Manual* for information about LabVIEW concepts or objects used in this sample project.
- Use the **Context Help** window to learn basic information about LabVIEW objects as you move the cursor over each object. To display the **Context Help** window in LabVIEW, select **View»Context Help**.

Refer to the *NI Trademarks and Logo Guidelines* at ni.com/trademarks for more information on NI trademarks. Other product and company names mentioned herein are trademarks or trade names of their respective companies. For patents covering NI products/technology, refer to the appropriate location: **Help»Patents** in your software, the `patents.txt` file on your media, or the *National Instruments Patents Notice* at ni.com/patents. You can find information about end-user license agreements (EULAs) and third-party legal notices in the `readme` file for your NI product. Refer to the *Export Compliance Information* at ni.com/legal/export-compliance for the NI global trade compliance policy and how to obtain relevant HTS codes, ECCNs, and other import/export data. NI MAKES NO EXPRESS OR IMPLIED WARRANTIES AS TO THE ACCURACY OF THE INFORMATION CONTAINED HEREIN AND SHALL NOT BE LIABLE FOR ANY ERRORS. U.S. Government Customers: The data contained in this manual was developed at private expense and is subject to the applicable limited rights and restricted data rights as set forth in FAR 52.227-14, DFAR 252.227-7014, and DFAR 252.227-7015.

© 2016-2019 National Instruments. All rights reserved.