

COMPREHENSIVE SERVICES

We offer competitive repair and calibration services, as well as easily accessible documentation and free downloadable resources.

SELL YOUR SURPLUS

We buy new, used, decommissioned, and surplus parts from every NI series. We work out the best solution to suit your individual needs.

 Sell For Cash  Get Credit  Receive a Trade-In Deal

OBSOLETE NI HARDWARE IN STOCK & READY TO SHIP

We stock **New**, **New Surplus**, **Refurbished**, and **Reconditioned** NI Hardware.



Bridging the gap between the manufacturer and your legacy test system.

 1-800-915-6216

 www.apexwaves.com

 sales@apexwaves.com

All trademarks, brands, and brand names are the property of their respective owners.

Request a Quote

 **CLICK HERE**

PXIe-1085

LabVIEW Communications 802.11 Application Framework 2.2

This document provides basic information about how to get started with 802.11 Application Framework 2.2.

Table of Contents

System Requirements	2
Software Requirements	2
Hardware Requirements.....	3
Understanding the Components of This Sample Project.....	4
Folder Structure	4
Components.....	4
Statement of Compliance and Deviations	5
Running This Sample Project	5
Configuring the Hardware (Cabled)	6
Configuring the USRP System (Cabled).....	6
Configuring the FlexRIO System (Cabled)	6
Configuring the Hardware (Over-the-Air Transmission).....	7
Configuring the USRP System (Over-the-Air Transmission).....	7
Configuring the FlexRIO System (Over-the-Air Transmission).....	8
Running the LabVIEW Host Code.....	8
Description of Controls and Indicators	11
Basic Tab	11
Application Settings (Basic Tab).....	11
Static Runtime Settings (Basic Tab).....	11
Dynamic Runtime Settings (Basic Tab)	12
Indicators (Basic Tab)	13
MAC Tab.....	14
Dynamic Runtime Settings (MAC Tab).....	14
Graphs and Indicators (MAC Tab).....	15
RF & PHY Tab.....	16

Dynamic Runtime Settings (RF and PHY Tab)	17
Graphs and Indicators (RF and PHY Tab)	17
Advanced Tab.....	18
Static Runtime Settings (Advanced Tab).....	18
Dynamic Runtime Settings (Advanced Tab).....	19
Events Tab.....	19
Dynamic Runtime Settings (Events Tab).....	20
Status Tab.....	21
Graphs and Indicators (Status Tab).....	21
Additional Operation Modes and Configurations Options	23
RF Loopback Mode (Cabled)	23
Configuring the USRP System (RF Loopback Mode)	23
Configuring the FlexRIO System (RF Loopback Mode).....	23
Running the LabVIEW Host Code (RF Loopback Mode).....	24
RF Loopback Mode (Over-the-Air Transmission).....	24
Baseband Loopback Mode.....	24
Additional Configuration Options	25
PN Data Generator.....	25
Video Transmission	25
Troubleshooting.....	27
Known Issues.....	29
Related Information.....	29
Acronyms	30

System Requirements

Software Requirements

- Windows 7 SP1 (64-bit) or Windows 8.1 (64-bit)
- LabVIEW Communications System Design Suite 2.0
- NI-USRP 17.2 or later
- 802.11 Application Framework 2.2

Hardware Requirements

To use the 802.11 Application Framework for bidirectional data transmission, you need two NI RF devices—either USRP devices with 40 MHz, 120 MHz, or 160 MHz bandwidth, or FlexRIO modules. The devices should be connected to different host computers, which can be either laptops, PCs, or PXI chassis. Figure 1 shows the setup of two stations either by using RF cables (left) or antennas (right). Table 1 presents the required hardware depending on the chosen configuration.

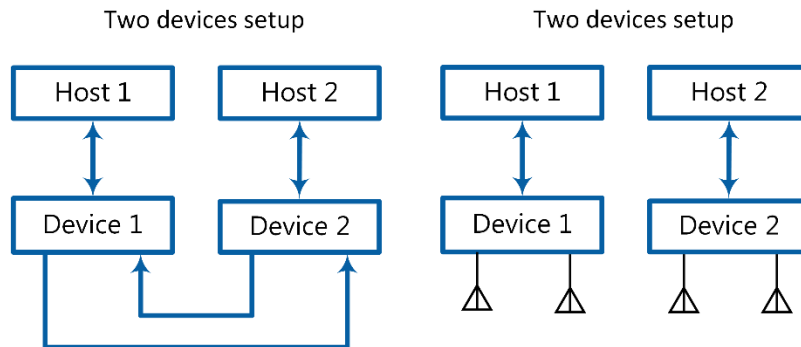

Figure 1 Hardware Configuration Options

Table 1 Required Hardware Accessories

Configuration	Both setups				USRP RIO setup		FlexRIO FPGA/FlexRIO RF adapter module setup	
	Host PC	SMA Cable	Attenuator	Antenna	USRP device	MXI Adapter	FlexRIO FPGA module	FlexRIO Adapter module
Two devices, cabled	2	2	2	0	2	2	2	2
Two devices, over-the-air	2	0	0	4	2	2	2	2

- Controllers: Recommended—PXIe-1085 Chassis or PXIe-1082 Chassis with a PXIe-8135 Controller installed.
- SMA cable: Female/female cable that is included with the USRP RIO device.
- Antenna
- USRP device: USRP-2940/2942/2943/2944/2950/2952/2953/2954 Software Defined Radio Reconfigurable Devices with 40 MHz, 120 MHz, or 160 MHz bandwidth, or the USRP-2974 Software Defined Radio Stand-Alone Device with 160 MHz bandwidth.
- Attenuator with 30 dB attenuation and male/female SMA connectors that are included with the USRP RIO device.
Note: For FlexRIO/FlexRIO adapter module setup, the attenuator is not required.
- FlexRIO FPGA module: PXIe-7975/7976 FPGA Module for FlexRIO
- FlexRIO adapter module: NI-5791 RF Adapter Module for FlexRIO

The preceding recommendations assume you are using PXI-based host systems. You can also use a PC with a PCI-based or PCI Express-based MXI adapter, or a laptop with an Express card-based MXI adapter.

Ensure your host has at least 20 GB of free disk space and 16 GB of RAM.

Notice: Before using your hardware, read all product documentation to ensure compliance with safety, EMC, and environmental regulations.

Understanding the Components of This Sample Project

The project is comprised of LabVIEW host code and LabVIEW FPGA code for the supported USRP RIO or FlexRIO hardware targets. The related folder structure and the components of the project are described in the next subsections.

Folder Structure

To create a new instance of the 802.11 Application Framework, launch LabVIEW Communications System Design Suite 2.0 by selecting **LabVIEW Communications 2.0** from the **Start** menu. From the Project Templates on the launched **Project** tab, select **Application Frameworks**. To launch the project, select:

- 802.11 Design USRP RIO v2.1 when using USRP devices
- 802.11 Design FlexRIO v2.1 when using FlexRIO FPGA/FlexRIO modules
- 802.11 Simulation v2.1 to run the FPGA code of physical transmitter (TX) and receiver (RX) signal processing in simulation mode. The related guide of the simulation project is attached to it.

For 802.11 Design projects, the following files and folders are created inside the specified folder:

- **802.11 Design USRP RIO v2.1.lvproject / 802.11 Design FlexRIO RIO v2.1.lvproject**—This project file contains information about the linked subVIs, targets and build specifications.
- **802.11 Host.gvi**—This top-level host VI implements an 802.11 station. The host interfaces with the bitfile build from the top-level FPGA VI, **802.11 FPGA STA.gvi**, located in the target specific subfolder.
- **Builds**—This folder contains the precompiled bitfiles for the selected target device.
- **Common**—The common library contains generic subVIs for the host and FPGA that are used in the 802.11 Application Framework. This code includes mathematical functions and type conversions.
- **FlexRIO/USRP RIO**— These folders contain target-specific implementations of host and FPGA subVIs, which include code to set gain and frequency. This code is in most cases adapted from the given target-specific streaming sample projects. They also contain the target-specific top-level FPGA VIs.
- **802.11 v2.1**—This folder comprises the 802.11 functionality itself separated into several FPGA folders and a host directory.

Components

The 802.11 Application Framework provides a real-time orthogonal frequency-division multiplexing (OFDM) physical layer (PHY) and media access control (MAC) implementation for an IEEE 802.11-based system. The 802.11 Application Framework LabVIEW project implements the functionality of one station, including RX and TX functionality.

Statement of Compliance and Deviations

The 802.11 Application Framework is designed to be compliant with the IEEE 802.11 specifications. To keep the design easily modifiable, the 802.11 Application Framework focuses on the core functionality of the IEEE 802.11 standard.

- 802.11a- (Legacy mode) and 802.11ac- (Very High Throughput mode) compliant PHY
- Training field based packet detection
- Signal and data field encoding and decoding
- Clear Channel Assessment (CCA) based on energy and signal detection
- Carrier sense multiple access with collision avoidance (CSMA/CA) procedure including retransmission
- Random Backoff procedure
- 802.11a and 802.11ac compliant MAC components to support request-to-send/clear-to-send (RTS/CTS), Data frame, and acknowledgement (ACK) frame transmission
- ACK generation with 802.11 IEEE-compliant short interframe spacing (SIFS) timing (16 μ s)
- Network allocation vector (NAV) support
- MAC protocol data unit (MPDU) generation and multi-node addressing
- L1/L2 API that allows external applications implementing upper MAC functionalities like join procedure to access functionalities of middle and lower MAC

The 802.11 Application Framework supports the following features:

- Long guard interval only
- Single input single output (SISO) architecture, ready for multiple-input multiple-output (MIMO) configurations
- VHT20, VHT40, and VHT80 for the 802.11ac standard. For 802.11ac 80 MHz bandwidth, the support is limited up to modulation and coding scheme (MCS) number 4.
- Aggregated MPDU (A-MPDU) with a single MPDU for the 802.11ac standard
- Packet-by-packet automatic gain control (AGC) allowing for over the air transmission and reception.

Visit ni.com/info and enter the Info Code [80211AppFWManual](#) to access *the LabVIEW Communications 802.11 Application Framework Manual* for more information about the 802.11 Application Framework design.

Running This Sample Project

The 802.11 Application Framework supports interaction with an arbitrary number of stations, hereafter referred to as RF Multi Station Mode. Other operation modes are described in the “Additional Operation Modes and Configurations Options” section. In the RF Multi Station Mode, each station acts as a single 802.11 device. The following descriptions assume that there are two independent stations, each running on its own RF device. They are referred to as Station A and Station B.

Configuring the Hardware (Cabled)

Complete the steps applicable to your configuration.

Configuring the USRP System (Cabled)

1. Ensure the USRP devices are properly connected to the host systems running LabVIEW Communications System Design Suite.
2. Complete the following steps to create RF connections as shown in Figure 2.
 - a. Connect two 30 dB attenuators to RF0/TX1 ports on Station A and Station B.
 - b. Connect the other end of the attenuators to two RF cables.
 - c. Connect the other end of the RF cable coming from Station A to RF1/RX2 port of Station B.
 - d. Connect the other end of the RF cable coming from Station B to RF1/RX2 port of Station A.
3. Power on the USRP devices.
4. Power on the host systems.

The RF cables should support the operating frequency.

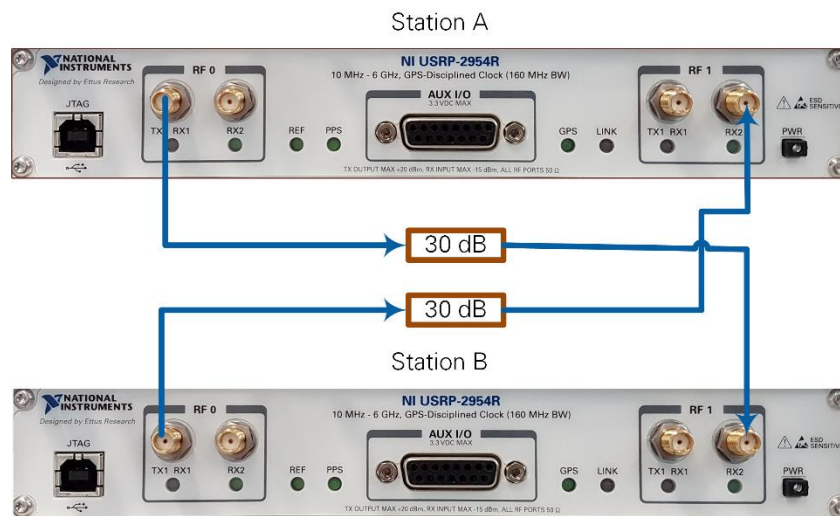

Figure 2 Cabled Connection of USRP Devices

Configuring the FlexRIO System (Cabled)

1. Ensure the FlexRIO devices are properly connected to the host systems running LabVIEW Communications System Design Suite.
2. Complete the following steps to create RF connections as shown in Figure 3.
 1. Connect the TX port of Station A to RX port of Station B using RF cable.
 2. Connect the TX port of Station B to RX port of Station A using RF cable.
3. Power on the host systems.

The RF cables should support the operating frequency.

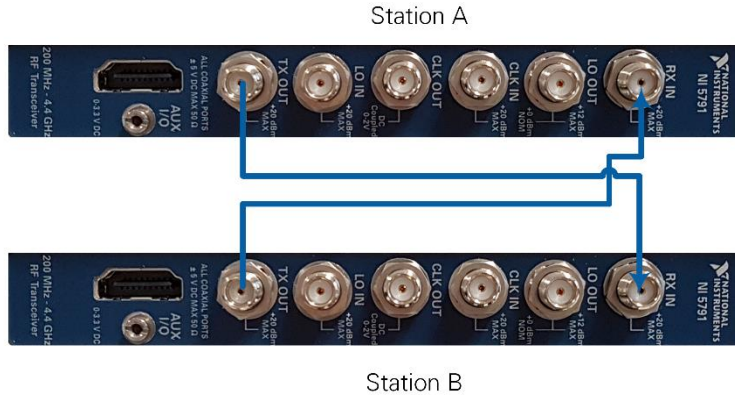

Figure 3 FlexRIO Adapter Module Cabled Connection

Configuring the Hardware (Over-the-Air Transmission)

Over-the-air transmission is similar to the cabled setup. Cables are replaced by antennas suitable for the selected channel center frequency and system bandwidth.

Notice: Before using your hardware, read all product documentation to ensure compliance with safety, EMC, and environmental regulations.

Configuring the USRP System (Over-the-Air Transmission)

1. Ensure the USRP devices are properly connected to the host systems running LabVIEW.
2. Create the following RF connections as shown in Figure 4:
 - RF0/TX1 on Station A to Antenna 1
 - RF1/RX2 on Station A to Antenna 2
 - RF0/TX1 on Station B to Antenna 3
 - RF1/RX2 on Station B to Antenna 4
3. Power on the USRP devices.
4. Power on the host systems.



Figure 4 Antenna Connection for USRP Devices

Configuring the FlexRIO System (Over-the-Air Transmission)

1. Ensure the FlexRIO adapter module devices are properly connected to the host system running LabVIEW Communications System Design Suite.
2. Create the following RF connections as shown in Figure 5:
 - TX on Station A to Antenna 1
 - RX on Station A to Antenna 2
 - TX on Station B to Antenna 3
 - RX on Station B to Antenna 4
3. Power on the host systems.

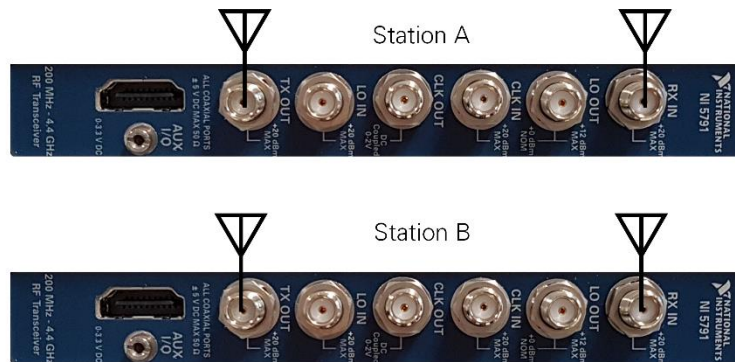

Figure 5 Antenna Connection for FlexRIO/FlexRIO Adapter Module Devices

Running the LabVIEW Host Code

Ensure the LabVIEW Communications System Design Suite 2.0 and the 802.11 Application Framework 2.1 are installed on your systems. Installation is started by running setup.exe from the provided installation media. Follow the installer prompts to complete the installation process.

The required steps to run the LabVIEW host code on two stations are summarized in the following:

1. For Station A on the first host:
 - a. Launch LabVIEW Communications System Design Suite by selecting **LabVIEW Communications 2.0** from the Start menu.
 - b. From the **PROJECTS** tab, select **Application Frameworks » 802.11 Design...** to launch the project.
 - Select **802.11 Design USRP RIO v2.1** if you are using a USRP setup.
 - Select **802.11 Design FlexRIO v2.1** if you are using a FlexRIO setup.
 - c. (802.11 Design USRP 2974 v2.2 only) Ensure you are mapped to the RT target.
 - i. Open System Diagram.
 - ii. Select the USRP device.
 - iii. On the Configuration pane, check that **mapped to** names the correct USRP.
 - iv. If **mapped to** is **do not map**, then map to the correct USRP by either selecting the right USRP from the dropdown list or by **map to another device by address**. When you map to another device, use the device IP address and root as user name. Leave **password** empty if you did not change it.
 - d. Within that project, the top-level host VI **802.11 Host.gvi** appears.

- e. (FlexRIO and USRP RIO devices only. Skip this step when using the USRP-2974.) Configure the RIO identifier in the **RIO Device** control. You can use NI Measurement & Automation Explorer (MAX) to get the RIO identifier for your device. The USRP RIO device bandwidth (if 40 MHz, 80 MHz, and 160 MHz) is identified inherently.
2. Repeat the step 1 for Station B on the second host.
3. Set the **Station Number** of Station A to 1 and that of Station B to 2.
4. For FlexRIO setup, set the **Reference Clock** to PXI_CLK or REF IN/ClkIn.
 - a. For PXI_CLK: The reference is taken from the PXI chassis.
 - b. REF IN/ClkIn: The reference is taken from the ClkIn port of NI-5791 adapter module.
5. Properly adjust the settings of **Device MAC Address** and **Destination MAC Address** at both stations.
 - a. Station A: Set the **Device MAC Address** and **Destination MAC Address** to 46:6F:4B:75:6D:61 and 46:6F:4B:75:6D:62 (the default values).
 - b. Station B: Set the **Device MAC Address** and **Destination MAC Address** to 46:6F:4B:75:6D:62 and 46:6F:4B:75:6D:61.
6. For each station, run the LabVIEW host VI by clicking the run button (▶).
 - a. If successful, the **Device Ready** indicator lights.
 - b. If you receive an error, try one of the following:
 - Ensure your device is connected properly.
 - Check the configuration of **RIO Device**.
7. Enable Station A by setting the **Enable Station** control to **On**. The **Station Active** indicator should be **on**.
8. Enable Station B by setting the **Enable Station** control to **On**. The **Station Active** indicator should be **on**.
9. Select the **MAC** tab, and verify the shown RX Constellation matches the modulation and coding scheme configured using the **MCS** and **Subcarrier Format** parameters on the other station. For example, leave the **Subcarrier format** and **MCS** to default on Station A and set the **Subcarrier format** to 40 MHz (IEEE 802.11 ac) and **MCS** to 5 on Station B. The 16-quadrature amplitude modulation (QAM) is used for MCS 4 and occurs on the user interface of Station B. The 64 QAM is used for MCS 5 and it is occurred on the user interface of Station A.
10. Select the **RF & PHY** tab, and verify the shown RX Power spectrum is similar to the selected **Subcarrier format** on the other station. Station A shows 40 MHz RX power spectrum while Station B shows 20 MHz RX power spectrum.

Note: USRP devices with 40 MHz bandwidth cannot transmit or receive packets encoded with 80 MHz bandwidth.

The 802.11 Application Framework user interfaces of Station A and B are shown in Figure 6 and Figure 7, respectively. To monitor the status of each station, the 802.11 Application Framework provides a variety of indicators and graphs. All application settings as well as graphs and indicators are described in the following subsections. The controls on the front panel are classified in the following three sets:

- **Application Settings:** Those controls should be set before turning on the station.
- **Static Runtime Settings:** Those controls need to switch off and then on the station. The **Enable Station** control is used for that.
- **Dynamic Runtime Settings:** Those controls can be set where the station is running.

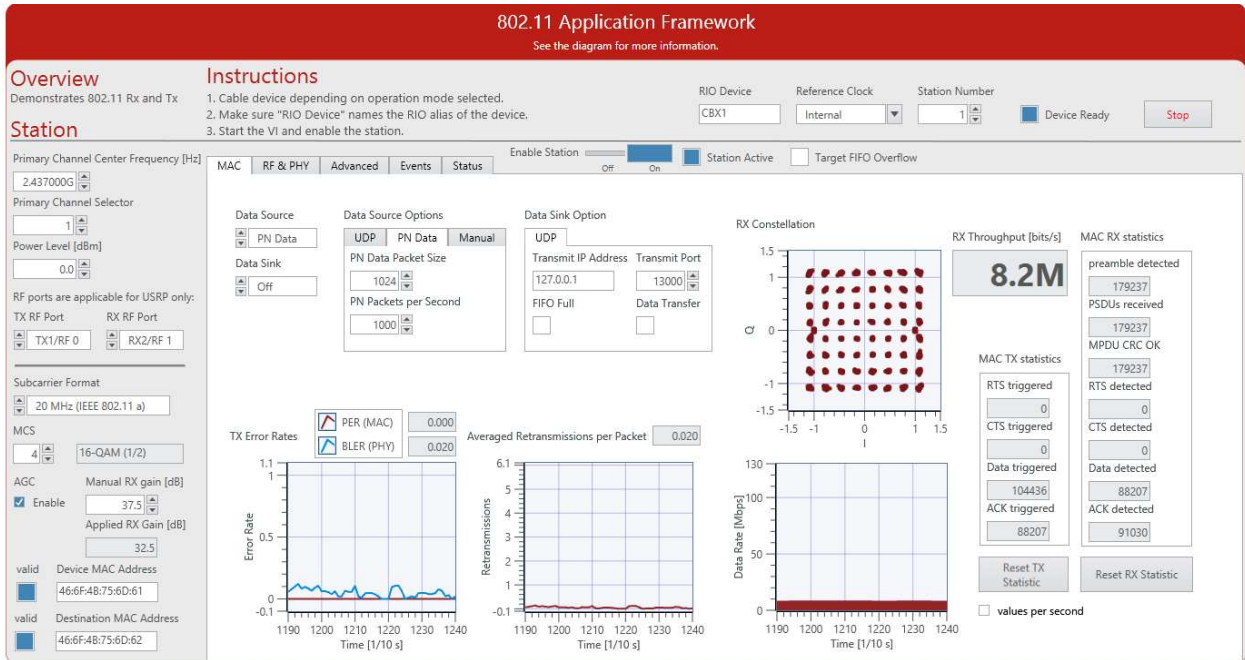

Figure 6 Application Framework User Interface – Station A: MAC Tab

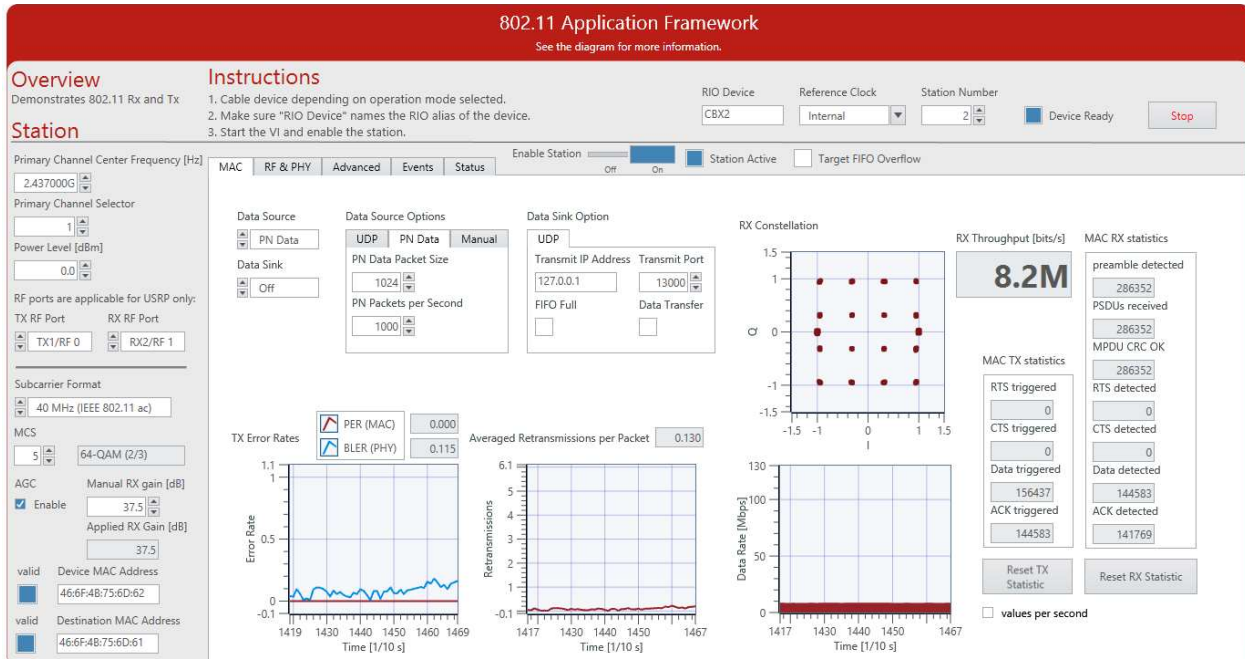

Figure 7 Application Framework User Interface – Station B: MAC Tab

Description of Controls and Indicators

Basic Tab

Application Settings (Basic Tab)

Application settings are applied when the VI starts and cannot be changed once the VI is up and running. To change these settings, stop the VI, apply changes, and restart the VI. They are shown in Figure 6.

Table 2 Application Settings (Basic Tab)

Parameter	Description
RIO Device	The RIO address of the RF hardware device.
Reference Clock	<p>Configures the reference for the device clocks. The reference frequency must be 10 MHz. You can choose from the following sources:</p> <p>Internal—Uses the internal reference clock.</p> <p>REF IN / ClkIn—The reference is taken from the REF IN port (USRP devices) or the ClkIn port (NI-5791).</p> <p>GPS—The reference is taken from the GPS module. Only applicable for the USRP-2950/2952/2953/2954/2974 devices.</p> <p>PXI_CLK—The reference is taken from the PXI chassis. Only applicable for PXIe-7975/7976 targets with NI-5791 adapter modules.</p>
Operation Mode	<p>It has been set as a constant in the block diagram. The 802.11 Application Framework provides the following modes:</p> <p>RF Loopback—Connects the TX path of one device with the RX path of the same device using RF cabling or using antennas.</p> <p>RF Multi Station—Regular data transmission with two or more independent stations running on individual devices connected either with antennas or by cabled connections. RF Multi Station is the default operation mode.</p> <p>Baseband loopback—Similar to RF loopback, but the external cable loopback is replaced by the internal digital baseband loopback path.</p>

Static Runtime Settings (Basic Tab)

Static runtime settings can only be changed while the station is switched off. The parameters are applied when the station is switched on. They are shown in Figure 6.

Table 3 Static Runtime Settings (Basic Tab)

Parameter	Description
Station Number	Numerical control to set the station number. Each running station should have a different number. It can be up to 10. If the user would like to increase the number of running stations, the cache of MSDU Sequence Number assignment and Duplicate Detection should be increased to the required value, since the default value is 10.
Primary Channel Center Frequency [Hz]	It is the primary channel center frequency of the transmitter in Hz. Valid values depend on the device the station is running on.
Primary Channel Selector	Numeric control to determine which subband is used as the primary channel. The PHY covers 80 MHz bandwidth, which can be divided into four subbands {0,...,3} of 20 MHz bandwidth for the non-high throughput (HT) signal. For wider bandwidths the subbands get combined. Visit ni.com/info and enter the Info Code 80211AppFWManual to access the <i>LabVIEW Communications 802.11 Application Framework Manual</i> for more information about channelization.
Power Level [dBm]	Output power level considering the transmission of a continuous wave (CW) signal that has full digital to analog converter (DAC) range. The high peak-to-average power ratio of OFDM means that the output power of transmitted 802.11 frames is usually 9 dB to 12 dB below the adjusted power level.
TX RF Port	The RF port used for TX (applicable only for USRP devices).
RX RF Port	The RF port used for RX (applicable only for USRP devices).
Device MAC Address	MAC address associated with the station. The Boolean Indicator shows if the given MAC address is valid or not. The MAC address validation is done in the dynamic mode.

Dynamic Runtime Settings (Basic Tab)

Dynamic Runtime Settings can be changed any time and are applied immediately, even when the station is active. They are shown in Figure 6.

Table 4 Dynamic Runtime Settings (Basic Tab)

Parameter	Description
Subcarrier Format	Allows you to switch between IEEE 802.11 standard formats. The supported formats are the following: <ul style="list-style-type: none"> • 802.11a with 20 MHz Bandwidth • 802.11ac with 20 MHz Bandwidth • 802.11ac with 40 MHz Bandwidth • 802.11ac with 80 MHz Bandwidth (supported MCS up to 4)
MCS	Modulation and coding scheme index used to encode data frames. ACK frames are always sent with MCS 0. Be aware that not all MCS values are applicable for all subcarrier formats and the meaning of

	the MCS changes with the subcarrier format. The text field next to the MCS field shows the modulation scheme and coding rate for the current MCS and Subcarrier Format.
AGC	If enabled, the optimum gain setting is chosen depending on the received signal power strength. The RX gain value is taken from Manual RX Gain if the AGC has been disabled.
Manual RX Gain [dB]	Manual RX gain value. Applied if AGC is disabled.
Destination MAC Address	MAC address of the destination to which packets should be sent. The Boolean indicator shows if the given MAC address is valid or not. If running in RF loopback mode, the Destination MAC Address and the Device MAC Address should be similar.

Indicators (Basic Tab)

The following table presents the indicators occurred on the main front panel as it is shown in Figure 6.

Table 5 Indicators (Basic Tab)

Parameter	Description
Device Ready	Boolean indicator shows if the device is ready. If you receive an error, try one of the following: <ul style="list-style-type: none"> • Ensure your RIO device is connected properly. • Check the configuration of RIO Device. • Check the station number. It should be different if more than one station is running on the same host.
Target FIFO Overflow	Boolean indicator that lights if there is an overflow in the target to host (T2H) first-in-first-out memory buffers (FIFOs). If one of the T2H FIFOs overflows, its information is no longer reliable. Those FIFOs are as follows: <ul style="list-style-type: none"> • T2H RX Data overflow • T2H Constellation overflow • T2H RX Power Spectrum overflow • T2H Channel Estimation overflow • TX to RF FIFO overflow
Station Active	Boolean indicator shows if the station RF is active after enabling the station by setting the Enable Station control to On .
Applied RX Gain [dB]	A numerical indicator shows RX gain value currently applied. This value is the Manual RX Gain when the AGC is disabled, or the calculated RX gain when AGC is enabled. In both cases, the gain value is coerced by the capabilities of the device.
Valid	Boolean indicators show if the given Device MAC Address and Destination MAC Address associated with the stations are valid.

MAC Tab

The following tables list the controls and indicators that are placed on the MAC Tab as it is shown in Figure 6.

Dynamic Runtime Settings (MAC Tab)

Table 6 Dynamic Runtime Settings (MAC Tab)

Parameter	Description
Data Source	<p>Determines the source of MAC frames send from the host to the target.</p> <p>Off—This method is useful to disable transmitting TX data while the TX chain is active to trigger ACK packets.</p> <p>UDP—This method is useful for showing demos, such as when using an external video streaming application, or for using external network testing tool, such as Iperf. In this method, input data arrives at or is generated from the 802.11 station using user datagram protocol (UDP).</p> <p>PN Data—This method sends random bits and is useful for functional tests. Packet size and rate can be easily adapted.</p> <p>Manual—This method is useful to trigger single packets for debugging purposes.</p> <p>External—Allow a potential external upper MAC realization or other external applications to use the MAC & PHY functionalities provided by the 802.11 Application Framework.</p>
Data Source Options	<p>Each tab shows the options for the corresponding data sources.</p> <p>UDP Tab—A free UDP port to retrieve data for the transmitter is derived inherently based on the station number.</p> <p>PN Tab - PN Data Packet Size—Packet size in bytes (range is limited to 4061, which is a single A-MPDU reduced by MAC overhead)</p> <p>PN Tab - PN Packets per Second—Average number of packets to transmit per second (limited to 10,000. The achievable throughput might be less depending on the configuration of the station).</p> <p>Manual Tab – Trigger TX—A Boolean control to trigger a single TX packet.</p>
Data Sink	<p>It has the following options:</p> <ul style="list-style-type: none"> • Off—Data is discarded. • UDP—If enabled, received frames are forwarded to the configured UDP address and port (see below).
Data Sink Option	<p>It has the following required configurations for the UDP data sink option:</p>

	<ul style="list-style-type: none"> • Transmit IP Address—Destination IP address for the UDP output stream. • Transmit Port—Target UDP port for UDP output stream, usually between 1,025 and 65,535.
Reset TX Statistic	A Boolean control to reset all counters of MAC TX Statistics cluster.
Reset RX Statistic	A Boolean control to reset all counters of MAC RX Statistics cluster.
values per second	A Boolean control to show the MAC TX Statistics and MAC RX Statistics as either the accumulated values since the last reset or the values per second.

Graphs and Indicators (MAC Tab)

The following table presents the indicators and graphs presented on the MAC Tab as it is shown in Figure 6.

Table 7 Graphs and Indicators (MAC Tab)

Parameter	Description
Data Source Options - UDP	<p>Receive Port—Source UDP port of UDP input stream.</p> <p>FIFO Full—Indicates that the socket buffer of the UDP reader is small to read the given data, so packets are dropped. Increase the socket buffer size.</p> <p>Data Transfer—Indicates that the packets are successfully read from the given port. Look to video streaming for more details.</p>
Data Sink Option - UDP	<p>FIFO Full—Indicates that the socket buffer of the UDP sender is small to receive the payload from the RX Data direct memory access (DMA) FIFO, so packets are dropped. Increase the socket buffer size.</p> <p>Data Transfer—Indicates that the packets are successfully read from the DMA FIFO and forwarded to the given UDP port.</p>
RX Constellation	Graphical indication shows the constellation of RX in-phase/quadrature (I/Q) samples of the received data field.
RX Throughput [bits/s]	Numerical indication shows the data rate of successful received and decoded frames matching the Device MAC Address .
Data Rate [Mbps]	Graphical indication shows the data rate of successful received and decoded frames matching the Device MAC Address .
MAC TX Statistics	<p>Numerical indication shows the values of the following counters related to MAC TX. The presented values could be the accumulated values since the last reset or the values per second based on the status of the Boolean control values per second.</p> <ul style="list-style-type: none"> • RTS Triggered • CTS Triggered • Data Triggered • ACK Triggered
MAC RX Statistics	Numerical indication shows the values of the following counters related to MAC RX. The presented values could be the

	<p>accumulated values since the last reset or the values per second based on the status of the Boolean control values per second.</p> <ul style="list-style-type: none"> • Preamble detected (by the synchronization) • PHY service data units (PSDUs) received (frames with valid physical layer convergence procedure (PLCP) header, frames without format violations) • MPDU CRC OK (the frame check sequence (FCS) check passes) • RTS detected • CTS detected • Data detected • ACK detected
<p>TX Error Rates</p>	<p>Graphical indication shows the TX packet error rate and TX block error rate. The TX packet error rate is calculated as a ratio of successful MPDU transmitted to the number of transmission tries. The TX block error rate is calculated as a ratio of successful MPDU transmitted to the total number of transmission. The most recent values are displayed on the upper right of the graph.</p>
<p>Averaged Retransmissions per Packet</p>	<p>Graphical indication shows the average number of transmission tries. The recent value is displayed on the upper right of the graph.</p>

RF & PHY Tab

The following tables list the controls and indicators that are placed on the RF & PHY Tab as it is shown in Figure 8.

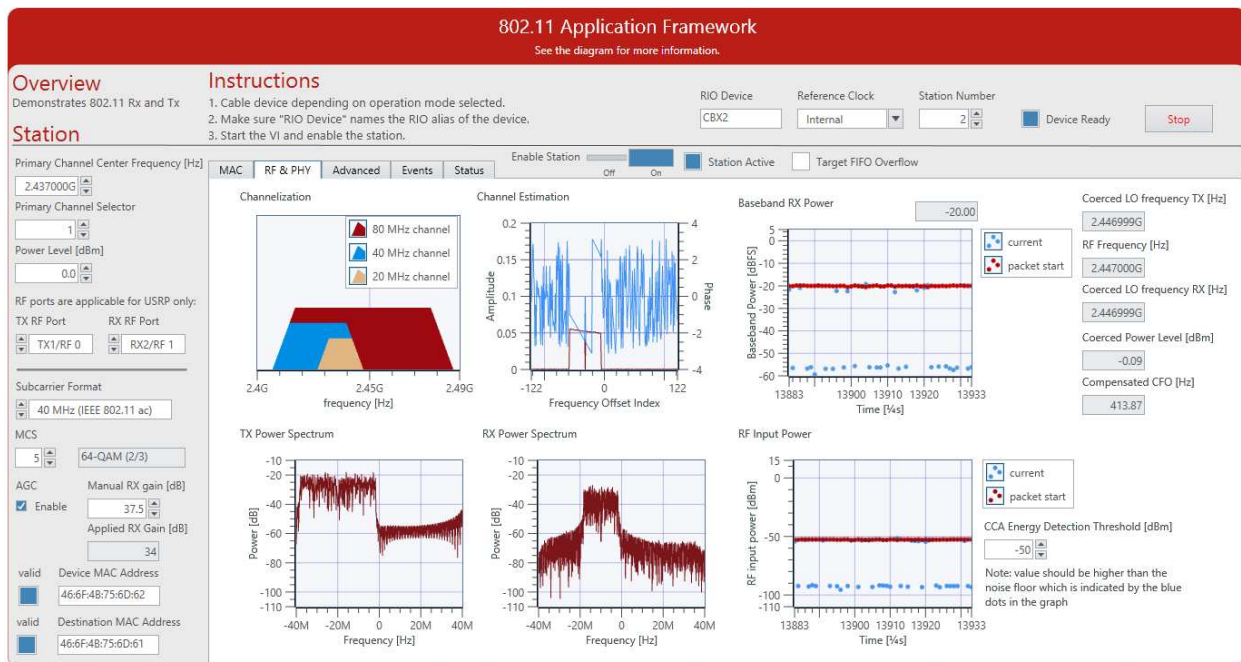

Figure 8 Application Framework RF & PHY Tab

Dynamic Runtime Settings (RF and PHY Tab)

Table 8 Dynamic Runtime Settings (RF and PHY Tab)

Parameter	Description
CCA Energy Detection Threshold [dBm]	If the energy of the received signal is above the threshold, the station qualifies the medium as busy and interrupts its Backoff procedure, if any. Set the CCA Energy Detection Threshold [dBm] control to a value which is higher than the minimal value of the current curve in the RF Input Power graph.

Graphs and Indicators (RF and PHY Tab)

Table 9 Graphs and Indicators (RF and PHY Tab)

Parameter	Description
Coerced LO Frequency TX [Hz]	Actual used TX frequency on target.
RF Frequency [Hz]	The RF center frequency after the adjustment based on the Primary Channel Selector control and the operating bandwidth.
Coerced LO Frequency RX [Hz]	Actual used RX frequency on target.
Coerced Power Level [dBm]	Power level of a continuous wave of 0 dBFS that provides for the current device settings. The average output power of 802.11 signals is approximately 10 dB below this level. Indicates the actual power level considering RF frequency and device-specific calibration values from the EEPROM.
Compensated CFO [Hz]	Carrier frequency offset (CFO) detected by coarse frequency estimation unit. For FlexRIO/FlexRIO adapter module, set the reference clock to PXI_CLK or REF IN/ClkIn.
Channelization	Graphical indication shows which sub-band is used as the primary channel based on the Primary Channel Selector. The PHY covers 80 MHz bandwidth, which can be divided into four sub-bands {0,...,3} of 20 MHz bandwidth for the non-HT signal. For wider bandwidths (40 MHz or 80 MHz), the sub-bands get combined. Visit ni.com/info and enter the Info Code 80211AppFWManual to access the <i>LabVIEW Communications 802.11 Application Framework Manual</i> for more information about channelization.
Channel Estimation	Graphical indication shows the amplitude and phase of the estimated channel (based on L-LTF and VHT-LTF).
Baseband RX Power	Graphical indication displays the baseband signal power at packet start. The numerical indicator shows the actual receiver's baseband power. When the AGC is enabled, the 802.11 Application Framework attempts to keep this value at the given AGC target signal power in Advanced tab by changing the RX gain accordingly.
TX Power Spectrum	A snapshot of the current baseband spectrum from the TX.
RX Power Spectrum	A snapshot of the current baseband spectrum from the RX.
RF Input Power	Displays the current RF input power in dBm regardless of the type of incoming signal if an 802.11 packet has been detected. This

indicator displays the RF input power, in dBm, currently being measured, as well as at the most recent packet start.

Advanced Tab

The following table list the controls that are placed on the Advanced Tab as it is shown in Figure 9.

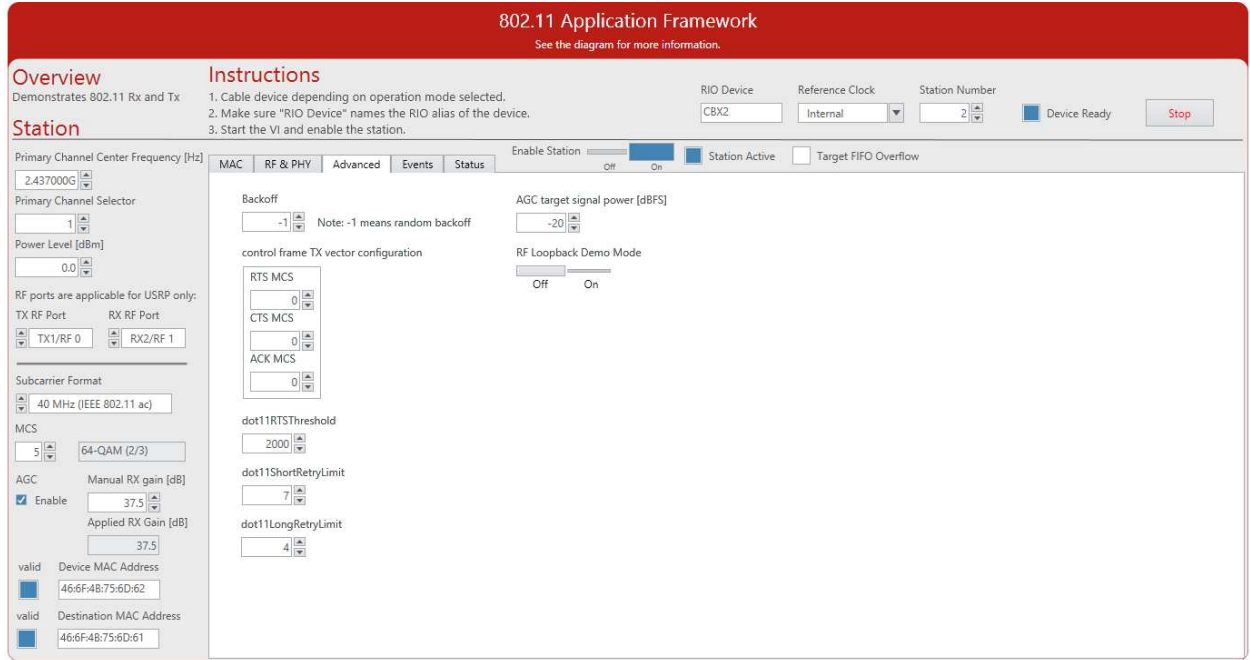

Figure 9 Application Framework Advanced Tab

Static Runtime Settings (Advanced Tab)

Table 10 Static Runtime Settings (Advanced Tab)

Parameter	Description
control frame TX vector configuration	Applies the configured MCS values in TX vectors for RTS, CTS or ACK frames. The default control frame configuration of those frames is Non-HT-OFDM and 20 MHz bandwidth while the MCS can be configured from the host.
dot11RTSThreshold	Semi-static parameter used by frame sequence selection to decide whether RTS CTS is allowed or not. <ul style="list-style-type: none"> If the PSDU length, that is, PN Data Packet Size, is larger than dot11RTSThreshold, the {RTS CTS DATA ACK} frame sequence is used. If the PSDU length, that is, PN Data Packet Size, is less than or equal to the dot11RTSThreshold, the {DATA ACK} frame sequence is used. This mechanism allows stations to be configured to initiate RTS/CTS either always, never, or only on frames longer than a specified length.

dot11ShortRetryLimit	Semi-static parameter—Maximum number of retries applied for short MPDU type (sequences without RTS CTS). If the number of retry limits is reached, discards MPDUs and associated MPDU configuration and TX vector.
dot11LongRetryLimit	Semi-static parameter—Maximum number of retries applied for long MPDU type (sequences including RTS CTS). If the number of retry limits is reached, discards MPDUs and associated MPDU configuration and TX vector.
RF Loopback Demo Mode	Boolean control to switch between the operation modes: RF Multi-Station (Boolean is false): At least two stations are required in the setup, where each station acts as a single 802.11 device. RF Loopback (Boolean is true): A single device is required. This setup is useful for small demos using a single station. However, the implemented MAC features have some limitations in RF Loopback mode. The ACK packets are lost while the MAC TX is waiting for them; the DCF state machine on FPGA of MAC prevents this mode. Therefore, the MAC TX always reports a transmission failed. Hence, the reported TX packet error rate and the TX block error rate on the graphical indication of TX Error Rates are ones.

Dynamic Runtime Settings (Advanced Tab)

Table 11 Dynamic Runtime Settings (Advanced Tab)

Parameter	Description
Backoff	Backoff value that is applied before a frame is transmitted. The backoff is counted in number of slots of 9 μ s duration. Based on the backoff value, the backoff counting for the Backoff procedure could be fixed or random: <ul style="list-style-type: none"> • If the backoff value is larger than or equal zero, a fixed backoff is used. • If the backoff value is negative, a random backoff counting is used.
AGC target signal power	Target RX power in digital base band used if the AGC is enabled. The optimal value depends on the peak to average power ratio (PAPR) of the received signal. Set the AGC target signal power to a value larger than that presented in the Baseband RX Power graph.

Events Tab

The following tables list the controls and indicators that are placed on the Events Tab as it is shown in Figure 10.

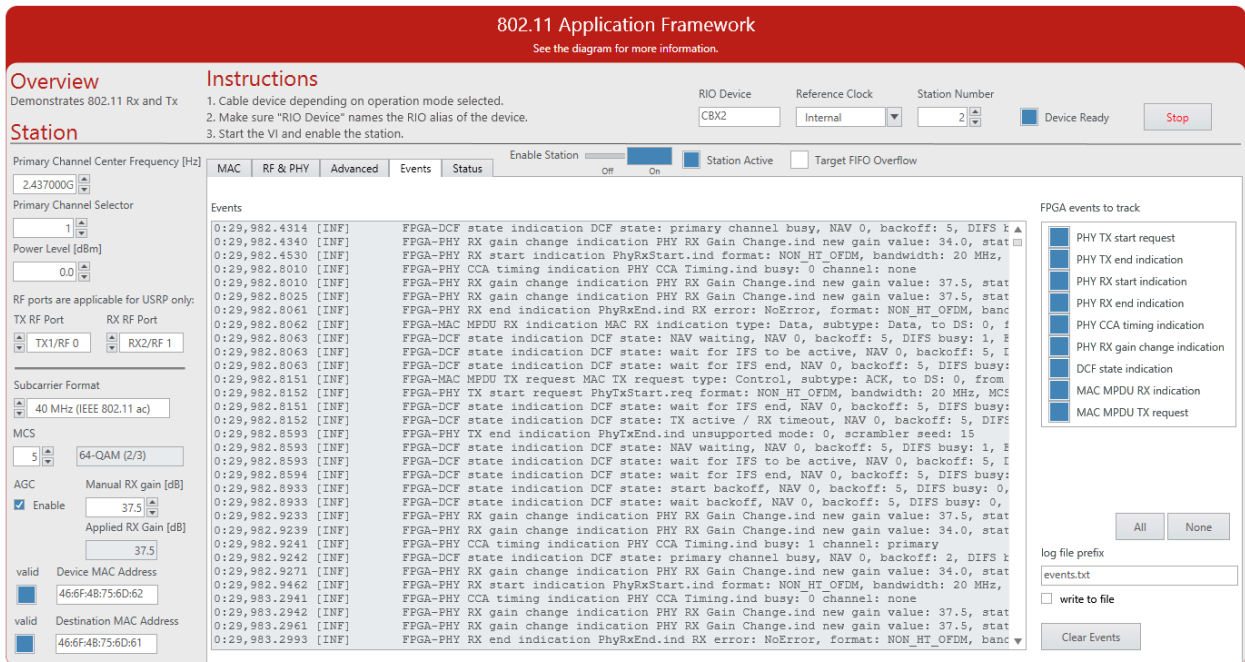

Figure 10 Application Framework Events Tab

Dynamic Runtime Settings (Events Tab)

Table 12 Dynamic Runtime Settings (Events Tab)

Parameter	Description
FPGA events to track	It has a set of Boolean controls; each control is used to enable or disable the tracking of the corresponding FPGA event. Those events are as follows: <ul style="list-style-type: none"> • PHY TX start request • PHY TX end indication • PHY RX start indication • PHY RX end indication • PHY CCA timing indication • PHY RX gain change indication • DCF state indication • MAC MPDU RX indication • MAC MPDU TX request
All	Boolean control to enable the events tracking of the above FPGA events.
None	Boolean control to disable the events tracking of the above FPGA events.
log file prefix	Name a text file to write the FPGA events data that have been read from the Event DMA FIFO. They presented above in the FPGA events to track . Each event consists of a time stamp and the event data. The text file is created locally in the project folder. Only the

	selected events in the FPGA events to track above will be written in the text file.
Write to file	Boolean control to enable or disable the writing process of the selected FPGA events to the text file.
Clear Events	Boolean control to clear the events history from the front panel. The default register size of the events history is 10,000.

Status Tab

The following tables list the indicators that are placed on the Status Tab as it is shown in Figure 11.

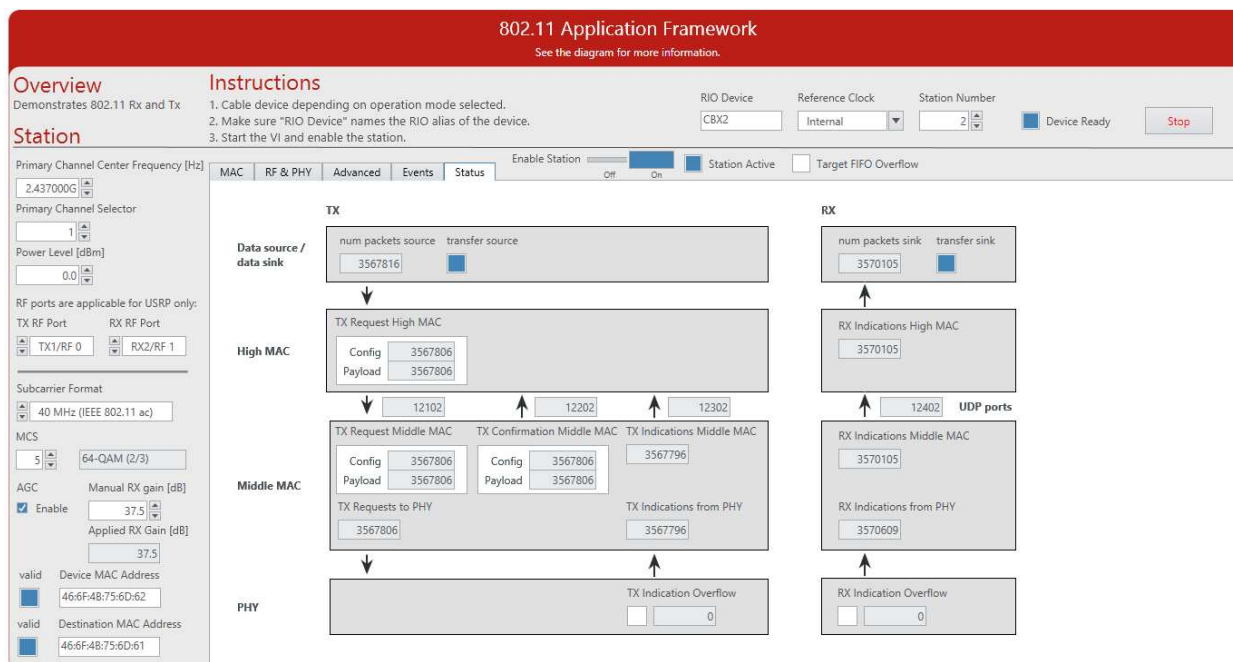

Figure 11 Application Framework Status Tab

Graphs and Indicators (Status Tab)

Table 13 Graphs and Indicators (Status Tab)

Parameter	Description
TX	Presents a number of indicators that are showing the number of messages transferred between different layers, starting from the data source to the PHY. In addition, it shows the corresponding UDP ports.
Data source	num packets source: Numerical indicator shows the number of packets that have been received from the data source (UDP, PN Data, or Manual). transfer source: Boolean indicator shows that a data is receiving from the data source (the number of received packets is not zero).
High MAC	TX Request High MAC: Numerical indicators show the number of MAC TX Configuration and Payload request messages generated by

	the MAC high abstraction layer and written to the corresponding UDP port that is located under them.
Middle MAC	<p>TX Request Middle MAC: Numerical indicators show the number of MAC TX Configuration and Payload request messages received from the MAC high abstraction layer and read from the corresponding UDP port that is located above them. Before transfer both messages to the lower layers, the given configurations are checked if they are supported or not, in addition, the MAC TX Configuration request and MAC TX Payload request are checked if they are consistency.</p> <p>TX Requests to PHY: Numerical indicator shows the number of MAC MSDU TX requests written to the DMA FIFO.</p> <p>TX Confirmation Middle MAC: Numerical indicators show the number of confirmation messages that have been generated by the MAC middle for the MAC TX Configuration and MAC TX Payload messages and written to the assigned UDP port located above them.</p> <p>TX Indications from PHY: Numerical indicator shows the number of MAC MSDU TX end indications read from the DMA FIFO.</p> <p>TX Indications Middle MAC: Numerical indicator shows the number of MAC TX Status Indications reported from MAC Middle to MAC high using the assigned UDP port located above it.</p>
PHY	TX Indications Overflow: Numerical indicator shows the number of overflows that occurred during the FIFO writing by TX End indications.
RX	Presents a number of indicators that are showing the number of messages transferred between different layers, starting from the PHY to data sink. In addition, it shows the corresponding UDP ports.
PHY	RX Indication Overflow: Numerical indicator shows the number of overflows that occurred during the FIFO writing by MAC MSDU RX indications.
Middle MAC	<p>RX Indications from PHY: Numerical indicator shows the number of MAC MSDU RX indications read from the DMA FIFO.</p> <p>RX Indications Middle MAC: Numerical indicator shows the number of MAC MSDU RX indications that have been decoded correctly and reported to the MAC high using the assigned UDP port located above it.</p>
High MAC	RX Indications High MAC: Numerical indicator shows the number of MAC MSDU RX indications with valid MSDU data received at MAC high.
Data sink	<p>num packets sink: Number of received packets at data sink from MAC high.</p> <p>transfer sink: Boolean indicator shows that a data is receiving from the MAC high.</p>

Additional Operation Modes and Configurations Options

This section describes further configuration options and operation modes. In addition to the **RF Multi-Station** mode described in the “Running This Sample Project” section, the 802.11 Application Framework supports the **RF Loopback** and **Baseband** operation modes using a single device. The main steps to run the 802.11 Application Framework using those two modes are described in the following.

RF Loopback Mode (Cabled)

Complete the steps applicable for your configuration.

Configuring the USRP System (RF Loopback Mode)

1. Ensure the USRP device is properly connected to the host system running LabVIEW Communications System Design Suite.
2. Create the RF loopback configuration using one RF cable and an attenuator.
 - a. Connect the cable to RF0/TX1.
 - b. Connect the 30 dB attenuator to the other end of the cable.
 - c. Connect the attenuator to RF1/RX2.
3. Power on the USRP device.
4. Power on the host system.



Figure 12 USRP Hardware Configuration

Configuring the FlexRIO System (RF Loopback Mode)

1. Ensure the FlexRIO device is properly installed in the system running LabVIEW Communications System Design Suite.
2. Create an RF loopback configuration connecting the TX of the NI-5791 module with the RX of the NI-5791 module.

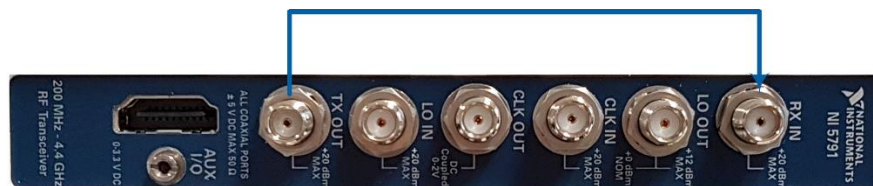

Figure 13 FlexRIO Adapter Module Hardware Configuration

Running the LabVIEW Host Code (RF Loopback Mode)

Instructions about running the LabVIEW host code have already been provided in the “Running This Sample Project” section for the RF Multi-Station operation mode. In addition to the instructions of step 1 in that section, also complete the following steps:

1. The default operation mode is **RF Multi-Station**. Switch to Advanced tab and enable the **RF Loopback Demo Mode** control. This will implement the following changes:
 - The operation mode will be changed to **RF Loopback** mode
 - The **Device MAC Address** and **Destination MAC Address** will get the same address. For example, both could be 46:6F:4B:75:6D:61.
2. Run the LabVIEW host VI by clicking the run button (▶).
 - a. If successful, the **Device Ready** indicator lights.
 - b. If you receive an error, try one of the following:
 - Ensure your device is connected properly.
 - Check the configuration of **RIO Device**.
3. Enable the station by setting the **Enable Station** control to **On**. The **Station Active** indicator should be **on**.
4. To increase the **RX Throughput**, switch to **Advanced** tab and set the backoff value of the backoff procedure to zero, since only one station is running. In addition, set the maximum number of retries of **dot11ShortRetryLimit** to 1. Disable and then enable the station using **Enable Station** control, since the **dot11ShortRetryLimit** is a static parameter.
5. Select the **MAC** tab, and verify the shown RX Constellation matches the modulation and coding scheme configured using the **MCS** and **Subcarrier Format** parameters. For example, 16 QAM is used for MCS 4 and 20 MHz 802.11a. With the default settings you should see a throughput of about 8.2 Mbits/s.

RF Loopback Mode (Over-the-Air Transmission)

Over-the-air transmission is similar to the cabled setup. Cables are replaced by antennas suitable for the selected channel center frequency and system bandwidth.

Notice: Before using your hardware, read all product documentation to ensure compliance with safety, EMC, and environmental regulations.

Baseband Loopback Mode

The baseband loopback is similar to RF loopback. In this mode, the RF is bypassed. TX samples are transferred directly to the RX processing chain on the FPGA. No wiring on the device connectors is needed. To run the station in **Baseband Loopback**, set manually the **operation mode** located in the block diagram as a constant to **Baseband Loopback**.

Additional Configuration Options

PN Data Generator

You can use the built-in pseudonoise (PN) data generator to create TX data traffic, which is useful for measuring the system throughput performance. The PN data generator is configured by the **PN Data Packet Size** and **PN Packets per Second** parameters. The data rate at the output of the PN Data Generator is equal to the product of both parameters. Notice that the actual system throughput seen on RX side depends on the transmission parameters, including the Subcarrier format and the MCS value, and can be lower than the rate generated by the PN data generator.

The following steps provide an example of how the PN data generator can show the impact of the transmission protocol configuration on the achievable throughput. Notice that the given throughput values can be slightly different depending on the actual used hardware platform and channel.

1. Set up, configure, and run two stations (Station A and Station B) such in the “Running This Sample Project” section.
2. Properly adjust the settings for **Device MAC Address** and **Destination MAC Address** such that the device address of Station A is the destination of Station B and vice versa as described previously.
3. On Station B, set **Data Source** to **Manual** to disable TX data from Station B.
4. Enable both stations.
5. With the default settings, you should see a throughput of about 8.2 Mbits/s on Station B.
6. Switch to the **MAC** tab of Station A.
 1. Set the **PN Data Packet Size** to 4061.
 2. Set the number of **PN Packets per Second** to 10,000. This setting saturates the TX buffer for all possible configurations.
7. Switch to the **Advanced** tab of Station A.
 1. Set the **dot11RTSThreshold** to a value larger than the PN Data Packet Size (5,000) to disable RTS/CTS procedure.
 2. Set the maximum number of retries represented by **dot11ShortRetryLimit** to 1 to disable retransmissions.
8. Disable and then enable Station A since the **dot11RTSThreshold** is a static parameter.
9. Try different combinations of Subcarrier Format and MCS on Station A. Observe the changes in RX constellation and RX throughput on Station B.
10. Set Subcarrier Format to 40 MHz (IEEE 802.11ac) and MCS to 7 on Station A. Observe that the throughput on Station B is about 72 Mbits/s.

Video Transmission

Transmitting videos highlights the capabilities of the 802.11 Application Framework. To perform a video transmission with two devices, set up a configuration as described in the previous section. The 802.11 Application Framework provides a UDP interface, which is well suited for video streaming. The transmitter and receiver need a video stream application (for example, VLC, which can be downloaded

from <http://videolan.org>). Any program capable of transmitting UDP data can be used as data source. Similarly, any program capable of receiving UDP data can be used as data sink.

Configure the Receiver

The host acting as a receiver utilizes the 802.11 Application Framework to pass received 802.11 data frames and pass them through UDP to the video stream player.

1. Create a new project as described in “Running the LabVIEW Host Code” and set the correct RIO identifier in the **RIO device** parameter.
2. Set the **Station Number** to 1.
3. Let the **Operation Mode** located in the block diagram to have the default value, **RF Multi Station**, as described previously.
4. Let the **Device MAC Address** and **Destination MAC Address** to have the default values.
5. Switch to **MAC** tab and set **Data Sink** to **UDP**.
6. Enable the station.
7. Start cmd.exe and change to the VLC installation directory.
8. Start the VLC application as a streaming client with the following command:
`vlc udp://@:13000`, where the value 13000 is equal to the **Transmit port of Data Sink Option**.

Configure the Transmitter

The host acting as a transmitter receives UDP packets from the video streaming server and utilizes the 802.11 Application Framework to transmit them as 802.11 data frames.

1. Create a new project as described in “Running the LabVIEW Host Code” and set the correct RIO identifier in the **RIO device** parameter.
2. Set the **Station Number** to 2.
3. Let the **Operation Mode** located in the block diagram to have the default value, **RF Multi Station**, as described previously.
4. Set the **Device MAC Address** to be similar to the **Destination MAC Address** of Station 1 (default value: 46:6F:4B:75:6D:62)
5. Set the **Destination MAC Address** to be similar to the **Device MAC Address** of Station 1 (default value: 46:6F:4B:75:6D:61)
6. Switch to **MAC** tab and set the **Data Source** to **UDP**.
7. Enable the **Station**.
8. Start cmd.exe and change to the VLC installation directory.
9. Identify the path to a video file that shall be used for streaming.
10. Start the VLC application as a streaming server with the following command
`vlc "PATH_TO_VIDEO_FILE"
:sout=#std{access=udp{ttl=1},mux=ts,dst=127.0.0.1:
UDP_Port_Value}`, where *PATH_TO_VIDEO_FILE* should be replaced with the location of the video that should be used, and the parameter *UDP_Port_Value* is equal to 12000 + Station Number, that is, 12002.

The host acting as a receiver will display the video streamed by the transmitter.

Troubleshooting

This section provides information about identifying the root cause of a problem if the system is not working as expected. It is described for a multi-station setup in which Station A and Station B are transmitting.

The following tables provide information about how to verify normal operation and how to detect typical errors.

Table 14 Verifying Normal Operation

Normal Operation	
Normal Operation Test	<ul style="list-style-type: none"> • Set Station Numbers to different values. • Properly adjust the settings of Device MAC Address and Destination MAC Address as described previously. • Leave other settings to the default values. <p>Observations:</p> <ul style="list-style-type: none"> • RX Throughput in the range of 7.5 Mbit/s at both stations. It depends if it is a wireless channel or cabled channel. • On MAC tab: <ul style="list-style-type: none"> ○ MAC TX Statistics: The Data triggered and ACK Triggered indicators are increasing fast. ○ MAC RX Statistics: All indicators are increasing fast rather than the RTS detected and CTS detected, since the dot11RTSthreshold on Advanced tab is larger than PN Data Packet Size (the PSDU length) on MAC tab. ○ The constellation in the RX Constellation graph matches the modulation order of the MCS selected at the transmitter. ○ The TX Block Error Rate graph shows an accepted value. • On RF & PHY tab: <ul style="list-style-type: none"> ○ The RX Power Spectrum is located in the right subband based on the selected Primary Channel Selector. Since the default value is 1, it should be between -20 MHz and 0 in the RX Power Spectrum graph. ○ The CCA Energy Detection Threshold [dBm] is larger than the current power in the RF Input Power graph. ○ The measured baseband power at packet start (red dots) in Baseband RX Power graph should be less than the AGC target signal power on Advanced tab.
MAC Statistics Test	<ul style="list-style-type: none"> • Disable Station A and Station B • On Station A, MAC tab, set the Data Source to Manual. • Enable Station A and Station B <ul style="list-style-type: none"> ○ Station A, MAC tab: <ul style="list-style-type: none"> ▪ Data triggered of MAC TX Statistics is zero. ▪ ACK triggered of MAC RX Statistics is zero. ○ Station B, MAC tab:

	<ul style="list-style-type: none"> ▪ RX Throughput is zero. ▪ ACK triggered of MAC TX Statistics is zero. ▪ Data detected of MAC RX Statistics is zero. • On Station A, MAC tab, click just once on Trigger TX of Manual Data Source <ul style="list-style-type: none"> ○ Station A, MAC tab: <ul style="list-style-type: none"> ▪ Data triggered of MAC TX Statistics is 1. ▪ ACK triggered of MAC RX Statistics is 1. ○ Station B, MAC tab: <ul style="list-style-type: none"> ▪ RX Throughput is zero. ▪ ACK triggered of MAC TX Statistics is 1. ▪ Data detected of MAC RX Statistics is 1.
RTS / CTS counters Test	<ul style="list-style-type: none"> • Disable Station A, set the dot11RTSThreshold to zero, since it is a static parameter. Then, enable Station A. • On Station A, MAC tab, click just once on Trigger TX of Manual Data Source <ul style="list-style-type: none"> ○ Station A, MAC tab: <ul style="list-style-type: none"> ▪ RTS triggered of MAC TX Statistics is 1. ▪ CTS triggered of MAC RX Statistics is 1. ○ Station B, MAC tab: <ul style="list-style-type: none"> ▪ CTS triggered of MAC TX Statistics is 1. ▪ RTS triggered of MAC RX Statistics is 1.

Table 15 Detecting Typical Errors

Wrong Configuration	
System Configuration	<ul style="list-style-type: none"> • Set Station Numbers to different values. • Properly adjust the settings of Device MAC Address and Destination MAC Address as described previously. • Leave other settings to the default values.
Error: No data provided for transmission	<p>Indication: The counter values of Data triggered and ACK triggered in MAC TX Statistics are not increased.</p> <p>Solution: Set Data Source to PN Data. Alternatively, set Data Source to UDP and make sure that you use an external application to provide data to the UDP port configured correctly as described in the previous.</p>
Error: MAC TX considers the medium as busy	<p>Indication: The MAC Statistics values of Data Triggered and preamble detected, part of MAC TX Statistics and MAC RX Statistics, respectively, are not increased.</p> <p>Solution: Check the values of the curve current in the RF Input Power graph. Set the CCA Energy Detection Threshold [dBm] control to a value which is higher than the minimal value of this curve.</p>
Error: Send more data packets than the MAC can Provide to the PHY	<p>Indication: The PN Data Packet Size and the PN Packets Per Second are increased. However, the achieved throughput is not increased.</p> <p>Solution: Choose a higher MCS value and higher Subcarrier Format.</p>

Error: wrong RF ports	Indication: The RX Power Spectrum does not show the same curve as the TX Power Spectrum on the other station. Solution: Verify that you have the cables or antennas connected to the RF ports which you have configured as TX RF Port and RX RF Port .
Error: MAC address mismatch	Indication: On Station B, no ACK packet transmission is triggered (part of MAC TX Statistics) and the RX Throughput is zero. Solution: Check that Device MAC Address of Station B matches the Destination MAC Address of Station A. For RF Loopback mode, both Device MAC Address and Destination MAC Address should have the same address, for example 46:6F:4B:75:6D:61.
Error: High CFO if Station A and B are FlexRIOs	Indication: The compensated CFO is high, which degrades the whole performance of the network. Solution: Set the Reference Clock to PXI_CLK or REF IN/CkIn. <ul style="list-style-type: none"> For PXI_CLK: The reference is taken from the PXI chassis. REF IN/CkIn: The reference is taken from the CkIn port of NI-5791.
TX Error Rates are one in RF Loopback or Baseband Loopback operation modes	Indication: A single station is used where the operation mode is configured to RF Loopback or Baseband Loopback mode. The graphical indication of TX Error Rates shows 1. Solution: This behavior is expected. The ACK packets are lost while the MAC TX is waiting for them; the DCF state machine on FPGA of MAC prevents this in case of RF loopback or Baseband Loopback modes. Therefore, the MAC TX always reports a transmission failed. Hence, the reported TX packet error rate and the TX block error rate are zeros.

Known Issues

Make sure the USRP device is already running and connected to the host before the host is started. Otherwise the USRP device may not be properly recognized by the host.

Visit ni.com/info and enter the Info Code [ex54ev](#) to access the known issues for 802.11 Application Framework 2.2.

Related Information

- Refer to ni.com/manuals to access the getting started guide for your hardware.
- Visit ni.com/info and enter the Info Code [80211AppFWManual](#) to access the *LabVIEW Communications 802.11 Application Framework Manual* for more information about the 802.11 Application Framework design.
- Visit ni.com/info and enter the Info Code [commsmanual](#) to access the *LabVIEW Communications System Design Suite Manual* for information about LabVIEW concepts or objects used in this sample project.
- You also can use the **Context Help** window to learn basic information about LabVIEW objects as you move the cursor over each object. To display the **Context Help** window in LabVIEW, select **View»Context Help**.
- [IEEE Standards Association: 802.11 Wireless LANs](#)

Acronyms

Acronym	Meaning
ACK	Acknowledgement
AGC	Automatic gain control
A-MPDU	Aggregated MPDU
CCA	Clear channel assessment
CFO	Carrier frequency offset
CSMA/CA	Carrier sense multiple access with collision avoidance
CTS	Clear-to-send
CW	Continuous wave
DAC	Digital to analog converter
DCF	Distributed coordination function
DMA	Direct memory access
FCS	Frame check sequence
FIFO	First-in-first-out memory buffer
HT	High-throughput
I/Q	In-phase/quadrature
MAC	Medium access control layer
MCS	Modulation and coding scheme
MIMO	Multiple-input-multiple-output
MPDU	MAC protocol data unit
NAV	Network allocation vector
OFDM	Orthogonal frequency-division multiplexing
PAPR	Peak to average power ratio
PHY	Physical layer
PLCP	Physical layer convergence procedure
PN	Pseudo noise
PSDU	PHY service data unit
QAM	Quadrature amplitude modulation
RTS	Request-to-send
RX	Receive
SIFS	Short interframe spacing
SISO	Single input single output
T2H	Target to host
TX	Transmit
UDP	User datagram protocol

Refer to the *NI Trademarks and Logo Guidelines* at ni.com/trademarks for more information on NI trademarks. Other product and company names mentioned herein are trademarks or trade names of their respective companies. For patents covering NI products/technology, refer to the appropriate location: **Help»Patents** in your software, the `patents.txt` file on your media, or the *National Instruments Patents Notice* at ni.com/patents. You can find information about end-user license agreements (EULAs) and third-party legal notices in the readme file for your NI product. Refer to the *Export Compliance Information* at ni.com/legal/export-compliance for the NI global trade compliance policy and how to obtain relevant HTS codes, ECCNs, and other import/export data. NI MAKES NO EXPRESS OR IMPLIED WARRANTIES AS TO THE ACCURACY OF THE INFORMATION CONTAINED HEREIN AND SHALL NOT BE LIABLE FOR ANY ERRORS. U.S. Government Customers: The data contained in this manual was developed at private expense and is subject to the applicable limited rights and restricted data rights as set forth in FAR 52.227-14, DFAR 252.227-7014, and DFAR 252.227-7015.

© 2015-2018 National Instruments. All rights reserved.