

## COMPREHENSIVE SERVICES

We offer competitive repair and calibration services, as well as easily accessible documentation and free downloadable resources.

## SELL YOUR SURPLUS

We buy new, used, decommissioned, and surplus parts from every NI series. We work out the best solution to suit your individual needs.

 Sell For Cash    Get Credit    Receive a Trade-In Deal

## OBSOLETE NI HARDWARE IN STOCK & READY TO SHIP

We stock **New**, **New Surplus**, **Refurbished**, and **Reconditioned** NI Hardware.



*Bridging the gap between the manufacturer and your legacy test system.*

 1-800-915-6216

 [www.apexwaves.com](http://www.apexwaves.com)

 [sales@apexwaves.com](mailto:sales@apexwaves.com)

*All trademarks, brands, and brand names are the property of their respective owners.*

**Request a Quote**

 **CLICK HERE**

**PXIe-3610**

# mmWave Transceiver System

## 2 GHz Bandwidth mmWave Transceiver System

This document explains how to install and configure the National Instruments millimeter wave (mmWave) Transceiver System. The mmWave Transceiver System is a modular set of hardware that can be used in various communications applications. This system ships with the NI-mmWave instrument driver, which you can use to program the system.



**Caution** Observe all instructions and cautions in the user documentation. Using the model in a manner not specified can damage the model and compromise the built-in safety protection. Return damaged models to NI for repair.



**Attention** Suivez toutes les instructions et respectez toutes les mises en garde de la documentation utilisateur. L'utilisation d'un modèle de toute autre façon que celle spécifiée risque de l'endommager et de compromettre la protection de sécurité intégrée. Renvoyez les modèles endommagés à NI pour réparation.



**Caution** If the device has been in use, it may exceed safe handling temperatures and cause burns. Allow the device to cool before removing it from the chassis.



**Attention** Si l'appareil a été utilisé, il peut avoir atteint des températures trop élevées pour être manipulé en toute sécurité, ce qui peut provoquer des brûlures. Laissez l'appareil refroidir avant de le retirer du châssis.



**Caution** The system installation must adequately protect users' eyes from exposure to millimeter wave radiation output and input signals from the transmitter and receiver.



**Attention** L'installation du système doit protéger correctement les yeux des utilisateurs contre l'exposition aux rayonnements d'ondes millimétriques des signaux en entrée et en sortie provenant de l'émetteur et du récepteur.

## Contents

---

|                                                            |   |
|------------------------------------------------------------|---|
| Verifying the System Requirements.....                     | 2 |
| Unpacking the Kit.....                                     | 2 |
| System Configurations with mmWave Radio Heads.....         | 4 |
| Installing the Software.....                               | 7 |
| Assembling mmWave Radio Head Tripods (mmRH-3647/3657)..... | 7 |

|                                                                     |    |
|---------------------------------------------------------------------|----|
| System Setup.....                                                   | 10 |
| Unidirectional System Setup.....                                    | 10 |
| Bidirectional System Setup.....                                     | 27 |
| Connecting mmWave Radio Heads to the System.....                    | 38 |
| Configuring the Coding Modules of a MIMO System.....                | 50 |
| Programming the mmWave Transceiver System.....                      | 57 |
| NI-mmWave Instrument Driver.....                                    | 57 |
| Trigger Configuration.....                                          | 57 |
| Signal Block Diagrams.....                                          | 59 |
| 24.25 GHz to 33.40 GHz mmWave Transceiver System Block Diagram..... | 59 |
| 37 GHz to 43.5 GHz mmWave Transceiver System Block Diagram.....     | 59 |
| 71 GHz to 76 GHz mmWave Transceiver System Block Diagram.....       | 60 |
| Front Panels, Back Panels, and Connectors.....                      | 60 |
| Direct Connections to the mmWave Transceiver System.....            | 60 |
| PXIe-3610 Front Panel and LEDs.....                                 | 61 |
| PXIe-3620 Front Panel.....                                          | 63 |
| PXIe-3630 Front Panel and LEDs.....                                 | 65 |
| PXIe-7902 Front Panel.....                                          | 67 |
| mmRH-3602 Front/Back Panel and LEDs.....                            | 68 |
| mmRH-3603 Front/Back Panel and LEDs.....                            | 71 |
| mmRH-3642 Front/Back Panel and LEDs.....                            | 74 |
| mmRH-3643 Front/Back Panel and LEDs.....                            | 76 |
| mmRH-3647 Front/Back Panel and LEDs.....                            | 78 |
| mmRH-3652 Front/Back Panel and LEDs.....                            | 80 |
| mmRH-3653 Front/Back Panel and LEDs.....                            | 82 |
| mmRH-3657 Front/Back Panel and LEDs.....                            | 84 |
| Where to Go Next.....                                               | 85 |

## Verifying the System Requirements

---

To use the NI-mmWave instrument driver, your system must meet certain requirements.

Refer to the product readme, which is available online at [ni.com/manuals](http://ni.com/manuals), for more information about minimum system requirements, recommended system, and supported application development environments (ADEs).

## Unpacking the Kit

---

Each mmWave Transceiver System configuration includes chassis, modules, and cables. Additional chassis, devices, and cables may be included depending on added options.

**Table 1. Kit Contents by Configuration**

| <b>Configuration</b>                                             | <b>Required</b>                                                                                                                                                                             | <b>MIMO Coding Option</b>                                                                                                       |
|------------------------------------------------------------------|---------------------------------------------------------------------------------------------------------------------------------------------------------------------------------------------|---------------------------------------------------------------------------------------------------------------------------------|
| Unidirectional single input, single output (SISO) (baseband)     | <ul style="list-style-type: none"> <li>Receiver (RX) chassis</li> <li>Transmitter (TX) chassis</li> <li>Mini-SAS HD(m)-to-Mini-SAS HD(m) (8.25 in.) cables (x9)</li> </ul>                  | —                                                                                                                               |
| Unidirectional SISO (baseband and intermediate frequency (IF))   | <ul style="list-style-type: none"> <li>RX chassis</li> <li>TX chassis</li> <li>Mini-SAS HD(m)-to-Mini-SAS HD(m) (8.25 in.) cables (x9)</li> <li>MMPX(m)-to-MMPX(m) cables (x8)</li> </ul>   | —                                                                                                                               |
| Unidirectional multiple-input, multiple-output (MIMO) (baseband) | <ul style="list-style-type: none"> <li>RX chassis</li> <li>TX chassis</li> <li>Mini-SAS HD(m)-to-Mini-SAS HD(m) (8.25 in.) cables (x19)</li> </ul>                                          | <ul style="list-style-type: none"> <li>Coding chassis</li> <li>Mini-SAS HD(m)-to-Mini-SAS HD(m) (18 in.) cables (x2)</li> </ul> |
| Unidirectional MIMO (baseband and IF)                            | <ul style="list-style-type: none"> <li>RX chassis</li> <li>TX chassis</li> <li>Mini-SAS HD(m)-to-Mini-SAS HD(m) (8.25 in.) cables (x19)</li> <li>MMPX(m)-to-MMPX(m) cables (x16)</li> </ul> | <ul style="list-style-type: none"> <li>Coding chassis</li> <li>Mini-SAS HD(m)-to-Mini-SAS HD(m) (18 in.) cables (x2)</li> </ul> |
| Bidirectional SISO (baseband)                                    | <ul style="list-style-type: none"> <li>RX/TX chassis (x2)</li> <li>Mini-SAS HD(m)-to-Mini-SAS HD(m) (8.25 in.) cables (x18)</li> </ul>                                                      | —                                                                                                                               |
| Bidirectional SISO (baseband and IF)                             | <ul style="list-style-type: none"> <li>RX/TX chassis (x2)</li> <li>Mini-SAS HD(m)-to-Mini-SAS HD(m) (8.25 in.) cables (x18)</li> <li>MMPX(m)-to-MMPX(m) cables (x16)</li> </ul>             | —                                                                                                                               |

**Table 1. Kit Contents by Configuration (Continued)**

| <b>Configuration</b>                 | <b>Required</b>                                                                                                                                                                      | <b>MIMO Coding Option</b>                                                                                                                |
|--------------------------------------|--------------------------------------------------------------------------------------------------------------------------------------------------------------------------------------|------------------------------------------------------------------------------------------------------------------------------------------|
| Bidirectional MIMO (baseband)        | <ul style="list-style-type: none"> <li>• RX/TX chassis (x2)</li> <li>• Mini-SAS HD(m)-to-Mini-SAS HD(m) (8.25 in.) cables (x38)</li> </ul>                                           | <ul style="list-style-type: none"> <li>• Coding chassis (x2)</li> <li>• Mini-SAS HD(m)-to-Mini-SAS HD(m) (18 in.) cables (x4)</li> </ul> |
| Bidirectional MIMO (baseband and IF) | <ul style="list-style-type: none"> <li>• RX/TX chassis (x2)</li> <li>• Mini-SAS HD(m)-to-Mini-SAS HD(m) (8.25 in.) cables (x38)</li> <li>• MMPX(m)-to-MMPX(m) cable (x32)</li> </ul> | <ul style="list-style-type: none"> <li>• Coding chassis (x2)</li> <li>• Mini-SAS HD(m)-to-Mini-SAS HD(m) (18 in.) cables (x4)</li> </ul> |

## System Configurations with mmWave Radio Heads

You can choose to connect your system to a selection of the following mmWave radio heads:

- mmRH-3602 mmWave Radio Head
- mmRH-3603 mmWave Radio Head
- mmRH-3642 mmWave Radio Head
- mmRH-3643 mmWave Radio Head
- mmRH-3647 mmWave Radio Head
- mmRH-3652 mmWave Radio Head
- mmRH-3653 mmWave Radio Head
- mmRH-3657 mmWave Radio Head

**Table 2.** Unidirectional System Configurations with mmWave Radio Heads

| <b>Configuration</b>                  | <b>mmRH-3642/3643/3652/3653</b>                                                                                                                                                                                                                                               | <b>mmRH-3602/3603</b> | <b>mmRH-3647/3657</b>                                                                                                                                                                                                      |
|---------------------------------------|-------------------------------------------------------------------------------------------------------------------------------------------------------------------------------------------------------------------------------------------------------------------------------|-----------------------|----------------------------------------------------------------------------------------------------------------------------------------------------------------------------------------------------------------------------|
| Unidirectional SISO (baseband)        | —                                                                                                                                                                                                                                                                             | —                     | —                                                                                                                                                                                                                          |
| Unidirectional SISO (baseband and IF) | <ul style="list-style-type: none"> <li>• mmRH-3642/3643</li> <li>• mmRH-3652/3653</li> <li>• Single-channel EPLSP cables (x2)</li> <li>• Digital I/O (DIO) adapters (x2)</li> <li>• HDMI(m)-to-mini-HDMI(m) cables (x2)</li> <li>• SMA(m)-to-SMA(m) cables (x4)</li> </ul>    | —                     | <ul style="list-style-type: none"> <li>• mmRH-3647</li> <li>• mmRH-3657</li> <li>• mmWave radio head tripods (x2)</li> <li>• Single-channel EPLSP cables (x2)</li> <li>• SMA(m)-to-SMA(m) cables (x4)</li> </ul>           |
| Unidirectional MIMO (baseband)        | —                                                                                                                                                                                                                                                                             | —                     | —                                                                                                                                                                                                                          |
| Unidirectional MIMO (baseband and IF) | <ul style="list-style-type: none"> <li>• mmRH-3642/3643 (x2)</li> <li>• mmRH-3652/3653 (x2)</li> <li>• Single-channel EPLSP cables (x4)</li> <li>• DIO adapter modules (x4)</li> <li>• HDMI(m)-to-mini-HDMI(m) cables (x4)</li> <li>• SMA(m)-to-SMA(m) cables (x8)</li> </ul> | —                     | <ul style="list-style-type: none"> <li>• mmRH-3647 (x2)</li> <li>• mmRH-3657 (x2)</li> <li>• mmWave radio head tripods (x4)</li> <li>• Single-channel EPLSP cables (x4)</li> <li>• SMA(m)-to-SMA(m) cables (x8)</li> </ul> |

**Table 3.** Bidirectional System Configurations with mmWave Radio Heads

| <b>Configuration</b>                 | <b>mmRH-3642/3643/3652/3653</b>                                                                                                                                                                                                                                              | <b>mmRH-3602/3603</b>                                                                                                                                                                                                                           | <b>mmRH-3647/3657</b>                                                                                                                                                                                                     |
|--------------------------------------|------------------------------------------------------------------------------------------------------------------------------------------------------------------------------------------------------------------------------------------------------------------------------|-------------------------------------------------------------------------------------------------------------------------------------------------------------------------------------------------------------------------------------------------|---------------------------------------------------------------------------------------------------------------------------------------------------------------------------------------------------------------------------|
| Bidirectional SISO (baseband)        | —                                                                                                                                                                                                                                                                            | —                                                                                                                                                                                                                                               | —                                                                                                                                                                                                                         |
| Bidirectional SISO (baseband and IF) | <ul style="list-style-type: none"> <li>• mmRH-3642/3643 (x2)</li> <li>• mmRH-3652/3653 (x2)</li> <li>• Dual-channel EPLSP cables (x2)</li> <li>• DIO adapter modules (x4)</li> <li>• HDMI(m)-to-mini-HDMI(m) cables (x4)</li> <li>• SMA(m)-to-SMA(m) cables (x8)</li> </ul>  | <ul style="list-style-type: none"> <li>• mmRH-3602/3603 (x2)</li> <li>• Single-channel EPLSP cables (x2)</li> <li>• DIO adapter modules (x2)</li> <li>• HDMI(m)-to-mini-HDMI(m) cables (x2)</li> <li>• SMA(m)-to-SMA(m) cables (x8)</li> </ul>  | <ul style="list-style-type: none"> <li>• mmRH-3647 (x2)</li> <li>• mmRH-3657 (x2)</li> <li>• mmWave radio head tripods (x4)</li> <li>• Dual-channel EPLSP cables (x4)</li> <li>• SMA(m)-to-SMA(m) cables (x8)</li> </ul>  |
| Bidirectional MIMO (baseband)        | —                                                                                                                                                                                                                                                                            | —                                                                                                                                                                                                                                               | —                                                                                                                                                                                                                         |
| Bidirectional MIMO (baseband and IF) | <ul style="list-style-type: none"> <li>• mmRH-3642/3643 (x4)</li> <li>• mmRH-3652/3653 (x4)</li> <li>• Dual-channel EPLSP cables (x4)</li> <li>• DIO adapter modules (x8)</li> <li>• HDMI(m)-to-mini-HDMI(m) cables (x8)</li> <li>• SMA(m)-to-SMA(m) cables (x16)</li> </ul> | <ul style="list-style-type: none"> <li>• mmRH-3602/3603 (x4)</li> <li>• Single-channel EPLSP cables (x4)</li> <li>• DIO adapter modules (x4)</li> <li>• HDMI(m)-to-mini-HDMI(m) cables (x4)</li> <li>• SMA(m)-to-SMA(m) cables (x16)</li> </ul> | <ul style="list-style-type: none"> <li>• mmRH-3647 (x4)</li> <li>• mmRH-3657 (x4)</li> <li>• mmWave radio head tripods (x8)</li> <li>• Dual-channel EPLSP cables (x8)</li> <li>• SMA(m)-to-SMA(m) cables (x16)</li> </ul> |

You can simultaneously connect different models of mmWave radio heads to the mmWave Transceiver System. However, connecting models with different IF frequency ranges, such as the mmRH-3642 and the mmRH-3647, may cause a non-ideal IF frequency to be used.

### Related Information

*Refer to the [mmWave Transceiver System Specifications on ni.com](#) for IF frequency ranges by model.*

## Installing the Software

---

You must be an Administrator to install NI software on your computer.

1. Install an ADE, such as LabVIEW.
2. Install NI LabVIEW FPGA Module.
3. (Recommended) Install the latest service pack for LabVIEW and any LabVIEW modules you are using.
4. Visit [ni.com/info](#) and enter the Info Code `mmwavedriver` to access the driver download page for the latest NI-mmWave software.
5. Download the NI-mmWave driver software.
6. Run `setup.exe`.
7. Follow the instructions in the installation prompts.



**Note** Windows users may see access and security messages during installation. Accept the prompts to complete the installation.

8. When the installer completes, select **Restart** in the dialog box that prompts you to restart, shut down, or restart later.

### Related Information

*[Programming the mmWave Transceiver System](#) on page 57*

## Assembling mmWave Radio Head Tripods (mmRH-3647/3657)

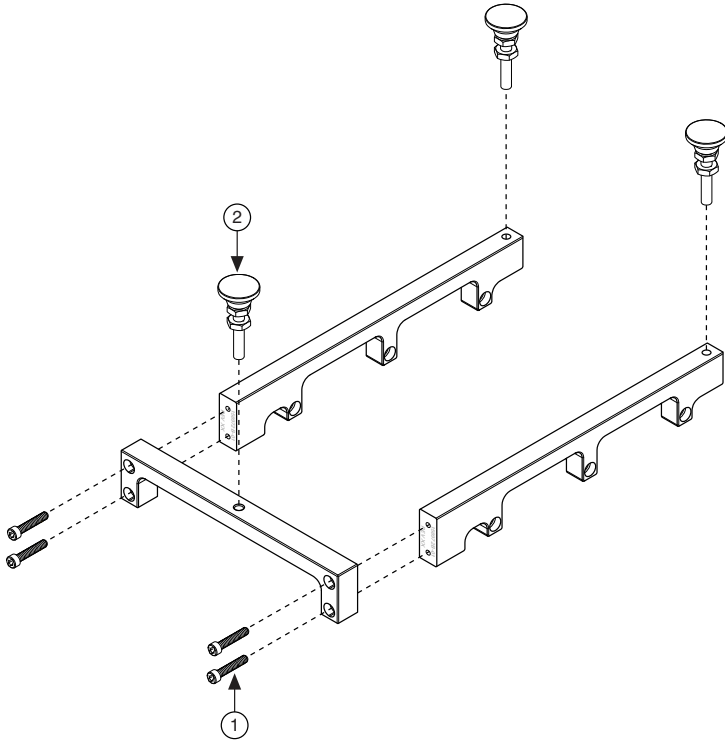
---

Complete the following steps to assemble the mmWave radio head tripods if your configuration includes mmWave radio heads and tripod stability is desired.

1. Install four 3/4 in. screws as shown in the following figure. Do not tighten.



**Figure 1. Assembling the Tripod**



1. 3/4 in. Screws
2. Stud Leveling Feet

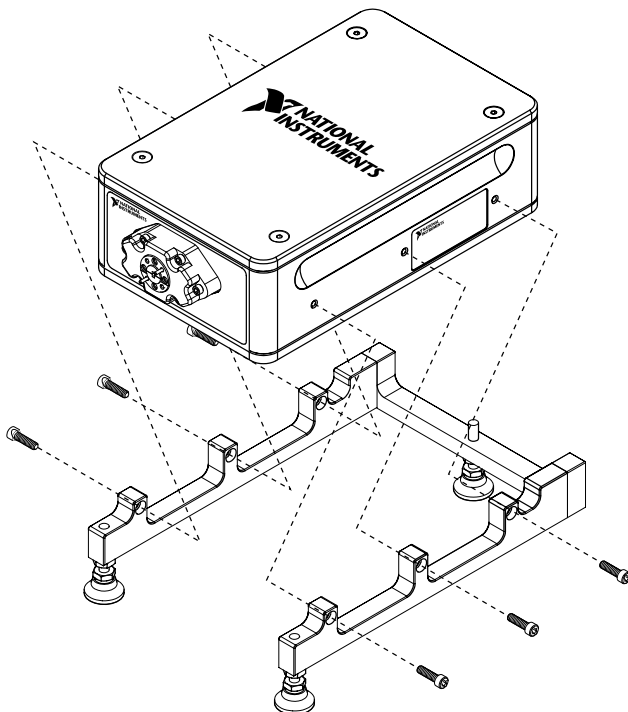
2. Install three stud leveling feet as shown in the previous figure and use to adjust the mmWave radio head to the desired mounting height. Jam nuts may be tightened to lock height adjustment according to the specifications in the following table.

**Table 4. Tightening Requirements for mmWave Radio Head Tripods**

| Item                       | Max Torque (in. x lb) | Driver Size  |
|----------------------------|-----------------------|--------------|
| 3/4 in. and 1/2 in. screws | 11.5                  | 7/64 in. hex |
| Stud leveling foot jam nut | 11.5                  | 3/8 in. hex  |

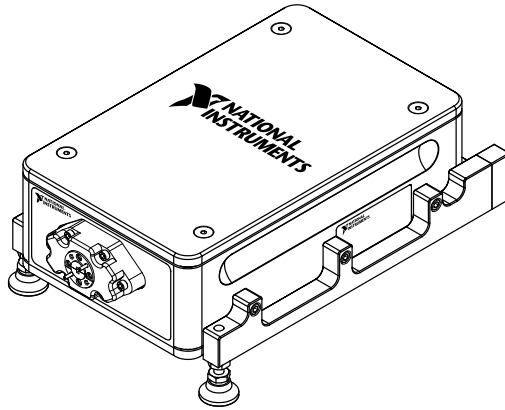
3. Install the mmWave radio head using six 1/2 in. screws as shown in the following figure and tighten them according to the specifications in Table 4.

**Figure 2.** Assembling the Tripod with the mmWave Radio Head



4. Tighten the 3/4 in. screws according to the specifications in Table 4.

**Figure 3.** Completed Tripod and mmWave Radio Head Assembly



### Related Information

[Connecting mmRH-3647/3657 Radio Heads to a Bidirectional System](#) on page 49

[Connecting mmRH-3647/3657 Radio Heads to a Unidirectional System](#) on page 42

## System Setup

This section describes how to connect the modules of your mmWave Transceiver System.

The mmWave Transceiver System modules arrive pre-installed in the chassis.



**Notice** Modifying or reserving system-required PXI triggers will cause runtime synchronization errors and prohibit system function.

### Related Information

[Trigger Configuration](#) on page 57

[Refer to the NI-mmWave Manual on ni.com for more information about trigger routing.](#)

## Unidirectional System Setup

This section describes how to connect the modules of a unidirectional mmWave Transceiver System.

Unidirectional mmWave Transceiver System configurations are as follows:

- Unidirectional SISO (baseband)
- Unidirectional SISO (baseband and IF)
- Unidirectional MIMO (baseband)
- Unidirectional MIMO (baseband and IF)

Each configuration consists of two chassis, identical except for the unique components listed in the following table.

**Table 5.** Unique Components of Unidirectional System Chassis

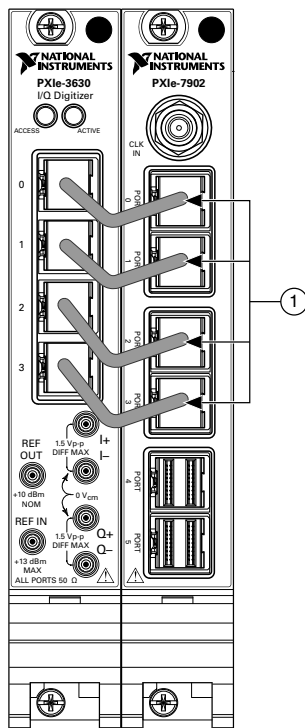
| <b>Chassis</b> | <b>Unique Component</b>      |
|----------------|------------------------------|
| RX             | PXIe-3630 Digitizer          |
| TX             | PXIe-3610 Waveform Generator |

## Interconnecting the Unidirectional SISO (Baseband) Modules

Complete the following steps to connect the modules of the unidirectional SISO (baseband) mmWave Transceiver System configuration.

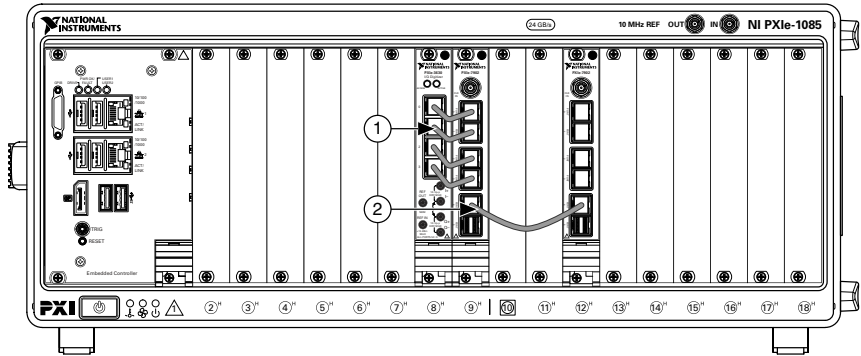
1. Connect the adjoining PXIe-3630 and PXIe-7902 High-Speed Serial Instrument modules in the RX chassis using four Mini-SAS HD(m)-to-Mini-SAS HD(m) (8.25 in.) cables.
  - a) Connect the 0 connector of the PXIe-3630 front panel to the PORT 0 connector of the PXIe-7902 front panel.
  - b) Connect the 1 connector of the PXIe-3630 front panel to the PORT 1 connector of the PXIe-7902 front panel.
  - c) Connect the 2 connector of the PXIe-3630 front panel to the PORT 2 connector of the PXIe-7902 front panel.
  - d) Connect the 3 connector of the PXIe-3630 front panel to the PORT 3 connector of the PXIe-7902 front panel.

**Figure 4.** Interconnecting the PXIe-3630 and PXIe-7902 Modules



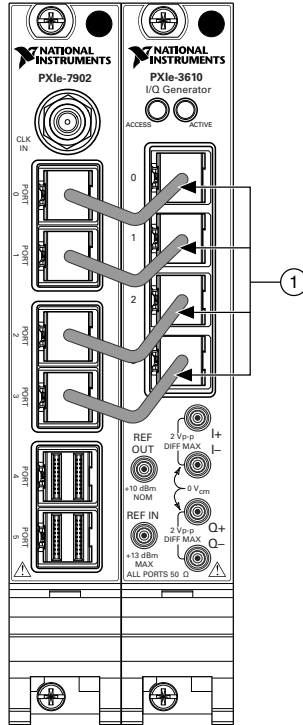
1. Mini-SAS HD(m)-to-Mini-SAS HD(m) (8.25 in.) Cables
2. Connect the PORT 4 connector of the PXIe-7902 front panel to the PORT 4 connector of the PXIe-7902 front panel using a Mini-SAS HD(m)-to-Mini-SAS HD(m) (8.25 in.) cable.

**Figure 5.** Unidirectional SISO (Baseband) RX Chassis



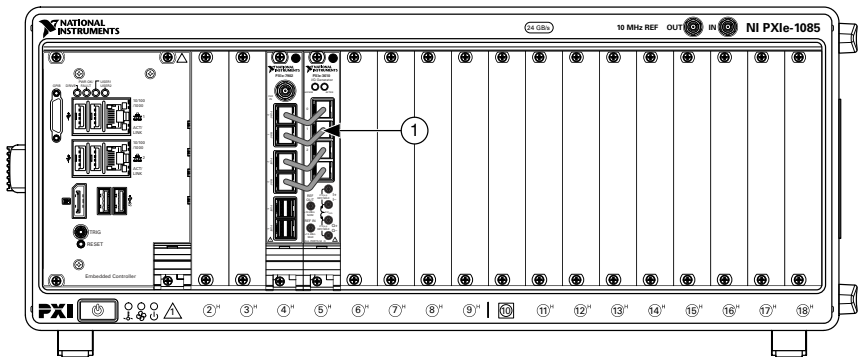
1. Mini-SAS HD(m)-to-Mini-SAS HD(m) (8.25 in.) Cables
  2. Mini-SAS HD(m)-to-Mini-SAS HD(m) (8.25 in.) Cable
- 
3. Connect the adjoining PXIe-7902 and PXIe-3610 modules in the TX chassis using four Mini-SAS HD(m)-to-Mini-SAS HD(m) (8.25 in.) cables.
    - a) Connect the PORT 0 connector of the PXIe-7902 front panel to the 0 connector of the PXIe-3610 front panel.
    - b) Connect the PORT 1 connector of the PXIe-7902 front panel to the 1 connector of the PXIe-3610 front panel.
    - c) Connect the PORT 2 connector of the PXIe-7902 front panel to the 2 connector of the PXIe-3610 front panel.
    - d) Connect the PORT 3 connector of the PXIe-7902 front panel to the 3 connector of the PXIe-3610 front panel.

**Figure 6.** Interconnecting the PXIe-7902 and PXIe-3610 Modules



1. Mini-SAS HD(m)-to-Mini-SAS HD(m) (8.25 in.) Cables

**Figure 7.** Unidirectional SISO (Baseband) TX Chassis



1. Mini-SAS HD(m)-to-Mini-SAS HD(m) (8.25 in.) Cables

Disconnect cables or otherwise attenuate the signal to ensure that no signal is entering the baseband ports on the PXIe-3630 module during system startup.

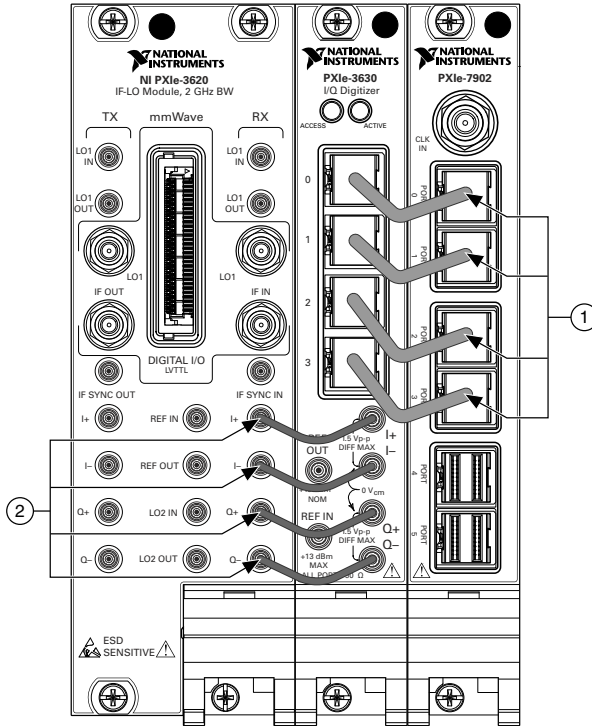
## Interconnecting the Unidirectional SISO (Baseband and IF) Modules

Complete the following steps to connect the modules of the unidirectional SISO (baseband and IF) mmWave Transceiver System configuration.

1. Connect the adjoining PXIe-3620 RF Upconverter and Downconverter Module and PXIe-3630 modules in the RX chassis using four MMPX(m)-to-MMPX(m) cables.
  - a) Connect the RX I+ connector of the PXIe-3620 front panel to the I+ connector of the PXIe-3630 front panel.
  - b) Connect the RX I– connector of the PXIe-3620 front panel to the I– connector of the PXIe-3630 front panel.
  - c) Connect the RX Q+ connector of the PXIe-3620 front panel to the Q+ connector of the PXIe-3630 front panel.
  - d) Connect the RX Q– connector of the PXIe-3620 front panel to the Q– connector of the PXIe-3630 front panel.
2. Connect the adjoining PXIe-3630 and PXIe-7902 modules in the RX chassis using four Mini-SAS HD(m)-to-Mini-SAS HD(m) (8.25 in.) cables.
  - a) Connect the 0 connector of the PXIe-3630 front panel to the PORT 0 connector of the PXIe-7902 front panel.
  - b) Connect the 1 connector of the PXIe-3630 front panel to the PORT 1 connector of the PXIe-7902 front panel.
  - c) Connect the 2 connector of the PXIe-3630 front panel to the PORT 2 connector of the PXIe-7902 front panel.
  - d) Connect the 3 connector of the PXIe-3630 front panel to the PORT 3 connector of the PXIe-7902 front panel.

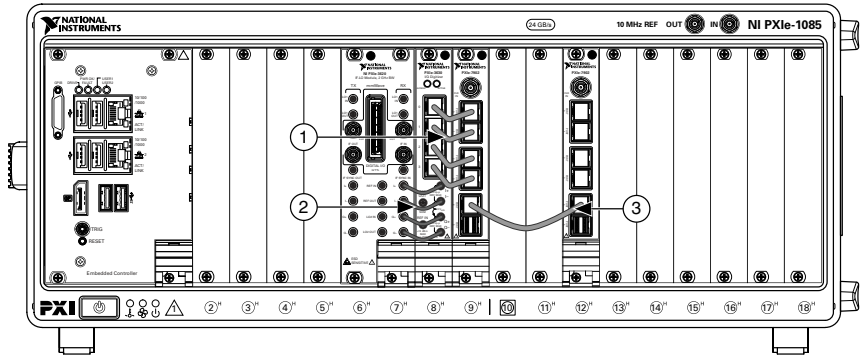


**Figure 8.** Interconnecting the PXIe-3620, PXIe-3630, and PXIe-7902 Modules



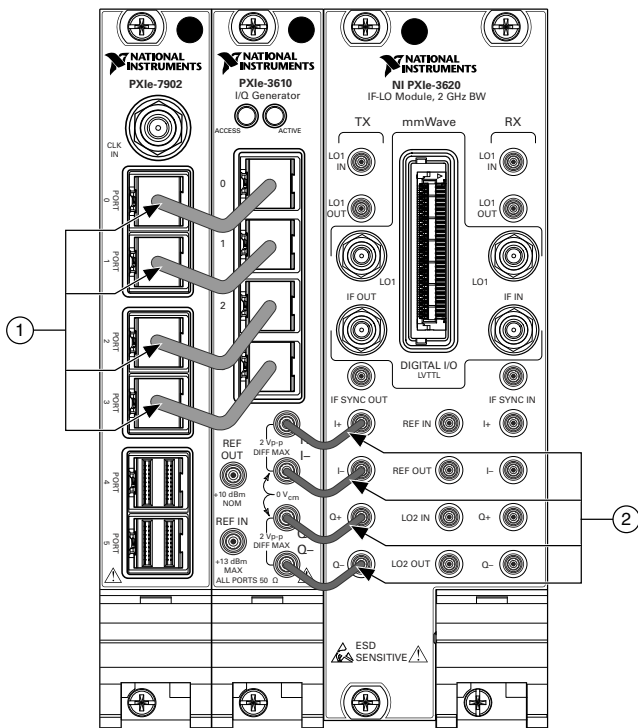
1. Mini-SAS HD(m)-to-Mini-SAS HD(m) (8.25 in.) Cables
  2. MMPX(m)-to-MMPX(m) Cables
- 
3. Connect the PORT 4 connector of the PXIe-7902 front panel to the PORT 4 connector of the PXIe-7902 front panel using a Mini-SAS HD(m)-to-Mini-SAS HD(m) (8.25 in.) cable.

**Figure 9. Unidirectional SISO (Baseband and IF) RX Chassis**



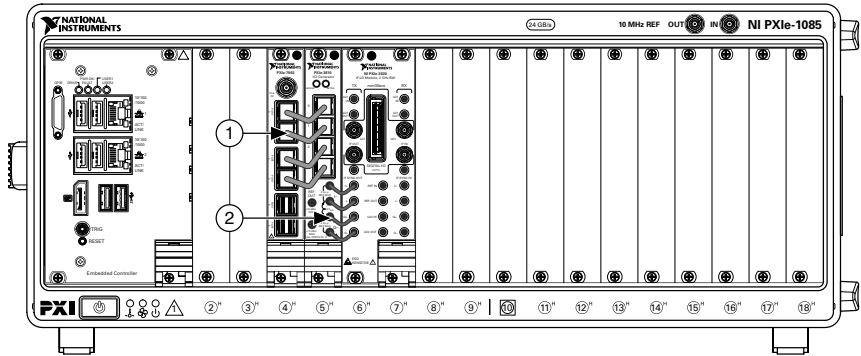
1. Mini-SAS HD(m)-to-Mini-SAS HD(m) (8.25 in.) Cables
  2. MMPX(m)-to-MMPX(m) Cables
  3. Mini-SAS HD(m)-to-Mini-SAS HD(m) (8.25 in.) Cable
4. Connect the adjoining PXIe-3610 and PXIe-3620 modules in the TX chassis using four MMPX(m)-to-MMPX(m) cables.
    - a) Connect the I+ connector of the PXIe-3610 front panel to the TX I+ connector of the PXIe-3620 front panel.
    - b) Connect the I- connector of the PXIe-3610 front panel to the TX I- connector of the PXIe-3620 front panel.
    - c) Connect the Q+ connector of the PXIe-3610 front panel to the TX Q+ connector of the PXIe-3620 front panel.
    - d) Connect the Q- connector of the PXIe-3610 front panel to the TX Q- connector of the PXIe-3620 front panel.
  5. Connect the adjoining PXIe-7902 and PXIe-3610 modules in the TX chassis using four Mini-SAS HD(m)-to-Mini-SAS HD(m) (8.25 in.) cables.
    - a) Connect the PORT 0 connector of the PXIe-7902 front panel to the 0 connector of the PXIe-3610 front panel.
    - b) Connect the PORT 1 connector of the PXIe-7902 front panel to the 1 connector of the PXIe-3610 front panel.
    - c) Connect the PORT 2 connector of the PXIe-7902 front panel to the 2 connector of the PXIe-3610 front panel.
    - d) Connect the PORT 3 connector of the PXIe-7902 front panel to the 3 connector of the PXIe-3610 front panel.

**Figure 10.** Interconnecting the PXle-7902, PXle-3610, and PXle-3620 Modules



1. Mini-SAS HD(m)-to-Mini-SAS HD(m) (8.25 in.) Cables
2. MMPX(m)-to-MMPX(m) Cables

**Figure 11. Unidirectional SISO (Baseband and IF) TX Chassis**



1. Mini-SAS HD(m)-to-Mini-SAS HD(m) (8.25 in.) Cables
2. MMPX(m)-to-MMPX(m) Cables

### Related Information

[Connecting mmRH-3642/3643/3652/3653 Radio Heads to a Unidirectional System](#) on page 39

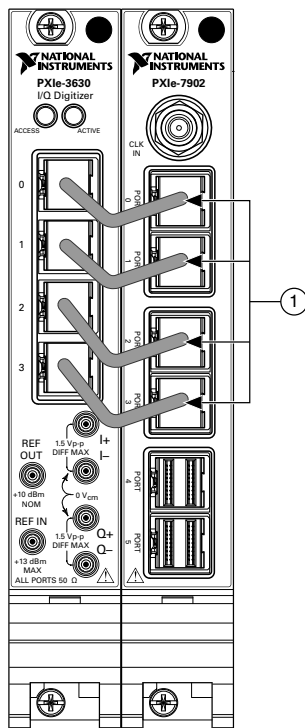
[Connecting mmRH-3647/3657 Radio Heads to a Unidirectional System](#) on page 42

## Interconnecting the Unidirectional MIMO (Baseband) Modules

Complete the following steps to connect the modules of the unidirectional MIMO (baseband) mmWave Transceiver System configuration.

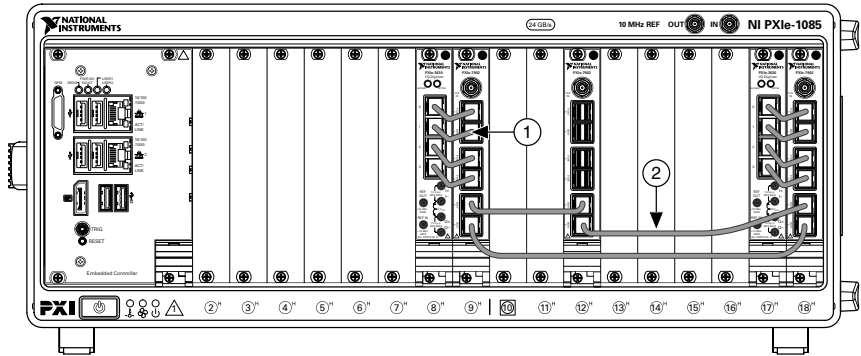
1. Connect the adjoining PXIe-3630 and PXIe-7902 modules in the RX chassis using four Mini-SAS HD(m)-to-Mini-SAS HD(m) (8.25 in.) cables.
  - a) Connect the 0 connector of the PXIe-3630 front panel to the PORT 0 connector of the PXIe-7902 front panel.
  - b) Connect the 1 connector of the PXIe-3630 front panel to the PORT 1 connector of the PXIe-7902 front panel.
  - c) Connect the 2 connector of the PXIe-3630 front panel to the PORT 2 connector of the PXIe-7902 front panel.
  - d) Connect the 3 connector of the PXIe-3630 front panel to the PORT 3 connector of the PXIe-7902 front panel.

**Figure 12.** Interconnecting the PXIe-3630 and PXIe-7902 Modules



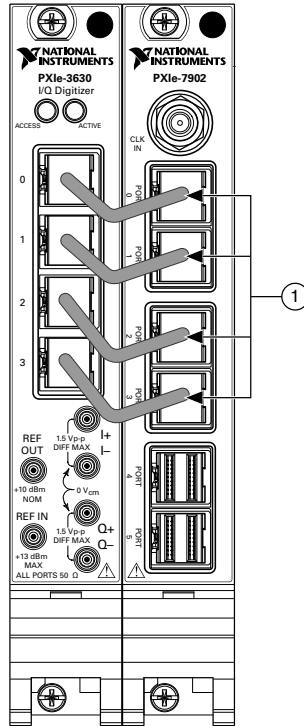
1. Mini-SAS HD(m)-to-Mini-SAS HD(m) (8.25 in.) Cables
2. Repeat step 1 to connect the second set of adjoining PXIe-3630 and PXIe-7902 modules in the RX chassis.
3. Connect the PXIe-7902 modules in the RX chassis using three Mini-SAS HD(m)-to-Mini-SAS HD(m) (8.25 in.) cables.
  - a) Connect the PORT 4 connector of the PXIe-7902 front panel in slot 9 of the chassis to the PORT 4 connector of the PXIe-7902 in slot 12 of the chassis.
  - b) Connect the PORT 5 connector of the PXIe-7902 front panel in slot 9 of the chassis to the PORT 5 connector of the PXIe-7902 in slot 18 of the chassis.
  - c) Connect the PORT 5 connector of the PXIe-7902 front panel in slot 12 of the chassis to the PORT 4 connector of the PXIe-7902 in slot 18 of the chassis.

**Figure 13.** Unidirectional MIMO (Baseband) RX Chassis



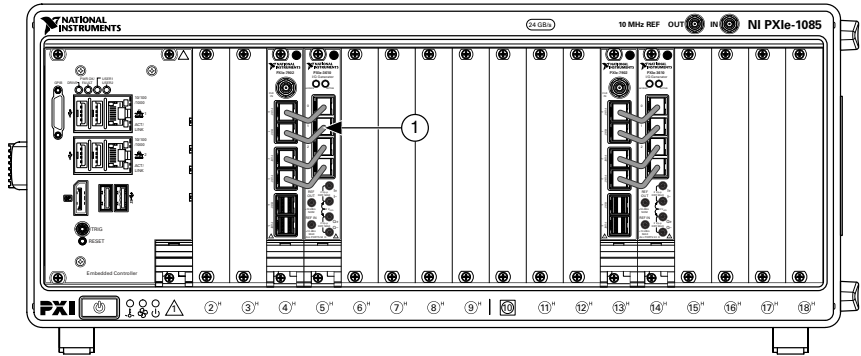
1. Mini-SAS HD(m)-to-Mini-SAS HD(m) (8.25 in.) Cables
  2. Mini-SAS HD(m)-to-Mini-SAS HD(m) (8.25 in.) Cables
- 
4. Connect the adjoining PXIe-7902 and PXIe-3610 modules in the TX chassis using four Mini-SAS HD(m)-to-Mini-SAS HD(m) (8.25 in.) cables.
    - a) Connect the PORT 0 connector of the PXIe-7902 front panel to the 0 connector of the PXIe-3610 front panel.
    - b) Connect the PORT 1 connector of the PXIe-7902 front panel to the 1 connector of the PXIe-3610 front panel.
    - c) Connect the PORT 2 connector of the PXIe-7902 front panel to the 2 connector of the PXIe-3610 front panel.
    - d) Connect the PORT 3 connector of the PXIe-7902 front panel to the 3 connector of the PXIe-3610 front panel.

**Figure 14.** Interconnecting the PXIe-3630 and PXIe-7902 Modules



1. Mini-SAS HD(m)-to-Mini-SAS HD(m) (8.25 in.) Cables
5. Repeat step 4 to connect the second set of adjoining PXIe-7902 and PXIe-3610 modules in the TX chassis.

**Figure 15. Unidirectional MIMO (Baseband) TX Chassis**



1. Mini-SAS HD(m)-to-Mini-SAS HD(m) (8.25 in.) Cables

Disconnect cables or otherwise attenuate the signal to ensure that no signal is entering the baseband ports on the PXIe-3630 module during system startup.

### Related Information

[Configuring the Coding Modules of a MIMO System](#) on page 50

## Interconnecting the Unidirectional MIMO (Baseband and IF) Modules

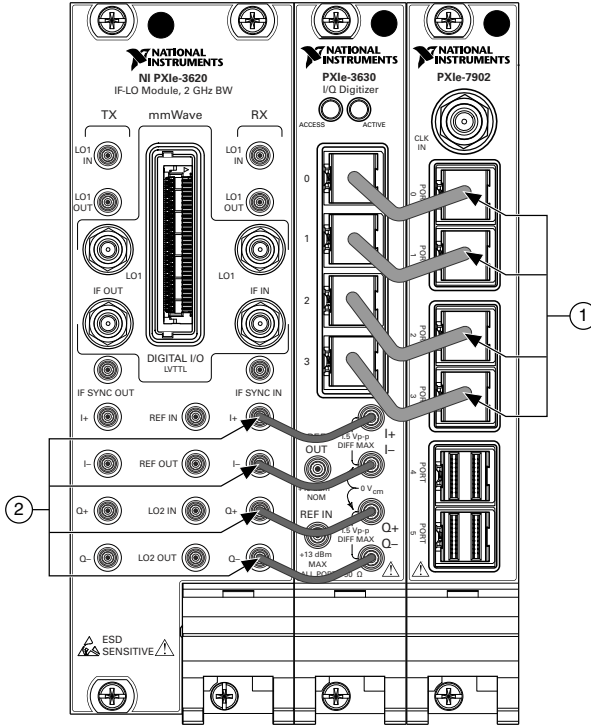
Complete the following steps to connect the modules of the unidirectional MIMO (baseband and IF) mmWave Transceiver System configuration.

1. Connect one set of adjoining PXIe-3620 and PXIe-3630 modules in the RX chassis using four MMPX(m)-to-MMPX(m) cables.
  - a) Connect the RX I+ connector of the PXIe-3620 front panel to the I+ connector of the PXIe-3630 front panel.
  - b) Connect the RX I- connector of the PXIe-3620 front panel to the I- connector of the PXIe-3630 front panel.
  - c) Connect the RX Q+ connector of the PXIe-3620 front panel to the Q+ connector of the PXIe-3630 front panel.
  - d) Connect the RX Q- connector of the PXIe-3620 front panel to the Q- connector of the PXIe-3630 front panel.
2. Connect the adjoining PXIe-3630 and PXIe-7902 modules in the RX chassis using four Mini-SAS HD(m)-to-Mini-SAS HD(m) (8.25 in.) cables.
  - a) Connect the 0 connector of the PXIe-3630 front panel to the PORT 0 connector of the PXIe-7902 front panel.
  - b) Connect the 1 connector of the PXIe-3630 front panel to the PORT 1 connector of the PXIe-7902 front panel.
  - c) Connect the 2 connector of the PXIe-3630 front panel to the PORT 2 connector of the PXIe-7902 front panel.



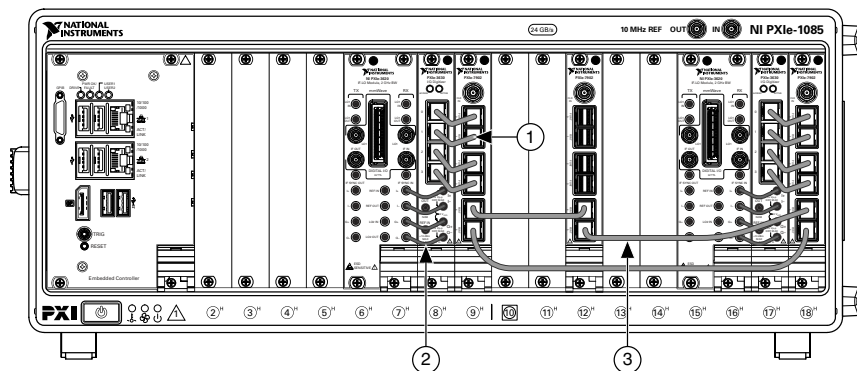
- d) Connect the 3 connector of the PXIe-3630 front panel to the PORT 3 connector of the PXIe-7902 front panel.

**Figure 16.** Interconnecting the PXIe-3620, PXIe-3630, and PXIe-7902 Modules



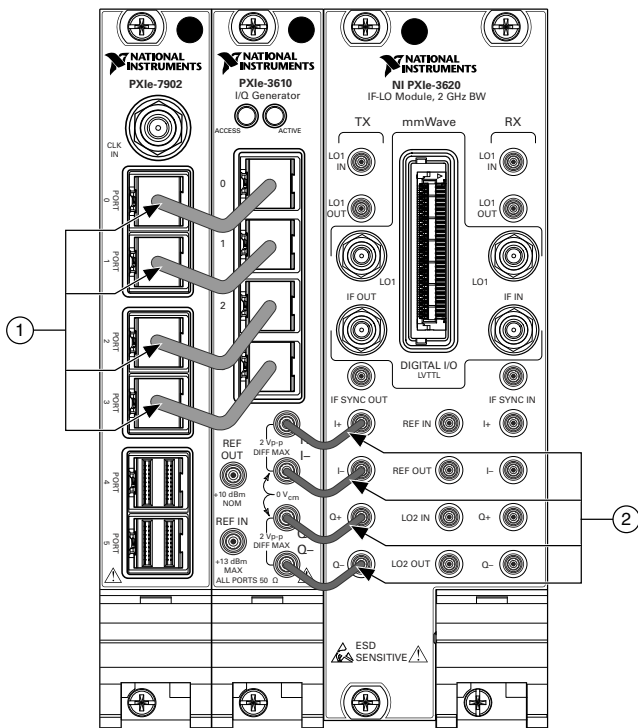
1. Mini-SAS HD(m)-to-Mini-SAS HD(m) (8.25 in.) Cables
  2. MMPX(m)-to-MMPX(m) Cables
3. Repeat steps 1 and 2 to connect the second set of adjoining PXIe-3620, PXIe-3630, and PXIe-7902 modules in the RX chassis.
  4. Connect the PXIe-7902 modules in the RX chassis using three Mini-SAS HD(m)-to-Mini-SAS HD(m) (8.25 in.) cables.
    - a) Connect the PORT 4 connector of the PXIe-7902 front panel in slot 9 of the chassis to the PORT 4 connector of the PXIe-7902 in slot 12 of the chassis.
    - b) Connect the PORT 5 connector of the PXIe-7902 front panel in slot 9 of the chassis to the PORT 5 connector of the PXIe-7902 in slot 18 of the chassis.
    - c) Connect the PORT 5 connector of the PXIe-7902 front panel in slot 12 of the chassis to the PORT 4 connector of the PXIe-7902 in slot 18 of the chassis.

**Figure 17.** Unidirectional MIMO (Baseband and IF) RX Chassis



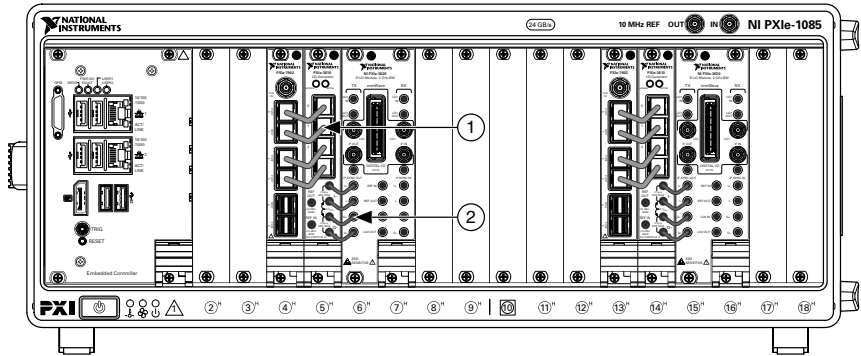
1. Mini-SAS HD(m)-to-Mini-SAS HD(m) (8.25 in.) Cables
  2. MMPX(m)-to-MMPX(m) Cables
  3. Mini-SAS HD(m)-to-Mini-SAS HD(m) (8.25 in.) Cables
- 
5. Connect the adjoining PXIe-3610 and PXIe-3620 modules in the TX chassis using four MMPX(m)-to-MMPX(m) cables.
    - a) Connect the I+ connector of the PXIe-3610 front panel to the TX I+ connector of the PXIe-3620 front panel.
    - b) Connect the I- connector of the PXIe-3610 front panel to the TX I- connector of the PXIe-3620 front panel.
    - c) Connect the Q+ connector of the PXIe-3610 front panel to the TX Q+ connector of the PXIe-3620 front panel.
    - d) Connect the Q- connector of the PXIe-3610 front panel to the TX Q- connector of the PXIe-3620 front panel.
  6. Connect the adjoining PXIe-7902 and PXIe-3610 modules in the TX chassis using four Mini-SAS HD(m)-to-Mini-SAS HD(m) (8.25 in.) cables.
    - a) Connect the PORT 0 connector of the PXIe-7902 front panel to the 0 connector of the PXIe-3610 front panel.
    - b) Connect the PORT 1 connector of the PXIe-7902 front panel to the 1 connector of the PXIe-3610 front panel.
    - c) Connect the PORT 2 connector of the PXIe-7902 front panel to the 2 connector of the PXIe-3610 front panel.
    - d) Connect the PORT 3 connector of the PXIe-7902 front panel to the 3 connector of the PXIe-3610 front panel.

**Figure 18.** Interconnecting the PXIe-7902, PXIe-3610, and PXIe-3620 Modules



1. Mini-SAS HD(m)-to-Mini-SAS HD(m) (8.25 in.) Cables
  2. MMPX(m)-to-MMPX(m) Cables
7. Repeat steps 5 and 6 to connect the second set of adjoining PXIe-7902, PXIe-3610, PXIe-3620, and modules in the TX chassis.

**Figure 19.** Unidirectional MIMO (Baseband and IF) TX Chassis



1. Mini-SAS HD(m)-to-Mini-SAS HD(m) (8.25 in.) Cables
2. MMPX(m)-to-MMPX(m) Cables

8. Repeat steps 1 through 6 for the second set of chassis.

### Related Information

[Connecting mmRH-3642/3643/3652/3653 Radio Heads to a Unidirectional System](#) on page 39

[Connecting mmRH-3647/3657 Radio Heads to a Unidirectional System](#) on page 42

[Configuring the Coding Modules of a MIMO System](#) on page 50

## Bidirectional System Setup

This section describes how to connect the modules of a bidirectional mmWave Transceiver System.

Bidirectional mmWave Transceiver System configurations are as follows:

- Bidirectional SISO (baseband)
- Bidirectional SISO (baseband and IF)
- Bidirectional MIMO (baseband)
- Bidirectional MIMO (baseband and IF)

Each configuration consists of two RX/TX chassis with identical module configurations.

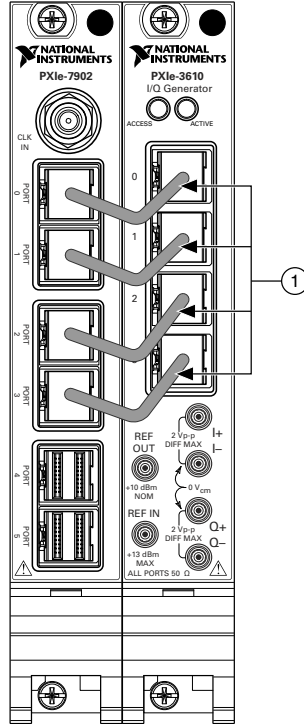
### Interconnecting the Bidirectional SISO (Baseband) Modules

Complete the following steps to connect the modules of the bidirectional SISO (baseband) mmWave Transceiver System configuration.

1. Connect the adjoining PXIe-7902 and PXIe-3610 modules using four Mini-SAS HD(m)-to-Mini-SAS HD(m) (8.25 in.) cables.
  - a) Connect the PORT 0 connector of the PXIe-7902 front panel to the 0 connector of the PXIe-3610 front panel.

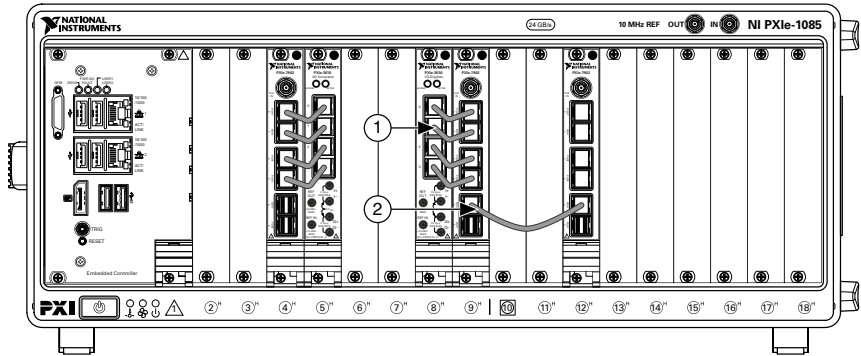
- b) Connect the PORT 1 connector of the PXIe-7902 front panel to the 1 connector of the PXIe-3610 front panel.
- c) Connect the PORT 2 connector of the PXIe-7902 front panel to the 2 connector of the PXIe-3610 front panel.
- d) Connect the PORT 3 connector of the PXIe-7902 front panel to the 3 connector of the PXIe-3610 front panel.

**Figure 20.** Interconnecting the PXIe-7902 and PXIe-3610 Modules



1. Mini-SAS HD(m)-to-Mini-SAS HD(m) (8.25 in.) Cables
2. Connect the adjoining PXIe-3630 and PXIe-7902 modules using four Mini-SAS HD(m)-to-Mini-SAS HD(m) (8.25 in.) cables.
  - a) Connect the 0 connector of the PXIe-3630 front panel to the PORT 0 connector of the PXIe-7902 front panel.
  - b) Connect the 1 connector of the PXIe-3630 front panel to the PORT 1 connector of the PXIe-7902 front panel.
  - c) Connect the 2 connector of the PXIe-3630 front panel to the PORT 2 connector of the PXIe-7902 front panel.
  - d) Connect the 3 connector of the PXIe-3630 front panel to the PORT 3 connector of the PXIe-7902 front panel.
3. Connect the PORT 4 connector of the PXIe-7902 front panel to the PORT 4 connector of the second PXIe-7902 front panel.

**Figure 21.** Bidirectional SISO (Baseband) Chassis



1. Mini-SAS HD(m)-to-Mini-SAS HD(m) (8.25 in.) Cables
2. Mini-SAS HD(m)-to-Mini-SAS HD(m) (8.25 in.) Cable

4. Repeat steps 1 through 3 for the second RX/TX chassis.

Disconnect cables or otherwise attenuate the signal to ensure that no signal is entering the baseband ports on the PXIe-3630 module during system startup.

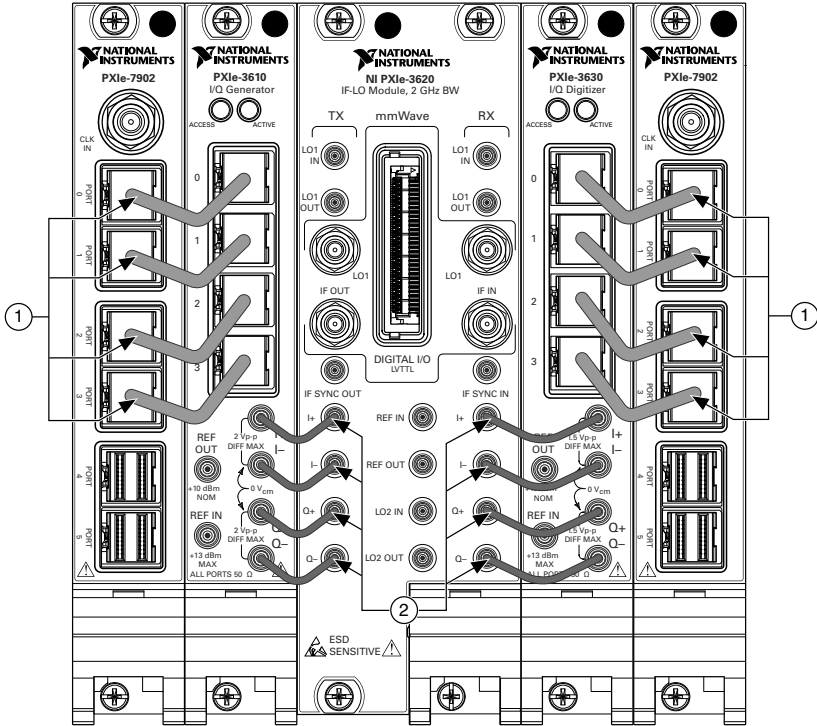
## Interconnecting the Bidirectional SISO (Baseband and IF) Modules

Complete the following steps to connect the modules of the bidirectional SISO (baseband and IF) mmWave Transceiver System configuration.

1. Connect the adjoining PXIe-3610 and PXIe-3620 modules using four MMPX(m)-to-MMPX(m) cables.
  - a) Connect the I+ connector of the PXIe-3610 front panel to the TX I+ connector of the PXIe-3620 front panel.
  - b) Connect the I- connector of the PXIe-3610 front panel to the TX I- connector of the PXIe-3620 front panel.
  - c) Connect the Q+ connector of the PXIe-3610 front panel to the TX Q+ connector of the PXIe-3620 front panel.
  - d) Connect the Q- connector of the PXIe-3610 front panel to the TX Q- connector of the PXIe-3620 front panel.
2. Connect the adjoining PXIe-3620 and PXIe-3630 modules using four MMPX(m)-to-MMPX(m) cables.
  - a) Connect the RX I+ connector of the PXIe-3620 front panel to the I+ connector of the PXIe-3630 front panel.
  - b) Connect the RX I- connector of the PXIe-3620 front panel to the I- connector of the PXIe-3630 front panel.
  - c) Connect the RX Q+ connector of the PXIe-3620 front panel to the Q+ connector of the PXIe-3630 front panel.
  - d) Connect the RX Q- connector of the PXIe-3620 front panel to the Q- connector of the PXIe-3630 front panel.

3. Connect the adjoining PXIe-7902 and PXIe-3610 modules using four Mini-SAS HD(m)-to-Mini-SAS HD(m) (8.25 in.) cables.
  - a) Connect the PORT 0 connector of the PXIe-7902 front panel to the 0 connector of the PXIe-3610 front panel.
  - b) Connect the PORT 1 connector of the PXIe-7902 front panel to the 1 connector of the PXIe-3610 front panel.
  - c) Connect the PORT 2 connector of the PXIe-7902 front panel to the 2 connector of the PXIe-3610 front panel.
  - d) Connect the PORT 3 connector of the PXIe-7902 front panel to the 3 connector of the PXIe-3610 front panel.
4. Connect the adjoining PXIe-3630 and PXIe-7902 modules using four Mini-SAS HD(m)-to-Mini-SAS HD(m) (8.25 in.) cables.
  - a) Connect the 0 connector of the PXIe-3630 front panel to the PORT 0 connector of the PXIe-7902 front panel.
  - b) Connect the 1 connector of the PXIe-3630 front panel to the PORT 1 connector of the PXIe-7902 front panel.
  - c) Connect the 2 connector of the PXIe-3630 front panel to the PORT 2 connector of the PXIe-7902 front panel.
  - d) Connect the 3 connector of the PXIe-3630 front panel to the PORT 3 connector of the PXIe-7902 front panel.

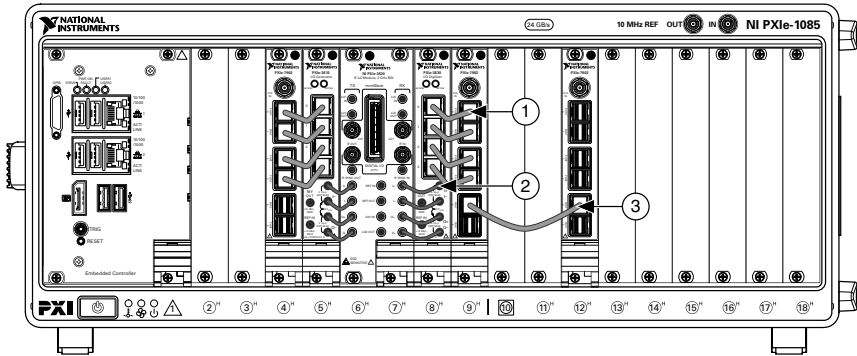
**Figure 22.** Interconnecting the PXIe-7902, PXIe-3610, PXIe-3620, PXIe-3630, and PXIe-7902 Modules



1. Mini-SAS HD(m)-to-Mini-SAS HD(m) (8.25 in.) Cables
  2. MMPX(m)-to-MMPX(m) Cables
5. Connect the PORT 4 connector of the PXIe-7902 front panel in the center of the chassis to the PORT 4 connector of the PXIe-7902 front panel on the right side of the chassis.



**Figure 23.** Bidirectional SISO (Baseband and IF) Chassis



1. Mini-SAS HD(m)-to-Mini-SAS HD(m) (8.25 in.) Cables
  2. MMPX(m)-to-MMPX(m) Cables
  3. Mini-SAS HD(m)-to-Mini-SAS HD(m) (8.25 in.) Cable
6. Repeat steps 1 through 5 for the second RX/TX chassis.

### Related Information

[Connecting mmRH-3602/3603 Radio Heads to a Bidirectional System](#) on page 44

[Connecting mmRH-3642/3643/3652/3653 Radio Heads to a Bidirectional System](#) on page 47

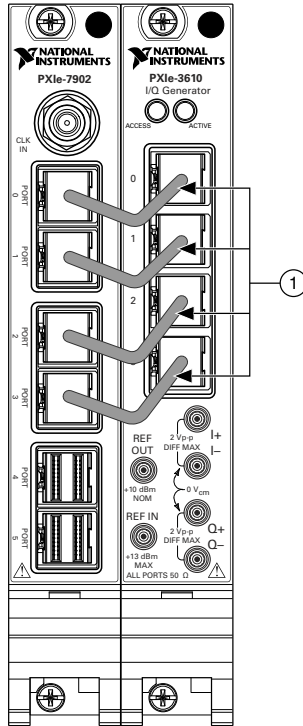
[Connecting mmRH-3647/3657 Radio Heads to a Bidirectional System](#) on page 49

## Interconnecting the Bidirectional MIMO (Baseband) Modules

Complete the following steps to connect the modules of the bidirectional MIMO (baseband) mmWave Transceiver System configuration.

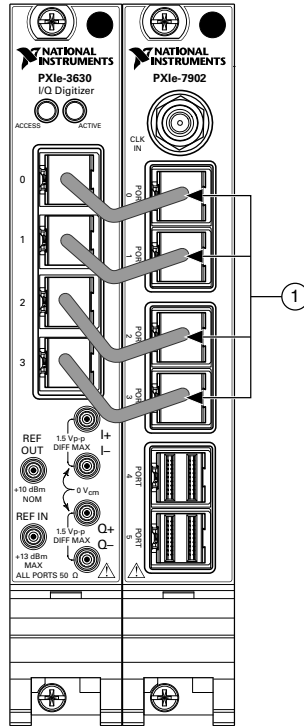
1. Connect the adjoining PXIe-7902 and PXIe-3610 modules using four Mini-SAS HD(m)-to-Mini-SAS HD(m) (8.25 in.) cables.
  - a) Connect the PORT 0 connector of the PXIe-7902 front panel to the 0 connector of the PXIe-3610 front panel.
  - b) Connect the PORT 1 connector of the PXIe-7902 front panel to the 1 connector of the PXIe-3610 front panel.
  - c) Connect the PORT 2 connector of the PXIe-7902 front panel to the 2 connector of the PXIe-3610 front panel.
  - d) Connect the PORT 3 connector of the PXIe-7902 front panel to the 3 connector of the PXIe-3610 front panel.

**Figure 24.** Interconnecting the PXIe-7902 and PXIe-3610 Modules



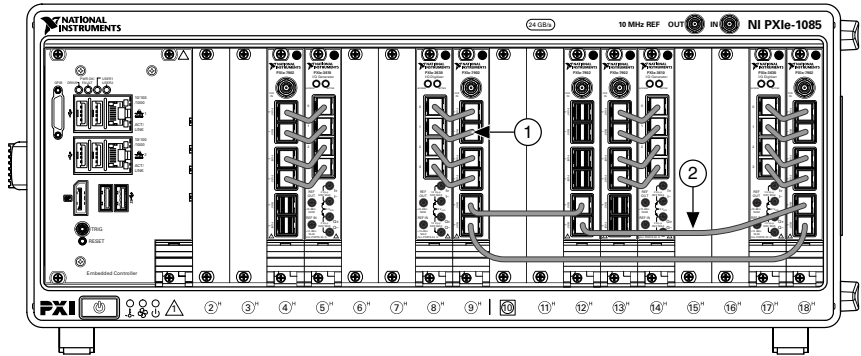
1. Mini-SAS HD(m)-to-Mini-SAS HD(m) (8.25 in.) Cables
2. Repeat step 1 to connect the second set of adjoining PXIe-7902 and PXIe-3610 modules.
3. Connect the adjoining PXIe-3630 and PXIe-7902 modules using four Mini-SAS HD(m)-to-Mini-SAS HD(m) (8.25 in.) cables.
  - a) Connect the 0 connector of the PXIe-3630 front panel to the PORT 0 connector of the PXIe-7902 front panel.
  - b) Connect the 1 connector of the PXIe-3630 front panel to the PORT 1 connector of the PXIe-7902 front panel.
  - c) Connect the 2 connector of the PXIe-3630 front panel to the PORT 2 connector of the PXIe-7902 front panel.
  - d) Connect the 3 connector of the PXIe-3630 front panel to the PORT 3 connector of the PXIe-7902 front panel.

**Figure 25.** Interconnecting the PXIe-3630 and PXIe-7902 Modules



1. Mini-SAS HD(m)-to-Mini-SAS HD(m) (8.25 in.) Cables
4. Repeat step 3 to connect the second set of adjoining PXIe-3630 and PXIe-7902 modules.
5. Connect the PXIe-7902 modules in the chassis using three Mini-SAS HD(m)-to-Mini-SAS HD(m) (8.25 in.) cables.
  - a) Connect the PORT 4 connector of the PXIe-7902 front panel in slot 9 of the chassis to the PORT 4 connector of the PXIe-7902 in slot 12 of the chassis.
  - b) Connect the PORT 5 connector of the PXIe-7902 front panel in slot 9 of the chassis to the PORT 5 connector of the PXIe-7902 in slot 18 of the chassis.
  - c) Connect the PORT 5 connector of the PXIe-7902 front panel in slot 12 of the chassis to the PORT 4 connector of the PXIe-7902 in slot 18 of the chassis.

**Figure 26. Bidirectional MIMO (Baseband) Chassis**



1. Mini-SAS HD(m)-to-Mini-SAS HD(m) (8.25 in.) Cables
2. Mini-SAS HD(m)-to-Mini-SAS HD(m) (8.25 in.) Cables

6. Repeat steps 1 through 5 for the second RX/TX chassis.

Disconnect cables or otherwise attenuate the signal to ensure that no signal is entering the baseband ports on the PXIe-3630 module during system startup.

### Related Information

[Configuring the Coding Modules of a MIMO System](#) on page 50

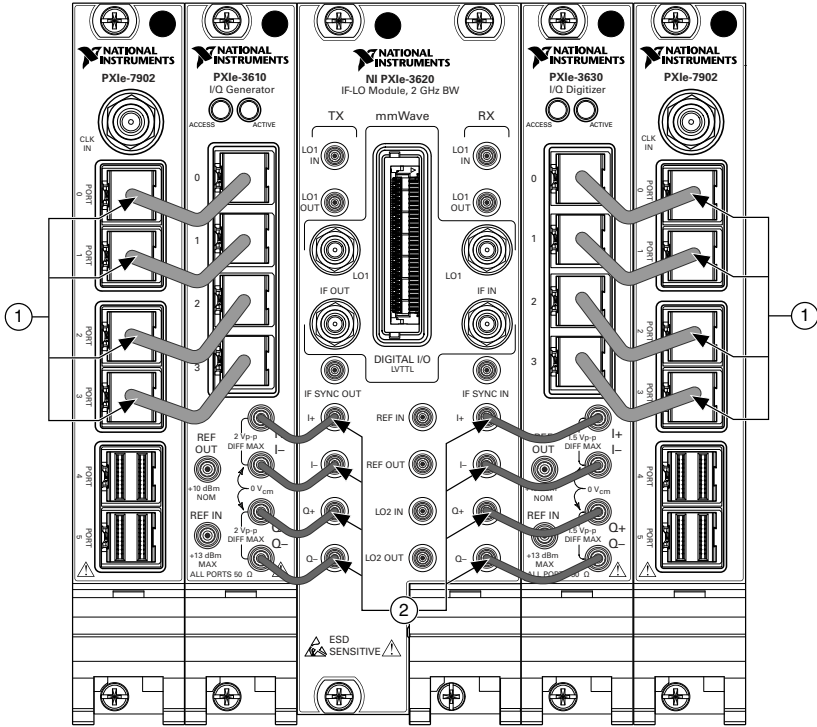
## Interconnecting the Bidirectional MIMO (Baseband and IF) Modules

Complete the following steps to connect the modules of the bidirectional MIMO (baseband and IF) mmWave Transceiver System configuration.

1. Connect the adjoining PXIe-3610 and PXIe-3620 modules using four MMPX(m)-to-MMPX(m) cables.
  - a) Connect the I+ connector of the PXIe-3610 front panel to the TX I+ connector of the PXIe-3620 front panel.
  - b) Connect the I- connector of the PXIe-3610 front panel to the TX I- connector of the PXIe-3620 front panel.
  - c) Connect the Q+ connector of the PXIe-3610 front panel to the TX Q+ connector of the PXIe-3620 front panel.
  - d) Connect the Q- connector of the PXIe-3610 front panel to the TX Q- connector of the PXIe-3620 front panel.
2. Connect the adjoining PXIe-3620 and PXIe-3630 modules using four MMPX(m)-to-MMPX(m) cables.
  - a) Connect the RX I+ connector of the PXIe-3620 front panel to the I+ connector of the PXIe-3630 front panel.
  - b) Connect the RX I- connector of the PXIe-3620 front panel to the I- connector of the PXIe-3630 front panel.

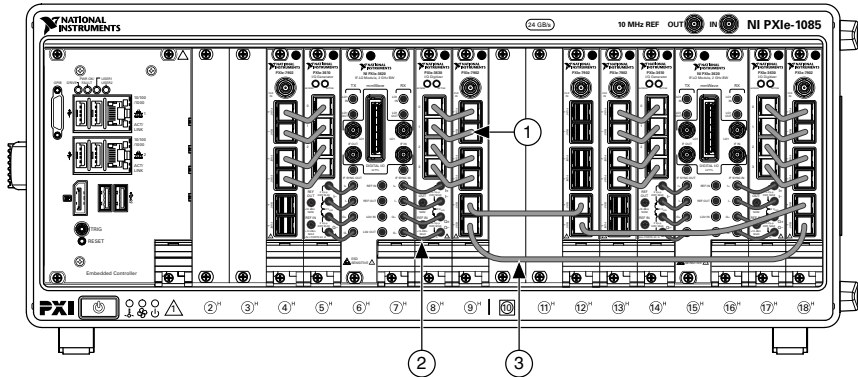
- c) Connect the RX Q+ connector of the PXIe-3620 front panel to the Q+ connector of the PXIe-3630 front panel.
  - d) Connect the RX Q- connector of the PXIe-3620 front panel to the Q- connector of the PXIe-3630 front panel.
3. Connect the adjoining PXIe-7902 and PXIe-3610 modules using four Mini-SAS HD(m)-to-Mini-SAS HD(m) (8.25 in.) cables.
- a) Connect the PORT 0 connector of the PXIe-7902 front panel to the 0 connector of the PXIe-3610 front panel.
  - b) Connect the PORT 1 connector of the PXIe-7902 front panel to the 1 connector of the PXIe-3610 front panel.
  - c) Connect the PORT 2 connector of the PXIe-7902 front panel to the 2 connector of the PXIe-3610 front panel.
  - d) Connect the PORT 3 connector of the PXIe-7902 front panel to the 3 connector of the PXIe-3610 front panel.
4. Connect the adjoining PXIe-3630 and PXIe-7902 modules using four Mini-SAS HD(m)-to-Mini-SAS HD(m) (8.25 in.) cables.
- a) Connect the 0 connector of the PXIe-3630 front panel to the PORT 0 connector of the PXIe-7902 front panel.
  - b) Connect the 1 connector of the PXIe-3630 front panel to the PORT 1 connector of the PXIe-7902 front panel.
  - c) Connect the 2 connector of the PXIe-3630 front panel to the PORT 2 connector of the PXIe-7902 front panel.
  - d) Connect the 3 connector of the PXIe-3630 front panel to the PORT 3 connector of the PXIe-7902 front panel.

**Figure 27.** Interconnecting the PXIe-7902, PXIe-3610, PXIe-3620, PXIe-3630, and PXIe-7902 Modules



1. Mini-SAS HD(m)-to-Mini-SAS HD(m) (8.25 in.) Cables
  2. MMPX(m)-to-MMPX(m) Cables
5. Repeat steps 1 through 4 to connect the second set of adjoining PXIe-7902, PXIe-3610, PXIe-3620, PXIe-3630, and PXIe-7902 modules.
  6. Connect the PXIe-7902 modules in the chassis using three Mini-SAS HD(m)-to-Mini-SAS HD(m) (8.25 in.) cables.
    - a) Connect the PORT 4 connector of the PXIe-7902 front panel in slot 9 of the chassis to the PORT 4 connector of the PXIe-7902 in slot 12 of the chassis.
    - b) Connect the PORT 5 connector of the PXIe-7902 front panel in slot 9 of the chassis to the PORT 5 connector of the PXIe-7902 in slot 18 of the chassis.
    - c) Connect the PORT 5 connector of the PXIe-7902 front panel in slot 12 of the chassis to the PORT 4 connector of the PXIe-7902 in slot 18 of the chassis.

**Figure 28.** Bidirectional MIMO (Baseband and IF) Chassis



1. Mini-SAS HD(m)-to-Mini-SAS HD(m) (8.25 in.) Cables
2. MMPX(m)-to-MMPX(m) Cables
3. Mini-SAS HD(m)-to-Mini-SAS HD(m) (8.25 in.) Cables

7. Repeat steps 1 through 6 for the second RX/TX chassis.

### Related Information

[Connecting mmRH-3602/3603 Radio Heads to a Bidirectional System](#) on page 44

[Connecting mmRH-3642/3643/3652/3653 Radio Heads to a Bidirectional System](#) on page 47

[Connecting mmRH-3647/3657 Radio Heads to a Bidirectional System](#) on page 49

[Configuring the Coding Modules of a MIMO System](#) on page 50

## Connecting mmWave Radio Heads to the System

### Recommended Torque

Ensure that connectors are torqued to the appropriate level when connecting mmWave radio heads to the system.

**Table 6.** Recommended Connector Torque

| Connector Type | Recommended Torque |
|----------------|--------------------|
| 2.4 mm         | 0.9 N·m (8 in·lb)  |
| 2.92 mm        | 0.9 N·m (8 in·lb)  |
| 3.5 mm (SMA)   | 0.9 N·m (8 in·lb)  |

**Related Information**

[mmRH-3602 Front/Back Panel and LEDs](#) on page 68

[mmRH-3603 Front/Back Panel and LEDs](#) on page 71

[mmRH-3642 Front/Back Panel and LEDs](#) on page 74

[mmRH-3643 Front/Back Panel and LEDs](#) on page 76

[mmRH-3647 Front/Back Panel and LEDs](#) on page 78

[mmRH-3652 Front/Back Panel and LEDs](#) on page 80

[mmRH-3653 Front/Back Panel and LEDs](#) on page 82

[mmRH-3657 Front/Back Panel and LEDs](#) on page 84

## Connecting mmWave Radio Heads to a Unidirectional System

### Connecting mmRH-3642/3643/3652/3653 Radio Heads to a Unidirectional System

Complete the following steps to connect mmRH-3642/3643/3652/3653 radio heads to a unidirectional mmWave Transceiver System.



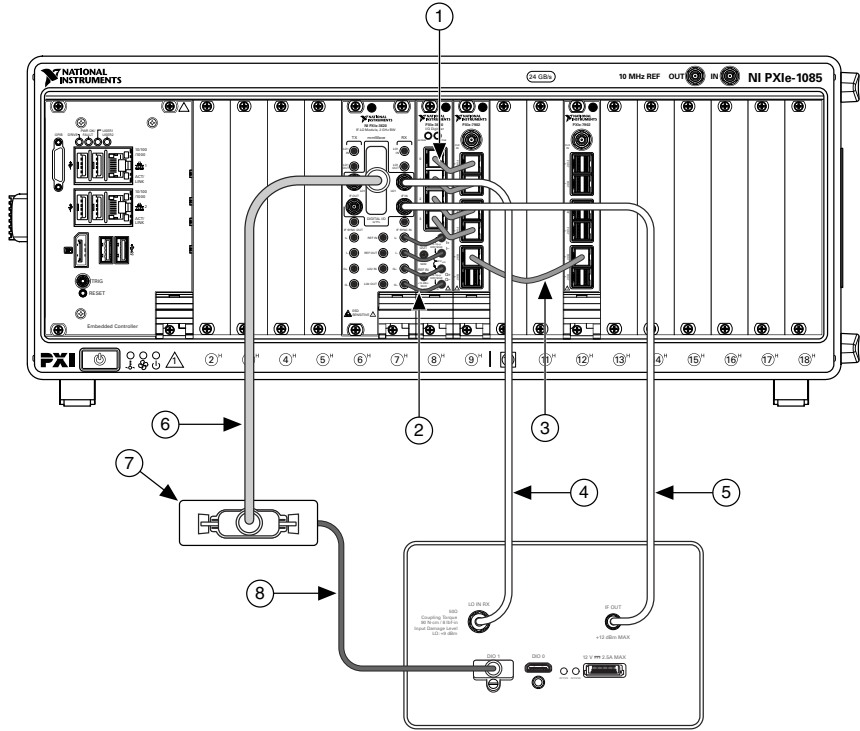
**Note** Connect the modules of the mmWave Transceiver System for standard use before connecting mmRH-3642/3643/3652/3653 radio heads.

1. Connect the RX chassis to the mmRH-3652/3653.
  - a) Connect the DIGITAL I/O connector of the PXIe-3620 front panel in the RX chassis to the DIO adapter module using an EPLSP cable.
  - b) Connect the DIO adapter module to the DIO 1 connector<sup>1</sup> of the mmRH-3652/3653 back panel using an HDMI(m)-to-mini-HDMI(m) cable.
  - c) Connect the RX LO1 connector of the PXIe-3620 front panel in the RX chassis to the LO IN RX connector of the mmRH-3652/3653 back panel using an SMA(m)-to-SMA(m) cable.
  - d) Connect the RX IF IN connector of the PXIe-3620 front panel in the RX chassis to the IF OUT connector of the mmRH-3652/3653 back panel using an SMA(m)-to-SMA(m) cable.

<sup>1</sup> You may connect the DIO adapter module to the DIO 0 connector instead of the DIO 1 connector. The choice of connector does not affect results.



**Figure 29.** Connecting the mmRH-3652/3653 to the Unidirectional SISO (Baseband and IF) RX Chassis



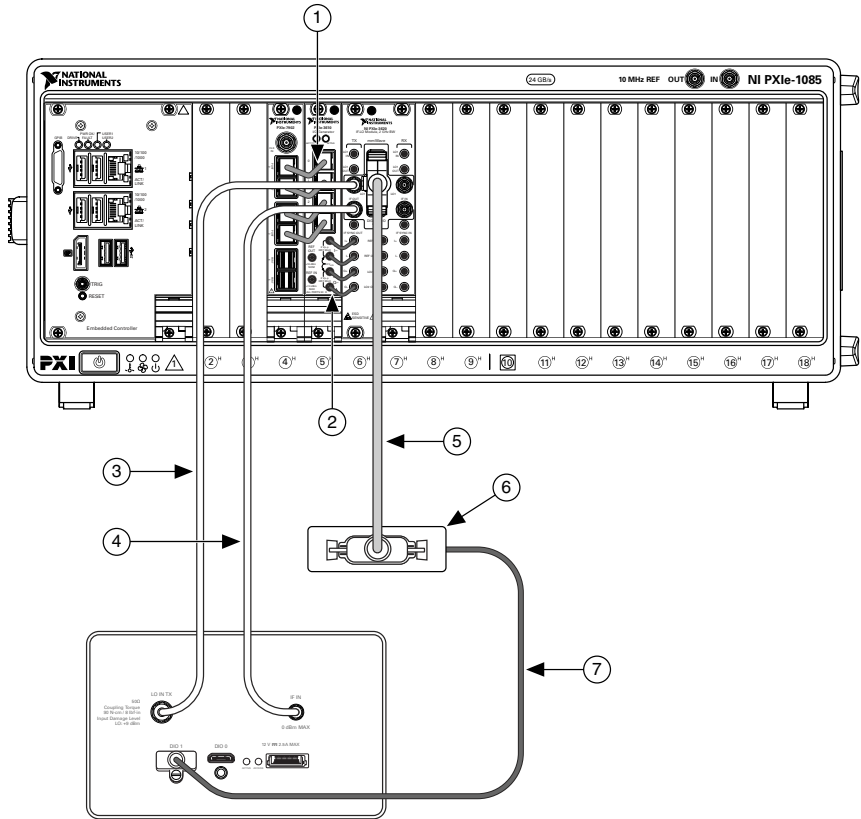
- |                                                       |                                  |
|-------------------------------------------------------|----------------------------------|
| 1. Mini-SAS HD(m)-to-Mini-SAS HD(m) (8.25 in.) Cables | 5. SMA(m)-to-SMA(m) Cable        |
| 2. MMPX(m)-to-MMPX(m) Cables                          | 6. EPLSP Cable                   |
| 3. Mini-SAS HD(m)-to-Mini-SAS HD(m) (8.25 in.) Cable  | 7. DIO Adapter Module            |
| 4. SMA(m)-to-SMA(m) Cable                             | 8. HDMI(m)-to-mini-HDMI(m) Cable |

- e) If you have a MIMO system, repeat steps a through d for the second PXIe-3620 module in the RX chassis and a second mmRH-3652/3653.
2. Connect the TX chassis to the mmRH-3642/3643.
  - a) Connect the DIGITAL I/O connector of the PXIe-3620 front panel in the TX chassis to the DIO adapter module using an EPLSP cable.
  - b) Connect the DIO adapter module to the DIO 1 connector<sup>2</sup> of the mmRH-3642/3643 back panel using an HDMI(m)-to-mini-HDMI(m) cable.
  - c) Connect the TX LO1 connector of the PXIe-3620 front panel in the TX chassis to the LO IN TX connector of the mmRH-3642/3643 back panel using an SMA(m)-to-SMA(m) cable.

<sup>2</sup> You may connect the DIO adapter module to the DIO 0 connector instead of the DIO 1 connector. The choice of connector does not affect results.

- d) Connect the TX IF OUT connector of the PXIe-3620 front panel in the TX chassis to the IF IN connector of the mmRH-3642/3643 back panel using an SMA(m)-to-SMA(m) cable.

**Figure 30.** Connecting the mmRH-3642/3643 to the Unidirectional SISO (Baseband and IF) TX Chassis



- |                                                       |                                  |
|-------------------------------------------------------|----------------------------------|
| 1. Mini-SAS HD(m)-to-Mini-SAS HD(m) (8.25 in.) Cables | 5. EPLSP Cable                   |
| 2. MMPX(m)-to-MMPX(m) Cables                          | 6. DIO Adapter Module            |
| 3. SMA(m)-to-SMA(m) Cable                             | 7. HDMI(m)-to-mini-HDMI(m) Cable |
| 4. SMA(m)-to-SMA(m) Cable                             |                                  |

- e) If you have a MIMO system, repeat steps a through d for the second PXIe-3620 module in the TX chassis and a second mmRH-3642/3643.

3. Connect all mmWave radio heads to power.

## Related Information

[Interconnecting the Unidirectional MIMO \(Baseband and IF\) Modules](#) on page 23

[Interconnecting the Unidirectional SISO \(Baseband and IF\) Modules](#) on page 15

## Connecting mmRH-3647/3657 Radio Heads to a Unidirectional System

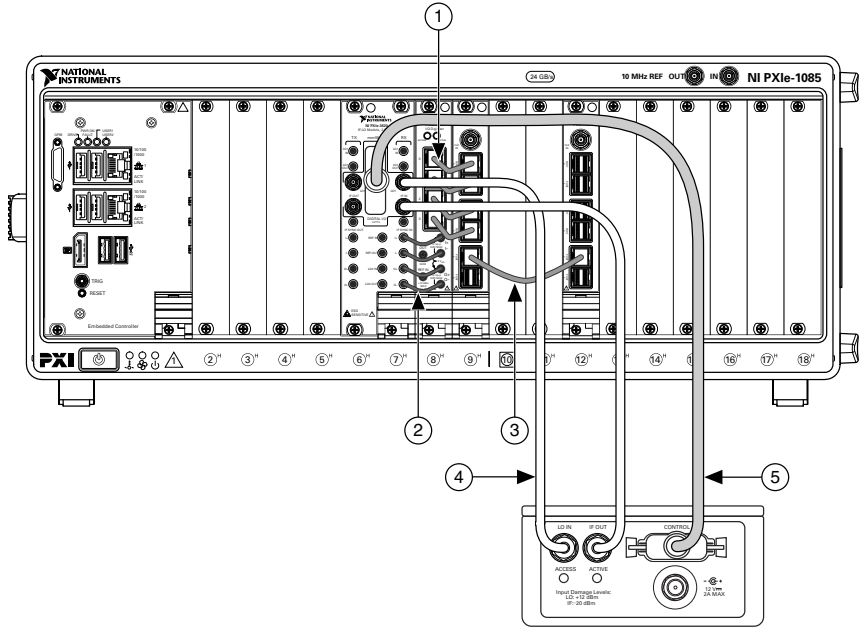
Complete the following steps to connect mmRH-3647/3657 radio heads to a unidirectional mmWave Transceiver System.



**Note** Connect the modules of the mmWave Transceiver System for standard use before connecting mmRH-3647/3657 radio heads.

1. Connect the RX chassis to the mmRH-3657.
  - a) Connect the DIGITAL I/O connector of the PXIe-3620 front panel in the RX chassis to the CONTROL connector of the mmRH-3657 back panel using an EPLSP cable.
  - b) Connect the RX LO1 connector of the PXIe-3620 front panel in the RX chassis to the LO IN connector of the mmRH-3657 back panel using an SMA(m)-to-SMA(m) cable.
  - c) Connect the RX IF IN connector of the PXIe-3620 front panel in the RX chassis to the IF OUT connector of the mmRH-3657 back panel using an SMA(m)-to-SMA(m) cable.

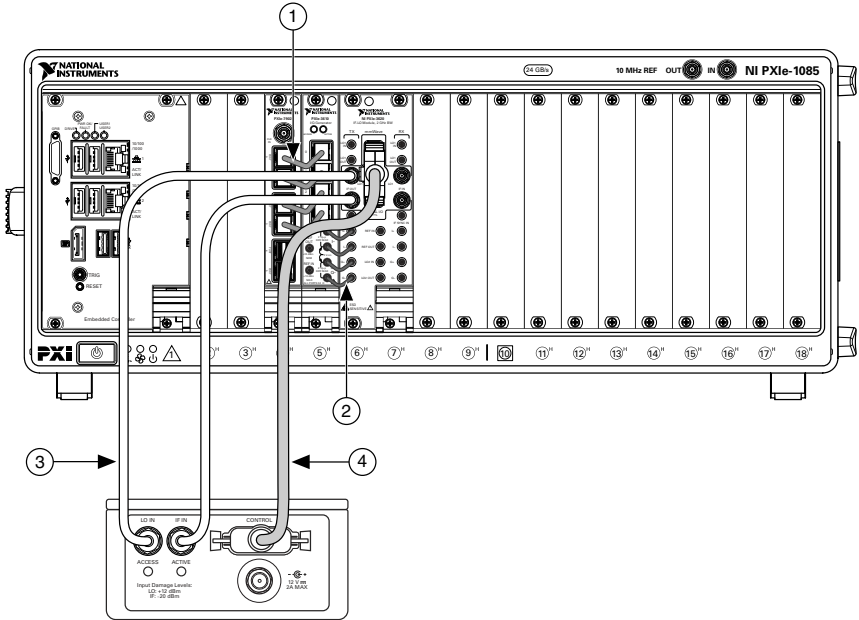
**Figure 31.** Connecting the mmRH-3657 to the Unidirectional SISO (Baseband and IF) RX Chassis



1. Mini-SAS HD(m)-to-Mini-SAS HD(m) (8.25 in.) Cables
2. MMPX(m)-to-MMPX(m) Cables
3. Mini-SAS HD(m)-to-Mini-SAS HD(m) (8.25 in.) Cable
4. SMA(m)-to-SMA(m) Cables
5. EPLSP Cable

- d) If you have a MIMO system, repeat steps a through c for the second PXIe-3620 module in the RX chassis and a second mmRH-3657.
2. Connect the TX chassis to the mmRH-3647.
    - a) Connect the DIGITAL I/O connector of the PXIe-3620 front panel in the TX chassis to the CONTROL connector of the mmRH-3647 back panel using an EPLSP cable.
    - b) Connect the TX LO1 connector of the PXIe-3620 front panel in the TX chassis to the LO IN connector of the mmRH-3647 back panel using an SMA(m)-to-SMA(m) cable.
    - c) Connect the TX IF OUT connector of the PXIe-3620 front panel in the TX chassis to the IF IN connector of the mmRH-3647 back panel using an SMA(m)-to-SMA(m) cable.

**Figure 32.** Connecting the mmRH-3647 to the Unidirectional SISO (Baseband and IF) TX Chassis



- 1. Mini-SAS HD(m)-to-Mini-SAS HD(m) (8.25 in.) Cables
- 2. MMPX(m)-to-MMPX(m) Cables
- 3. SMA(m)-to-SMA(m) Cables
- 4. EPLSP Cable

d) If you have a MIMO system, repeat steps a through c for the second PXIe-3620 module in the TX chassis and a second mmRH-3647.

3. Connect all mmWave radio heads to power.

**Related Information**

- [Assembling mmWave Radio Head Tripods \(mmRH-3647/3657\)](#) on page 7
- [Interconnecting the Unidirectional SISO \(Baseband and IF\) Modules](#) on page 15
- [Interconnecting the Unidirectional MIMO \(Baseband and IF\) Modules](#) on page 23

**Connecting mmWave Radio Heads to a Bidirectional System**

**Connecting mmRH-3602/3603 Radio Heads to a Bidirectional System**

Complete the following steps to connect mmRH-3602/3603 radio heads to a bidirectional mmWave Transceiver System.



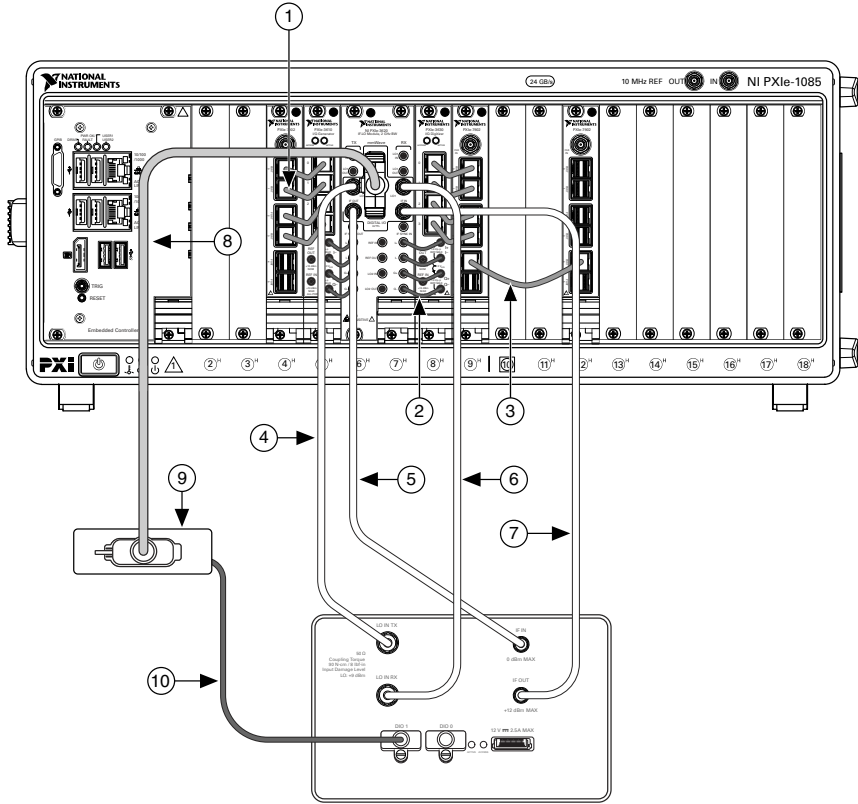
**Note** Connect the modules of the mmWave Transceiver System for standard use before connecting mmRH-3602/3603 radio heads.

1. Connect the DIGITAL I/O connector of the PXIe-3620 front panel to the DIO adapter module using an EPLSP cable.
2. Connect the DIO adapter module to the DIO 1 connector<sup>3</sup> of the mmRH-3602/3603 back panel using an HDMI(m)-to-mini-HDMI(m) cable.
3. Connect the RX LO1 connector of the PXIe-3620 front panel to the LO IN RX connector of the mmRH-3602/3603 back panel using an SMA(m)-to-SMA(m) cable.
4. Connect the RX IF IN connector of the PXIe-3620 front panel to the IF OUT connector of the mmRH-3602/3603 back panel using an SMA(m)-to-SMA(m) cable.
5. Connect the TX LO1 connector of the PXIe-3620 front panel to the LO IN TX connector of the mmRH-3602/3603 back panel using an SMA(m)-to-SMA(m) cable.
6. Connect the TX IF OUT connector of the PXIe-3620 front panel to the IF IN connector of the mmRH-3602/3603 back panel using an SMA(m)-to-SMA(m) cable.

---

<sup>3</sup> You may connect the DIO adapter module to the DIO 0 connector instead of the DIO 1 connector. The choice of connector does not affect results.

**Figure 33.** Connecting the mmRH-3602/3603 to the Bidirectional SISO (Baseband and IF) System



1. Mini-SAS HD(m)-to-Mini-SAS HD(m) (8.25 in.) Cables
2. MMPX(m)-to-MMPX(m) Cables
3. Mini-SAS HD(m)-to-Mini-SAS HD(m) (8.25 in.) Cable
4. SMA(m)-to-SMA(m) Cable
5. SMA(m)-to-SMA(m) Cable
6. SMA(m)-to-SMA(m) Cable
7. SMA(m)-to-SMA(m) Cable
8. EPLSP Cable
9. DIO Adapter Module
10. HDMI(m)-to-mini-HDMI(m) Cable

7. If you have a MIMO system, repeat steps 1 through 6 for the second PXIe-3620, PXIe-3610, and PXIe-3630 modules in the chassis, as well as an additional mmRH-3602/3603.
8. Repeat steps 1 through 8 for the second RX/TX chassis.

9. Connect all mmWave radio heads to power.

## Related Information

[Interconnecting the Bidirectional MIMO \(Baseband and IF\) Modules](#) on page 35

[Interconnecting the Bidirectional SISO \(Baseband and IF\) Modules](#) on page 29

## Connecting mmRH-3642/3643/3652/3653 Radio Heads to a Bidirectional System

Complete the following steps to connect mmRH-3642/3643/3652/3653 radio heads to a bidirectional mmWave Transceiver System.



**Note** Connect the modules of the mmWave Transceiver System for standard use before connecting mmRH-3642/3643/3652/3653 radio heads.

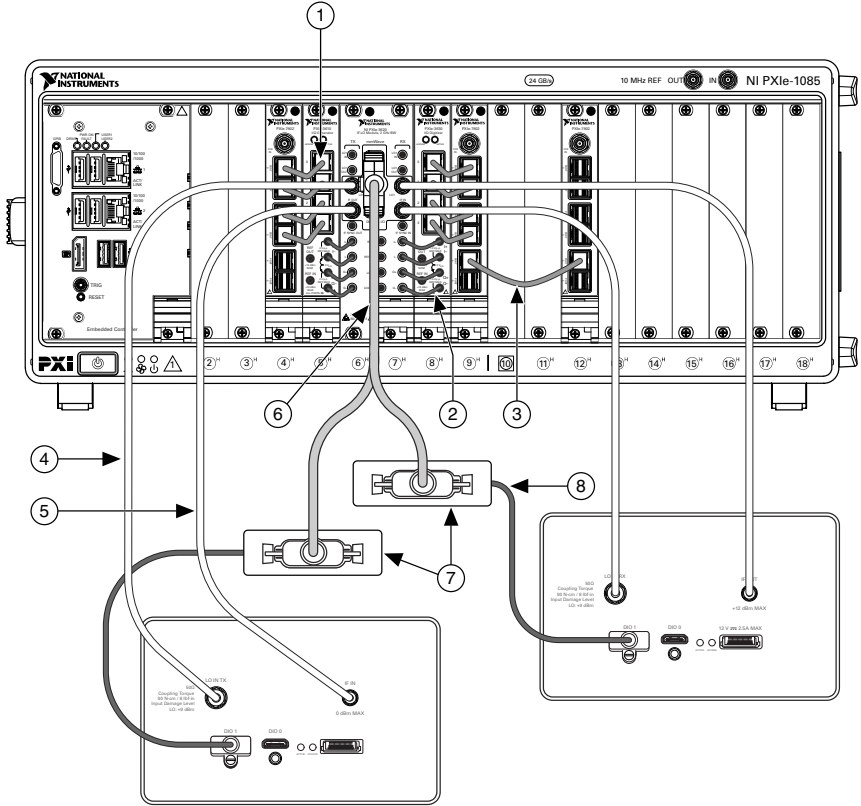
1. Connect to the DIGITAL I/O connector of the PXIe-3620 front panel using the joint end of a dual-channel EPLSP cable.
2. Connect the DIO adapter module to the DIO 1 connector<sup>4</sup> of the mmRH-3652/3653 back panel using an HDMI(m)-to-mini-HDMI(m) cable.
3. Connect the other DIO adapter module to the DIO 1 connector<sup>4</sup> of the mmRH-3642/3643 back panel using an HDMI(m)-to-mini-HDMI(m) cable.
4. Connect the RX LO1 connector of the PXIe-3620 front panel to the LO IN RX connector of the mmRH-3652/3653 back panel using an SMA(m)-to-SMA(m) cable.
5. Connect the RX IF IN connector of the PXIe-3620 front panel to the IF OUT connector of the mmRH-3652/3653 back panel using an SMA(m)-to-SMA(m) cable.
6. Connect the TX LO1 connector of the PXIe-3620 front panel to the LO IN TX connector of the mmRH-3642/3643 back panel using an SMA(m)-to-SMA(m) cable.
7. Connect the TX IF OUT connector of the PXIe-3620 front panel to the IF IN connector of the mmRH-3642/3643 back panel using an SMA(m)-to-SMA(m) cable.

---

<sup>4</sup> You may connect the DIO adapter module to the DIO 0 connector instead of the DIO 1 connector. The choice of connector does not affect results.



**Figure 34.** Connecting the mmRH-3642/3643/3652/3653 to the Bidirectional SISO (Baseband and IF) System



1. Mini-SAS HD(m)-to-Mini-SAS HD(m) (8.25 in.) Cables
  2. MMPX(m)-to-MMPX(m) Cables
  3. Mini-SAS HD(m)-to-Mini-SAS HD(m) (8.25 in.) Cable
  4. SMA(m)-to-SMA(m) Cable
  5. SMA(m)-to-SMA(m) Cable
  6. EPLSP Cable
  7. DIO Adapter Module
  8. HDMI(m)-to-mini-HDMI(m) Cable
8. If you have a MIMO system, repeat steps 1 through 7 for the second PXIe-3620, PXIe-3610, and PXIe-3630 modules in the chassis, as well as an additional mmRH-3642/3643 and mmRH-3652/3653.
  9. Repeat steps 1 through 8 for the second RX/TX chassis.
  10. Connect all mmWave radio heads to power.

## Related Information

[Interconnecting the Bidirectional MIMO \(Baseband and IF\) Modules](#) on page 35

[Interconnecting the Bidirectional SISO \(Baseband and IF\) Modules](#) on page 29

## Connecting mmRH-3647/3657 Radio Heads to a Bidirectional System

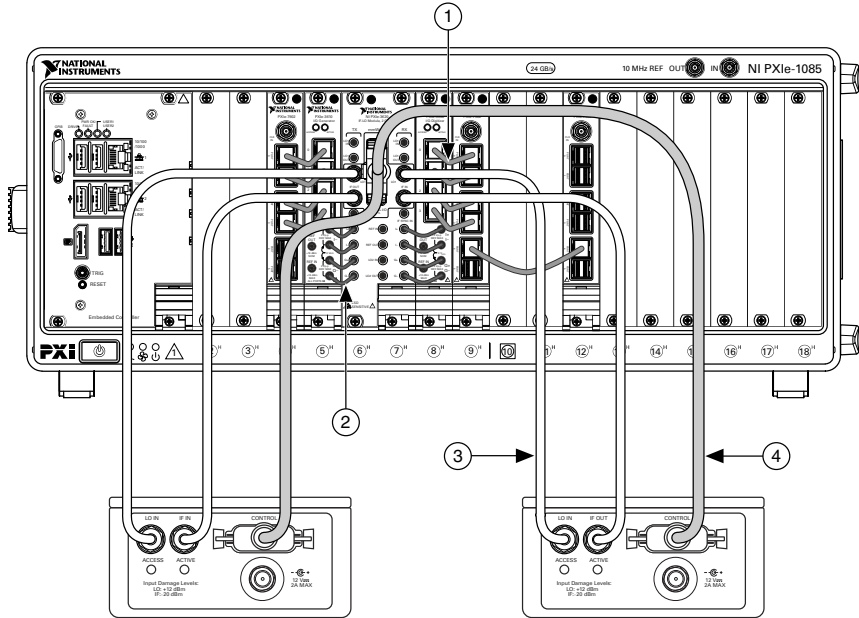
Complete the following steps to connect mmRH-3647/3657 mmWave radio heads to a bidirectional mmWave Transceiver System.



**Note** Connect the modules of the mmWave Transceiver System for standard use before connecting mmRH-3647/3657 radio heads.

1. Connect to the DIGITAL I/O connector of the PXIe-3620 front panel using the joint end of a dual-channel EPLSP cable.
2. Connect one end of the dual-channel EPLSP cable to the CONTROL connector of the mmRH-3657 back panel.
3. Connect the other end of the dual-channel EPLSP cable to the CONTROL connector of the mmRH-3647 back panel.
4. Connect the RX LO1 connector of the PXIe-3620 front panel to the LO IN connector of the mmRH-3657 back panel using an SMA(m)-to-SMA(m) cable.
5. Connect the RX IF IN connector of the PXIe-3620 front panel to the IF OUT connector of the mmRH-3657 back panel using an SMA(m)-to-SMA(m) cable.
6. Connect the TX LO1 connector of the PXIe-3620 front panel to the LO IN connector of the mmRH-3647 back panel using an SMA(m)-to-SMA(m) cable.
7. Connect the TX IF OUT connector of the PXIe-3620 front panel to the IF IN connector of the mmRH-3647 back panel using an SMA(m)-to-SMA(m) cable.

**Figure 35.** Connecting mmWave Heads to the Bidirectional SISO (Baseband and IF) System



1. Mini-SAS HD(m)-to-Mini-SAS HD(m) (8.25 in.) Cables
  2. MMPX(m)-to-MMPX(m) Cables
  3. SMA(m)-to-SMA(m) Cables
  4. Dual-channel EPLSP Cable
8. If you have a MIMO system, repeat steps 1 through 7 for the second PXIe-3620, PXIe-3610, and PXIe-3630 modules in the chassis, as well as an additional mmRH-3647 and mmRH-3657.
  9. Repeat steps 1 through 8 for the second RX/TX chassis.
  10. Connect all mmWave radio heads to power.

### Related Information

[Assembling mmWave Radio Head Tripods \(mmRH-3647/3657\)](#) on page 7

[Interconnecting the Bidirectional SISO \(Baseband and IF\) Modules](#) on page 29

[Interconnecting the Bidirectional MIMO \(Baseband and IF\) Modules](#) on page 35

## Configuring the Coding Modules of a MIMO System

Complete the following steps to continue configuring the modules if you chose to add the coding option for a MIMO mmWave Transceiver System.



**Note** Before connecting the modules for the coding option, ensure that the modules have been properly connected for standard use.

For unidirectional systems, the coding option includes one coding chassis that connects to the RX chassis. For bidirectional systems, the coding option includes two coding chassis that connect to the two RX/TX chassis. Both systems require you to move the PXIe-7902 module from slot 12 of the RX or main chassis to slot 9 of the coding chassis.



**Note** No additional cabling is necessary for the coding modules of a SISO system.



**Notice** To prevent damage to the mmWave Transceiver System caused by energy spectral density (ESD) or contamination, handle the module using the edges or the metal bracket.

1. Ensure the AC power source is connected to every chassis before removing and installing the module.

The AC power cord grounds the chassis and protects it from electrical damage while you remove and install the module.

2. Power off the chassis.
3. Remove the slot blocker from slot 9 of the coding chassis.



**Note** Do not discard the slot blocker.

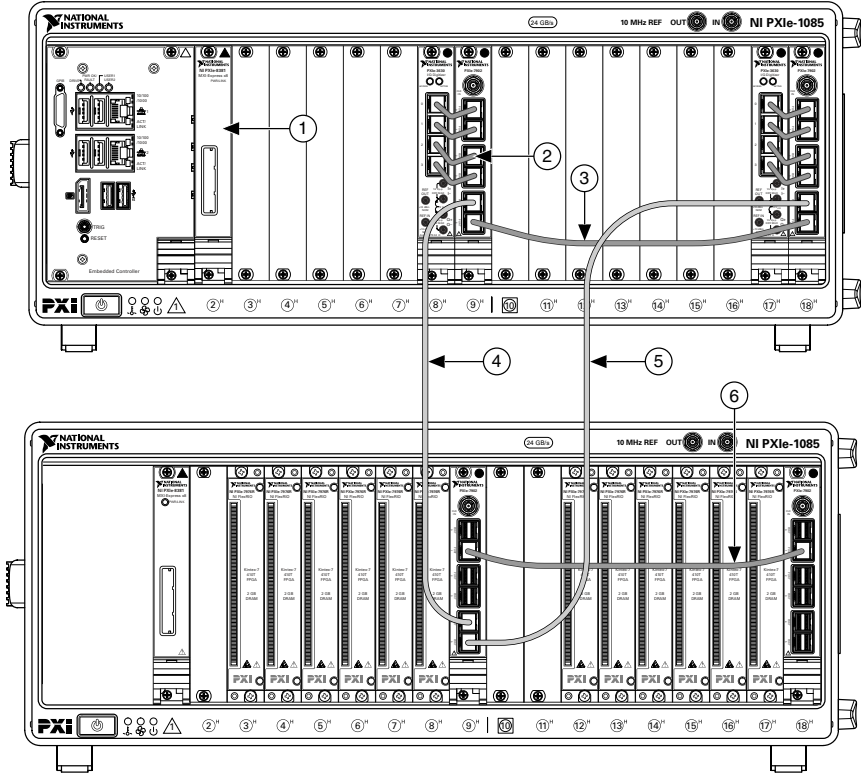
4. Locate the PXIe-7902 in slot 12 of the RX or RX/TX chassis and remove it.
  - a) Remove the Mini-SAS HD(m)-to-Mini-SAS HD(m) (8.25 in.) cables that are attached to the PXIe-7902 front panel.
  - b) (Optional) Remove the Mini-SAS HD(m)-to-Mini-SAS HD(m) (8.25 in.) cable that connects the PXIe-7902 modules in slots 9 and 18. Removing this cable makes it easier to remove the PXIe-7902 module in slot 12.
  - c) Unscrew the two bracket-retaining screws in the front panel.
  - d) Press the injector/ejector handle down.
  - e) Slide the PXIe-7902 module out of slot 12 of the chassis.
5. Fill slot 12 of the RX or RX/TX chassis using the slot blocker you removed in step 3.
6. Locate the empty slot in slot 9 of the coding chassis and install the PXIe-7902 module you removed in step 4.
  - a) Inspect the slot pins on the chassis backplane for any bends or damage prior to installation. Do not install a module if the backplane is damaged.
  - b) Touch any metal part of the chassis to discharge static electricity.
  - c) Place the PXIe-7902 module edges into the module guides at the top and bottom of the chassis. Slide the module into the slot until it is fully inserted.
  - d) Secure the PXIe-7902 module front panel to the chassis using the front-panel mounting screws.



**Note** Tightening the top and bottom mounting screws increases mechanical stability and also electrically connects the front panel to the chassis, which can improve the signal quality and electromagnetic performance.

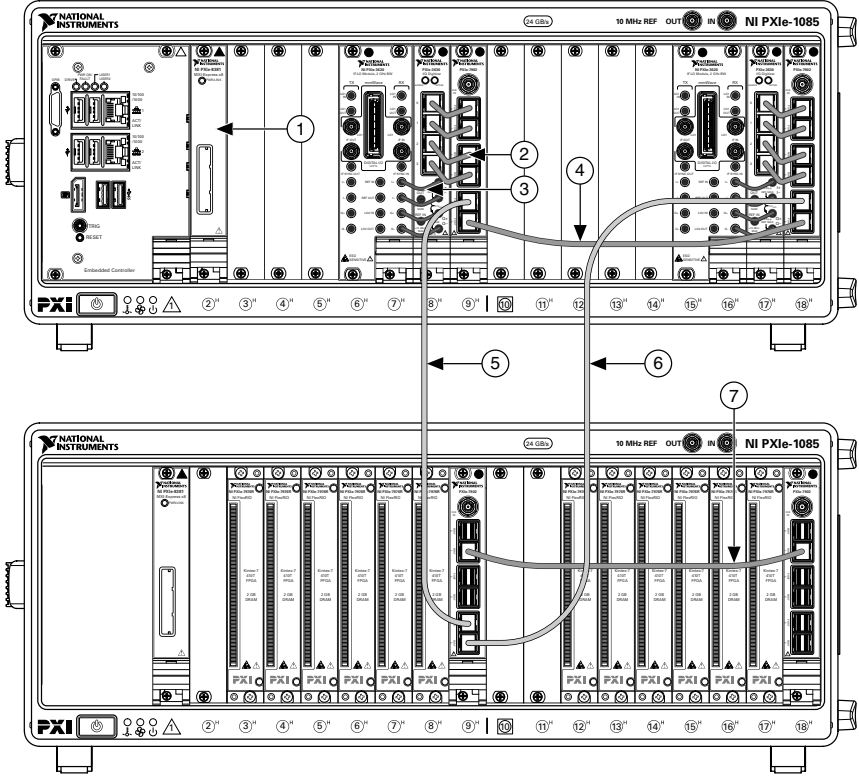
7. Reconnect the modules you disconnected in step 4.a using Mini-SAS HD(m)-to-Mini-SAS HD(m) (18 in.) cables.
  - a) Connect the PORT 4 connector of the PXIe-7902 front panel in slot 9 of the RX or RX/TX chassis to the PORT 4 connector of the PXIe-7902 front panel in slot 9 of the coding chassis.
  - b) Connect the PORT 4 connector of the PXIe-7902 front panel in slot 18 of the RX or RX/TX chassis to the PORT 5 connector of the PXIe-7902 front panel in slot 9 of the coding chassis.
8. If you chose to remove the third cable in step 4.b, replace it now by using a Mini-SAS HD(m)-to-Mini-SAS HD(m) (8.25 in.) cable to connect the PORT 5 connector of the PXIe-7902 front panel in slot 9 of the RX or RX/TX chassis to the PORT 5 connector of the PXIe-7902 front panel in slot 18 of the RX or RX/TX chassis.
9. Connect the PORT 1 connector of the PXIe-7902 front panel in slot 9 of the coding chassis to the PORT 1 connector of the PXIe-7902 front panel in slot 18 of the coding chassis using a Mini-SAS HD(m)-to-Mini-SAS HD(m) (8.25 in.) cable.
10. Power on the chassis.
11. If you have a bidirectional system, repeat steps 1 through 10 for the second set of chassis.

**Figure 36.** Interconnecting the Unidirectional MIMO (Baseband) RX Chassis to the Coding Chassis



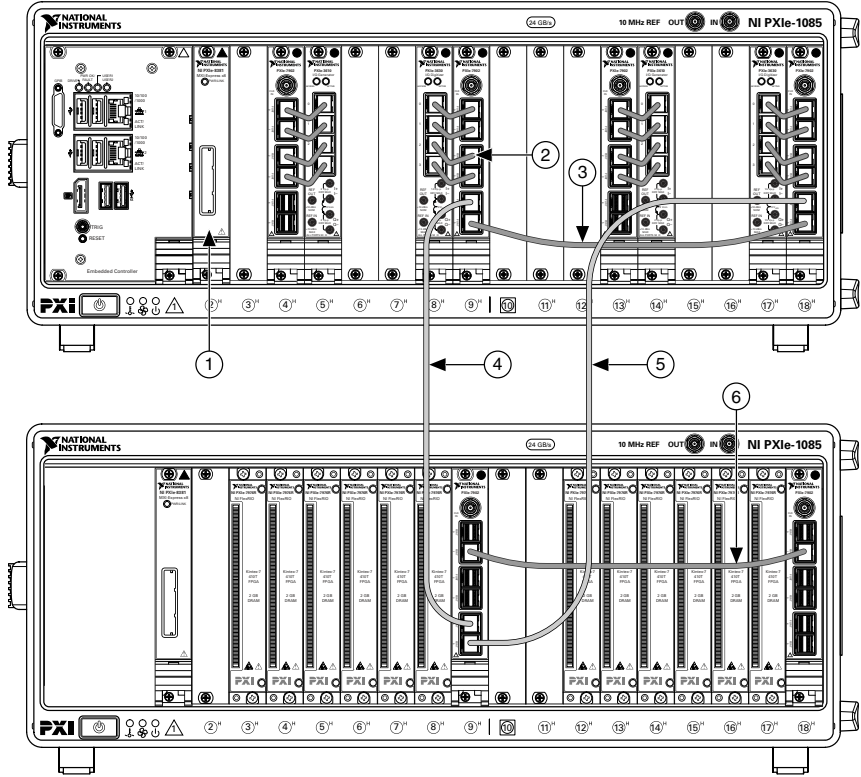
- |                                                                                                                                                                                                                   |                                                                                                                                                                                                                                |
|-------------------------------------------------------------------------------------------------------------------------------------------------------------------------------------------------------------------|--------------------------------------------------------------------------------------------------------------------------------------------------------------------------------------------------------------------------------|
| <ol style="list-style-type: none"> <li>1. PXIe-8381 Remote Control Module</li> <li>2. Mini-SAS HD(m)-to-Mini-SAS HD(m) (8.25 in.) Cables</li> <li>3. Mini-SAS HD(m)-to-Mini-SAS HD(m) (8.25 in.) Cable</li> </ol> | <ol style="list-style-type: none"> <li>4. Mini-SAS HD(m)-to-Mini-SAS HD(m) (18 in.) Cable</li> <li>5. Mini-SAS HD(m)-to-Mini-SAS HD(m) (18 in.) Cable</li> <li>6. Mini-SAS HD(m)-to-Mini-SAS HD(m) (8.25 in.) Cable</li> </ol> |
|-------------------------------------------------------------------------------------------------------------------------------------------------------------------------------------------------------------------|--------------------------------------------------------------------------------------------------------------------------------------------------------------------------------------------------------------------------------|

**Figure 37. Interconnecting the Unidirectional MIMO (Baseband and IF) RX Chassis to the Coding Chassis**



- |                                                                                                                                                                                                                                                         |                                                                                                                                                                                                                                |
|---------------------------------------------------------------------------------------------------------------------------------------------------------------------------------------------------------------------------------------------------------|--------------------------------------------------------------------------------------------------------------------------------------------------------------------------------------------------------------------------------|
| <ul style="list-style-type: none"> <li>1. PXIe-8381 Remote Control Module</li> <li>2. Mini-SAS HD(m)-to-Mini-SAS HD(m) (8.25 in.) Cables</li> <li>3. MMPX(m)-to-MMPX(m) Cables</li> <li>4. Mini-SAS HD(m)-to-Mini-SAS HD(m) (8.25 in.) Cable</li> </ul> | <ul style="list-style-type: none"> <li>5. Mini-SAS HD(m)-to-Mini-SAS HD(m) (18 in.) Cable</li> <li>6. Mini-SAS HD(m)-to-Mini-SAS HD(m) (18 in.) Cable</li> <li>7. Mini-SAS HD(m)-to-Mini-SAS HD(m) (8.25 in.) Cable</li> </ul> |
|---------------------------------------------------------------------------------------------------------------------------------------------------------------------------------------------------------------------------------------------------------|--------------------------------------------------------------------------------------------------------------------------------------------------------------------------------------------------------------------------------|

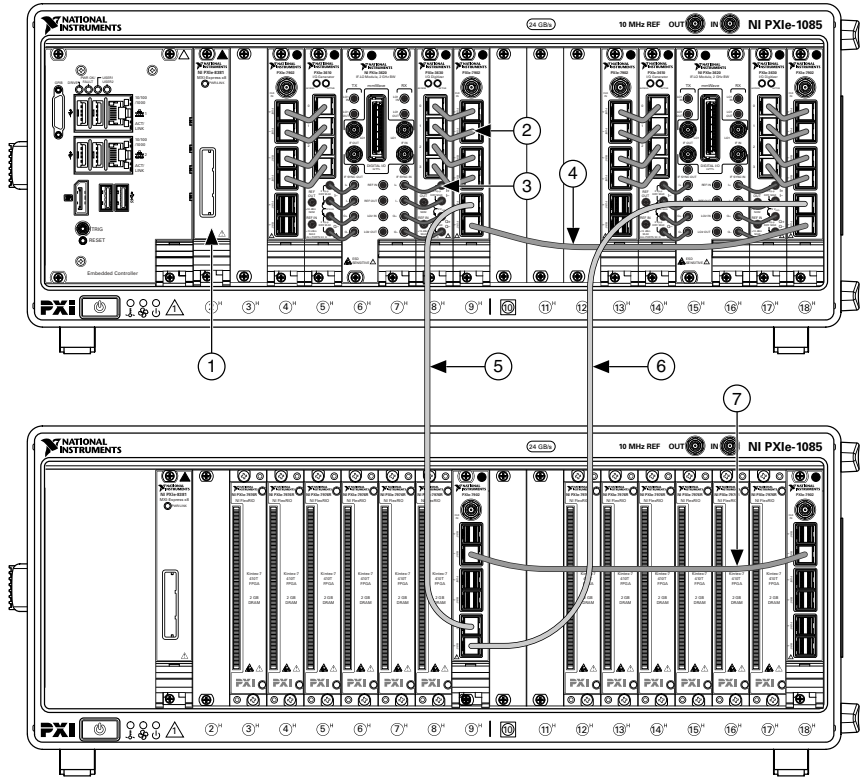
**Figure 38.** Interconnecting the Bidirectional MIMO (Baseband) Chassis to the Coding Chassis



- |                                                                                                                                                                                                                   |                                                                                                                                                                                                                                |
|-------------------------------------------------------------------------------------------------------------------------------------------------------------------------------------------------------------------|--------------------------------------------------------------------------------------------------------------------------------------------------------------------------------------------------------------------------------|
| <ol style="list-style-type: none"> <li>1. PXIe-8381 Remote Control Module</li> <li>2. Mini-SAS HD(m)-to-Mini-SAS HD(m) (8.25 in.) Cables</li> <li>3. Mini-SAS HD(m)-to-Mini-SAS HD(m) (8.25 in.) Cable</li> </ol> | <ol style="list-style-type: none"> <li>4. Mini-SAS HD(m)-to-Mini-SAS HD(m) (18 in.) Cable</li> <li>5. Mini-SAS HD(m)-to-Mini-SAS HD(m) (18 in.) Cable</li> <li>6. Mini-SAS HD(m)-to-Mini-SAS HD(m) (8.25 in.) Cable</li> </ol> |
|-------------------------------------------------------------------------------------------------------------------------------------------------------------------------------------------------------------------|--------------------------------------------------------------------------------------------------------------------------------------------------------------------------------------------------------------------------------|



**Figure 39.** Interconnecting the Bidirectional MIMO (Baseband and IF) Chassis to the Coding Chassis



- |                                                       |                                                      |
|-------------------------------------------------------|------------------------------------------------------|
| 1. PXIe-8381 Remote Control Module                    | 5. Mini-SAS HD(m)-to-Mini-SAS HD(m) (18 in.) Cable   |
| 2. Mini-SAS HD(m)-to-Mini-SAS HD(m) (8.25 in.) Cables | 6. Mini-SAS HD(m)-to-Mini-SAS HD(m) (18 in.) Cable   |
| 3. MMPX(m)-to-MMPX(m) Cables                          | 7. Mini-SAS HD(m)-to-Mini-SAS HD(m) (8.25 in.) Cable |
| 4. Mini-SAS HD(m)-to-Mini-SAS HD(m) (8.25 in.) Cable  |                                                      |

## Related Information

[Interconnecting the Unidirectional MIMO \(Baseband\) Modules](#) on page 19

[Interconnecting the Unidirectional MIMO \(Baseband and IF\) Modules](#) on page 23

[Interconnecting the Bidirectional MIMO \(Baseband and IF\) Modules](#) on page 35

[Interconnecting the Bidirectional MIMO \(Baseband\) Modules](#) on page 32

# Programming the mmWave Transceiver System

---

You can use the NI-mmWave instrument driver to create communications applications for the mmWave Transceiver System.

The NI-mmWave APIs are used to control the PXIe-3610, PXIe-3620, and PXIe-3630 modules as well as the mmWave radio heads.

## Related Information

[Installing the Software](#) on page 7

[Refer to the NI-mmWave Manual on ni.com for information about using the instrument driver in your applications.](#)

## NI-mmWave Instrument Driver

NI-mmWave features a set of VIs that exercise the functionality of the mmWave Transceiver System, including configuration, control, and other device-specific functions.

The NI-mmWave APIs are available in LabVIEW on the LabVIEW Functions palette at **Instrument I/O»Instrument Drivers»NI mmWave**.

## NI-mmWave Examples

The NI-mmWave instrument driver examples are instructional tools that demonstrate some of the functionality of the mmWave Transceiver System. You can use these examples separately or integrate them into your systems. NI-mmWave includes examples for getting started and other software-defined radio (SDR) functionality.

You can access the NI-mmWave examples at `<NIDIR>\LabVIEW <year>\examples\instr\niMmWave`.

## NI-mmWave Reference Project

NI-mmWave includes a reference project that you can use as a starting point for application development.

You can find this reference project at `<NIDIR>\LabVIEW <year>\examples\instr\niMmWave\niMmWave Reference Project\niMmWave Reference Project.lvproj`.

## Related Information

[Refer to the NI-mmWave Manual on ni.com for information about using the reference project.](#)

## Trigger Configuration

---



**Notice** Modifying or reserving system-required PXI triggers will cause runtime synchronization errors and prohibit system function.

**Table 7. Trigger Configuration**

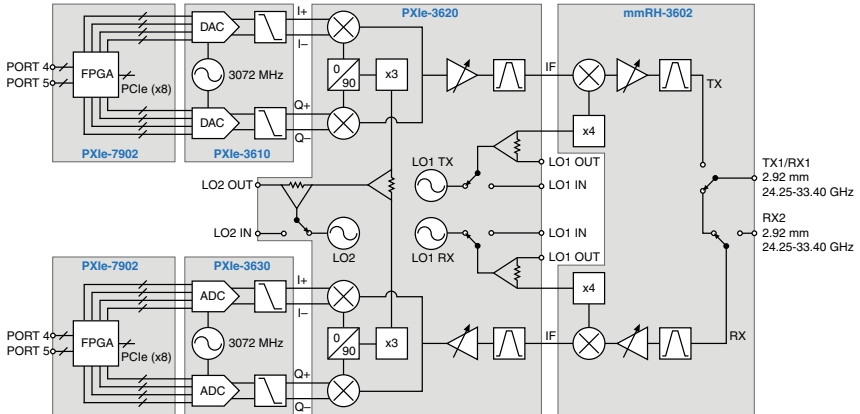
| Trigger Configuration                                                                                           | Chassis                                                                                                                                                                                                                                                                                                                                                                                                                                                                                                                                                                                                                                                                    |
|-----------------------------------------------------------------------------------------------------------------|----------------------------------------------------------------------------------------------------------------------------------------------------------------------------------------------------------------------------------------------------------------------------------------------------------------------------------------------------------------------------------------------------------------------------------------------------------------------------------------------------------------------------------------------------------------------------------------------------------------------------------------------------------------------------|
| (TX) PXIe-7902 and PXIe-3610 must be located on the same bus segment.                                           | <ul style="list-style-type: none"> <li>• Bidirectional MIMO (Baseband) RX/TX (x2)</li> <li>• Bidirectional SISO (Baseband) RX/TX (x2)</li> <li>• Bidirectional MIMO (Baseband and IF) RX/TX (x2)</li> <li>• Bidirectional SISO (Baseband and IF) RX/TX (x2)</li> <li>• Unidirectional MIMO (Baseband) TX</li> <li>• Unidirectional SISO (Baseband) TX</li> <li>• Unidirectional MIMO (Baseband and IF) TX</li> <li>• Unidirectional SISO (Baseband and IF) TX</li> </ul>                                                                                                                                                                                                   |
| (RX) PXIe-7902 and PXIe-3630 must be located on the same bus segment.                                           | <ul style="list-style-type: none"> <li>• Bidirectional MIMO (Baseband) RX/TX (x2)</li> <li>• Bidirectional SISO (Baseband) RX/TX (x2)</li> <li>• Bidirectional MIMO (Baseband and IF) RX/TX (x2)</li> <li>• Bidirectional SISO (Baseband and IF) RX/TX (x2)</li> <li>• Unidirectional MIMO (Baseband) RX</li> <li>• Unidirectional SISO (Baseband) RX</li> </ul>                                                                                                                                                                                                                                                                                                           |
| PXI_Trig4, PXI_Trig5, PXI_Trig6, and PXI_Trig7 are a reserved trigger line. Do not configure the trigger lines. | <ul style="list-style-type: none"> <li>• Bidirectional MIMO (Baseband) RX/TX (x2)</li> <li>• Bidirectional SISO (Baseband) RX/TX (x2)</li> <li>• Bidirectional MIMO (Baseband and IF) RX/TX (x2)</li> <li>• Bidirectional SISO (Baseband and IF) RX/TX (x2)</li> <li>• Unidirectional MIMO (Baseband) RX</li> <li>• Unidirectional MIMO (Baseband) TX</li> <li>• Unidirectional SISO (Baseband) RX</li> <li>• Unidirectional SISO (Baseband) TX</li> <li>• Unidirectional MIMO (Baseband and IF) RX</li> <li>• Unidirectional MIMO (Baseband and IF) TX</li> <li>• Unidirectional SISO (Baseband and IF) RX</li> <li>• Unidirectional SISO (Baseband and IF) TX</li> </ul> |
| PXIe-7902, PXIe-3630, and PXIe-3620 must be located on the same bus segment.                                    | <ul style="list-style-type: none"> <li>• Bidirectional MIMO (Baseband and IF) RX/TX (x2)</li> <li>• Unidirectional MIMO (Baseband and IF) RX</li> <li>• Unidirectional SISO (Baseband and IF) RX</li> </ul>                                                                                                                                                                                                                                                                                                                                                                                                                                                                |

**Related Information**

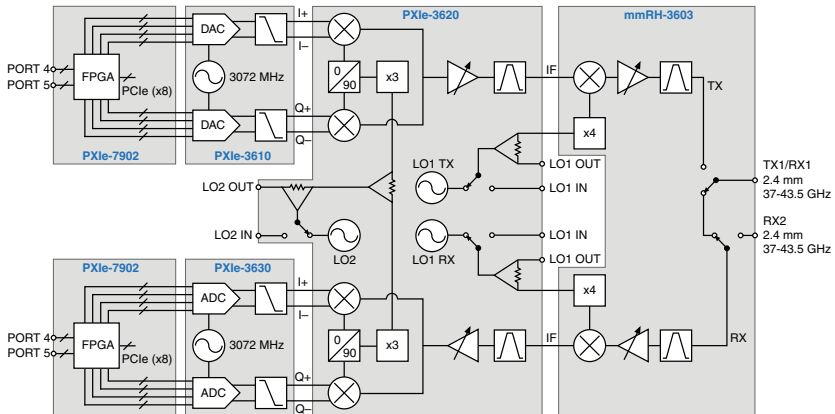
*Refer to the [NI-mmWave Manual on ni.com](#) for more information about trigger routing.*

# Signal Block Diagrams

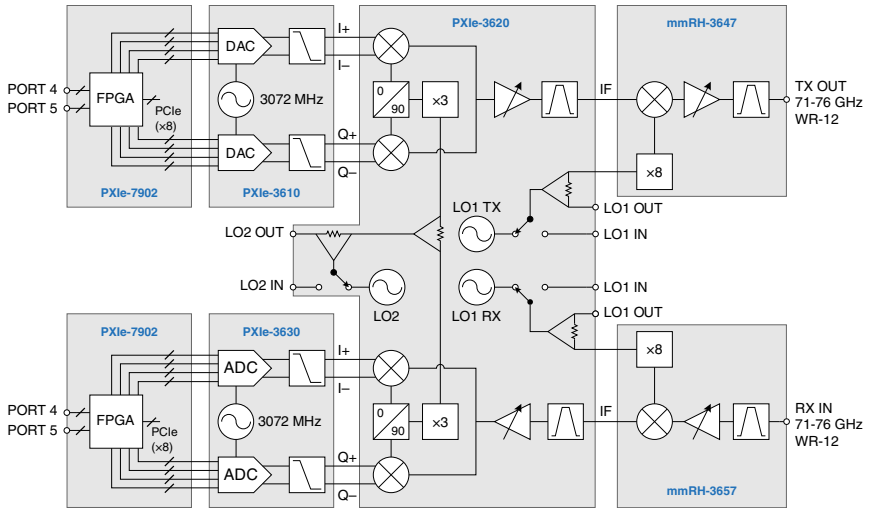
## 24.25 GHz to 33.40 GHz mmWave Transceiver System Block Diagram



## 37 GHz to 43.5 GHz mmWave Transceiver System Block Diagram



# 71 GHz to 76 GHz mmWave Transceiver System Block Diagram



## Front Panels, Back Panels, and Connectors

### Direct Connections to the mmWave Transceiver System

The mmWave Transceiver System is a precision RF instrument that is sensitive to ESD and transients. Ensure you are making proper direct connections to the mmWave Transceiver System to avoid damaging the device.



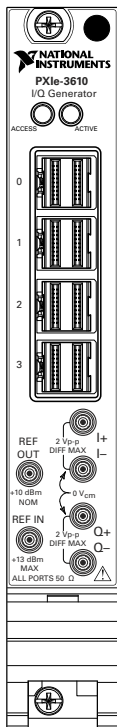
**Notice** Apply external signals only while the mmWave Transceiver System is powered on. Applying external signals while the device is powered off may cause damage.

To prevent possible damage to the device, use caution when connecting signal sources and RF antennas directly to the TX LO1, TX IF OUT, RX LO1, and RX IF IN connectors of the mmWave Transceiver System. Operators, technicians, and all other users should ensure they are properly grounded when manipulating cables or antennas connected to the mmWave Transceiver System TX LO1, TX IF OUT, RX LO1, and RX IF IN connectors.

If you are using noninsulated devices, such as a noninsulated RF antenna, ensure the devices are maintained in a static-free environment. If you are using an active device, such as a preamplifier or switch routed to the mmWave Transceiver System TX LO1, TX IF OUT, RX LO1, and RX IF IN connectors, ensure that the device cannot generate signal transients

greater than the RF and DC specifications of the mmWave Transceiver System TX LO1, TX IF OUT, RX LO1, and RX IF IN connectors.

## PXIe-3610 Front Panel and LEDs



**Table 8.** Connector Descriptions

| Connector | Description                                                                                                                                                                                               |
|-----------|-----------------------------------------------------------------------------------------------------------------------------------------------------------------------------------------------------------|
| 0         | Digital connector for the in-phase/quadrature (I/Q) data. Must be connected to the PXIe-7902.                                                                                                             |
| 1         | Digital connector for the I/Q data. Must be connected to the PXIe-7902.                                                                                                                                   |
| 2         | Digital connector for the I/Q data. Must be connected to the PXIe-7902.                                                                                                                                   |
| 3         | Digital connector for the I/Q data. Must be connected to the PXIe-7902.                                                                                                                                   |
| REF OUT   | Output terminal for an external reference signal for the sampling clock of the device. REF OUT is an MMPX (f) connector with 96 MHz output. The output is not always active and must first be configured. |

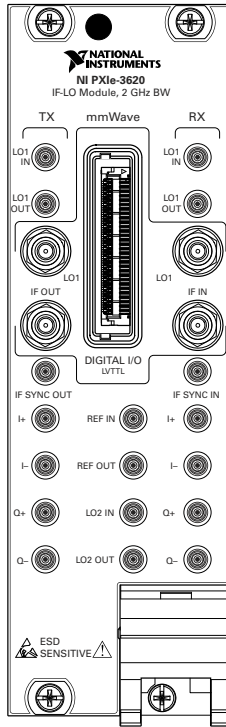
**Table 8. Connector Descriptions (Continued)**

| Connector | Description                                                                                                                                                            |                                                                                                                                                                                                                                                                                                                                                                                                                          |
|-----------|------------------------------------------------------------------------------------------------------------------------------------------------------------------------|--------------------------------------------------------------------------------------------------------------------------------------------------------------------------------------------------------------------------------------------------------------------------------------------------------------------------------------------------------------------------------------------------------------------------|
| REF IN    | Currently unsupported. Input terminal for an external reference signal for the sampling clock of the device. Use the PXI_100 backplane reference as a reference input. |                                                                                                                                                                                                                                                                                                                                                                                                                          |
| I+        | Positive digital-to-analog converter (DAC) output of the I component.                                                                                                  | Outputs are MMPX (f) connectors with 50 $\Omega$ output impedance. Both I+/- and Q+/- components are defined into a differential 100 $\Omega$ load with a common mode voltage of 0 V. For single-ended orientation, use the positive output while providing 50 $\Omega$ termination to the negative component. When connecting to the PXIe-3620, connect MMPX (m)-to-MMPX (m) cables to the corresponding TX connectors. |
| I-        | Negative DAC output of the I component.                                                                                                                                |                                                                                                                                                                                                                                                                                                                                                                                                                          |
| Q+        | Positive DAC output of the Q component.                                                                                                                                |                                                                                                                                                                                                                                                                                                                                                                                                                          |
| Q-        | Negative DAC output of the Q component.                                                                                                                                |                                                                                                                                                                                                                                                                                                                                                                                                                          |

**Table 9. LED Indicators**

| LED    | Description                                        | Color  | State    | Indication                                         |
|--------|----------------------------------------------------|--------|----------|----------------------------------------------------|
| ACCESS | Indicates if the DAC within the module is powered. | OFF    | —        | The DAC is not powered.                            |
|        |                                                    | Green  | Solid    | The DAC is powered and ready for normal operation. |
| ACTIVE | Indicates the configuration status of the module.  | OFF    | —        | The DAC is not powered.                            |
|        |                                                    | Yellow | Blinking | The module is being configured.                    |
|        |                                                    | Green  | Solid    | The DAC is operating.                              |

# PXIe-3620 Front Panel



**Table 10.** Connector Descriptions

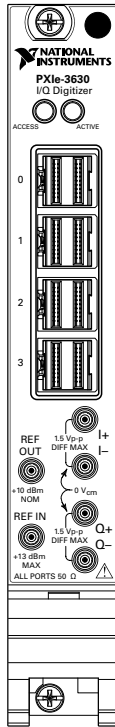
| Connector |             |        | Description                                   |
|-----------|-------------|--------|-----------------------------------------------|
| mmWave    | TX          | LO1    | LO1 output for tuning the mmWave radio head.  |
|           |             | IF OUT | IF output to the mmWave radio head.           |
|           | DIGITAL I/O |        | Digital I/O to control the mmWave radio head. |
|           | RX          | LO1    | LO1 output for tuning the mmWave radio head.  |
|           |             | IF IN  | IF input from the mmWave radio head.          |



**Table 10. Connector Descriptions (Continued)**

| Connector |             | Description                                                                                       |
|-----------|-------------|---------------------------------------------------------------------------------------------------|
| TX        | LO1 IN      | LO1 input that allows sharing of the LO1 associated with the transmitting the mmWave radio head.  |
|           | LO1 OUT     | LO1 output that allows sharing of the LO1 associated with the transmitting the mmWave radio head. |
|           | IF SYNC OUT | Internally connected to the IF OUT port through a single-pole, double-throw (SPDT) switch.        |
|           | I+          | I+ and I- comprise the 100 $\Omega$ differential input for the in-phase signal.                   |
|           | I-          |                                                                                                   |
|           | Q+          | Q+ and Q- comprise the 100 $\Omega$ differential input for the quadrature-phase signal.           |
|           | Q-          |                                                                                                   |
| RX        | LO1 IN      | LO1 input that allows sharing of the LO1 associated with the receiving the mmWave radio head.     |
|           | LO1 OUT     | LO1 output that allows sharing of the LO1 associated with the receiving the mmWave radio head.    |
|           | IF SYNC IN  | Internally connected to the IF IN port through an SPDT switch.                                    |
|           | I+          | I+ and I- comprise the 100 $\Omega$ differential output for the in-phase signal.                  |
|           | I-          |                                                                                                   |
|           | Q+          | Q+ and Q- comprise the 100 $\Omega$ differential output for the quadrature-phase signal.          |
|           | Q-          |                                                                                                   |
| REF IN    |             | Reference input.                                                                                  |
| REF OUT   |             | Reference output.                                                                                 |
| LO2 IN    |             | LO2 input that allows sharing of the I/Q modulator and demodulator LO.                            |
| LO2 OUT   |             | LO2 output that allows sharing of the I/Q modulator and demodulator LO.                           |

# PXIe-3630 Front Panel and LEDs



**Table 11.** Connector Descriptions

| Connector | Description                                                                                                                                                                                               |
|-----------|-----------------------------------------------------------------------------------------------------------------------------------------------------------------------------------------------------------|
| 0         | Digital connector for the in-phase/quadrature (I/Q) data. Must be connected to the PXIe-7902.                                                                                                             |
| 1         | Digital connector for the I/Q data. Must be connected to the PXIe-7902.                                                                                                                                   |
| 2         | Digital connector for the I/Q data. Must be connected to the PXIe-7902.                                                                                                                                   |
| 3         | Digital connector for the I/Q data. Must be connected to the PXIe-7902.                                                                                                                                   |
| REF OUT   | Output terminal for an external reference signal for the sampling clock of the device. REF OUT is an MMPX (f) connector with 96 MHz output. The output is not always active and must first be configured. |

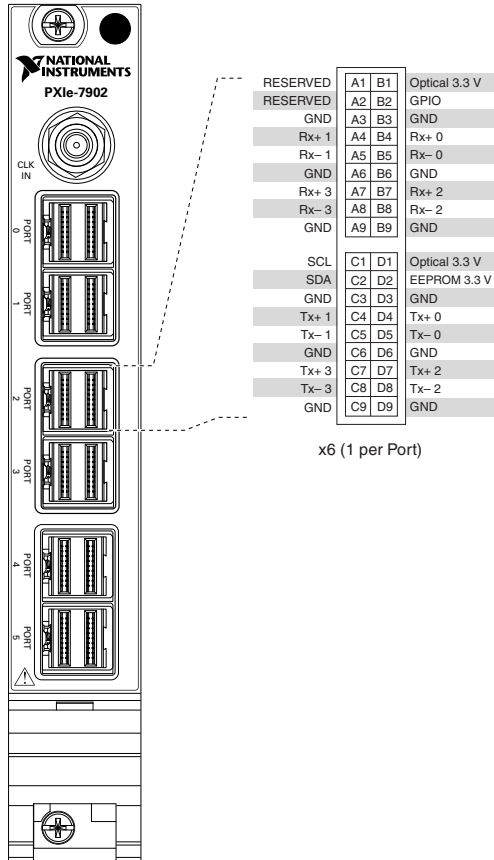
**Table 11. Connector Descriptions (Continued)**

| Connector | Description                                                                                                                                                            |                                                                                                                                                                                                                                                                                                                                                                                                                                                                           |
|-----------|------------------------------------------------------------------------------------------------------------------------------------------------------------------------|---------------------------------------------------------------------------------------------------------------------------------------------------------------------------------------------------------------------------------------------------------------------------------------------------------------------------------------------------------------------------------------------------------------------------------------------------------------------------|
| REF IN    | Currently unsupported. Input terminal for an external reference signal for the sampling clock of the device. Use the PXI_100 backplane reference as a reference input. |                                                                                                                                                                                                                                                                                                                                                                                                                                                                           |
| I+        | Differential inputs for the in-phase signal.                                                                                                                           | Inputs are MMPX (f) connectors with 50 $\Omega$ output impedance. Both I+/- and Q+/- components present a differential 100 $\Omega$ load with a common mode voltage of 0 V. For single-ended orientation, use the positive input while providing 50 $\Omega$ termination to the negative component. Differential operation is recommended for best performance. When connecting to the PXIe-3620, connect MMPX (m)-to-MMPX (m) cables to the corresponding TX connectors. |
| I-        |                                                                                                                                                                        |                                                                                                                                                                                                                                                                                                                                                                                                                                                                           |
| Q+        | Differential inputs for the quadrature-phase signal.                                                                                                                   |                                                                                                                                                                                                                                                                                                                                                                                                                                                                           |
| Q-        |                                                                                                                                                                        |                                                                                                                                                                                                                                                                                                                                                                                                                                                                           |

**Table 12. LED Indicators**

| LED    | Description                                        | Color  | State    | Indication                                         |
|--------|----------------------------------------------------|--------|----------|----------------------------------------------------|
| ACCESS | Indicates if the ADC within the module is powered. | OFF    | —        | The ADC is not powered.                            |
|        |                                                    | Green  | Solid    | The ADC is powered and ready for normal operation. |
| ACTIVE | Indicates the configuration status of the module.  | OFF    | —        | The ADC is not powered.                            |
|        |                                                    | Yellow | Blinking | The module is being configured.                    |
|        |                                                    | Green  | Solid    | The ADC is operating.                              |

# PXle-7902 Front Panel

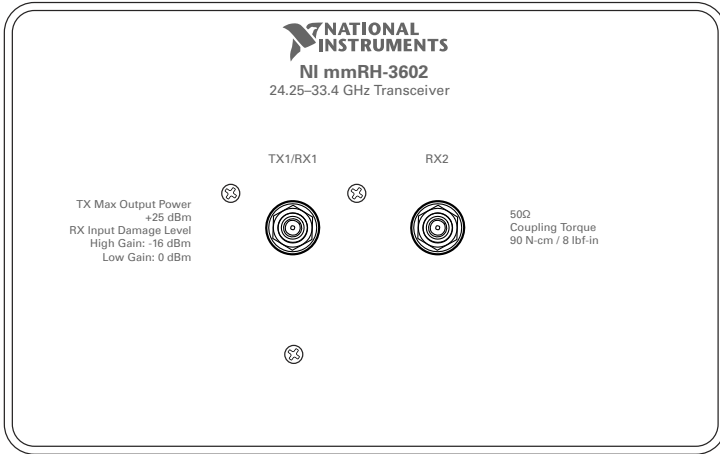


**Table 13. Connector Descriptions**

| Connector | Type        | Description                                      |
|-----------|-------------|--------------------------------------------------|
| CLK IN    | SMB         | Reference Clock input and exported clock output. |
| PORT 0-5  | Mini-SAS HD | High-speed serial interfacing ports.             |

# mmRH-3602 Front/Back Panel and LEDs

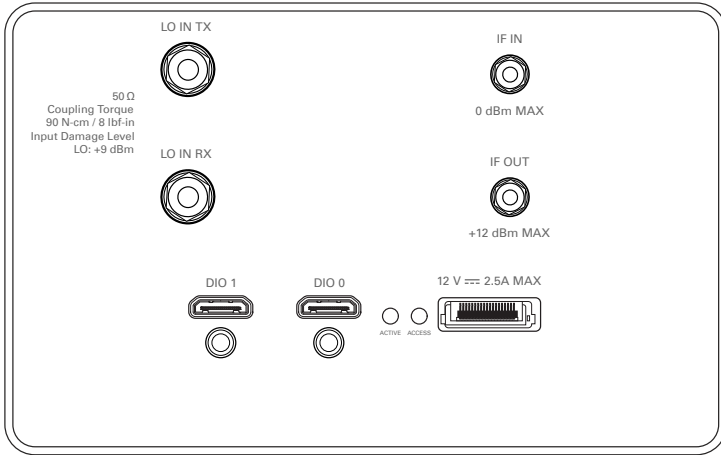
## mmRH-3602 Front Panel



**Table 14.** mmRH-3602 Front Panel Connector Descriptions

| Connector | Description                                                                                                       |
|-----------|-------------------------------------------------------------------------------------------------------------------|
| TX1/RX1   | Transmitter or receiver RF I/O, depending on the configuration.                                                   |
| RX2       | Receiver input only. This port can be used to conduct receive measurements when the TX1/RX1 port is transmitting. |

# mmRH-3602 Back Panel



**Table 15.** mmRH-3602 Back Panel Connector Descriptions

| Connector | Description                                                             |
|-----------|-------------------------------------------------------------------------|
| LO IN TX  | LO input for the transmitter.                                           |
| IF IN     | IF input for the transmitter.                                           |
| LO IN RX  | LO input for the receiver.                                              |
| IF OUT    | IF output for the receiver.                                             |
| DIO 1     | Digital I/O from the PXIe-3620 module to control the mmWave radio head. |
| DIO 0     | Digital I/O from the PXIe-3620 module to control the mmWave radio head. |
| Power     | Power supply input.                                                     |



**Note** The DIO 1 and DIO 0 ports cannot be used simultaneously.

**Table 16. mmRH-3602 Back Panel LED Indicators**

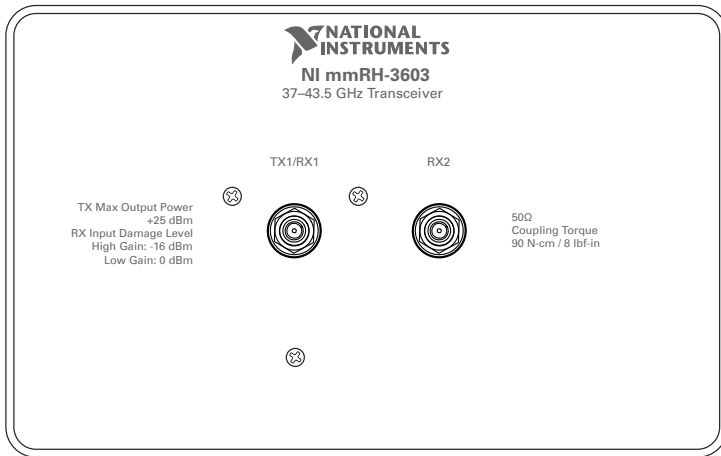
| LED    | Description                                           | Color | State             | Indication                                             |
|--------|-------------------------------------------------------|-------|-------------------|--------------------------------------------------------|
| ACCESS | Indicates if the radio head is powered.               | OFF   | —                 | The radio head is not powered.                         |
|        |                                                       | Amber | Solid or blinking | The radio head is in the process of resetting.         |
|        |                                                       | Green | Solid             | The radio head is operating.                           |
|        |                                                       | Red   | Solid             | The radio head has encountered an error.               |
| ACTIVE | Indicates the configuration status of the radio head. | OFF   | —                 | The radio head is not powered.                         |
|        |                                                       | Amber | Solid or blinking | The radio head is being configured.                    |
|        |                                                       | Green | Solid             | The radio head is powered and ready for configuration. |

**Related Information**

[Recommended Torque](#) on page 38

# mmRH-3603 Front/Back Panel and LEDs

## mmRH-3603 Front Panel

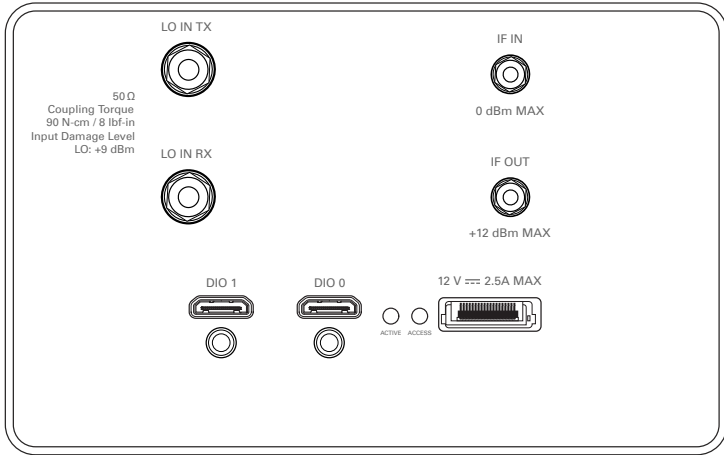


**Table 17.** mmRH-3603 Front Panel Connector Descriptions

| Connector | Description                                                                                                       |
|-----------|-------------------------------------------------------------------------------------------------------------------|
| TX1/RX1   | Transmitter or receiver RF I/O, depending on the configuration.                                                   |
| RX2       | Receiver input only. This port can be used to conduct receive measurements when the TX1/RX1 port is transmitting. |



# mmRH-3603 Back Panel



**Table 18.** mmRH-3603 Back Panel Connector Descriptions

| Connector | Description                                                             |
|-----------|-------------------------------------------------------------------------|
| LO IN TX  | LO input for the transmitter.                                           |
| IF IN     | IF input for the transmitter.                                           |
| LO IN RX  | LO input for the receiver.                                              |
| IF OUT    | IF output for the receiver.                                             |
| DIO 1     | Digital I/O from the PXIe-3620 module to control the mmWave radio head. |
| DIO 0     | Digital I/O from the PXIe-3620 module to control the mmWave radio head. |
| Power     | Power supply input.                                                     |



**Note** The DIO 1 and DIO 0 ports cannot be used simultaneously.

**Table 19. mmRH-3603 Back Panel LED Indicators**

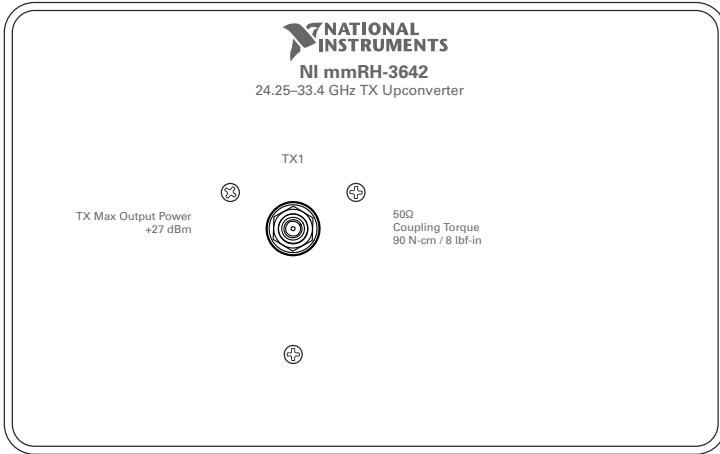
| LED    | Description                                           | Color | State             | Indication                                             |
|--------|-------------------------------------------------------|-------|-------------------|--------------------------------------------------------|
| ACCESS | Indicates if the radio head is powered.               | OFF   | —                 | The radio head is not powered.                         |
|        |                                                       | Amber | Solid or blinking | The radio head is in the process of resetting.         |
|        |                                                       | Green | Solid             | The radio head is operating.                           |
|        |                                                       | Red   | Solid             | The radio head has encountered an error.               |
| ACTIVE | Indicates the configuration status of the radio head. | OFF   | —                 | The radio head is not powered.                         |
|        |                                                       | Amber | Solid or blinking | The radio head is being configured.                    |
|        |                                                       | Green | Solid             | The radio head is powered and ready for configuration. |

### Related Information

[Recommended Torque](#) on page 38

# mmRH-3642 Front/Back Panel and LEDs

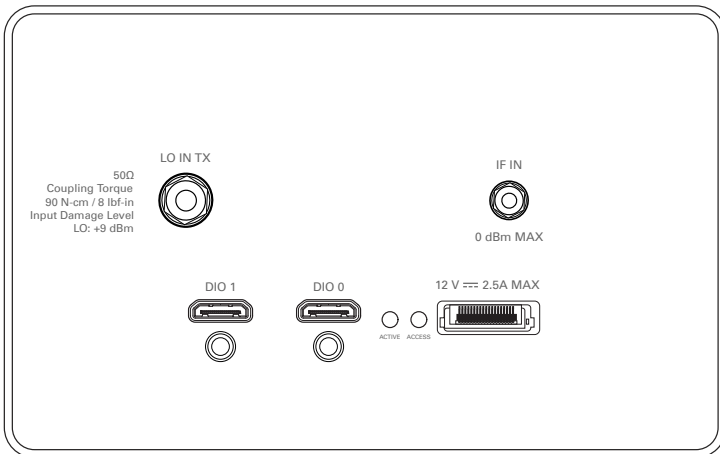
## mmRH-3642 Front Panel



**Table 20.** mmRH-3642 Front Panel Connector Descriptions

| Connector | Description         |
|-----------|---------------------|
| TX1       | Transmitter output. |

## mmRH-3642 Back Panel



**Table 21.** mmRH-3642 Back Panel Connector Descriptions

| Connector | Description                                                             |
|-----------|-------------------------------------------------------------------------|
| LO IN TX  | LO input for the transmitter.                                           |
| IF IN     | IF input for the transmitter.                                           |
| DIO 1     | Digital I/O from the PXIe-3620 module to control the mmWave radio head. |
| DIO 0     | Digital I/O from the PXIe-3620 module to control the mmWave radio head. |
| Power     | Power supply input.                                                     |



**Note** The DIO 1 and DIO 0 ports cannot be used simultaneously.

**Table 22.** mmRH-3642 Back Panel LED Indicators

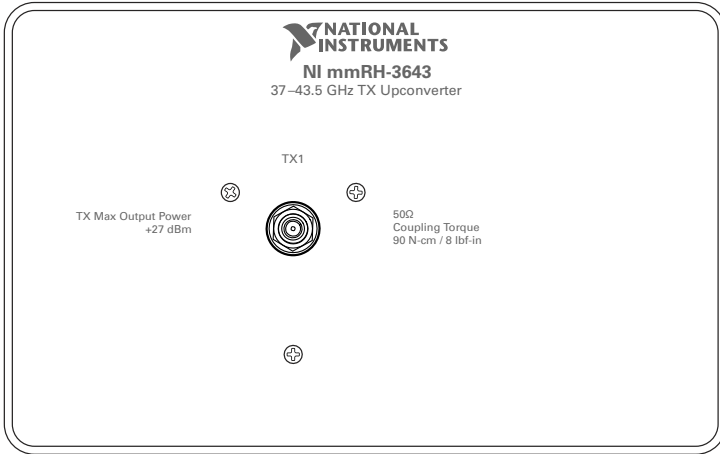
| LED    | Description                                           | Color | State             | Indication                                             |
|--------|-------------------------------------------------------|-------|-------------------|--------------------------------------------------------|
| ACCESS | Indicates if the radio head is powered.               | OFF   | —                 | The radio head is not powered.                         |
|        |                                                       | Amber | Solid or blinking | The radio head is in the process of resetting.         |
|        |                                                       | Green | Solid             | The radio head is operating.                           |
|        |                                                       | Red   | Solid             | The radio head has encountered an error.               |
| ACTIVE | Indicates the configuration status of the radio head. | OFF   | —                 | The radio head is not powered.                         |
|        |                                                       | Amber | Solid or blinking | The radio head is being configured.                    |
|        |                                                       | Green | Solid             | The radio head is powered and ready for configuration. |

## Related Information

[Recommended Torque](#) on page 38

# mmRH-3643 Front/Back Panel and LEDs

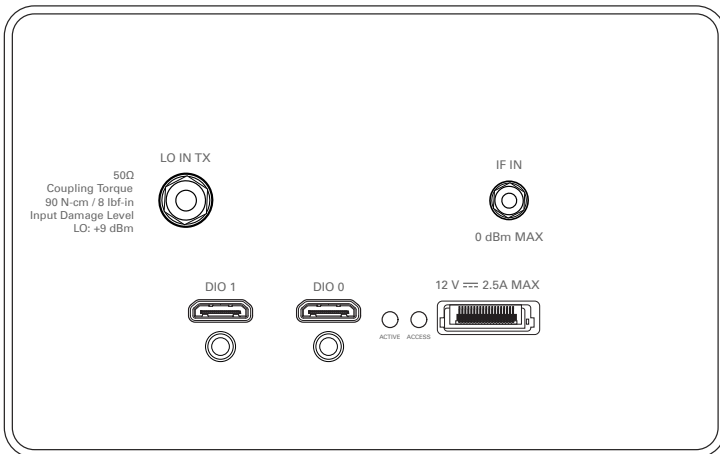
## mmRH-3643 Front Panel



**Table 23.** mmRH-3643 Front Panel Connector Descriptions

| Connector | Description         |
|-----------|---------------------|
| TX1       | Transmitter output. |

## mmRH-3643 Back Panel



**Table 24.** mmRH-3643 Back Panel Connector Descriptions

| Connector | Description                                                             |
|-----------|-------------------------------------------------------------------------|
| LO IN TX  | LO input for the transmitter.                                           |
| IF IN     | IF input for the transmitter.                                           |
| DIO 1     | Digital I/O from the PXIe-3620 module to control the mmWave radio head. |
| DIO 0     | Digital I/O from the PXIe-3620 module to control the mmWave radio head. |
| Power     | Power supply input.                                                     |



**Note** The DIO 1 and DIO 0 ports cannot be used simultaneously.

**Table 25.** mmRH-3643 Back Panel LED Indicators

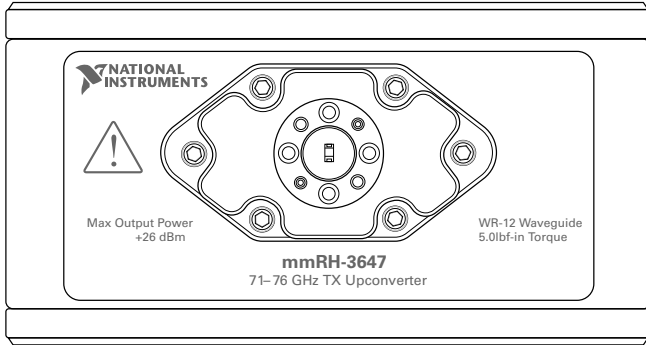
| LED    | Description                                           | Color | State             | Indication                                             |
|--------|-------------------------------------------------------|-------|-------------------|--------------------------------------------------------|
| ACCESS | Indicates if the radio head is powered.               | OFF   | —                 | The radio head is not powered.                         |
|        |                                                       | Amber | Solid or blinking | The radio head is in the process of resetting.         |
|        |                                                       | Green | Solid             | The radio head is operating.                           |
|        |                                                       | Red   | Solid             | The radio head has encountered an error.               |
| ACTIVE | Indicates the configuration status of the radio head. | OFF   | —                 | The radio head is not powered.                         |
|        |                                                       | Amber | Solid or blinking | The radio head is being configured.                    |
|        |                                                       | Green | Solid             | The radio head is powered and ready for configuration. |

## Related Information

[Recommended Torque](#) on page 38

# mmRH-3647 Front/Back Panel and LEDs

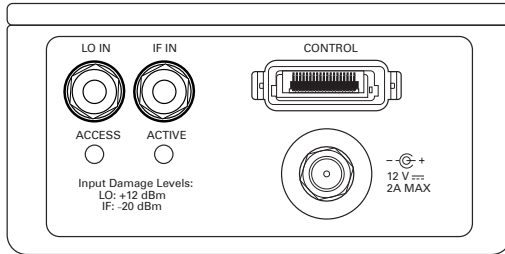
## mmRH-3647 Front Panel



**Table 26.** mmRH-3647 Front Panel Connector Descriptions

| Connector | Description            |
|-----------|------------------------|
| RF OUT    | Transmitter RF output. |

## mmRH-3647 Back Panel



**Table 27.** mmRH-3647 Back Panel Connector Descriptions

| Connector | Description                   |
|-----------|-------------------------------|
| LO IN     | LO input for the transmitter. |
| IF IN     | IF input for the transmitter. |

**Table 27.** mmRH-3647 Back Panel Connector Descriptions (Continued)

| Connector | Description                                                             |
|-----------|-------------------------------------------------------------------------|
| CONTROL   | Digital I/O from the PXIe-3620 module to control the mmWave radio head. |
| Power     | Power supply input.                                                     |

**Table 28.** mmRH-3647 Back Panel LED Indicators

| LED    | Description                                           | Color | State             | Indication                                             |
|--------|-------------------------------------------------------|-------|-------------------|--------------------------------------------------------|
| ACCESS | Indicates if the radio head is powered.               | OFF   | —                 | The radio head is not powered.                         |
|        |                                                       | Amber | Solid or blinking | The radio head is in the process of resetting.         |
|        |                                                       | Green | Solid             | The radio head is operating.                           |
|        |                                                       | Red   | Solid             | The radio head has encountered an error.               |
| ACTIVE | Indicates the configuration status of the radio head. | OFF   | —                 | The radio head is not powered.                         |
|        |                                                       | Amber | Solid or blinking | The radio head is being configured.                    |
|        |                                                       | Green | Solid             | The radio head is powered and ready for configuration. |

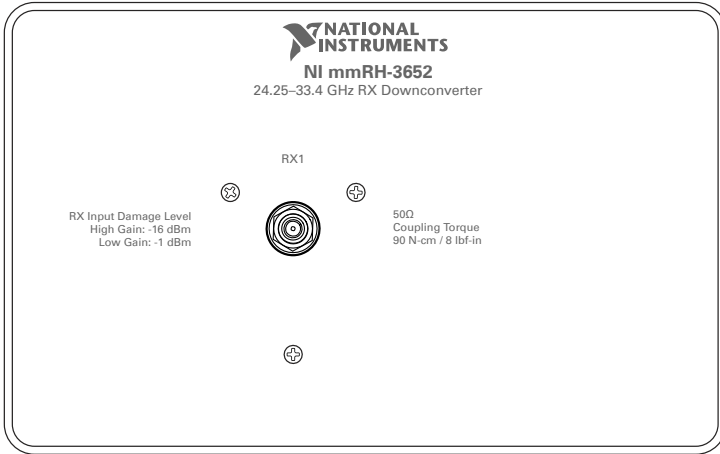
**Related Information**

[Recommended Torque](#) on page 38



# mmRH-3652 Front/Back Panel and LEDs

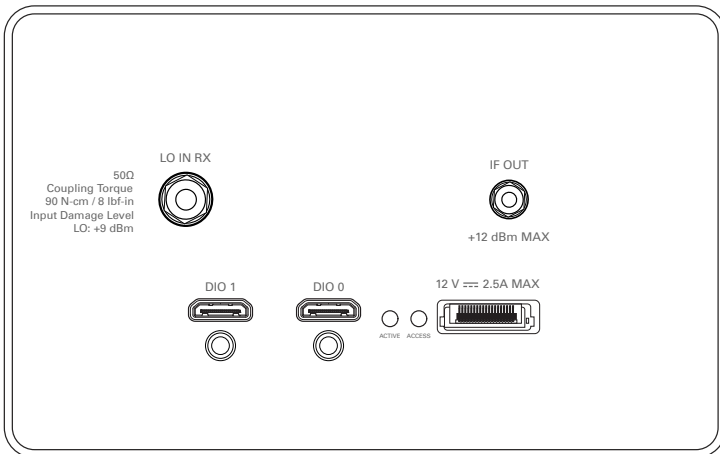
## mmRH-3652 Front Panel



**Table 29.** mmRH-3652 Front Panel Connector Descriptions

| Connector | Description        |
|-----------|--------------------|
| RX1       | Receiver RF input. |

## mmRH-3652 Back Panel



**Table 30.** mmRH-3652 Back Panel Connector Descriptions

| Connector | Description                                                             |
|-----------|-------------------------------------------------------------------------|
| LO IN RX  | LO input for the receiver.                                              |
| IF OUT    | IF output for the receiver.                                             |
| DIO 1     | Digital I/O from the PXIe-3620 module to control the mmWave radio head. |
| DIO 0     | Digital I/O from the PXIe-3620 module to control the mmWave radio head. |
| Power     | Power supply input.                                                     |



**Note** The DIO 1 and DIO 0 ports cannot be used simultaneously.

**Table 31.** mmRH-3652 Back Panel LED Indicators

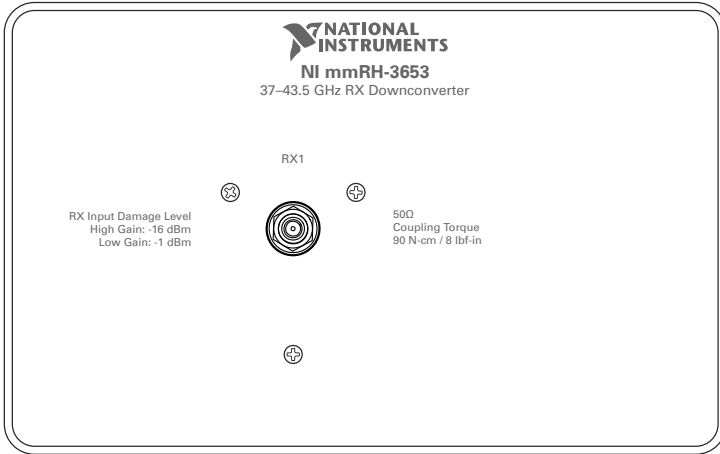
| LED    | Description                                           | Color | State             | Indication                                             |
|--------|-------------------------------------------------------|-------|-------------------|--------------------------------------------------------|
| ACCESS | Indicates if the radio head is powered.               | OFF   | —                 | The radio head is not powered.                         |
|        |                                                       | Amber | Solid or blinking | The radio head is in the process of resetting.         |
|        |                                                       | Green | Solid             | The radio head is operating.                           |
|        |                                                       | Red   | Solid             | The radio head has encountered an error.               |
| ACTIVE | Indicates the configuration status of the radio head. | OFF   | —                 | The radio head is not powered.                         |
|        |                                                       | Amber | Solid or blinking | The radio head is being configured.                    |
|        |                                                       | Green | Solid             | The radio head is powered and ready for configuration. |

## Related Information

[Recommended Torque](#) on page 38

# mmRH-3653 Front/Back Panel and LEDs

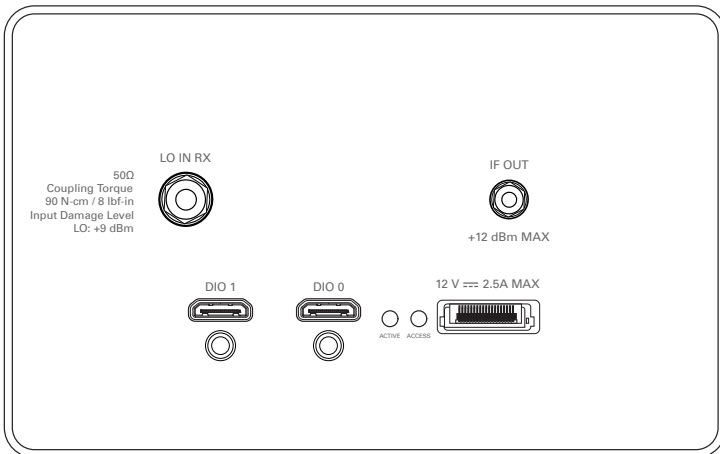
## mmRH-3653 Front Panel



**Table 32.** mmRH-3653 Front Panel Connector Descriptions

| Connector | Description        |
|-----------|--------------------|
| RX1       | Receiver RF input. |

## mmRH-3653 Back Panel



**Table 33.** mmRH-3653 Back Panel Connector Descriptions

| Connector | Description                                                             |
|-----------|-------------------------------------------------------------------------|
| LO IN RX  | LO input for the receiver.                                              |
| IF OUT    | IF output for the receiver.                                             |
| DIO 1     | Digital I/O from the PXIe-3620 module to control the mmWave radio head. |
| DIO 0     | Digital I/O from the PXIe-3620 module to control the mmWave radio head. |
| Power     | Power supply input.                                                     |



**Note** The DIO 1 and DIO 0 ports cannot be used simultaneously.

**Table 34.** mmRH-3653 Back Panel LED Indicators

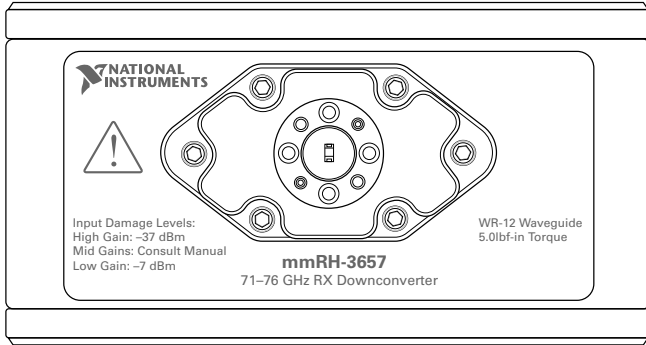
| LED    | Description                                           | Color | State             | Indication                                             |
|--------|-------------------------------------------------------|-------|-------------------|--------------------------------------------------------|
| ACCESS | Indicates if the radio head is powered.               | OFF   | —                 | The radio head is not powered.                         |
|        |                                                       | Amber | Solid or blinking | The radio head is in the process of resetting.         |
|        |                                                       | Green | Solid             | The radio head is operating.                           |
|        |                                                       | Red   | Solid             | The radio head has encountered an error.               |
| ACTIVE | Indicates the configuration status of the radio head. | OFF   | —                 | The radio head is not powered.                         |
|        |                                                       | Amber | Solid or blinking | The radio head is being configured.                    |
|        |                                                       | Green | Solid             | The radio head is powered and ready for configuration. |

## Related Information

[Recommended Torque](#) on page 38

# mmRH-3657 Front/Back Panel and LEDs

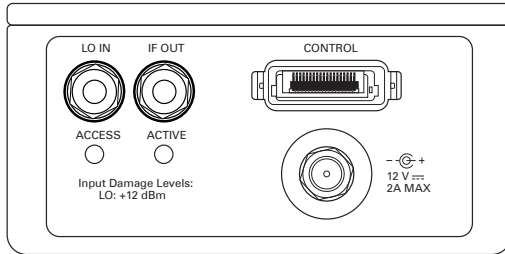
## mmRH-3657 Front Panel



**Table 35. mmRH-3657 Front Panel Connector Descriptions**

| Connector | Description        |
|-----------|--------------------|
| RF IN     | Receiver RF input. |

## mmRH-3657 Back Panel



**Table 36. mmRH-3657 Back Panel Connector Descriptions**

| Connector | Description             |
|-----------|-------------------------|
| LO IN     | LO input for receiver.  |
| IF OUT    | IF output for receiver. |

**Table 36.** mmRH-3657 Back Panel Connector Descriptions (Continued)

| Connector | Description                                                             |
|-----------|-------------------------------------------------------------------------|
| CONTROL   | Digital I/O from the PXIe-3620 module to control the mmWave radio head. |
| Power     | Power supply input.                                                     |

**Table 37.** mmRH-3657 Back Panel LED Indicators

| LED    | Description                                           | Color | State             | Indication                                             |
|--------|-------------------------------------------------------|-------|-------------------|--------------------------------------------------------|
| ACCESS | Indicates if the radio head is powered.               | OFF   | —                 | The radio head is not powered.                         |
|        |                                                       | Amber | Solid or blinking | The radio head is in the process of resetting.         |
|        |                                                       | Green | Solid             | The radio head is operating.                           |
|        |                                                       | Red   | Solid             | The radio head has encountered an error.               |
| ACTIVE | Indicates the configuration status of the radio head. | OFF   | —                 | The radio head is not powered.                         |
|        |                                                       | Amber | Solid or blinking | The radio head is being configured.                    |
|        |                                                       | Green | Solid             | The radio head is powered and ready for configuration. |

## Related Information

[Recommended Torque](#) on page 38

## Where to Go Next


Refer to the following figure for information about other product tasks and associated resources for those tasks.

Located online at [ni.com/manuals](http://ni.com/manuals)

## EXPLORE

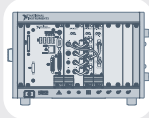
the application development environment (ADE) for your application.




 [Getting Started with LabVIEW](#)

## LEARN

about the capabilities of your hardware with device specifications.



 [mmWave Transceiver System Specifications](#)

## CREATE

custom applications with an application programming interface (API).



▶ [NI-mmWave](#)

## DISCOVER

more about your products through [ni.com](http://ni.com).



**Support**  
[ni.com/support](http://ni.com/support)



**Services**  
[ni.com/services](http://ni.com/services)



**Updates**  
[ni.com/updates](http://ni.com/updates)

Information is subject to change without notice. Refer to the *NI Trademarks and Logo Guidelines* at [ni.com/trademarks](http://ni.com/trademarks) for information on NI trademarks. Other product and company names mentioned herein are trademarks or trade names of their respective companies. For patents covering NI products/technology, refer to the appropriate location: **Help** ▶ **Patents** in your software, the `patents.txt` file on your media, or the *National Instruments Patent Notice* at [ni.com/patents](http://ni.com/patents). You can find information about end-user license agreements (EULAs) and third-party legal notices in the `readme` file for your NI product. Refer to the *Export Compliance Information* at [ni.com/legal/export-compliance](http://ni.com/legal/export-compliance) for the NI global trade compliance policy and how to obtain relevant HTS codes, ECCNs, and other import/export data. NI MAKES NO EXPRESS OR IMPLIED WARRANTIES AS TO THE ACCURACY OF THE INFORMATION CONTAINED HEREIN AND SHALL NOT BE LIABLE FOR ANY ERRORS. U.S. Government Customers: The data contained in this manual was developed at private expense and is subject to the applicable limited rights and restricted data rights as set forth in FAR 52.227-14, DFAR 252.227-7014, and DFAR 252.227-7015.

© 2017—2018 National Instruments. All rights reserved.

376531C-01 September 17, 2018