

COMPREHENSIVE SERVICES

We offer competitive repair and calibration services, as well as easily accessible documentation and free downloadable resources.

SELL YOUR SURPLUS

We buy new, used, decommissioned, and surplus parts from every NI series. We work out the best solution to suit your individual needs.

 Sell For Cash  Get Credit  Receive a Trade-In Deal

OBSOLETE NI HARDWARE IN STOCK & READY TO SHIP

We stock **New**, **New Surplus**, **Refurbished**, and **Reconditioned** NI Hardware.



Bridging the gap between the manufacturer and your legacy test system.

 1-800-915-6216

 www.apexwaves.com

 sales@apexwaves.com

All trademarks, brands, and brand names are the property of their respective owners.

Request a Quote

 **CLICK HERE**

PXIe-5645R

SPECIFICATIONS

PXIe-5645

Reconfigurable 6 GHz Vector Signal Transceiver with I/Q Interface

Contents

Definitions.....	2
Conditions.....	3
Frequency.....	4
Frequency Settling Time.....	4
Internal Frequency Reference.....	4
Frequency Reference Input (REF IN).....	5
Frequency Reference/Sample Clock Output (REF OUT).....	5
Spectral Purity.....	5
RF Input.....	7
Amplitude Range.....	7
Amplitude Settling Time.....	7
Absolute Amplitude Accuracy.....	7
Frequency Response.....	8
Average Noise Density.....	10
Spurious Responses.....	10
LO Residual Power.....	10
Residual Sideband Image.....	12
Third-Order Input Intermodulation.....	14
Second-Order Input Intermodulation.....	15
RF Output.....	15
Power Range.....	15
Amplitude Settling Time.....	16
Output Power Level Accuracy.....	16
Frequency Response.....	19
Output Noise Density.....	20
Spurious Responses.....	20
Third-Order Output Intermodulation.....	21
LO Residual Power.....	23
Residual Sideband Image.....	25
Error Vector Magnitude (EVM).....	28
VSA EVM.....	28
VSG EVM.....	28

I/Q Interface.....	29
Differential and Single-Ended Operation.....	29
I/Q Input.....	31
I/Q Output.....	42
Application-Specific Modulation Quality.....	54
RF Application-Specific Modulation Quality.....	54
I/Q Baseband Application-Specific Modulation Quality.....	56
Baseband Characteristics.....	57
Onboard FPGA.....	57
Onboard DRAM.....	58
Onboard SRAM.....	58
Front Panel I/O.....	58
RF IN.....	58
RF OUT.....	59
CAL IN, CAL OUT.....	59
LO OUT (RF IN 0 and RF OUT 0).....	59
LO IN (RF IN 0 and RF OUT 0).....	60
I/Q IN 0.....	60
I/Q OUT 0.....	61
REF IN.....	61
REF OUT.....	61
PFI 0.....	62
DIGITAL I/O.....	62
Power Requirements.....	64
Calibration.....	65
Physical Characteristics.....	65
Environment.....	65
Operating Environment.....	65
Storage Environment.....	65
Shock and Vibration.....	66
Compliance and Certifications.....	66
Safety.....	66
Electromagnetic Compatibility.....	66
CE Compliance.....	67
Online Product Certification.....	67
Environmental Management.....	67

Definitions

Warranted specifications describe the performance of a model under stated operating conditions and are covered by the model warranty.

Characteristics describe values that are relevant to the use of the model under stated operating conditions but are not covered by the model warranty.

- *Typical* specifications describe the expected performance met by a majority of the models.
- 2σ specifications describe the 95th percentile values, in which 95% of the cases are met with a 95% confidence.
- *Nominal* specifications describe parameters and attributes that may be useful in operation.

Within the specifications, self-calibration °C refers to the recorded device temperature of the last successful self-calibration.

Specifications are *Warranted* unless otherwise noted.

Conditions

Specifications are valid under the following conditions unless otherwise noted.

- 30 minutes warm-up time.
- Calibration cycle maintained.
- Chassis fan speed is set to High. In addition, NI recommends using slot blockers and EMC filler panels in empty module slots to minimize temperature drift.
- Calibration IP is used properly during the creation of custom FPGA bitfiles.
- Calibration Interconnect cable remains connected between CAL IN and CAL OUT front panel connectors.
- The cable connecting CAL IN to CAL OUT has not been removed or tampered with.
- Reference Clock source: Internal
- RF IN reference level: 0 dBm
- RF OUT power level: 0 dBm
- LO tuning mode: Fractional
- LO PLL loop bandwidth: Medium
- LO step size: 200 kHz
- LO frequency: 2.4 GHz
- LO source: Internal
- I/Q IN voltage range: $0.5 V_{\text{pk-pk}}$ differential
- I/Q IN common-mode voltage: 0 V
- I/Q OUT voltage range: $0.5 V_{\text{pk-pk}}$ differential
- I/Q OUT common-mode voltage: 0 V
- I/Q OUT load impedance: 50Ω
- Digital equalization enabled for both RF and I/Q channels

Frequency

The following characteristics are common to both RF IN and RF OUT ports.

Frequency range	65 MHz to 6 GHz
Bandwidth ¹	80 MHz
Tuning resolution ²	<1 Hz
LO step size	
Fractional mode	Programmable step size, 200 kHz default
Integer mode	4 MHz, 5 MHz, 6 MHz, 12 MHz, 24 MHz

Frequency Settling Time

Table 1. Maximum Frequency Settling Time

Settling Time	Maximum Time (ms)		
	Low Loop Bandwidth	Medium Loop Bandwidth ³ (default)	High Loop Bandwidth
$\leq 1 \times 10^{-6}$ of final frequency	1.1	0.95	0.38
$\leq 0.1 \times 10^{-6}$ of final frequency	1.2	1.05	0.4
The default medium loop bandwidth refers to a setting that adjusts PLL to balance tuning speed and phase noise, and it does not necessarily result in loop bandwidth between low and high.			
This specification includes only frequency settling and excludes any residual amplitude settling.			

Internal Frequency Reference

Initial adjustment accuracy	$\pm 200 \times 10^{-9}$
Temperature stability	$\pm 1 \times 10^{-6}$, maximum

¹ Digitally equalized RF input and RF output bandwidth. Bandwidth is restricted to 20 MHz for LO frequencies ≤ 109 MHz and restricted to 40 MHz for LO frequencies between 109 MHz and 375 MHz.

² Tuning resolution combines LO step size capability and frequency shift DSP implemented on the FPGA.

³ Medium loop bandwidth is available only in fractional mode.

Aging	$\pm 1 \times 10^{-6}$ per year, maximum
Accuracy	<i>Initial adjustment accuracy</i> \pm <i>Aging</i> \pm <i>Temperature stability</i>

Frequency Reference Input (REF IN)

Refer to the [REF IN](#) section.

Frequency Reference/Sample Clock Output (REF OUT)

Refer to the [REF OUT](#) section.

Spectral Purity

Table 2. Single Sideband Phase Noise

Frequency	Phase Noise (dBc/Hz), 20 kHz Offset (Single Sideband)		
	Low Loop Bandwidth	Medium Loop Bandwidth	High Loop Bandwidth
<3 GHz	-99	-99	-94
3 GHz to 4 GHz	-91	-93	-91
>4 GHz to 6 GHz	-93	-93	-87

Figure 1. Measured Phase Noise⁴ at 1 GHz, 2.4 GHz, and 5.8 GHz

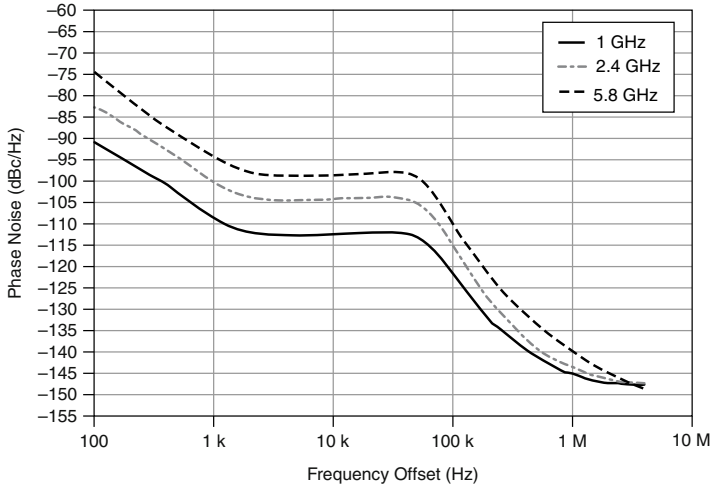
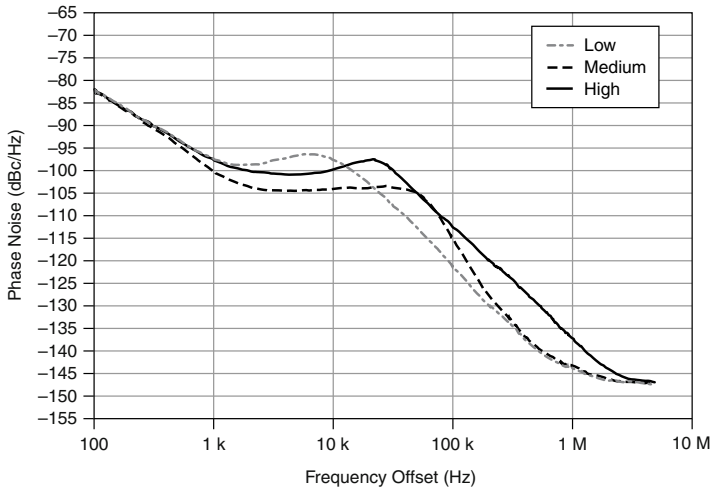

Figure 2. Measured Phase Noise⁵ at 2.4 GHz Versus Loop Bandwidth



⁴ Conditions: Measured port: LO Out; Reference Clock: internal; medium loop bandwidth.

⁵ Conditions: Measured port: LO Out; Reference Clock: internal.

RF Input

Amplitude Range

Amplitude range	Average noise level to +30 dBm (CW RMS)
RF reference level range/resolution	≥60 dB in 1 dB nominal steps

Amplitude Settling Time

<0.1 dB of final value ⁶	125 μs, typical
<0.5 dB of final value ⁷ , with LO retuned	300 μs

Absolute Amplitude Accuracy

Table 3. VSA Absolute Amplitude Accuracy (dB)

Center Frequency	15 °C to 35 °C		0 °C to 55 °C	
	Self-Calibration °C ± 1 °C	Self-Calibration °C ± 5 °C	Self-Calibration °C ± 1 °C	Self-Calibration °C ± 5 °C
65 MHz to <375 MHz	—	±0.70	—	±0.75
	—	±0.65 (95th percentile, ≈ 2σ)	—	±0.65 (95th percentile, ≈ 2σ)
	±0.34, typical	±0.50, typical	±0.36, typical	±0.55, typical
375 MHz to <2 GHz	—	±0.65	—	±0.70
	—	±0.55 (95th percentile, ≈ 2σ)	—	±0.55 (95th percentile, ≈ 2σ)
	±0.17, typical	±0.35, typical	±0.22, typical	±0.40, typical
2 GHz to <4 GHz	—	±0.70	—	±0.75
	—	±0.55 (95th percentile, ≈ 2σ)	—	±0.60 (95th percentile, ≈ 2σ)
	±0.23, typical	±0.40, typical	±0.26, typical	±0.40, typical

⁶ Constant LO frequency, constant RF input signal, varying input reference level.

⁷ LO tuning across harmonic filter bands, constant RF input signal, varying input reference level.

Table 3. VSA Absolute Amplitude Accuracy (dB) (Continued)

Center Frequency	15 °C to 35 °C		0 °C to 55 °C	
	Self-Calibration °C ± 1 °C	Self-Calibration °C ± 5 °C	Self-Calibration °C ± 1 °C	Self-Calibration °C ± 5 °C
4 GHz to 6 GHz	—	±0.90	—	±0.95
	—	±0.75 (95th percentile, ≈ 2σ)	—	±0.80 (95th percentile, ≈ 2σ)
	±0.30, typical	±0.55, typical	±0.33, typical	±0.55, typical
<p>Conditions: Reference level -30 dBm to +30 dBm; measured at 3.75 MHz offset from the configured center frequency; measurement performed after the PXIe-5645 has settled.</p> <p>For reference levels <-30 dBm, absolute amplitude gain accuracy is ±0.6 dB, typical for frequencies ≤ 4 GHz, and ±0.8 dB, typical for frequencies > 4 GHz. Performance depends on signal-to-noise ratio.</p> <p>This specification is valid only when the module is operating within the specified ambient temperature range and within the specified range from the last self-calibration temperature, as measured with the onboard temperature sensors.</p>				

Frequency Response

Table 4. VSA Frequency Response (dB) (Amplitude, Equalized)

RF Input Frequency	Bandwidth	Self-Calibration °C ± 5 °C
≤109 MHz	20 MHz	±1.0, typical
>109 MHz to 375 MHz	20 MHz	±0.5
	40 MHz	±1.0, typical
>375 MHz to 6 GHz	80 MHz	±0.5
<p>Conditions: Reference level -30 dBm to +30 dBm. This specification is valid only when the module is operating within the specified ambient temperature range and within the specified range from the last self-calibration temperature, as measured with the onboard temperature sensors.</p>		

Figure 3. Measured Frequency Response,⁸ 0 dBm Reference Level, Equalized

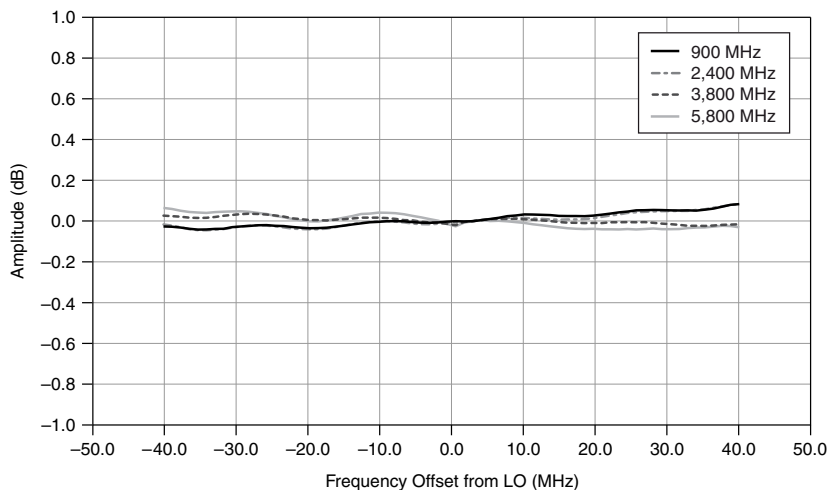
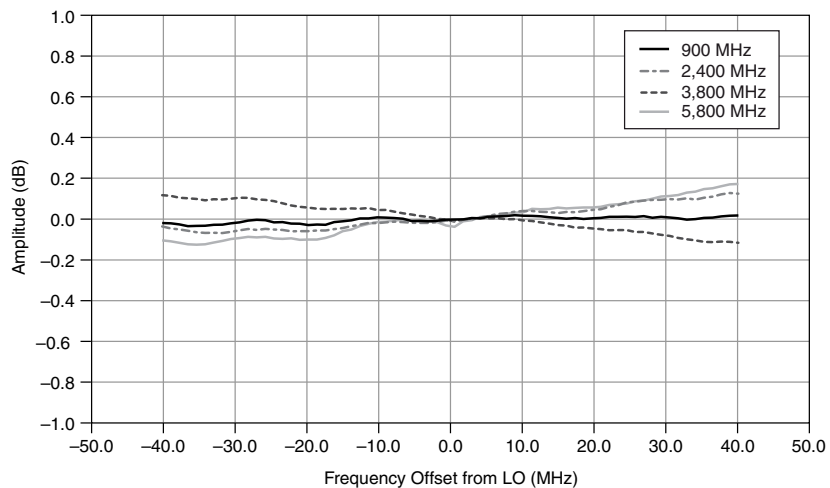

Figure 4. Measured Frequency Response,⁸ -30 dBm Reference Level, Equalized



⁸ Measurement performed after self-calibration.

Average Noise Density

Table 5. Average Noise Density (dBm/Hz)

Center Frequency	Average Noise Level	
	-50 dBm Reference Level	-10 dBm Reference Level
65 MHz to 4 GHz	-159	-145
	-161, typical	-148, typical
>4 GHz to 6 GHz	-156	-144
	-158, typical	-146, typical

Conditions: Input terminated with a 50 Ω load; 50 averages; RMS average noise level normalized to a 1 Hz noise bandwidth.

The -50 dBm reference level configuration has the inline preamplifier enabled, which represents the high sensitivity operation of the receive path.

Spurious Responses

Nonharmonic Spurs

Table 6. Nonharmonic Spurs (dBc)

Frequency	<100 kHz Offset	\geq 100 kHz Offset	>1 MHz Offset
65 MHz to 3 GHz	<-55, typical	<-60	<-75
>3 GHz to 6 GHz	<-55, typical	<-55	<-70

Conditions: Reference level \geq -30 dBm. Measured with a single tone, -1 dBr, where dBr is referenced to the configured RF reference level.

LO Residual Power

Table 7. VSA LO Residual Power (dBr⁹)

Center Frequency	Self-Calibration $^{\circ}\text{C} \pm 1 ^{\circ}\text{C}$	Self-Calibration $^{\circ}\text{C} \pm 5 ^{\circ}\text{C}$
\leq 109 MHz	—	-62
	-67, typical	-67, typical

⁹ dBr is relative to the full scale of the configured RF reference level.

Table 7. VSA LO Residual Power (dBr⁹) (Continued)

Center Frequency	Self-Calibration °C ± 1 °C	Self-Calibration °C ± 5 °C
>109 MHz to 375 MHz	—	-58
	-65, typical	-61, typical
>375 MHz to 1 GHz	—	-53
	-58, typical	-56, typical
1 GHz to 3 GHz	—	-52
	-58, typical	-56, typical
3 GHz to 4 GHz	—	-44
	-49, typical	-47, typical
4 GHz to 6 GHz	—	-43
	-48, typical	-46, typical

Conditions: Reference levels -30 dBm to +30 dBm; Measured at ADC.

This specification is valid only when the module is operating within the specified ambient temperature range and within the specified range from the last self-calibration temperature, as measured with the onboard temperature sensors.

For optimal performance, NI recommends running self-calibration when the PXIe-5645 temperature drifts ± 5 °C from the temperature at the last self-calibration. For temperature changes $\geq \pm 5$ °C from self-calibration, LO residual power is -35 dBr.

⁹ dBr is relative to the full scale of the configured RF reference level.

Figure 5. VSA LO Residual Power,¹⁰ Typical

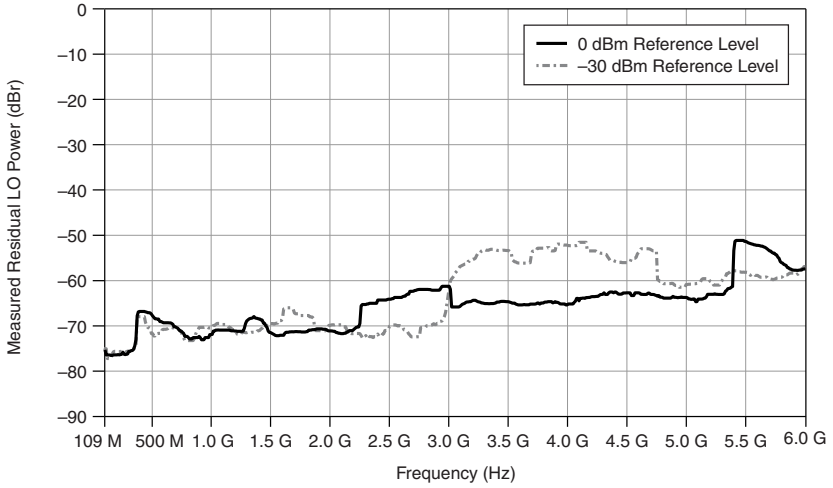

Residual Sideband Image

Table 8. VSA Residual Sideband Image, 80 MHz Bandwidth (dBc)

Center Frequency	Self-Calibration °C ± 1 °C	Self-Calibration °C ± 5 °C
≤109 MHz	—	-40
	-60, typical	-50, typical
>109 MHz to 500 MHz	—	-40
	-50, typical	-45, typical
>500 MHz to 3 GHz	—	-65
	-75, typical	-70, typical
>3 GHz to 5 GHz	—	-55
	-70, typical	-60, typical

¹⁰ Conditions: VSA frequency range 109 MHz to 6 GHz. Measurement performed after self-calibration.

Table 8. VSA Residual Sideband Image, 80 MHz Bandwidth (dBc) (Continued)

Center Frequency	Self-Calibration °C ± 1 °C	Self-Calibration °C ± 5 °C
>5 GHz to 6 GHz	—	-60
	-70, typical	-65, typical

Conditions: Reference levels -30 dBm to +30 dBm.

This specification describes the maximum residual sideband image within an 80 MHz bandwidth at a given RF center frequency. Bandwidth is restricted to 20 MHz for LO frequencies ≤ 109 MHz.

This specification is valid only when the module is operating within the specified ambient temperature range and within the specified range from the last self-calibration temperature, as measured with the onboard temperature sensors.

For optimal performance, NI recommends running self-calibration when the PXIe-5645 temperature drifts ± 5 °C from the temperature at the last self-calibration. For temperature changes $>\pm 5$ °C from self-calibration, residual image suppression is -40 dBc.

Figure 6. VSA Residual Sideband Image,¹¹ 0 dBm Reference Level, Typical

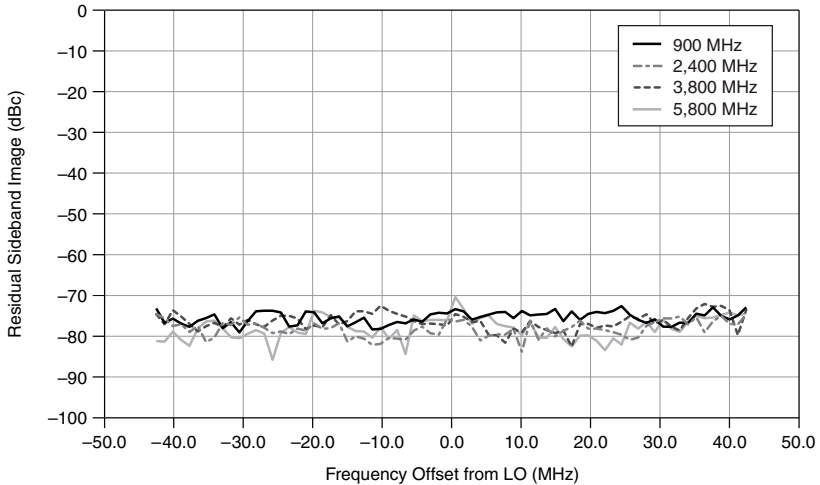

¹¹ Measurement performed after self-calibration.

Figure 7. VSA Residual Sideband Image,¹¹ -30 dBm Reference Level, Typical

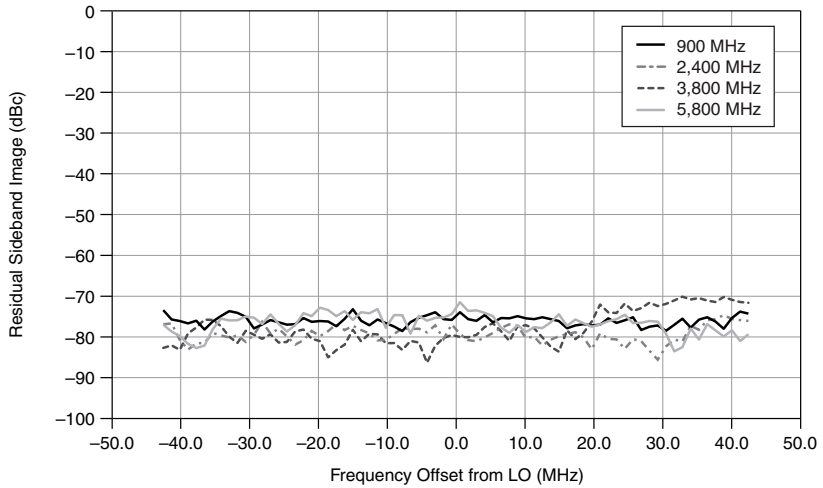

Third-Order Input Intermodulation

Table 9. Third-Order Input Intercept Point (IIP₃), -5 dBm Reference Level, Typical

Frequency Range	IIP ₃ (dBm)
65 MHz to 1.5 GHz	19
>1.5 GHz to 6 GHz	20

Conditions: Two -10 dBm tones, 700 kHz apart at RF IN; reference level: -5 dBm <4 GHz, -2 dBm reference level otherwise; nominal noise floor: -148 dBm/Hz for -5 dBm reference level, -145 dBm/Hz for -2 dBm reference level.

Table 10. Third-Order Input Intercept Point (IIP₃), -20 dBm Reference Level, Typical

Frequency Range	IIP ₃ (dBm)
65 MHz to 200 MHz	9
>200 MHz to 2 GHz	11
>2 GHz to 3.75 GHz	8
>3.75 GHz to 4.25 GHz	6
>4.25 GHz to 5 GHz	4

Table 10. Third-Order Input Intercept Point (IIP₃), -20 dBm Reference Level, Typical (Continued)

Frequency Range	IIP ₃ (dBm)
>5 GHz to 6 GHz	1
Conditions: Two -25 dBm tones, 700 kHz apart at RF IN; reference level: -20 dBm; nominal noise floor: -157 dBm/Hz.	

Second-Order Input Intermodulation

Table 11. Second-Order Input Intercept Point (IIP₂), -2 dBm Reference Level, Typical¹²

Frequency Range	IIP ₂ (dBm)
65 MHz to 1.5 GHz	67
>1.5 GHz to 4 GHz	58
>4 GHz to 6 GHz	52

RF Output

Power Range

Table 12. Power Range

Output Type	Frequency	Power Range	
CW	<4 GHz	Noise floor to +10 dBm, average power ¹³	Noise floor to +15 dBm, average power, nominal
	≥4 GHz	Noise floor to +7 dBm, average power ¹³	Noise floor to +12 dBm, average power, nominal

¹² Conditions: Two -10 dBm tones, 700 kHz apart at RF IN; reference level: -2 dBm; nominal noise floor: -145 dBm/Hz.

¹³ Higher output is uncalibrated and may be compressed.

Table 12. Power Range (Continued)

Output Type	Frequency	Power Range	
Modulated ¹⁴	<4 GHz	Noise floor to +6 dBm, average power	—
	≥4 GHz	Noise floor to +3 dBm, average power	—

Output attenuator resolution 2 dB, nominal

Digital attenuation resolution¹⁵ 0.1 dB or better

Related Information

Refer to the [Considering Average Power and Crest Factor topic of the NI RF Vector Signal Transceivers Help](#) for more information about modulated signal power.

Amplitude Settling Time

0.1 dB of final value¹⁶ 50 μs

0.5 dB of final value¹⁷, with LO retuned 300 μs

Output Power Level Accuracy

Table 13. Output Power Level Accuracy (dB)

Center Frequency	15 °C to 35 °C		0 °C to 55 °C	
	Self-Calibration °C ± 1 °C	Self-Calibration °C ± 5 °C	Self-Calibration °C ± 1 °C	Self-Calibration °C ± 5 °C
65 MHz to <109 MHz	—	±0.70	—	±0.90
	—	±0.55 (95th percentile, ≈ 2σ)	—	±0.65 (95th percentile, ≈ 2σ)
	±0.26, typical	±0.40, typical	±0.36, typical	±0.50, typical

¹⁴ Up to 12 dB crest factor, based on 3GPP LTE uplink requirements.

¹⁵ Average output power ≥ -100 dBm.

¹⁶ Constant LO frequency, varying RF output power range. Power levels ≤ 0 dBm. 175 μs for power levels > 0 dBm.

¹⁷ LO tuning across harmonic filter bands.

Table 13. Output Power Level Accuracy (dB) (Continued)

Center Frequency	15 °C to 35 °C		0 °C to 55 °C	
	Self-Calibration °C ± 1 °C	Self-Calibration °C ± 5 °C	Self-Calibration °C ± 1 °C	Self-Calibration °C ± 5 °C
109 MHz to <270 MHz ¹⁸	±0.26, typical	±0.75	±0.36, typical	±0.90
		±0.60 (95th percentile; ≈ 2σ)		±0.70 (95th percentile; ≈ 2σ)
		±0.45, typical		±0.55, typical
270 MHz to <375 MHz	—	±0.70	—	±0.90
	—	±0.55 (95th percentile, ≈ 2σ)	—	±0.65 (95th percentile, ≈ 2σ)
	±0.26, typical	±0.40, typical	±0.36, typical	±0.50, typical
375 MHz to <2 GHz	—	±0.75	—	±0.90
	—	±0.55 (95th percentile, ≈ 2σ)	—	±0.65 (95th percentile, ≈ 2σ)
	±0.26, typical	±0.40, typical	±0.36, typical	±0.50, typical
2 GHz to <4 GHz	—	±0.75	—	±0.90
	—	±0.60 (95th percentile, ≈ 2σ)	—	±0.70 (95th percentile, ≈ 2σ)
	±0.26, typical	±0.40, typical	±0.36, typical	±0.50, typical

¹⁸ Harmonic suppression is reduced in this frequency range. As a result, offset errors may occur depending on whether you are using a true RMS device, such as a power meter.

Table 13. Output Power Level Accuracy (dB) (Continued)

Center Frequency	15 °C to 35 °C		0 °C to 55 °C	
	Self-Calibration °C ± 1 °C	Self-Calibration °C ± 5 °C	Self-Calibration °C ± 1 °C	Self-Calibration °C ± 5 °C
4 GHz to 6 GHz	—	±1.00	—	±1.15
	—	±0.80 (95th percentile, $\approx 2\sigma$)	—	±0.90 (95th percentile, $\approx 2\sigma$)
	±0.28, typical	±0.40, typical	±0.38, typical	±0.60, typical

Conditions: CW average power -70 dBm to +10 dBm.

For power <-70 dBm, highly accurate generation can be achieved using digital attenuation, which relies on DAC linearity.

The absolute amplitude accuracy is measured at 3.75 MHz offset from the configured center frequency. The absolute amplitude accuracy measurements are made after the PXIe-5645 has settled.

This specification is valid only when the module is operating within the specified ambient temperature range and within the specified range from the last self-calibration temperature, as measured with the onboard temperature sensors.

Figure 8. Relative Power Accuracy, -40 dBm to 10 dBm, 10 dB Steps, Typical

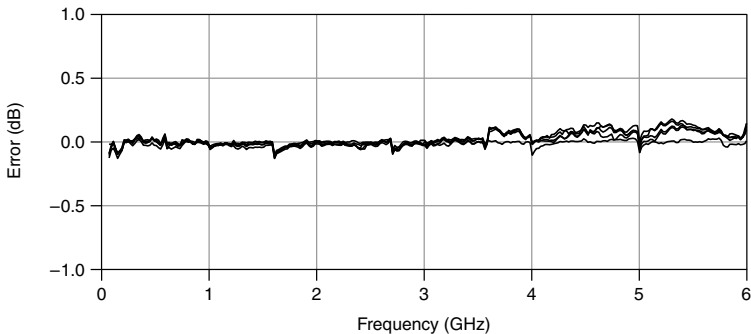

Frequency Response

Table 14. VSG Frequency Response (dB) (Amplitude, Equalized)

Output Frequency	Bandwidth	Self-Calibration °C ± 5 °C
≤109 MHz	20 MHz	±1.0, typical
>109 MHz to 375 MHz	20 MHz	±0.5
	40 MHz	±1.0, typical
>375 MHz to 6 GHz	80 MHz	±0.5

For this specification, frequency refers to the RF output frequency. This specification is valid only when the module is operating within the specified ambient temperature range and within the specified range from the last self-calibration temperature, as measured with the onboard temperature sensors.

Figure 9. VSG Measured Frequency Response¹⁹

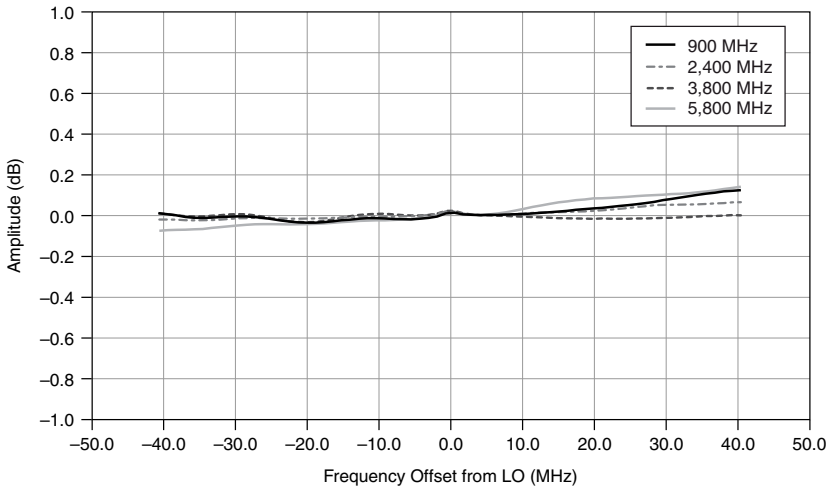

¹⁹ Conditions: Output -10 dBm CW tone. Measurement performed after self-calibration.

Output Noise Density

Table 15. Average Output Noise Level (dBm/Hz)

Center Frequency	Power Setting		
	-30 dBm	0 dBm	10 dBm
65 MHz to 500 MHz	—	—	-136
	-168, typical	-150, typical	-140, typical
>500 MHz to 2.5 GHz	-168, typical	-150	-141
>2.5 GHz to 3.5GHz	-168, typical	-149	-139
>3.5 GHz to 6 GHz	-165, typical	-147	-136

Conditions: Averages: 200 sweeps; baseband signal attenuation: -40 dB; noise measurement frequency offset: 4 MHz relative to output tone frequency.

Spurious Responses

Harmonics

Table 16. Second Harmonic Level (dBc)

Fundamental Frequency	23 °C ± 5 °C	0 °C to 55 °C
65 MHz to 3.5 GHz	-27	-24.8
	-29.5, typical	-27.2, typical
>3.5 GHz to 4.5 GHz	-26.3	-24
	-28.9, typical	-26.6, typical
>4.5 GHz to 6 GHz	-28.9	-26.6
	-33.3, typical	-31, typical

Conditions: Measured using 1 MHz baseband signal -1 dBFS; fundamental signal measured at +6 dBm CW; second harmonic levels nominally <-30 dBc for fundamental output levels of ≤5 dBm.



Note Higher order harmonic suppression is degraded in the range of 109 MHz to 270 MHz, and third harmonic performance is shown in the following figure. For frequencies outside the range of 109 MHz to 270 MHz, higher order harmonic

distortion is equal to or better than the second harmonic level as specified in the previous table.

Figure 10. Harmonic Level,²⁰ 65 MHz to 500 MHz, Measured

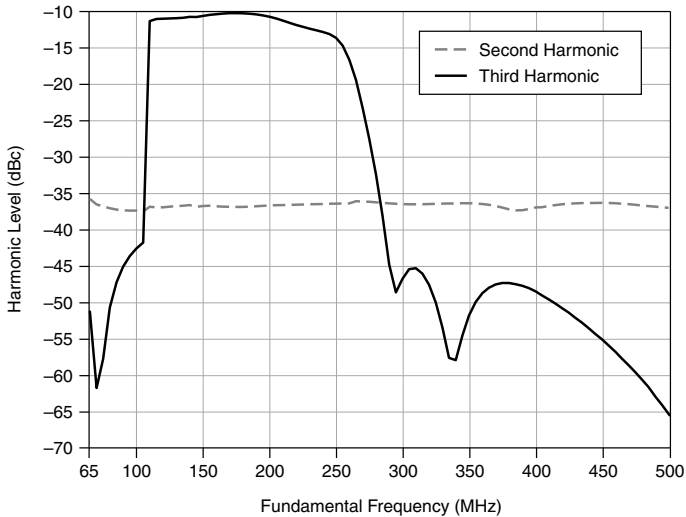

Nonharmonic Spurs

Table 17. Nonharmonic Spurs (dBc)

Frequency	<100 kHz Offset	≥100 kHz Offset	>1 MHz Offset
65 MHz to 3 GHz	<-55, typical	<-62	<-75
>3 GHz to 6 GHz	<-55, typical	<-57	<-70

Conditions: Output full scale level ≥-30 dBm. Measured with a single tone at -1 dBFS.

Third-Order Output Intermodulation

Table 18. Third-Order Output Intermodulation Distortion (IMD₃) (dBc), 0 dBm Tones

Fundamental Frequency	Baseband DAC: -2 dBFS	Baseband DAC: -6 dBFS
65 MHz to 1 GHz	-55, typical	-60, typical
>1 GHz to 3 GHz	-53, typical	-53, typical

²⁰ Measured using 1 MHz baseband signal -1 dBFS; fundamental signal measured at +6 dBm CW.

Table 18. Third-Order Output Intermodulation Distortion (IMD₃) (dBc), 0 dBm Tones (Continued)

Fundamental Frequency	Baseband DAC: -2 dBFS	Baseband DAC: -6 dBFS
>3 GHz to 5 GHz	-49, typical	-50, typical
>5 GHz to 6 GHz	-44, typical	-45, typical
Conditions: Two 0 dBm tones, 500 kHz apart at RF OUT. RF gain applied to achieve the desired output power per tone.		

Table 19. Third-Order Output Intermodulation Distortion (IMD₃) (dBc), -6 dBm Tones

Fundamental Frequency	Baseband DAC: -2 dBFS	Baseband DAC: -6 dBFS
65 MHz to 1.5 GHz	-50	-59
	-54, typical	-62, typical
>1.5 GHz to 3.5 GHz	-54	-59
	-57, typical	-62, typical
>3.5 GHz to 5 GHz	-50	-55
	-53, typical	-58, typical
>5 GHz to 6 GHz	-47	-51
	-50, typical	-54, typical
Conditions: Two -6 dBm tones, 500 kHz apart at RF OUT. RF gain applied to achieve the desired output power per tone.		

Table 20. Third-Order Output Intermodulation Distortion (IMD₃) (dBc), -36 dBm Tones

Fundamental Frequency	Baseband DAC: -2 dBFS	Baseband DAC: -6 dBFS
65 MHz to 200 MHz	-52	-57
	-54, typical	-60, typical

Table 20. Third-Order Output Intermodulation Distortion (IMD₃) (dBc), -36 dBm Tones (Continued)

Fundamental Frequency	Baseband DAC: -2 dBFS	Baseband DAC: -6 dBFS
>200 MHz to 6 GHz	-52	-55
	-54, typical	-58, typical
Conditions: Two -36 dBm tones, 500 kHz apart at RF OUT. RF gain applied to achieve the desired output power per tone.		

LO Residual Power

Table 21. VSG LO Residual Power (dBc)

Center Frequency	Self-Calibration °C ± 1 °C	Self-Calibration °C ± 5 °C
≤109 MHz	—	-50
	-57, typical	-55, typical
>109 MHz to 375 MHz	—	-42
	-47, typical	-45, typical
>375 MHz to 1.6 GHz	—	-55
	-62, typical	-60, typical
1.6 GHz to 2 GHz	—	-54
	-60, typical	-58, typical
2 GHz to 3 GHz	—	-47
	-53, typical	-51, typical
3 GHz to 4 GHz	—	-52
	-57, typical	-55, typical
4 GHz to 5 GHz	—	-51
	-60, typical	-56, typical

Table 21. VSG LO Residual Power (dBc) (Continued)

Center Frequency	Self-Calibration °C ± 1 °C	Self-Calibration °C ± 5 °C
5 GHz to 6 GHz	—	-47
	-56, typical	-52, typical

Conditions: Configured power levels -50 dBm to +10 dBm.

This specification is valid only when the module is operating within the specified ambient temperature range and within the specified range from the last self-calibration temperature, as measured with the onboard temperature sensors.

For optimal performance, NI recommends running self-calibration when the PXIe-5645 temperature drifts ± 5 °C from the temperature at the last self-calibration. For temperature changes >± 5 °C from self-calibration, LO residual power is -40 dBc.

Figure 11. VSG LO Residual Power,²¹ 109 MHz to 6 GHz, Typical

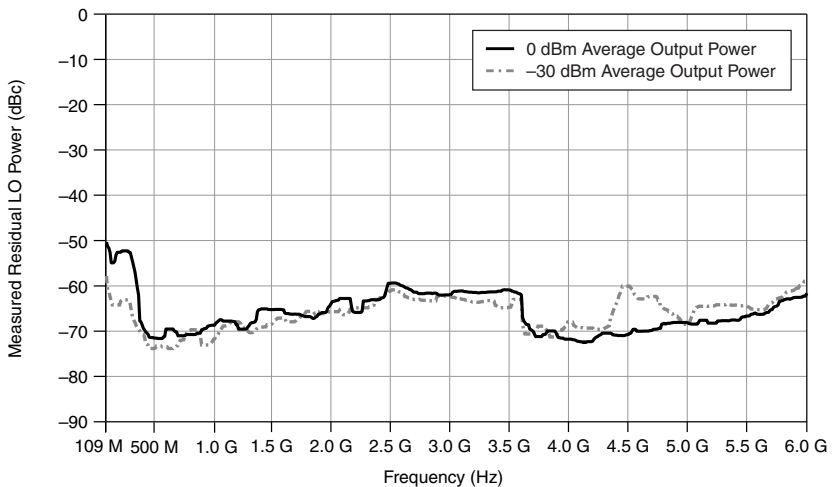

Table 22. VSG LO Residual Power (dBc), Low Power

Center Frequency	Self-Calibration °C ± 5 °C
≤109 MHz	—
	-49, typical

²¹ Measurement performed after self-calibration.

Table 22. VSG LO Residual Power (dBc), Low Power (Continued)

Center Frequency	Self-Calibration °C ± 5 °C	
>109 MHz to 375 MHz	-45	
	-50, typical	
>375 MHz to 2 GHz	-55	
	-60, typical	
>2 GHz to 3 GHz	-50	
	-53, typical	
>3 GHz to 4 GHz	-55	
	-58, typical	
>4 GHz to 5 GHz	—	
	-40, typical	
>5 GHz to 6 GHz	-43	
	-45, typical	

Conditions: Configured power levels < -50 dBm to -70 dBm.

This specification is valid only when the module is operating within the specified ambient temperature range and within the specified range from the last self-calibration temperature, as measured with the onboard temperature sensors.

For optimal performance, NI recommends running self-calibration when the PXIe-5645 temperature drifts ± 5 °C from the temperature at the last self-calibration. For temperature changes >± 5 °C from self-calibration, LO residual power is -40 dBc.

Residual Sideband Image

Table 23. VSG Residual Sideband Image (dBc), 80 MHz Bandwidth

Center Frequency	Self-Calibration °C ± 1 °C	Self-Calibration °C ± 5 °C
≤109 MHz	—	-40
	-55, typical	-45, typical
>109 MHz to 375 MHz	—	—
	-45, typical	-40, typical

Table 23. VSG Residual Sideband Image (dBc), 80 MHz Bandwidth (Continued)

Center Frequency	Self-Calibration °C ± 1 °C	Self-Calibration °C ± 5 °C
>375 MHz to 2 GHz	—	-60
	-70, typical	-65, typical
>2 GHz to 4 GHz	—	-50
	-65, typical	-55, typical
>4 GHz to 6 GHz	—	-40
	-70, typical	-50, typical

Conditions: Configured power levels -50 dBm to +10 dBm.

This specification describes the maximum residual sideband image within an 80 MHz bandwidth at a given RF center frequency. Bandwidth is restricted to 20 MHz for LO frequencies \leq 109 MHz.

This specification is valid only when the module is operating within the specified ambient temperature range and within the specified range from the last self-calibration temperature, as measured with the onboard temperature sensors.

For optimal performance, NI recommends running self-calibration when the PXIe-5645 temperature drifts \pm 5 °C from the temperature at the last self-calibration. For temperature changes \geq 5 °C from self-calibration, residual image suppression is -40 dBc.

Figure 12. VSG Residual Sideband Image,²² 0 dBm Average Output Power, Typical

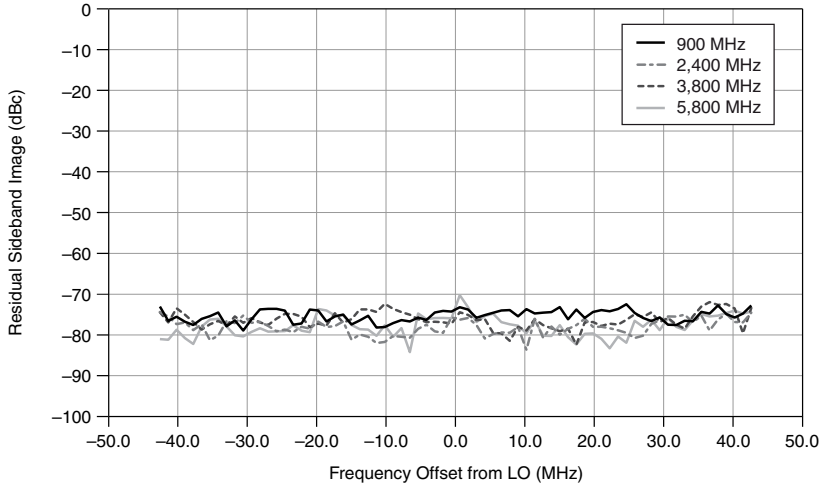
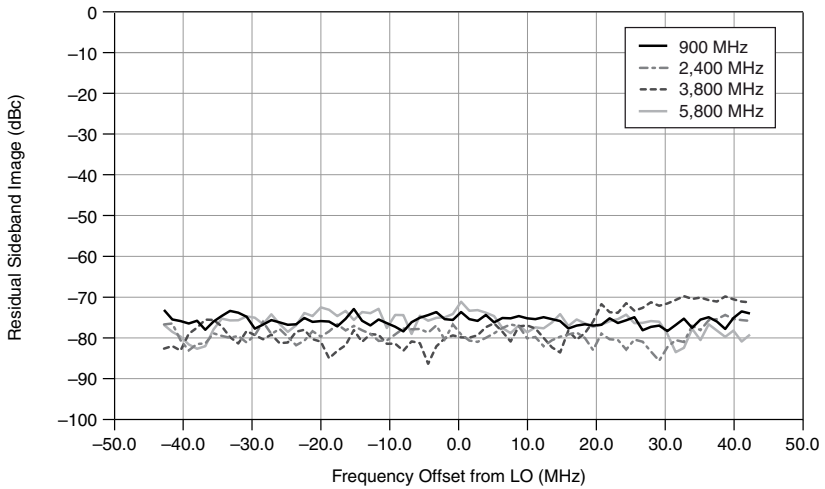

Figure 13. VSG Residual Sideband Image,²² -30 dBm Average Output Power, Typical



²² Measurement performed after self-calibration.

Error Vector Magnitude (EVM)

VSA EVM

20 MHz bandwidth 64-QAM EVM²³ -40 dB, typical
375 MHz to 6 GHz

Figure 14. VSA Error Vector Magnitude, Typical²⁴

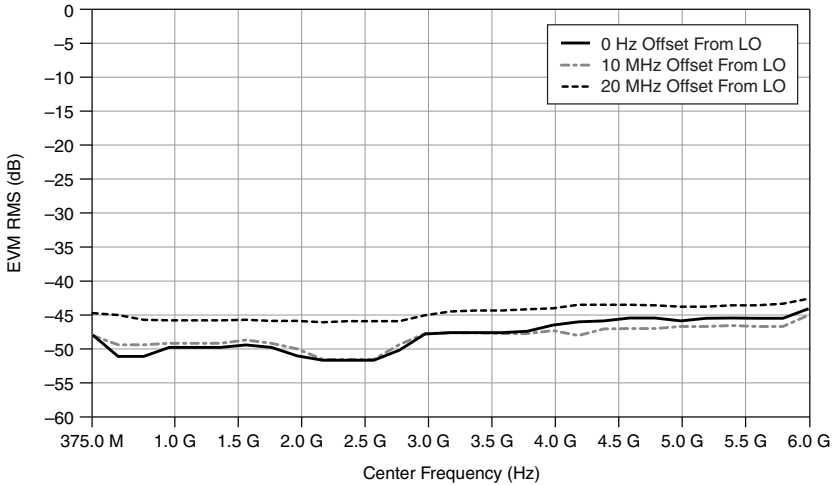

VSG EVM

20 MHz bandwidth 64-QAM EVM²⁵ -40 dB, typical
375 MHz to 6 GHz

- ²³ Conditions: EVM signal: 20 MHz bandwidth; 64 QAM signal. Pulse-shape filtering: root-raised-cosine, alpha=0.25; PXIe-5645 reference level: -10 dBm; Reference Clock source: internal; record length: 300 μ s. Generator: PXIe-5673; power (average): -14 dBm; Reference Clock source: internal.
- ²⁴ Conditions: 20 MHz bandwidth, 64 QAM; centered at LO frequency or offset digitally as listed.
- ²⁵ Conditions: EVM signal: 20 MHz bandwidth; 64 QAM signal. Pulse-shape filtering: root-raised cosine, alpha=0.25; PXIe-5645 peak output power: -10 dBm; Reference Clock source: internal. Measurement instrument: PXIe-5665; reference level: -10 dBm; Reference Clock source: internal; record length: 300 μ s.

Figure 15. RMS EVM (dB) versus Measured Average Power (dBm), Typical ²⁶

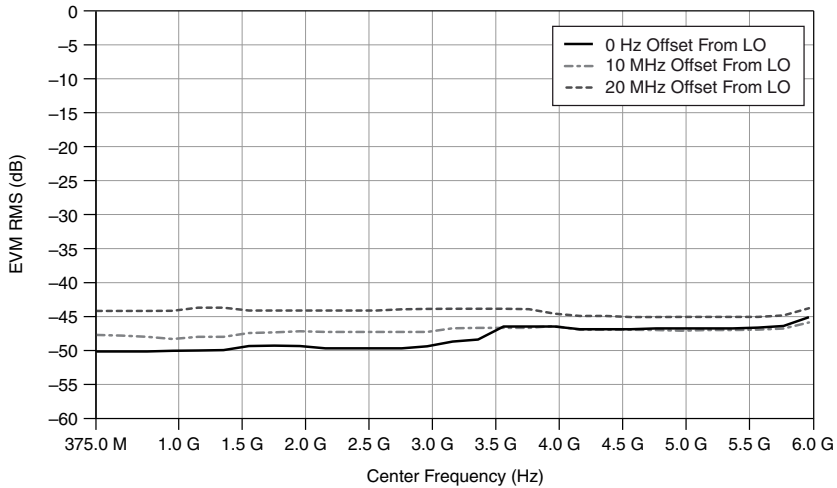

I/Q Interface

Differential and Single-Ended Operation

The I/Q inputs and outputs of the PXIe-5645 support both single-ended and differential operation. This section explains some of the fundamental analog signal processing that occurs in the first stages of the I/Q receiver.

A differential signal system has a positive component ($V_{\text{INPUT}}(\text{CH}+)$) and a negative component ($V_{\text{INPUT}}(\text{CH}-)$). The differential signal can have a common-mode offset ($V_{\text{IN_COM}}$) shared by both $V_{\text{INPUT}}(\text{CH}+)$ and $V_{\text{INPUT}}(\text{CH}-)$. The differential input signal is superimposed on the common-mode offset. The input circuitry rejects the input common-mode offset signal.

In a differential system, any noise present on both $V_{\text{INPUT}}(\text{CH}+)$ and $V_{\text{INPUT}}(\text{CH}-)$ gets rejected. Differential systems also double the dynamic range compared to a single-ended system with the same voltage swing. The following figure illustrates the key concepts of differential offset and common-mode offset associated with a differential system.

²⁶ Conditions: 20 MHz bandwidth, 64 QAM; centered at LO frequency or offset digitally as listed.

Figure 16. Definition of Common-Mode Offset and Differential Offset

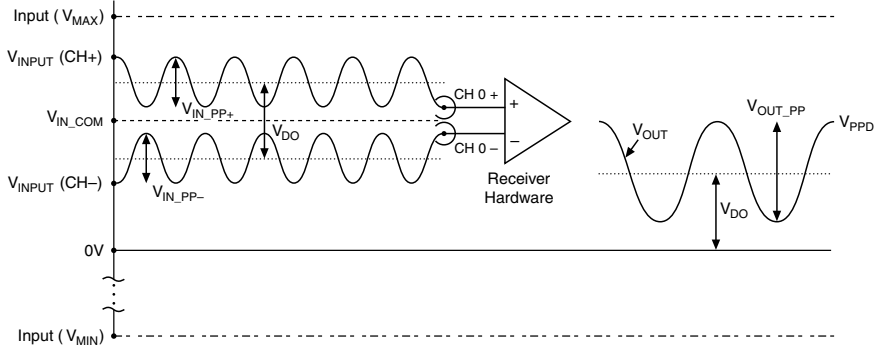

where

V_{IN_PP+} represents the peak-to-peak amplitude of the positive AC input signal

V_{IN_PP-} represents the peak-to-peak amplitude of the negative AC input signal

V_{DO} represents the differential offset voltage

V_{IN_COM} represents the common-mode offset voltage

V_{OUT_PP} represents the peak-to-peak amplitude of the output signal

In the previous figure, the input common-mode voltage is not present after the first stage of the receiver system. The signal remaining at the output of the receiver circuitry is the signal of interest.



Note The differential signal can have an offset between V_{IN_PP+} and V_{IN_PP-} . This is known as the *differential offset* and is retained by the receiver circuitry.

In an I/Q analyzer, a differential offset can occur because of LO leakage or harmonics. In the case of I/Q generation, a differential offset can cause spurs and magnitude error.

In a phase-balanced differential system, the peak-to-peak amplitude of the positive AC input signal (V_{IN_PP+}) is equal to the peak-to-peak amplitude of the negative AC input signal (V_{IN_PP-}). The AC peak-to-peak amplitude of the output signal is the sum of V_{IN_PP+} and V_{IN_PP-} . A more general definition for the output voltage regardless of phase is the difference between V_{IN_PP+} and V_{IN_PP-} , described by the following equation:

$$V_{OUT} = (V_{IN_PP+}) - (V_{IN_PP-})$$

The common-mode offset, which represents the rejected component common to both signals, is described by the following equation:

$$V_{IN_COM} = [(V_{IN_PP+}) + (V_{IN_PP-})]/2$$

Related Information

[Refer to the NI RF Vector Signal Transceivers Help for more information about differential and single-ended operation on the NI 5645R.](#)

I/Q Input

Vertical Range

Maximum input voltage	
Maximum functional voltage	± 2.5 V, typical
Maximum input voltage ²⁷ (damage)	± 3 V
Common-mode range ²⁸	± 2 V
Differential voltage range	
Analog	$0.032 V_{pk-pk}$ to $2 V_{pk-pk}$
Digital	$<0.032 V_{pk-pk}$
Single-ended voltage range ²⁹	
Analog	$0.032 V_{pk-pk}$ to $2 V_{pk-pk}$
Digital	$<0.032 V_{pk-pk}$
Analog gain step range	36 dB
Gain step resolution	1 dB, typical

Absolute DC Gain Accuracy

Table 24. I/Q Input Absolute DC Gain Error

Temperature Range	Absolute Gain Error
Within ± 5 °C of 23 °C	$\pm 1.75\%$
	$\pm 1.10\%$, typical

²⁷ Common-mode voltage plus peak AC voltage cannot exceed the maximum input voltage of 2.5 V.

²⁸ Common-mode voltage plus peak AC voltage cannot exceed the maximum input voltage of 2.5 V. Valid for all differential levels.

²⁹ To use the I or Q channel in single-ended terminal configuration, connect the positive (+) terminal to the active signal and terminate the negative (-) terminal with a 50 Ω termination.

Table 24. I/Q Input Absolute DC Gain Error (Continued)

Temperature Range	Absolute Gain Error
Outside ± 5 °C of 23°C	-0.033%/°C
	-0.027%/°C, typical
<p>The accuracy of a measured DC signal using the 0.5 V differential input range is calculated using the following equations:</p> <p>Gain accuracy for temperature within ± 5 °C of ambient 23 °C: $\pm(1.75\% \times 0.5 \text{ V}) = \pm 8.75 \text{ mV}$</p> <p>Gain accuracy for a temperature at +20 °C above ambient 23 °C: $\pm 8.75 \text{ mV} - 0.033\% \times 15 \text{ °C} \times (0.5) = +6.28 \text{ mV} / -11.23 \text{ mV}$</p>	

Table 25. I/Q Input DC Offset Error (mV)

Temperature Range	I/Q Input DC Offset Error
23 °C \pm 5 °C	± 15
	± 6 , typical
0 °C to 55 °C	± 20
	± 10 , typical

Absolute AC Gain Accuracy

Table 26. I/Q Input Absolute AC Gain Accuracy³⁰ (dB)

Input Range	23 °C \pm 5 °C	0 °C to 55 °C
2 V _{pk-pk}	0.42	0.47
	0.1, typical	0.16, typical
0.5 V _{pk-pk}	0.41	0.47
	0.1, typical	0.16, typical
0.1 V _{pk-pk}	0.52	0.60
	0.1, typical	0.23, typical

³⁰ Configured for 0 V common-mode, differential. Measured CW at 500 kHz.

Complex Equalized Bandwidth

Complex I/Q equalized bandwidth³¹ 80 MHz

Bandwidth (equalization enabled or disabled)

Baseband 40 MHz

Complex baseband 80 MHz when used with an external I/Q modulator



Note To operate the device in complex baseband mode, configure each channel with identical ranges and termination. Complex baseband mode requires two input signals that are 90° out of phase.

Passband Flatness

Table 27. I/Q Input Passband Flatness³² (dB)

I or Q Bandwidth	23 °C ± 5 °C	0 °C to 55 °C
20 MHz	0.43	0.49
	0.15, typical	0.21, typical
40 MHz	0.52	0.58
	0.21, typical	0.27, typical

³¹ Complex equalized bandwidth is the combined bandwidth of I and Q channels. Valid only when using identical gain and termination settings for each I/Q channel.

³² Referenced to 500 kHz. Digital equalization enabled. Valid only when using identical gain and termination settings for each I/Q channel.

Figure 17. I/Q Input Passband Flatness³²

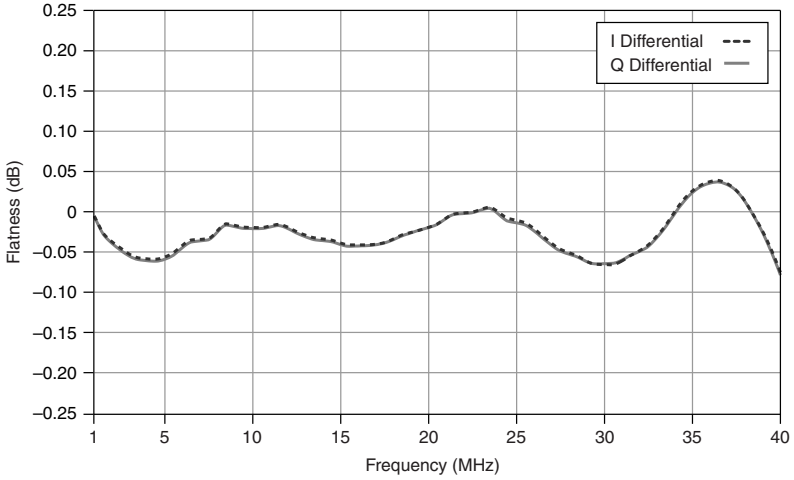

Channel-to-Channel Gain Imbalance

Table 28. I/Q Input Gain Imbalance³³ (dB)

Complex Bandwidth	23 °C ± 5 °C	0 °C to 55 °C
40 MHz	± 0.025	± 0.06
	± 0.02, typical	± 0.04, typical
80 MHz	± 0.045	± 0.075
	± 0.03, typical	± 0.05, typical

Channel-to-Channel Phase Matching

Table 29. I/Q Input Phase Matching³⁴ (Degrees)

Complex Bandwidth	23 °C ± 5 °C	0 °C to 55 °C
40 MHz	± 0.10	± 0.3
	± 0.06, typical	± 0.16, typical

³³ Digital equalization enabled. Valid only when using identical gain and termination settings for each I/Q channel.

³⁴ Digital equalization enabled. Valid only when using identical gain and termination settings for each I/Q channel.

Table 29. I/Q Input Phase Matching³⁴ (Degrees) (Continued)

Complex Bandwidth	23 °C ± 5 °C	0 °C to 55 °C
80 MHz	± 0.16	± 0.5
	± 0.10, typical	± 0.35, typical

Image Suppression

Table 30. I/Q Input Image Suppression³⁵ (dBc)

Complex Bandwidth	23 °C ± 5 °C
40 MHz	-60
	-63, typical
80 MHz	-57
	-60, typical

Image suppression is equivalent or better than specification at all frequency offsets within the specified bandwidth.

For ambient temperatures from 0 °C to 55 °C, image suppression is -50 dBc, typical over 80 MHz of complex bandwidth. External calibration is recommended to optimize performance for a specific ambient temperature outside of 23 °C ± 5 °C.

³⁴ Digital equalization enabled. Valid only when using identical gain and termination settings for each I/Q channel.

³⁵ Digital equalization enabled. Valid only when using identical gain and termination settings for each I/Q channel.

Figure 18. I/Q Input Image Suppression,³⁶ Nominal

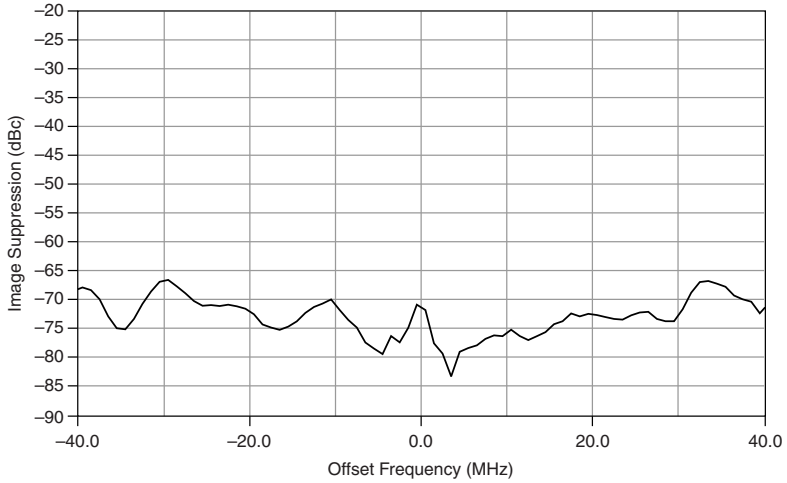

Spectral Characteristics

Spurious Free Dynamic Range (SFDR)

Figure 19. Measured I/Q Input SFDR³⁷

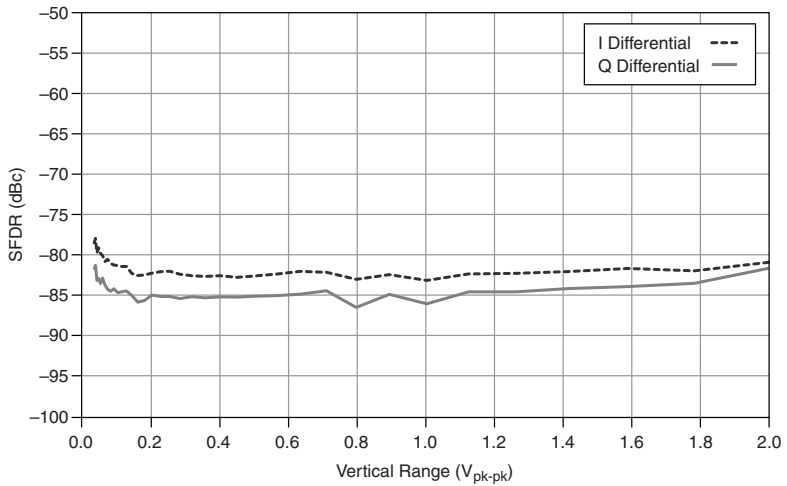

³⁶ Measured at 23 °C. Valid only when using identical gain and termination settings for each I/Q channel.

³⁷ Measured with a -1 dBFS tone at 9.9 MHz.

Signal to Noise and Distortion (SINAD)

I/Q input SINAD³⁸ (dB)

23 °C ± 5 °C

69, typical

0 °C to 55 °C

67, typical

Figure 20. Measured I/Q Input SINAD³⁸

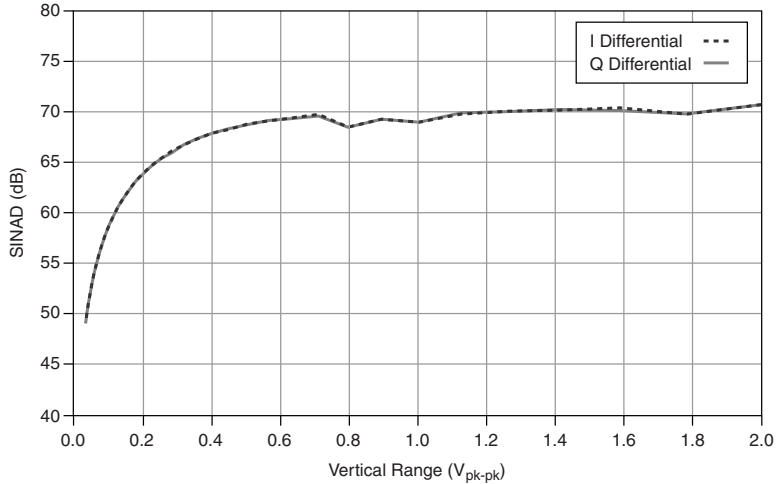

Signal-to-Noise Ratio (SNR)

I/Q input SNR³⁹ (dB)

23 °C ± 5 °C

69, typical

0 °C to 55 °C

67, typical

³⁸ Measured with a fixed -1 dBFS input signal at 9.9 MHz. Specification is valid within 20 MHz of bandwidth for I or Q.

³⁹ Measured with a -1 dBFS input signal at 9.9 MHz. Specification is valid within 20 MHz of bandwidth for I or Q.

Figure 21. I/Q Input SNR³⁹

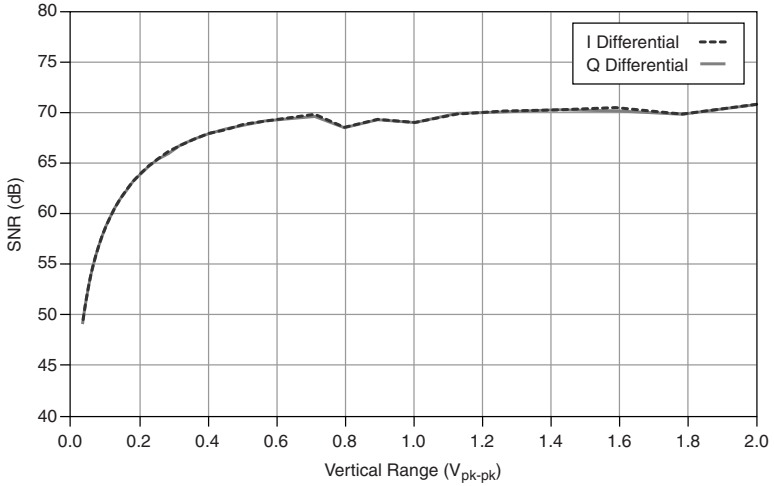

Average Noise Density

I/Q input average noise density⁴⁰ (dBm/Hz)

23 °C ± 5 °C	-147, typical
0 °C to 55 °C	-146, typical

Figure 22. Measured I/Q Input Noise Density⁴⁰

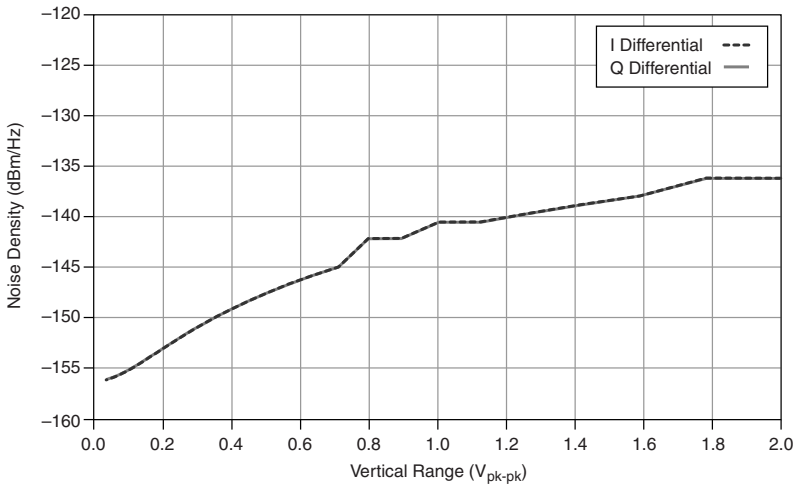

⁴⁰ Measured in the presence of a -40 dBFS signal.

Harmonics

I/Q input second harmonic⁴¹ (dBc)

23 °C ± 5 °C

-76, typical

0 °C to 55 °C

-75, typical

Figure 23. Measured I/Q Input Second Harmonic⁴¹

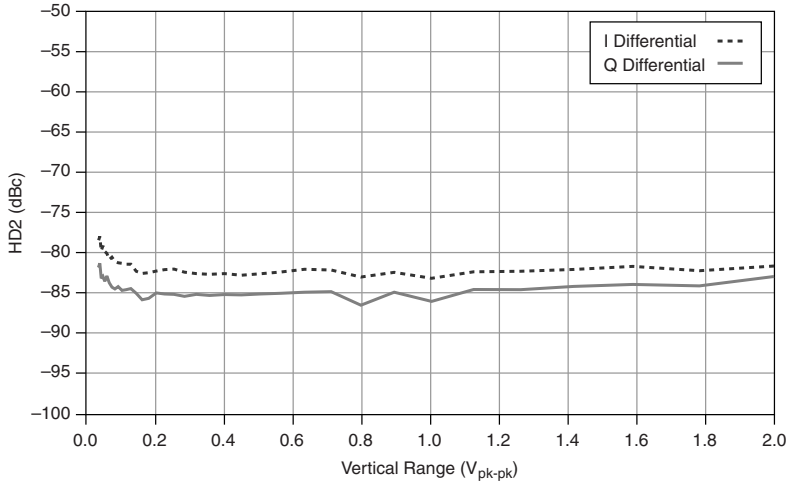

I/Q input third harmonic⁴¹ (dBc)

23 °C ± 5 °C

-80, typical

0 °C to 55 °C

-79, typical

⁴¹ Measured with a -1 dBFS input signal at 9.9 MHz.

Figure 24. Measured I/Q Input Third Harmonic⁴¹

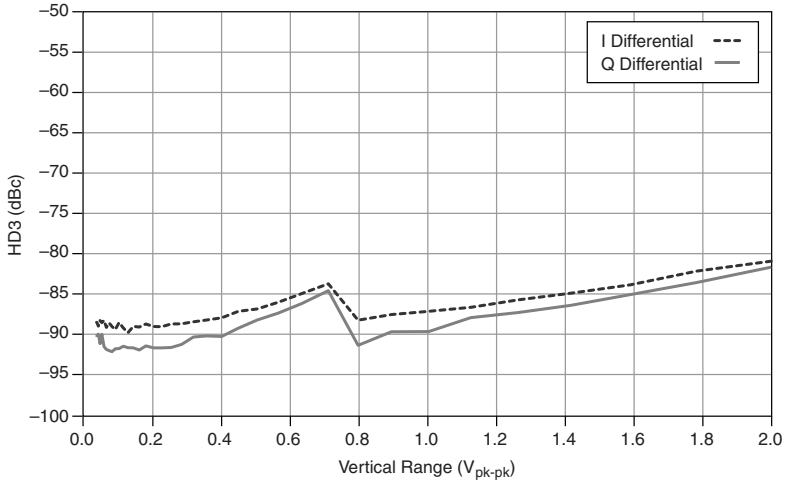
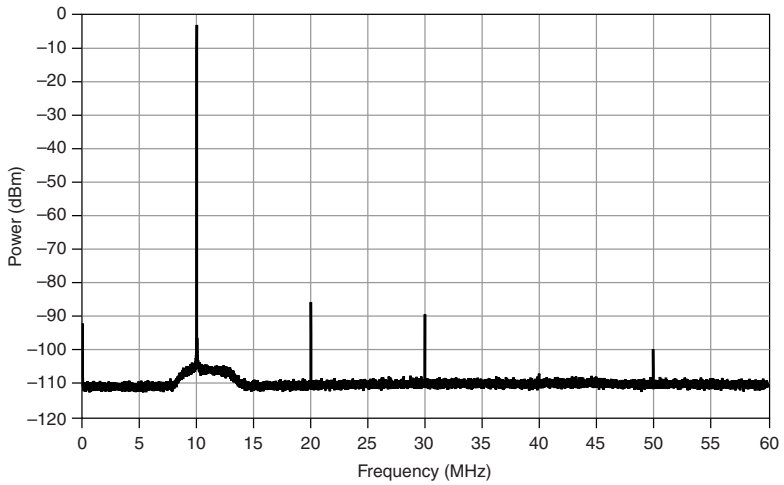

Figure 25. Measured I/Q Input Single Tone⁴²



⁴² Measured with 10 MHz bandpass filter to remove stimulus-related noise and distortion.

Third-Order Input Intermodulation

I/Q third-order input intermodulation⁴³ (IMD₃) (dBc)

23 °C ± 5 °C

-80, typical

0 °C to 55 °C

-79, typical

Figure 26. Measured I/Q Input IMD₃⁴³

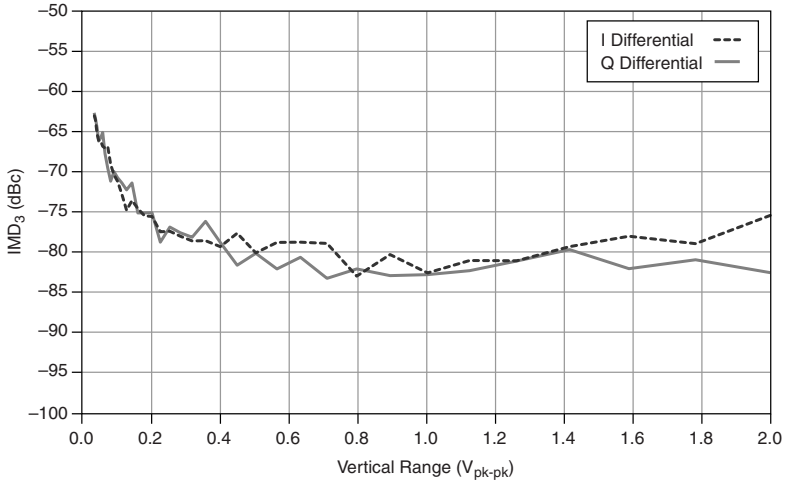
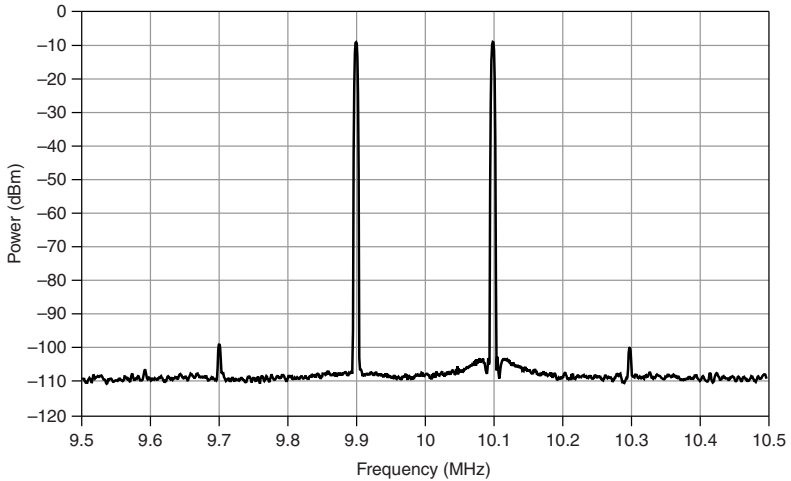

Figure 27. Measured I/Q Input Two-Tone Spectrum



⁴³ Measured with two-tone stimulus; each tone is -7 dBFS with a 200 kHz spacing; 9.9 MHz and 10.1 MHz tone frequencies.

Second-Order Input Intermodulation

I/Q second-order input intermodulation⁴⁴ (IMD₂) (dBc)

23 °C ± 5 °C	-77, typical
0 °C to 55 °C	-75, typical

Figure 28. Measured I/Q Input IMD₂⁴⁴

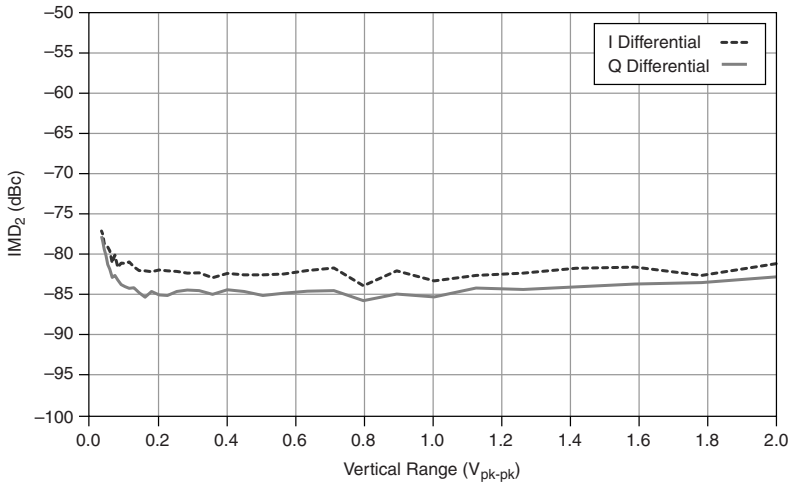

I/Q Output

Output Range⁴⁵

Maximum output voltage ±2.5 V

Common-mode range⁴⁶ ±2 V

Differential voltage range

Analogue	0.032V _{pk-pk} to 2 V _{pk-pk}
Digital	< 0.032 V _{pk-pk}

⁴⁴ Measured with two-tone stimulus; each tone is -7 dBFS with a 200 kHz spacing; 9.9 MHz and 10.1 MHz tone frequencies.

⁴⁵ High-impedance load.

⁴⁶ Valid for all differential levels.

Single-ended voltage range⁴⁷

Analog	0.016 V _{pk-pk} to 1 V _{pk-pk}
Digital	< 0.016 V _{pk-pk}
Analog gain step range	36 dB
Gain step resolution	1 dB, typical

Absolute DC Gain Accuracy

Table 31. I/Q Output Absolute DC Gain Error⁴⁸

Temperature Range	Absolute Gain Error
Within ±5 °C of 23 °C	±1.12%
	±0.62%, typical
Outside ±5 °C of 23°C	-0.055%/°C
	-0.045%/°C, typical
<p>The accuracy of a measured DC signal using the 0.5 V differential output range is calculated using the following equations:</p> <p>Gain accuracy for temperature within ±5 °C of ambient 23 °C: $\pm(1.12\% \times 0.5 \text{ V}) = \pm 5.6 \text{ mV}$</p> <p>Gain accuracy for a temperature at +20 °C above ambient 23 °C: $\pm 5.6 \text{ mV} - 0.055\% \times 15 \text{ }^\circ\text{C} \times (0.5) = +1.5 \text{ mV}/-9.8 \text{ mV}$</p>	

Table 32. I/Q Output DC Offset Error⁴⁹ (mV)

Temperature Range	I/Q Output DC Offset Error
23 °C ± 5 °C	±3.6
	±2.5, typical
0 °C to 55 °C	±4.5
	±2.9, typical

⁴⁷ To use the I or Q channel in single-ended terminal configuration, connect the positive (+) terminal to the active signal and terminate the negative (-) terminal with a 50 Ω termination.

⁴⁸ Measured with a DMM. Measured with both output terminals terminated to ground through a high impedance.

⁴⁹ High-impedance load.

Absolute AC Gain Accuracy

Table 33. I/Q Output Absolute AC Gain Accuracy⁵⁰ (dB)

Output Range	23 °C ± 5 °C	0 °C to 55 °C
1.0 V _{pk-pk}	0.48	0.53
	0.13, typical	0.19, typical
0.5 V _{pk-pk}	0.47	0.52
	0.13, typical	0.19, typical
0.1 V _{pk-pk}	0.57	0.64
	0.15, typical	0.22, typical

Complex Equalized Bandwidth

Complex I/Q equalized bandwidth⁵¹ 80 MHz

Bandwidth (equalization enabled)

Baseband 40 MHz

Complex baseband 80 MHz when used with an external I/Q modulator



Note To operate the device in complex baseband mode, configure each channel with identical ranges and termination. Complex baseband mode requires two input signals that are 90° out of phase.

Passband Flatness

Table 34. I/Q Output Passband Flatness⁵² (dB)

I or Q Bandwidth	23 °C ± 5 °C	0 °C to 55 °C
20 MHz	0.42	0.48
	0.13, typical	0.19, typical
40 MHz	0.43	0.49
	0.14, typical	0.20, typical

⁵⁰ Configured for 0 V common-mode, differential. Measured CW at 500 kHz.

⁵¹ Complex equalized bandwidth is the combined bandwidth of I and Q channels. Valid only when using identical gain and termination settings for each I/Q channel.

⁵² Referenced to 500 kHz. Valid only when using identical gain and termination settings for each I/Q channel.

Figure 29. I/Q Output Passband Flatness⁵²

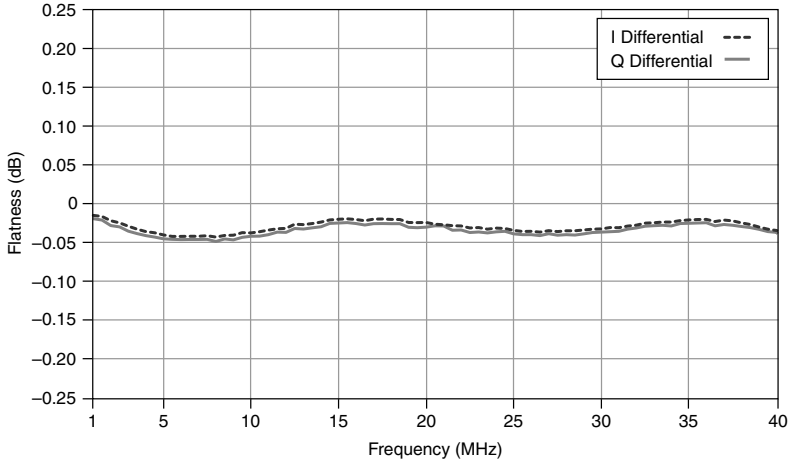

Channel-to-Channel Gain Imbalance

Table 35. I/Q Output Gain Imbalance⁵³ (dB)

Complex Bandwidth	23 °C ± 5 °C	0 °C to 55 °C
40 MHz	0.02	0.06
	0.015, typical	0.04, typical
80 MHz	0.025	0.065
	0.02, typical	0.045, typical

Channel-to-Channel Phase Matching

Table 36. I/Q Output Phase Matching⁵⁴ (Degrees)

Complex Bandwidth	23 °C ± 5 °C	0 °C to 55 °C
40 MHz	0.1	0.15
	0.05, typical	0.1, typical
80 MHz	0.125	0.15
	0.08, typical	0.1, typical

⁵³ Valid only when using identical gain and termination settings for each I/Q channel.

⁵⁴ Valid only when using identical gain and termination settings for each I/Q channel.

Image Suppression

Table 37. I/Q Output Image Suppression⁵⁵ (dBc)

Complex Bandwidth	23 °C ± 5 °C
40 MHz	-62
	-65, typical
80 MHz	-55
	-60, typical

Image suppression is equivalent or better than specification at all frequency offsets within the specified bandwidth.

For ambient temperatures from 0 °C to 55 °C, image suppression is -50 dBc, typical over 80 MHz of complex bandwidth. External calibration is recommended to optimize performance for a specific ambient temperature outside of 23 °C ± 5 °C.

Figure 30. I/Q Output Image Suppression, Nominal

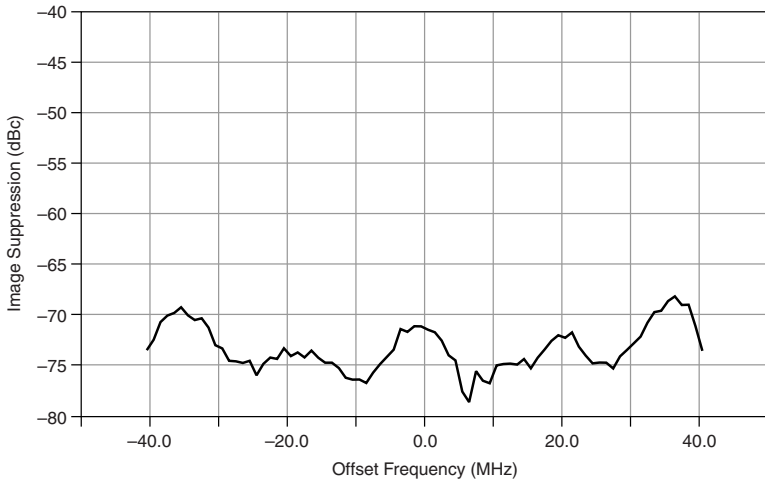

⁵⁵ Digital equalization enabled. Valid only when using identical gain and termination settings for each I/Q channel.

Spectral Characteristics

SFDR

Figure 31. Measured I/Q Output SFDR, 9.9 MHz Signal

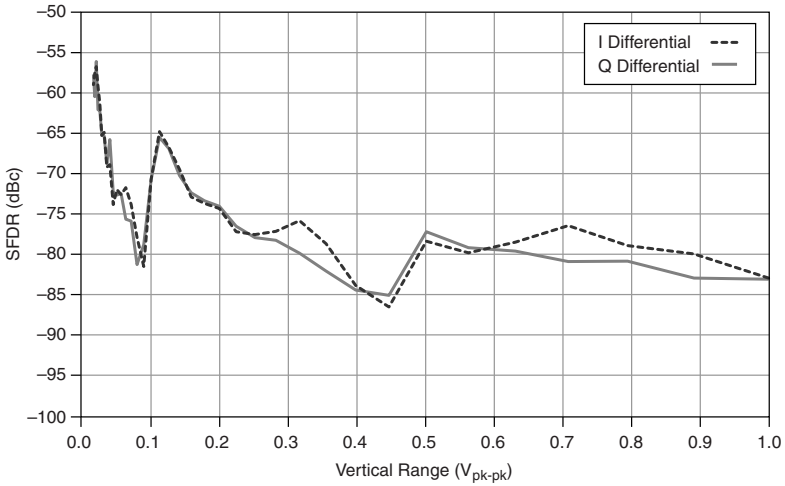

SINAD

I/Q output SINAD⁵⁶ (dB)

23 °C ± 5 °C

66, typical

0 °C to 55 °C

64, typical

⁵⁶ Generated -1 dBFS CW at 9.9 MHz. Includes harmonic and nonharmonic content. Short pattern waveforms may degrade the distortion performance by 3 dB.

Figure 32. Measured I/Q Output SINAD⁵⁶

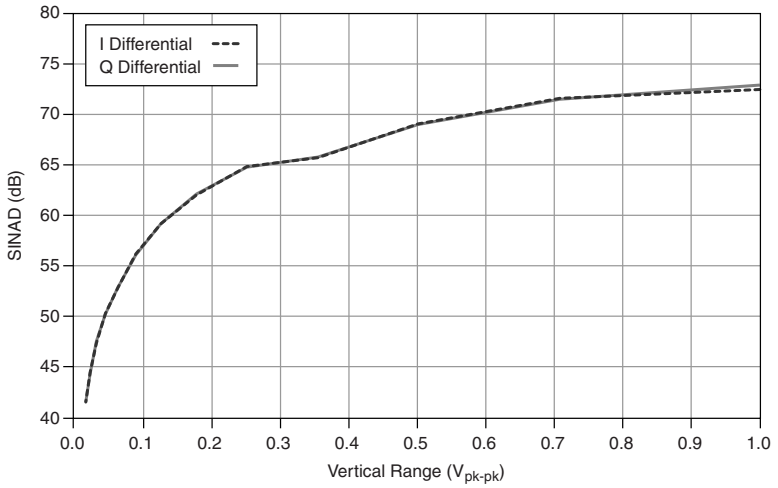

SNR

I/Q output SNR⁵⁷ (dB)

23 °C ± 5 °C

66, typical

0 °C to 55 °C

64, typical

⁵⁷ Generated -1 dBFS CW at 9.9 MHz.

Figure 33. Measured I/Q Output SNR⁵⁷

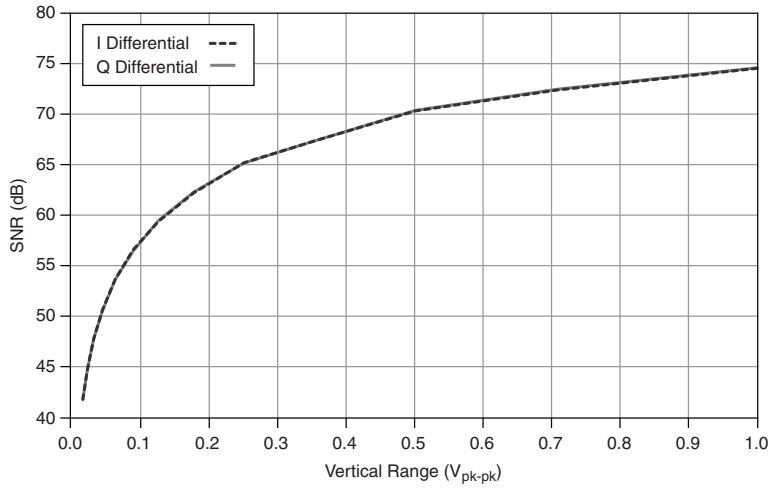

Average Noise Density

I/Q output average noise density⁵⁸ (dBm/Hz)

23 °C ± 5 °C

-149, typical

0 °C to 55 °C

-147, typical

⁵⁸ Terminated into 50 Ω.

Figure 34. Measured I/Q Output Noise Density⁵⁸

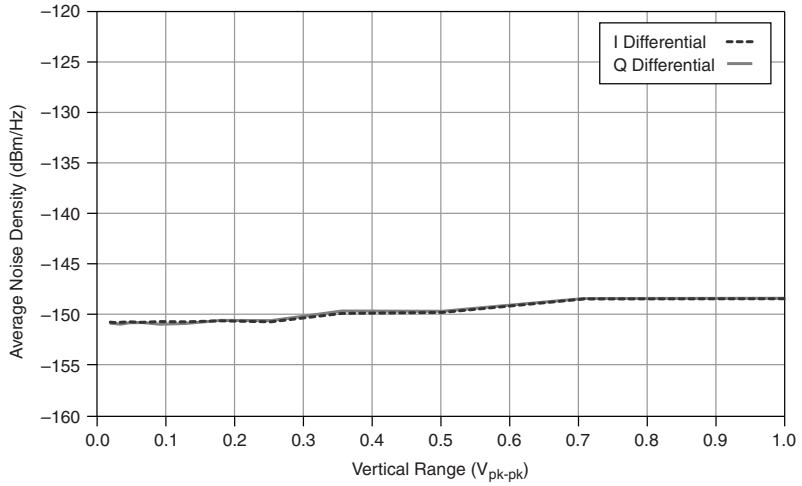

Harmonics

I/Q output second harmonic⁵⁹ (dBc)

23 °C ± 5 °C

-75, typical

0 °C to 55 °C

-73, typical

⁵⁹ Generated -1 dBFS CW at 9.9 MHz.

Figure 35. Measured I/Q Output Second Harmonic⁵⁹

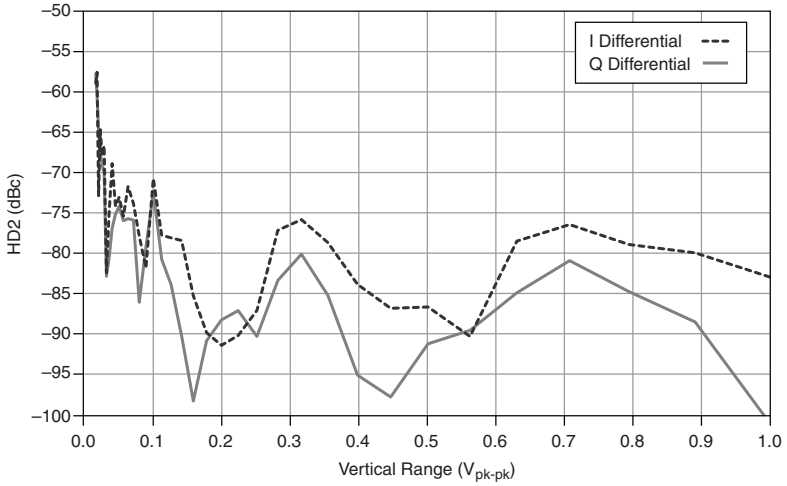

I/Q output third harmonic⁵⁹ (dBc)

23 °C ± 5 °C

-84, typical

0 °C to 55 °C

-83, typical

Figure 36. Measured I/Q Output Third Harmonic⁵⁹

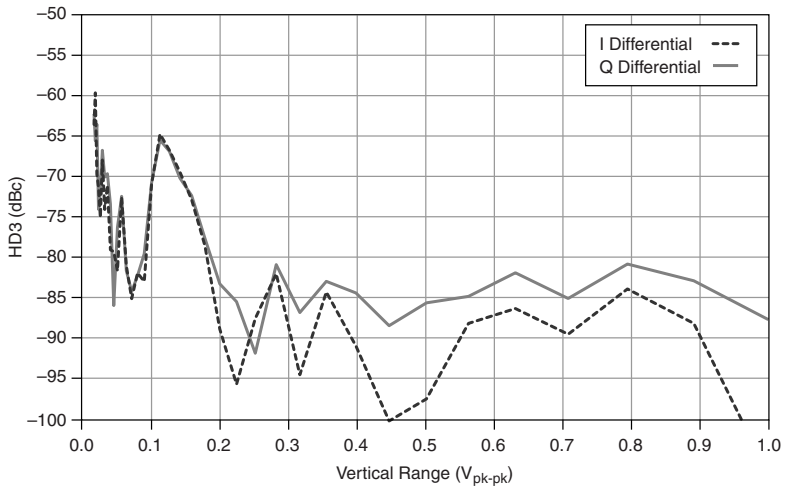
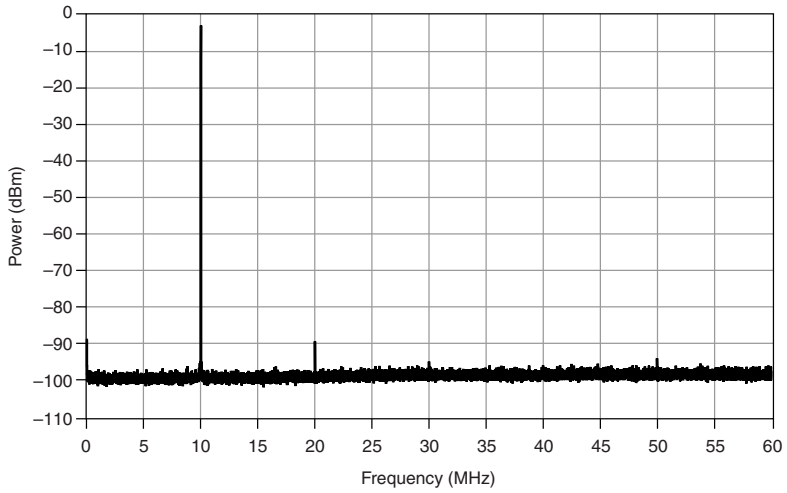

Figure 37. Measured I/Q Output Single Tone Spectrum



Third-Order Output Intermodulation

I/Q third-order output intermodulation⁶⁰ (IMD₃) (dBc)

23 °C ± 5 °C

-80, typical

0 °C to 55 °C

-75, typical

⁶⁰ Generating -7 dBFS CW tones at 9.9 MHz and 10.1 MHz.

Figure 38. Measured I/Q Output IMD_3^{60}

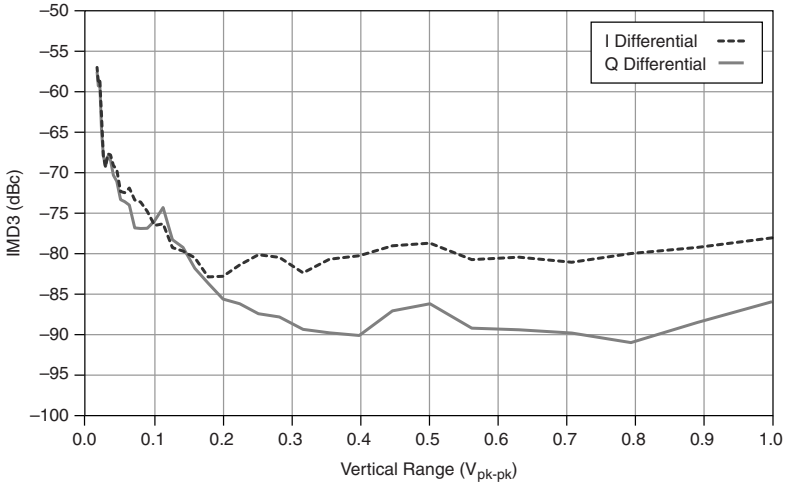
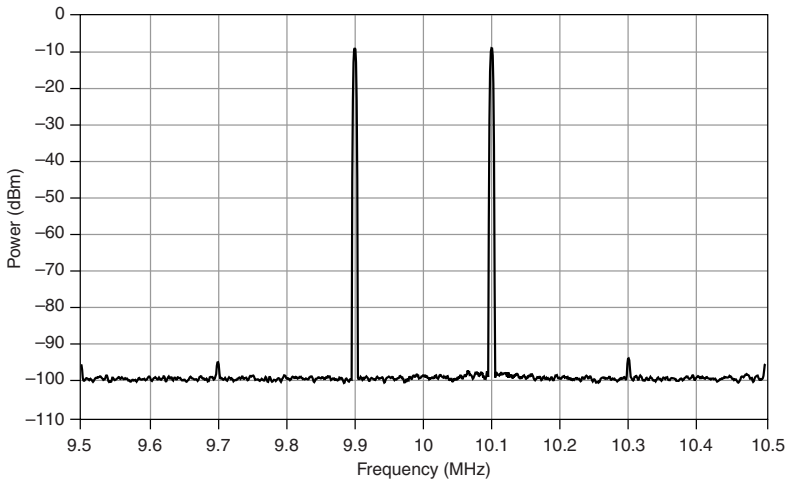

Figure 39. Measured I/Q Output Two-Tone Spectrum



Second-Order Output Intermodulation

I/Q second-order output intermodulation⁶¹ (IMD_2) (dBc)

23 °C ± 5 °C -80, typical

0 °C to 55 °C -75, typical

⁶¹ Generating -1 dBFS CW tones at 9.9 MHz and 10.1 MHz.

Figure 40. I/Q Output IMD₂⁶¹

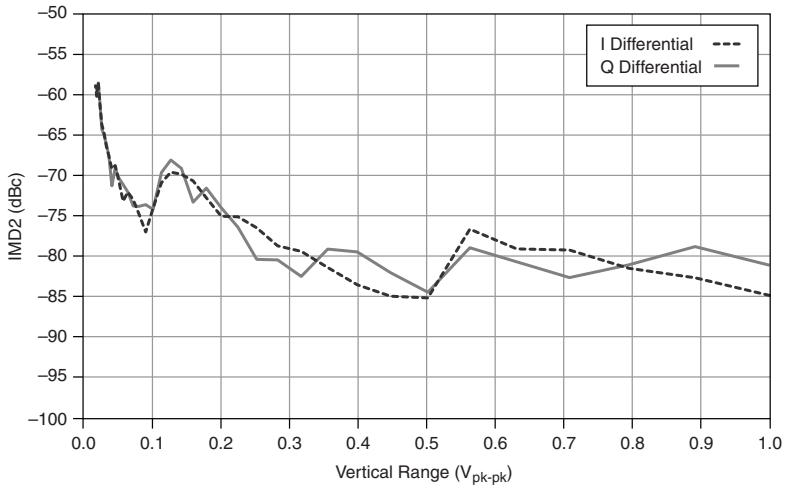

Application-Specific Modulation Quality

Typical performance assumes the PXIe-5645 is operating within $\pm 5^\circ\text{C}$ of the previous self-calibration temperature, and that the ambient temperature is 0°C to 55°C .

RF Application-Specific Modulation Quality

WLAN 802.11ac

OFDM⁶² -45 EVM (rms) dB, typical

WLAN 802.11n

Table 38. 802.11n OFDM EVM (rms) (dB), Typical

Frequency	20 MHz Bandwidth	40 MHz Bandwidth
2,412 MHz	-50	-50
5,000 MHz	-48	-46

Conditions: RF OUT loopback to RF IN; average power: -10 dBm; reference level: auto-leveled based on real-time average power measurement; 20 packets; 3/4 coding rate; 64 QAM.

⁶² Conditions: RF OUT loopback to RF IN; 5,800 MHz; 80 MHz bandwidth; average power: -30 dBm to -5 dBm; 20 packets; 16 OFDM data symbols; MCS=9; 256 QAM.

WLAN 802.11a/g/j/p

Table 39. 802.11a/g/j/p OFDM EVM (rms) (dB), Typical

Frequency	20 MHz Bandwidth
2,412 MHz	-53
5,000 MHz	-50
Conditions: RF OUT loopback to RF IN; average power: -10 dBm; reference level: auto-leveled based on real-time average power measurement; 20 packets; 3/4 coding rate; 64 QAM.	

WLAN 802.11g

Table 40. 802.11g DSSS-OFDM EVM (rms) (dB), Typical

Frequency	20 MHz Bandwidth
2,412 MHz	-53
5,000 MHz	-50
Conditions: RF OUT loopback to RF IN; average power: -10 dBm; reference level: auto-leveled based on real-time average power measurement; 20 packets; 3/4 coding rate; 64 QAM.	

WLAN 802.11b/g

DSSS⁶³

-48 EVM (rms) dB, typical

LTE

Table 41. SC-FDMA⁶⁴ (Uplink FDD) EVM (rms) (dB), Typical

Frequency	5 MHz Bandwidth	10 MHz Bandwidth	20 MHz Bandwidth
700 MHz	-56	-56	-54
900 MHz	-55	-55	-53
1,430 MHz	-54	-54	-53
1,750 MHz	-51	-50	-50

⁶³ Conditions: RF OUT loopback to RF IN; 2,412 MHz; 20 MHz bandwidth; average power -10 dBm; reference level: auto-leveled based on real-time average power measurement; averages: 10; pulse-shaping filter: Gaussian reference; CCK 11 Mbps.

⁶⁴ Single channel uplink only.

Table 41. SC-FDMA⁶⁴ (Uplink FDD) EVM (rms) (dB), Typical (Continued)

Frequency	5 MHz Bandwidth	10 MHz Bandwidth	20 MHz Bandwidth
1,900 MHz	-51	-50	-50
2,500 MHz	-50	-49	-49

WCDMA

Figure 41. WCDMA Measured Spectrum⁶⁵ (ACP)

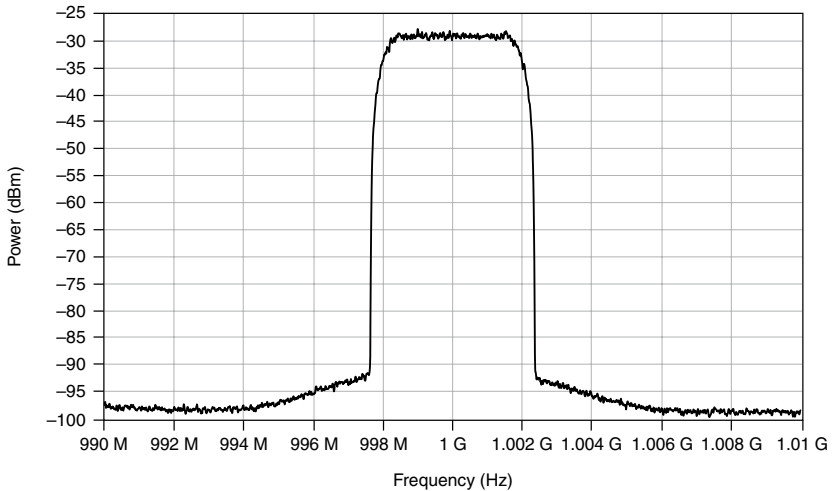

I/Q Baseband Application-Specific Modulation Quality

WLAN 802.11ac

OFDM⁶⁶

-53 EVM (rms) dB, nominal

WLAN 802.11n

OFDM⁶⁷

-54 EVM (rms) dB, nominal

⁶⁴ Single channel uplink only.

⁶⁵ Conditions: DL Test Model 1 (64DPCH); RF output level: -10 dBm average; RF OUT loopback to RF IN; measured results better than -66 dB.

⁶⁶ Conditions: I/Q OUT loopback to I/Q IN; 0.5 V_{pk-pk} range, differential; 80 MHz bandwidth; 20 packets; 16 OFDM data symbols; MCS=9; 256 QAM.

⁶⁷ Conditions: I/Q OUT loopback to I/Q IN; 0.5 V_{pk-pk} range, differential; 20 MHz, 40 MHz bandwidth; 20 packets; 3/4 coding rate; 64 QAM.

WLAN 802.11a/g/j/p

OFDM⁶⁸ -58 EVM (rms) dB, nominal

WLAN 802.11g

DSSS-OFDM⁶⁹ -56 EVM (rms) dB, nominal

WLAN 802.11b/g

DSSS⁷⁰ -51 EVM (rms) dB, nominal

LTE

SC-FDMA⁷¹ (Uplink FDD) -56 channel EVM (rms) dB, nominal

Baseband Characteristics

Analog-to-digital converters (ADCs)

Resolution	16 bits
Sample rate ⁷²	120 MS/s
I/Q data rate ⁷³	1.84 kS/s to 120 MS/s

Digital-to-analog converters (DACs)

Resolution	16 bits
Sample rate ⁷⁴	120 MS/s
I/Q data rate ⁷⁵	1.84 kS/s to 120 MS/s

Onboard FPGA

FPGA Xilinx Virtex-6 LX195T

LUTs 124,800

⁶⁸ Conditions: I/Q OUT loopback to I/Q IN; 0.5 V_{pk-pk} range, differential; 20 MHz bandwidth; 20 packets; 3/4 coding rate; 64 QAM.

⁶⁹ Conditions: I/Q OUT loopback to I/Q IN; 0.5 V_{pk-pk} range, differential; 20 MHz bandwidth; 20 packets; 3/4 coding rate; 64 QAM.

⁷⁰ Conditions: I/Q OUT loopback to I/Q IN; 0.5 V_{pk-pk} range, differential; 20 MHz bandwidth; Averages: 10; Pulse shaping filter: Gaussian; CCK: 11 Mbps.

⁷¹ Conditions: I/Q OUT loopback to I/Q IN; 0.5 V_{pk-pk} range, differential; 5 MHz, 10 MHz, 20 MHz bandwidth; single channel uplink only; 64 QAM PUSCH modulation.

⁷² ADCs are dual-channel components with each channel assigned to I and Q, respectively.

⁷³ I/Q data rates lower than 120 MS/s are achieved using fractional decimation.

⁷⁴ DACs are dual-channel components with each channel assigned to I and Q, respectively. DAC sample rate is internally interpolated to 960 MS/s, automatically configured.

⁷⁵ I/Q data rates lower than 120 MS/s are achieved using fractional interpolation.

Flip-flops	249,600
DSP48 slices	640
Embedded block RAM	12,384 kbits
Data transfers	DMA, interrupts, programmed I/O
Number of DMA channels	16

Onboard DRAM

Memory size	2 banks, 256 MB per bank
Theoretical maximum data rate	2.1 GB/s per bank

Onboard SRAM

Memory size	2 MB
Maximum data rate (read)	40 MB/s
Maximum data rate (write)	36 MB/s

Front Panel I/O

RF IN

Connector	SMA (female)
Input impedance	50 Ω, nominal, AC coupled
Maximum DC input voltage without damage	8 V
Absolute maximum input power ⁷⁶	+33 dBm (CW RMS)

Input Return Loss (Voltage Standing Wave Ratio (VSWR))

Table 42. Input Return Loss (dB) (VSWR)

Frequency	Typical
109 MHz $\leq f <$ 2.4 GHz	15.5 (1.40:1)
2.4 GHz $\leq f <$ 4 GHz	12.7 (1.60:1)
4 GHz $\leq f \leq$ 6 GHz	11.0 (1.78:1)
Return loss for frequencies <109 MHz is typically better than 14 dB (VSWR <1.5:1).	

⁷⁶ For modulated signals, peak instantaneous power not to exceed +36 dBm.

RF OUT

Connector	SMA (female)
Output impedance	50 Ω , nominal, AC coupled
Absolute maximum reverse power ⁷⁷	
<4 GHz	+33 dBm (CW RMS)
\geq 4 GHz	+30 dBm (CW RMS)

Output Return Loss (VSWR)

Table 43. Output Return Loss (dB) (VSWR)

Frequency	Typical
109 MHz $\leq f <$ 2 GHz	19.0 (1.25:1)
2 GHz $\leq f <$ 5 GHz	14.0 (1.50:1)
5 GHz $\leq f \leq$ 6 GHz	11.0 (1.78:1)
Return loss for frequencies < 109 MHz is typically better than 20 dB (VSWR < 1.22:1).	

CAL IN, CAL OUT

Connector	SMA (female)
Impedance	50 Ω , nominal



Caution Do not disconnect the cable that connects CAL IN to CAL OUT. Removing the cable from or tampering with the CAL IN or CAL OUT front panel connectors voids the product calibration and specifications are no longer warranted.

LO OUT (RF IN 0 and RF OUT 0)

Connectors	SMA (female)
Frequency range ⁷⁸	65 MHz to 6 GHz
Power	
LO OUT (RF IN 0) 65 MHz to 6 GHz	0 dBm \pm 2 dB, typical

⁷⁷ For modulated signals, peak instantaneous power not to exceed corresponding peak power of specified CW.

⁷⁸ When tuning to 65 MHz to 375 MHz using the RF IN channel, the exported LO is twice the RF frequency requested.

LO OUT (RF OUT 0)

65 MHz to 3.6 GHz	0 dBm \pm 2 dB, typical
\geq 3.6 GHz to 6 GHz	3 dBm \pm 2 dB, typical
Output power resolution	0.25 dB, nominal
Output impedance	50 Ω , nominal, AC coupled
Output return loss	>11.0 dB (VSWR <1.8:1), typical
Output isolation (state: disabled)	
<2.5 GHz tuned LO	-45 dBc, nominal
\geq 2.5 GHz tuned LO	-35 dBc, nominal

LO IN (RF IN 0 and RF OUT 0)

Connectors	SMA (female)
Frequency range ⁷⁹	65 MHz to 6 GHz
Expected input power	
LO IN (RF IN 0) 65 MHz to 6 GHz	0 dBm \pm 3 dB, nominal
LO IN (RF OUT 0)	
65 MHz to 3.6 GHz	0 dBm \pm 3 dB, nominal
\geq 3.6 GHz to 6 GHz	3 dBm \pm 1 dB, nominal
Input impedance	50 Ω , nominal, AC coupled
Input return loss	>11.7 dB (VSWR <1.7:1), typical
Absolute maximum power	+15 dBm
Maximum DC voltage	\pm 5 VDC

I/Q IN 0

Connectors	MCX
DC input resistance	
Single-ended	50 Ω , nominal
Differential	100 Ω , nominal
Input coupling, per terminal	DC
Input return loss \leq 40 MHz	>-28 dB, nominal

⁷⁹ When tuning to 65 MHz to 375 MHz using the RF IN channel, the exported LO is twice the RF frequency requested.

Input type	Single-ended ⁸⁰ , differential
Number of channels	2

I/Q OUT 0

Connectors	MCX
DC output resistance	
Single-ended	50 Ω , nominal
Differential	100 Ω , nominal
Output coupling, per terminal	DC
Output return loss \leq 40 MHz	$>$ -28 dB, nominal
Output type	Single-ended ⁸¹ , differential
Number of channels	2

REF IN

Connector	SMA (female)
Frequency	10 MHz
Tolerance ⁸²	$\pm 10 \times 10^{-6}$
Amplitude	
Square	0.7 V _{pk-pk} to 5.0 V _{pk-pk} into 50 Ω , typical
Sine ⁸³	1.4 V _{pk-pk} to 5.0 V _{pk-pk} into 50 Ω , typical
Input impedance	50 Ω , nominal
Coupling	AC

REF OUT

Connector	SMA (female)
Frequency	
Reference Clock ⁸⁴	10 MHz, nominal
Sample Clock	120 MHz, nominal
Amplitude	1.65 V _{pk-pk} into 50 Ω , nominal

⁸⁰ Negative terminal must be externally terminated in single-ended mode.

⁸¹ Negative terminal must be externally terminated in single-ended mode.

⁸² $Frequency\ Accuracy = Tolerance \times Reference\ Frequency$

⁸³ 1 V_{rms} to 3.5 V_{rms}, typical. Jitter performance improves with increased slew rate of input signal.

⁸⁴ Refer to the [Internal Frequency Reference](#) for accuracy.

Output impedance	50 Ω , nominal
Coupling	AC

PFI 0

Connector	SMA (female)
Voltage levels ⁸⁵	
Absolute maximum input range	-0.5 V to 5.5 V
V _{IL}	0.8 V
V _{IH}	2.0 V
V _{OL}	0.2 V with 100 μ A load
V _{OH}	2.9 V with 100 μ A load
Input impedance	10 k Ω , nominal
Output impedance	50 Ω , nominal
Maximum DC drive strength	24 mA
Minimum required direction change latency ⁸⁶	48 ns + 1 clock cycle

DIGITAL I/O

Connector	VHDCI
-----------	-------

Table 44. DIGITAL I/O Signal Characteristics

Signal	Direction	Port Width
DIO <23..20>	Bidirectional, per port	4
DIO <19..16>	Bidirectional, per port	4
DIO <15..12>	Bidirectional, per port	4
DIO <11..8>	Bidirectional, per port	4
DIO <7..4>	Bidirectional, per port	4
DIO <3..0>	Bidirectional, per port	4
PFI 1	Bidirectional	1
PFI 2	Bidirectional	1

⁸⁵ Voltage levels are guaranteed by design through the digital buffer specifications.

⁸⁶ Clock cycle refers to the FPGA clock domain used for direction control.

Table 44. DIGITAL I/O Signal Characteristics (Continued)

Signal	Direction	Port Width
Clock In	Input	1
Clock Out	Output	1

Voltage levels⁸⁷

Absolute maximum input range	-0.5 V to 4.5 V
V _{IL}	0.8 V
V _{IH}	2.0 V
V _{OL}	0.2 V with 100 μ A load
V _{OH}	2.9 V with 100 μ A load

Input impedance

DIO <23..0>, CLK IN	10 k Ω , nominal
PFI 1, PFI 2	100 k Ω pull up, nominal

Output impedance	50 Ω , nominal
------------------	-----------------------

Maximum DC drive strength	12 mA
---------------------------	-------

Minimum required direction change latency ⁸⁸	48 ns + 1 clock cycle
---------------------------------------------------------	-----------------------

Maximum toggle rate	125 MHz, typical
---------------------	------------------

⁸⁷ Voltage levels are guaranteed by design through the digital buffer specifications.

⁸⁸ Clock cycle refers to the FPGA clock domain used for direction control.

Figure 42. DIGITAL I/O VHDCI Connector

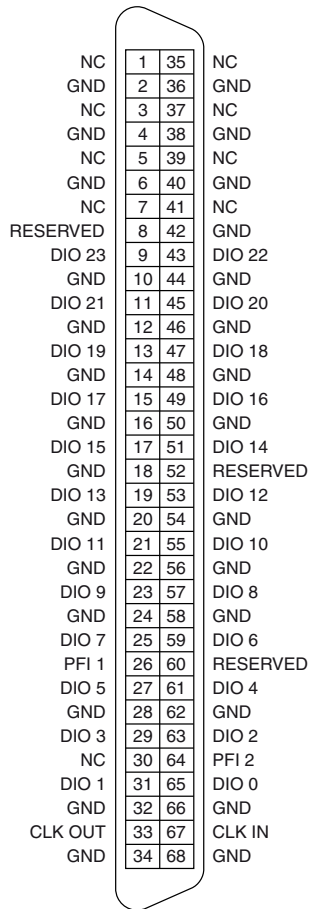

Power Requirements

Table 45. Power Requirements

Voltage (V_{DC})	Typical Current (A)	Maximum Current (A)
+3.3	4.9	5.3
+12	3.3	4.2

Power is 56 W, typical. Consumption is from both PXI Express backplane power connectors.

Calibration

Interval	1 year
----------	--------



Note For the two-year calibration interval, add 0.2 dB to one-year specifications for *Absolute Amplitude Accuracy*, RF input *Frequency Response*, *Output Power Level Accuracy*, and RF output *Frequency Response*.

Physical Characteristics

PXIe-5645 module	3U, four slot, PXI Express module 8.1 cm × 12.9 cm × 21.1 cm 3.2 in × 5.6 in × 8.3 in
Weight	1,758 g (62.0 oz)

Environment

Maximum altitude	2,000 m (800 mbar) (at 25 °C ambient temperature)
------------------	---------------------------------------------------

Pollution Degree	2
------------------	---

Indoor use only.

Operating Environment

Ambient temperature range	0 °C to 55 °C (Tested in accordance with IEC 60068-2-1 and IEC 60068-2-2. Meets MIL-PRF-28800F Class 3 low temperature limit and MIL-PRF-28800F Class 2 high temperature limit.)
---------------------------	----------------------------------------------------------------------------------------------------------------------------------------------------------------------------------

Relative humidity range	10% to 90%, noncondensing (Tested in accordance with IEC 60068-2-56.)
-------------------------	-----------------------------------------------------------------------

Storage Environment

Ambient temperature range	-40 °C to 71 °C (Tested in accordance with IEC 60068-2-1 and IEC 60068-2-2. Meets MIL-PRF-28800F Class 3 limits.)
---------------------------	-------------------------------------------------------------------------------------------------------------------

Relative humidity range	5% to 95%, noncondensing (Tested in accordance with IEC 60068-2-56.)
-------------------------	----------------------------------------------------------------------

Shock and Vibration

Operating shock	30 g peak, half-sine, 11 ms pulse (Tested in accordance with IEC 60068-2-27. Meets MIL-PRF-28800F Class 2 limits.)
Random vibration	
Operating	5 Hz to 500 Hz, 0.3 g _{rms} (Tested in accordance with IEC 60068-2-64.)
Nonoperating	5 Hz to 500 Hz, 2.4 g _{rms} (Tested in accordance with IEC 60068-2-64. Test profile exceeds the requirements of MIL-PRF-28800F, Class 3.)

Compliance and Certifications

Safety

This product is designed to meet the requirements of the following electrical equipment safety standards for measurement, control, and laboratory use:

- IEC 61010-1, EN 61010-1
- UL 61010-1, CSA C22.2 No. 61010-1



Note For UL and other safety certifications, refer to the product label or the [Online Product Certification](#) section.

Electromagnetic Compatibility

This product meets the requirements of the following EMC standards for electrical equipment for measurement, control, and laboratory use:

- EN 61326-1 (IEC 61326-1): Class A emissions; Basic immunity
- EN 55011 (CISPR 11): Group 1, Class A emissions
- EN 55022 (CISPR 22): Class A emissions
- EN 55024 (CISPR 24): Immunity
- AS/NZS CISPR 11: Group 1, Class A emissions
- AS/NZS CISPR 22: Class A emissions
- FCC 47 CFR Part 15B: Class A emissions
- ICES-001: Class A emissions



Note In the United States (per FCC 47 CFR), Class A equipment is intended for use in commercial, light-industrial, and heavy-industrial locations. In Europe, Canada, Australia, and New Zealand (per CISPR 11), Class A equipment is intended for use only in heavy-industrial locations.



Note Group 1 equipment (per CISPR 11) is any industrial, scientific, or medical equipment that does not intentionally generate radio frequency energy for the treatment of material or inspection/analysis purposes.



Note For EMC declarations, certifications, and additional information, refer to the [Online Product Certification](#) section.

CE Compliance

This product meets the essential requirements of applicable European Directives, as follows:

- 2014/35/EU; Low-Voltage Directive (safety)
- 2014/30/EU; Electromagnetic Compatibility Directive (EMC)

Online Product Certification

Refer to the product Declaration of Conformity (DoC) for additional regulatory compliance information. To obtain product certifications and the DoC for this product, visit ni.com/certification, search by model number or product line, and click the appropriate link in the Certification column.

Environmental Management

NI is committed to designing and manufacturing products in an environmentally responsible manner. NI recognizes that eliminating certain hazardous substances from our products is beneficial to the environment and to NI customers.

For additional environmental information, refer to the *Minimize Our Environmental Impact* web page at ni.com/environment. This page contains the environmental regulations and directives with which NI complies, as well as other environmental information not included in this document.

Waste Electrical and Electronic Equipment (WEEE)



EU Customers At the end of the product life cycle, all NI products must be disposed of according to local laws and regulations. For more information about how to recycle NI products in your region, visit ni.com/environment/weee.

电子信息产品污染控制管理办法（中国 RoHS）



中国客户 National Instruments 符合中国电子信息产品中限制使用某些有害物质指令 (RoHS)。关于 National Instruments 中国 RoHS 合规性信息，请登录 ni.com/environment/rohs_china。(For information about China RoHS compliance, go to ni.com/environment/rohs_china.)

Information is subject to change without notice. Refer to the *NI Trademarks and Logo Guidelines* at ni.com/trademarks for information on NI trademarks. Other product and company names mentioned herein are trademarks or trade names of their respective companies. For patents covering NI products/technology, refer to the appropriate location: **Help»Patents** in your software, the `patents.txt` file on your media, or the *National Instruments Patent Notice* at ni.com/patents. You can find information about end-user license agreements (EULAs) and third-party legal notices in the `readme` file for your NI product. Refer to the *Export Compliance Information* at ni.com/legal/export-compliance for the NI global trade compliance policy and how to obtain relevant HTS codes, ECCNs, and other import/export data. NI MAKES NO EXPRESS OR IMPLIED WARRANTIES AS TO THE ACCURACY OF THE INFORMATION CONTAINED HEREIN AND SHALL NOT BE LIABLE FOR ANY ERRORS. U.S. Government Customers: The data contained in this manual was developed at private expense and is subject to the applicable limited rights and restricted data rights as set forth in FAR 52.227-14, DFAR 252.227-7014, and DFAR 252.227-7015.

© 2013—2017 National Instruments. All rights reserved.

373914F-01 June 26, 2017