

## COMPREHENSIVE SERVICES

We offer competitive repair and calibration services, as well as easily accessible documentation and free downloadable resources.

## SELL YOUR SURPLUS

We buy new, used, decommissioned, and surplus parts from every NI series. We work out the best solution to suit your individual needs.

 Sell For Cash    Get Credit    Receive a Trade-In Deal

## OBSOLETE NI HARDWARE IN STOCK & READY TO SHIP

We stock **New**, **New Surplus**, **Refurbished**, and **Reconditioned** NI Hardware.



*Bridging the gap between the manufacturer and your legacy test system.*

 1-800-915-6216

 [www.apexwaves.com](http://www.apexwaves.com)

 [sales@apexwaves.com](mailto:sales@apexwaves.com)

*All trademarks, brands, and brand names are the property of their respective owners.*

**Request a Quote**

 **CLICK HERE**

**PXIe-5668**

PRODUCT FLYER

# PXI Vector Signal Analyzers

## CONTENTS

[PXI RF Vector Signal Analyzers](#)

[Detail View of PXIe-5668 Vector Signal Analyzer](#)

[Key Features](#)

[NI-RFSA Soft Front Panel](#)

[NI-RFmx Application Programming Interface \(API\)](#)

[Platform-Based Approach to Test and Measurement](#)

[PXI Instrumentation](#)

[Hardware Services](#)

# PXI Vector Signal Analyzers

PXI-5661, PXIe-5663E, PXIe-5665, PXIe-5667, and PXIe-5668



- **Software:** Includes interactive soft front panel, API support for LabVIEW and text-based languages, shipping examples, and detailed help files
- Up to 765 MHz of instantaneous bandwidth
- Current measurements up to 3 A
- Best-in-class dynamic range, noise floor, and phase noise
- Support for wireless standards including 802.11ax and LTE Advanced
- LabVIEW-programmable FPGA

## Built for Automated Test and Measurement

PXI Vector Signal Analyzers (VSAs) feature a wide frequency range, real-time signal analysis, and advanced signal processing. These instruments can perform measurements for a broad range of wireless technologies such as GSM, EDGE, WCDMA, LTE-Advance Pro, 5G, Wireless LAN, and Bluetooth. Select models also feature a LabVIEW-programmable FPGA that you can customize for advanced measurement applications. PXI VSAs are ideal for microwave test, wireless test, RADAR test, spectral monitoring, software-defined radio (SDR), radio monitoring, interference detection, signals intelligence, and other applications.

NI's VSA portfolio is highlighted by the PXIe-5668, which offers up to 765 MHz of instantaneous bandwidth with industry-leading dynamic range, and best-in-class measurement performance and speed.

Table 1. NI offers RF Vector Signal Analyzers ranging from 20 MHz to 765 MHz Bandwidth

	PXI-5661	PXIe-5663	PXIe-5665	PXIe-5667	PXI-5668
Frequency Range	9 kHz to 2.7 GHz	10 MHz to 6.6 GHz	20 Hz to 3.6 GHz / 14 GHz	20 Hz to 3.6 GHz / 7 GHz	20 Hz to 26.5 GHz
Bandwidth	20 MHz	50 MHz	25 MHz or 50 MHz	25 MHz or 50 MHz	Up to 765 MHz
Phase Noise (10 kHz offset) at 1 GHz	-90 dBc/Hz	-105 dBc/Hz	-129 dBc/Hz*	-126 dBc/Hz*	-129 dBc/Hz
Absolute Amplitude Accuracy	±0.6 dB	±0.65 dB	± 0.1 dB	± 0.1 dB	± 0.2 dB
Average Noise Floor	-122 dBm/Hz	-158 dBm/Hz	-165 dBm/Hz	-165 dBm/Hz	-167 dBm/Hz
Architecture	Multi-Stage	Single-Stage	Multi-Stage	Multi-Stage	Multi-Stage
List Mode	N/A	•	•	•	•
Peer-to-Peer Streaming	N/A	•	•	•	•
Slots	3	3	5 to 7	7	7

## Detailed View of PXIe-5668 Vector Signal Analyzer

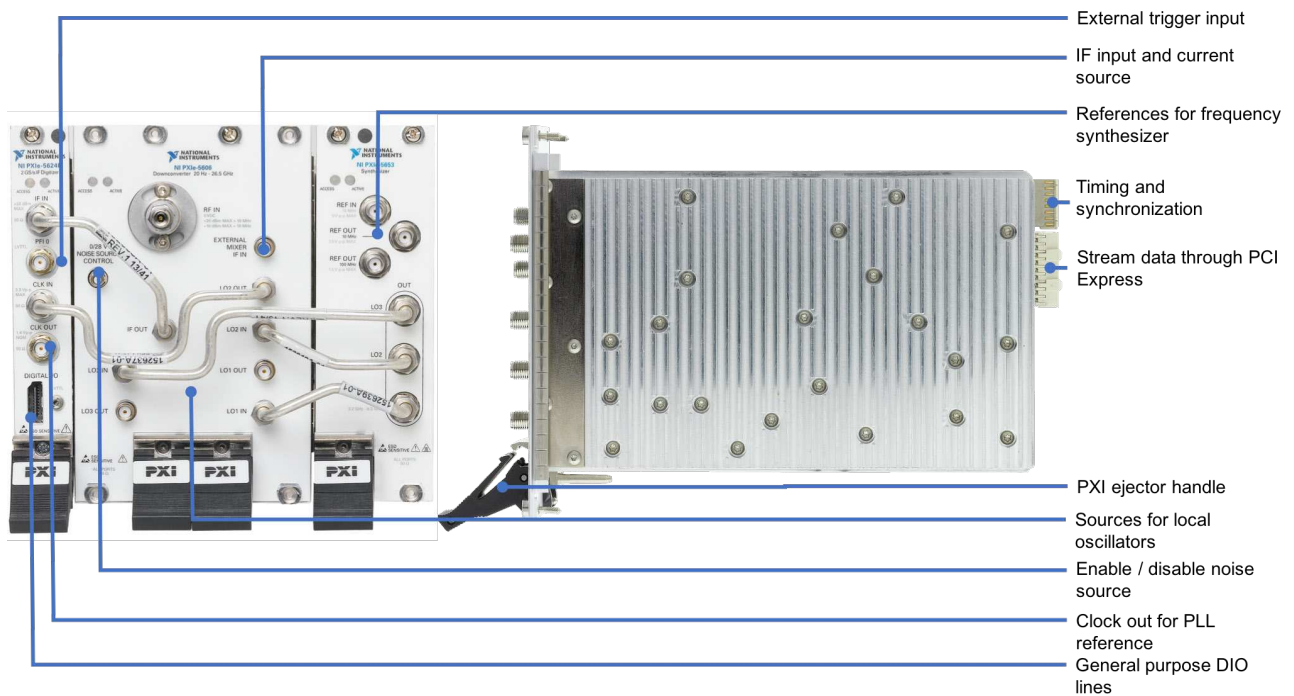

# Key Features

## Excellent RF Measurement Performance

NI VSAs feature a unique combination of low phase noise and noise floor, high second- and third-order intercepts, and excellent dynamic range, making them well suited for applications ranging from adjacent channel leakage ratio (ACLR) measurements to spurs and harmonics measurements. In Figure 1, the dynamic range chart illustrates both noise and linearity as a function of mixer level for the PXIe-5668 VSA.

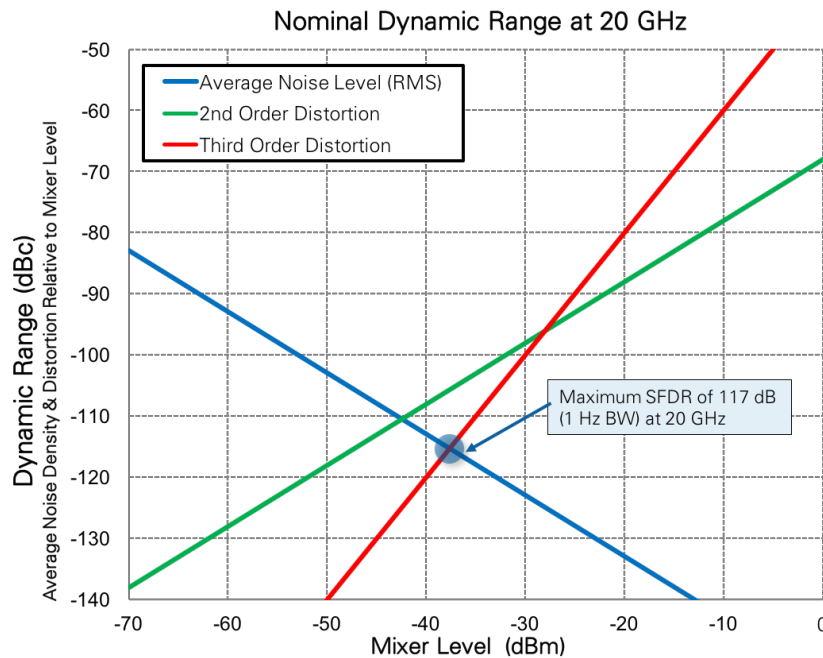

Figure 1. PXIe-5668 dynamic range chart at 20 GHz

The excellent dynamic range performance of the PXIe-5668 gives it the ability to accurately perform measurements ranging from intermodulation distortion (IMD) to adjacent channel power (ACP) to error vector magnitude (EVM). In addition to cost-effective R&D-grade analog and RF/microwave performance, NI VSAs offer an industry-leading measurement speed with NI-RFmx software, allowing you to perform spectrum and demodulation measurements 3x to 10x faster than traditional instruments.

## Wide Instantaneous Bandwidth

The ability to measure extremely wide bandwidths in a single acquisition is useful for applications ranging from EVM measurements of wideband wireless signals such as 802.11ax to radar pulse measurements of narrow pulses. Leveraging fast sampling, high-linearity ADCs, and wide-band internal calibration mechanisms, the NI VSAs offer 25 MHz, 50 MHz, 320 MHz and 765 MHz of instantaneous RF bandwidth with excellent measurement accuracy, as shown in Figure 2. The wide instantaneous bandwidth also allows faster spectrum measurements in scenarios in which the span is smaller than the instantaneous bandwidth of the instrument.

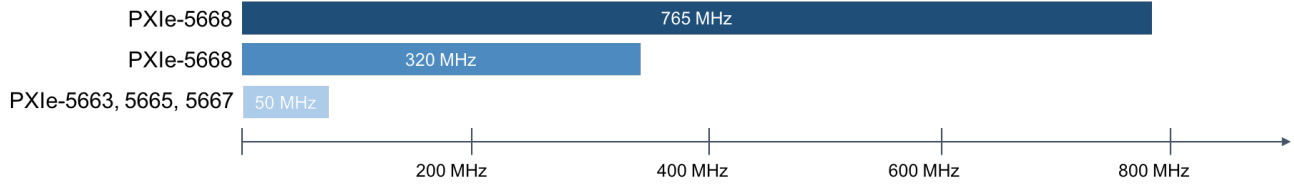

Figure 2. Available instantaneous RF bandwidth for NI VSAs

## Flexibility

Another key attribute of the NI VSA is the flexibility with which you can reconfigure it, embedding custom signal processing algorithms on the instrument itself. For example, using LabVIEW FPGA example code, you can configure PXIe-5668 VSA as a real-time spectrum analyzer (RTSA), as shown in Figure 3. With the RTSA personality, you can analyze extremely wide bandwidths of spectrum in real time without gaps in the time-domain record.

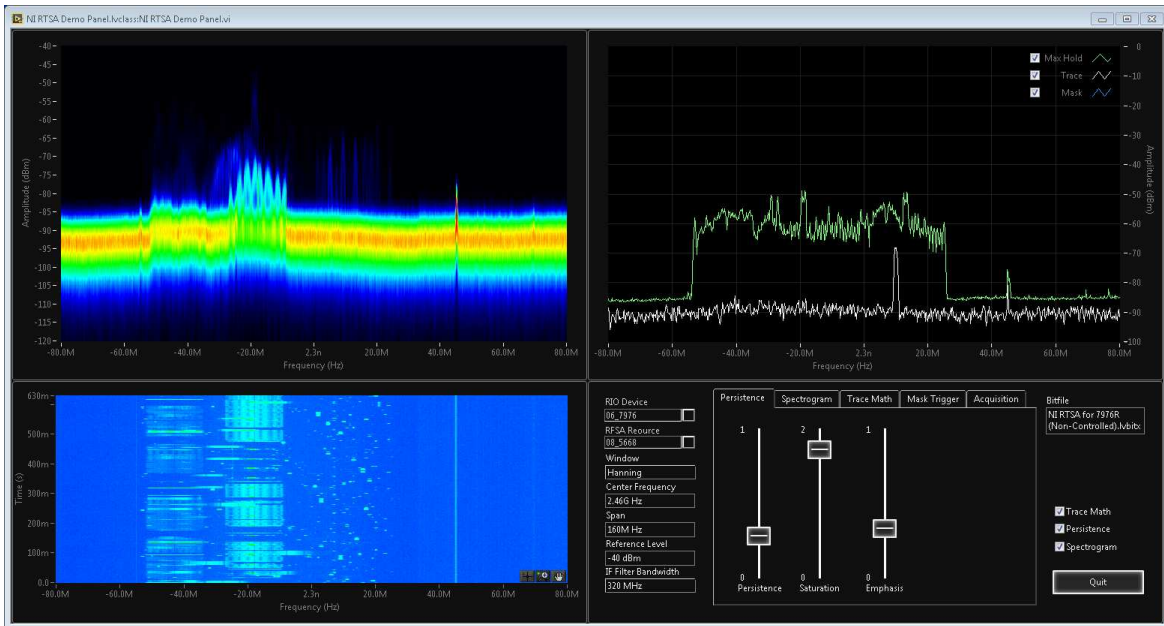

Figure 3. Front panel for LabVIEW-based RTSA application

Because of the modular architecture of NI VSAs, additional downconverter and digitizer modules support multichannel receiver configurations. For example, the PXIe-5668 provides the ability to share the local oscillator (LO) and other timing signals across multiple modules and allows for phase-coherence between each RF channel. The phase-coherence of multichannel receivers is important in applications ranging from direction finding to beamforming and multiple input, multiple output (MIMO) device testing. Figure 4 shows an example configuration of a two-channel RF signal analyzer.



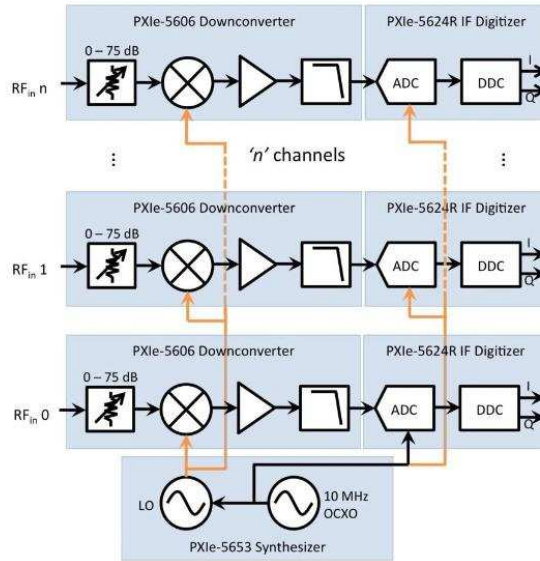

Figure 4. Configuration of multiple PXIe-5668 instruments for multichannel, phase-coherent RF signal acquisition

## NI-RFSA Soft Front Panel

The NI-RFSA Soft Front Panel helps you quickly view and analyze RF signals using PXI hardware from NI. The soft front panel features built-in measurements such as third-order intercept (TOI), complementary cumulative distribution function (CCDF), adjacent channel power ratio (ACPR), occupied bandwidth (OBW), channel power, and transmit power. With these one-button measurements, you can quickly measure, display, and store results, which makes NI PXI instruments ideal for characterization and validation environments.

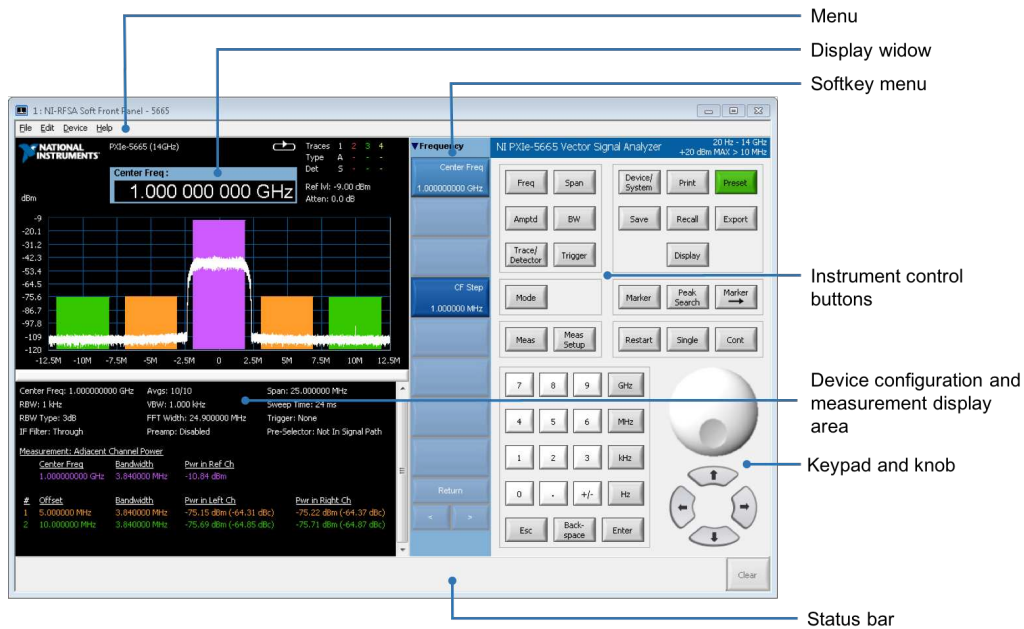

Figure 5. Users can configure the VSA for quick measurements using the NI-RFSA soft front panel; other interactive examples are also available and act as soft front panels for different wireless standards.

# NI-RFmx Application Programming Interface (API)

NI-RFmx provides an intuitive programming API that offers both ease of use and advanced measurement configuration. It offers a highly-optimized API to perform tasks ranging from measurements on digital and analog modulated signals to RF spectral measurements including channel power, adjacent channel power, and power spectrum. It also allows users to automate their programs with accurate, high-performance standard-based measurements for LTE-A, WCDMA/HSPA+, GSM/EDGE, Bluetooth, Bluetooth LE and more. In addition to the support for cellular and general purpose measurements with RFmx, NI offers wireless test standards software for GPS/GNSS simulation and FM/RDS, and the [WLAN Test Toolkit](#) gives you direct and fine control over the generation and analysis of IEEE 802.11a/b/g/n/ac and ax signals, as well as 802.11j/p/ah/af waveforms, with industry-leading speed and accuracy.

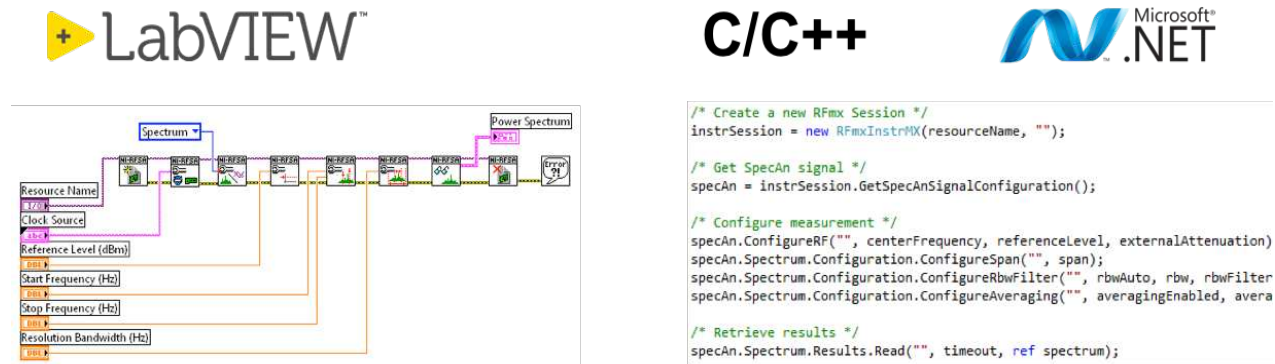

Figure 6. Power spectrum measurements performed using NI RFmx in LabVIEW and C

Figure 6 illustrates a power spectrum measurement using an RFmx LabVIEW example with eight function calls. Engineers can get started with one of more than 100 example programs in C, .NET, and LabVIEW that are designed to make instrument automation straightforward.

The NI-RFmx API includes high-level parameters that intelligently optimize instrument settings to help you achieve the highest quality measurement with the fewest software calls. Additionally, NI-RFmx has features that vastly simplify the software complexity of multi-measurement parallelism and multi-DUT measurements. The modular software architecture offers access to lower level NI-RFSA instrument- and application-specific functions that provide the ultimate balance of ease of use and test code flexibility. NI-RFmx works with all NI software-designed VSTs and preserves the usage of NI-RFSA instrument driver FPGA extensions, which are available only on LabVIEW FPGA-enabled products. As a result, users can achieve industry-leading measurement speeds using the latest processor technologies and easy-to-program multithreaded measurements for test time reduction.



# Platform-Based Approach to Test and Measurement



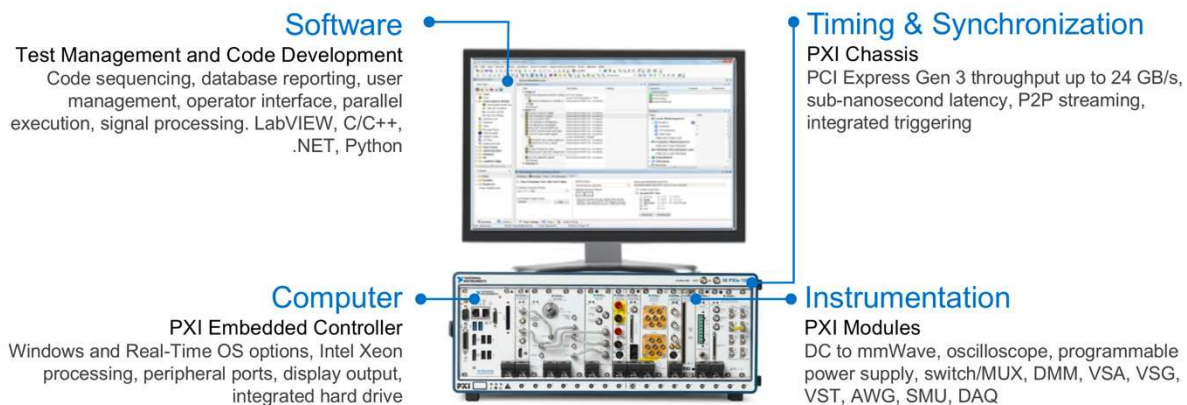

## What Is PXI?

Powered by software, PXI is a rugged PC-based platform for measurement and automation systems. PXI combines PCI electrical-bus features with the modular, Eurocard packaging of CompactPCI and then adds specialized synchronization buses and key software features. PXI is both a high-performance and low-cost deployment platform for applications such as manufacturing test, military and aerospace, machine monitoring, automotive, and industrial test. Developed in 1997 and launched in 1998, PXI is an open industry standard governed by the PXI Systems Alliance (PXISA), a group of more than 70 companies chartered to promote the PXI standard, ensure interoperability, and maintain the PXI specification.



## Integrating the Latest Commercial Technology

By leveraging the latest commercial technology for our products, we can continually deliver high-performance and high-quality products to our users at a competitive price. The latest PCI Express Gen 3 switches deliver higher data throughput, the latest Intel multicore processors facilitate faster and more efficient parallel (multisite) testing, the latest FPGAs from Xilinx help to push signal processing algorithms to the edge to accelerate measurements, and the latest data converters from TI and ADI continually increase the measurement range and performance of our instrumentation.

<p>HIGHER DATA THROUGHPUT</p>  <p>PCI Express Gen 3</p>	<p>PARALLEL TEST EXECUTION</p>  <p>Multicore Processors</p>	<p>MEASUREMENT ACCELERATION</p>  <p>FPGAs</p>	<p>INCREASED MEASUREMENT RANGE</p>  <p>Data Converters</p>
--	--	---	---

# PXI Instrumentation

NI offers more than 600 different PXI modules ranging from DC to mmWave. Because PXI is an open industry standard, nearly 1,500 products are available from more than 70 different instrument vendors. With standard processing and control functions designated to a controller, PXI instruments need to contain only the actual instrumentation circuitry, which provides effective performance in a small footprint. Combined with a chassis and controller, PXI systems feature high-throughput data movement using PCI Express bus interfaces and sub-nanosecond synchronization with integrated timing and triggering.



## Oscilloscopes

Sample at speeds up to 12.5 GS/s with 5 GHz of analog bandwidth, featuring numerous triggering modes and deep onboard memory



## Digital Multimeters

Perform voltage (up to 1000 V), current (up to 3A), resistance, inductance, capacitance, and frequency/period measurements, as well as diode tests



## Digital Instruments

Perform characterization and production test of semiconductor devices with timing sets and per channel pin parametric measurement unit (PPMU)



## Waveform Generators

Generate standard functions including sine, square, triangle, and ramp as well as user-defined, arbitrary waveforms



## Frequency Counters

Perform counter timer tasks such as event counting and encoder position, period, pulse, and frequency measurements



## Source Measure Units

Combine high-precision source and measure capability with high channel density, deterministic hardware sequencing, and SourceAdapt transient optimization



## Power Supplies & Loads

Supply programmable DC power, with some modules including isolated channels, output disconnect functionality, and remote sense



## FlexRIO Custom Instruments & Processing

Provide high-performance I/O and powerful FPGAs for applications that require more than standard instruments can offer



## Switches (Matrix & MUX)

Feature a variety of relay types and row/column configurations to simplify wiring in automated test systems



## Vector Signal Transceivers

Combine a vector signal generator and vector signal analyzer with FPGA-based, real-time signal processing and control



## GPIB, Serial, & Ethernet

Integrate non-PXI instruments into a PXI system through various instrument control interfaces



## Data Acquisition Modules

Provide a mix of analog I/O, digital I/O, counter/timer, and trigger functionality for measuring electrical or physical phenomena

# Hardware Services

All NI hardware includes a one-year warranty for basic repair coverage, and calibration in adherence to NI specifications prior to shipment. PXI systems also include basic assembly and a functional test. NI offers additional entitlements to improve uptime and lower maintenance costs with service programs for hardware. Learn more at [ni.com/services/hardware](http://ni.com/services/hardware).

	Standard	Premium	Description
Program Duration	3 or 5 years	3 or 5 years	Length of service program
Extended Repair Coverage	•	•	NI restores your device's functionality and includes firmware updates and factory calibration.
System Configuration, Assembly, and Test <sup>1</sup>	•	•	NI technicians assemble, install software in, and test your system per your custom configuration prior to shipment.
Advanced Replacement <sup>2</sup>		•	NI stocks replacement hardware that can be shipped immediately if a repair is needed.
System Return Material Authorization (RMA) <sup>1</sup>		•	NI accepts the delivery of fully assembled systems when performing repair services.
Calibration Plan (Optional)	Standard	Expedited <sup>3</sup>	NI performs the requested level of calibration at the specified calibration interval for the duration of the service program.

<sup>1</sup>This option is only available for PXI, CompactRIO, and CompactDAQ systems.

<sup>2</sup>This option is not available for all products in all countries. Contact your local NI sales engineer to confirm availability.

<sup>3</sup>Expedited calibration only includes traceable levels.

## PremiumPlus Service Program

NI can customize the offerings listed above, or offer additional entitlements such as on-site calibration, custom sparring, and life-cycle services through a PremiumPlus Service Program. Contact your NI sales representative to learn more.

## Technical Support

Every NI system includes a 30-day trial for phone and e-mail support from NI engineers, which can be extended through a [Software Service Program \(SSP\)](#) membership. NI has more than 400 support engineers available around the globe to provide local support in more than 30 languages. Additionally, take advantage of NI's award winning [online resources](#) and [communities](#).

©2017 National Instruments. All rights reserved. LabVIEW, National Instruments, NI, NI TestStand, and ni.com are trademarks of National Instruments. Other product and company names listed are trademarks or trade names of their respective companies. The contents of this Site could contain technical inaccuracies, typographical errors or out-of-date information. Information may be updated or changed at any time, without notice. Visit [ni.com/manuals](http://ni.com/manuals) for the latest information.

29 August 2017