

COMPREHENSIVE SERVICES

We offer competitive repair and calibration services, as well as easily accessible documentation and free downloadable resources.

SELL YOUR SURPLUS

We buy new, used, decommissioned, and surplus parts from every NI series. We work out the best solution to suit your individual needs.

 Sell For Cash  Get Credit  Receive a Trade-In Deal

OBSOLETE NI HARDWARE IN STOCK & READY TO SHIP

We stock **New**, **New Surplus**, **Refurbished**, and **Reconditioned** NI Hardware.



Bridging the gap between the manufacturer and your legacy test system.

 1-800-915-6216

 www.apexwaves.com

 sales@apexwaves.com

All trademarks, brands, and brand names are the property of their respective owners.

Request a Quote

 **CLICK HERE**

PXIe-6366

CALIBRATION PROCEDURE

DAQ Multifunction I/O (MIO) and Simultaneous Multifunction I/O (SMIO) Devices

B/E/M/S/X Series with NI-DAQmx

This document contains the verification and adjustment procedures for the National Instruments B, E, M, S, and X Series data acquisition (DAQ) devices. For more information about calibration solutions, visit ni.com/calibration.

Contents

Software.....	2
Documentation.....	2
Password.....	4
Test Equipment.....	4
Test Conditions.....	6
Calibration Procedure.....	6
Initial Setup.....	7
Self-Calibration.....	7
Checking Device Temperature Changes.....	7
Verification.....	9
Analog Input Verification.....	9
Analog Output Verification.....	15
Counter Verification.....	18
Adjustment.....	20
EEPROM Update.....	22
Reverification.....	22
Test Limits.....	22
B Series Test Limits.....	23
NI 6010 (16-Bit Resolution).....	23
NI 6013/6014/6015/6016 (16-Bit Resolution).....	24
E Series Test Limits.....	27
NI 6011E (16-Bit Resolution).....	27
NI 6023E/6024E/6025E (12-Bit Resolution).....	30
NI DAQCard-6024E (12-Bit Resolution).....	32
NI 6030E/6031E/6032E/6033E (16-Bit Resolution).....	33
NI 6034E/6035E/6036E (16-Bit Resolution).....	37
NI DAQCard-6036E (16-Bit Resolution).....	39
NI 6040E (12-Bit Resolution).....	40
NI 6052E (16-Bit Resolution).....	44
NI DAQCard-6062E (12-Bit Resolution).....	48
NI 6070E/6071E (12-Bit Resolution).....	51

M Series Test Limits.....	55
NI USB-6210/6211/6215/6218 (16-Bit Resolution).....	55
NI USB-6212/6216 (16-Bit Resolution).....	56
NI 6220/6221/6224/6225/6229 (16-Bit Resolution).....	58
NI 6250/6251/6254/6255/6259 (16-Bit Resolution).....	60
NI 6280/6281/6284/6289 (18-Bit Resolution).....	63
S Series Test Limits	68
NI 6110/6111 (12-Bit Resolution).....	68
NI 6115 (12-Bit Resolution).....	70
NI 6120 (16-Bit Resolution).....	73
NI 6122/6123 (16-Bit Resolution).....	75
NI PXIe-6124 (16-Bit Resolution).....	77
NI 6132/6133 (14-Bit Resolution).....	78
NI 6143 (16-Bit Resolution).....	80
X Series Test Limits	81
NI 6320/6321/6323 (16-Bit Resolution).....	81
NI 6341/6343 (16-Bit Resolution).....	83
NI 6345/6351/6353/6355 (16-Bit Resolution).....	84
NI 6346/6349 (16-Bit Resolution).....	87
NI 6356/6358/6366/6368/6374/6376/6378 (16-Bit Resolution)	88
NI 6361/6363/6365/6375 (16-Bit Resolution).....	91
NI 6386 (16-Bit Resolution).....	94
NI 6396 (18-Bit Resolution).....	96
Worldwide Support and Services	98

Software

Calibrating NI B/E/M/S/X Series DAQ devices requires the installation of NI-DAQmx on the calibration system. NI recommends using NI-DAQmx 19.1 or later. Refer to the *NI-DAQmx Readme* to ensure support for the device you want to calibrate. You can download NI-DAQmx from ni.com/downloads. NI-DAQmx supports many programming languages, including LabVIEW, LabWindows™/CVI™, C/C++, C#, and Visual Basic .NET. When you install NI-DAQmx, you only need to install support for the application software that you intend to use.

Documentation

Consult the following documents for information about your NI B/E/M/S/X Series DAQ device, NI-DAQmx, and your application software. All documents are available on ni.com, and help files install with the software.



Getting started guide for your DAQ device

The DAQ getting started guides for NI-DAQmx provides instructions for installing and configuring NI-DAQmx devices.



User manual for your DAQ device

The *NI 6010 Help*, *E Series User Manual*, *M Series User Manual*, *NI USB-621x User Manual*, *S Series User Manual*, *NI 6124/6154 User Manual*, or *X Series User Manual* provides information about your DAQ device.



NI 6xxx Specifications

The specifications document for your DAQ device provides detailed specifications, including the device calibration interval.



E Series Calibration Fixture Installation Guide

Provides information on installing and operating the E/M/S Series calibration hardware adapter.



NI-DAQmx Readme

Operating system and application software support in NI-DAQmx.



NI-DAQmx Help

Information about creating applications that use the NI-DAQmx driver.



LabVIEW Help

LabVIEW programming concepts and reference information about NI-DAQmx VIs and functions



NI-DAQmx C Reference Help

Reference information for NI-DAQmx C functions and NI-DAQmx C properties



NI-DAQmx .NET Help Support for Visual Studio

Reference information for NI-DAQmx .NET methods and NI-DAQmx .NET properties, key concepts, and a C enum to .NET enum mapping table

Password

The default password for password-protected operations is NI.

Test Equipment

Table 1 lists the equipment recommended for the performance verification and adjustment procedures. If the recommended equipment is not available, select a substitute using the requirements listed in Table 1.



Caution For compliance with Electromagnetic Compatibility (EMC) requirements, this product must be operated with shielded cables and accessories. If unshielded cables or accessories are used, the EMC specifications are no longer guaranteed unless all unshielded cables and/or accessories are installed in a shielded enclosure with properly designed and shielded input/output ports.

Table 1. Recommended Equipment

Equipment	Recommended Models	Where Used	Requirements
Calibrator	Fluke 5700A	<i>Analog Input Verification, Adjustment</i>	If this instrument is unavailable, use a high-precision voltage source that is at least 50 ppm (0.005%) accurate for 12-bit devices, and 10 ppm (0.001%) accurate for 14-, 16-, and 18-bit devices.
DMM	NI 4070	<i>Analog Output Verification</i>	If this instrument is unavailable, use a multiranging 6 1/2-digit DMM with an accuracy of 40 ppm.
Counter	Agilent 53220A	<i>Counter Verification</i>	Whether using the recommended instrument or another counter, you must ensure that it is configured to be <i>at least</i> 12.5 ppm (0.00125%) accurate.
PXI chassis	NI PXI-1042, NI PXI-1042Q	—	Use with PXI modules.
PXI Express chassis	NI PXIe-1062Q	—	Use with PXI Express modules.
Low thermal copper EMF plug-in cable	Fluke 5440A-7002	—	<i>Do not</i> use standard banana cables.

Table 1. Recommended Equipment (Continued)

Equipment	Recommended Models	Where Used	Requirements
Shielded DAQ cable	NI SH68-68-EP, NI SH68-68-EPM	—	Use with B/E/M/S Series devices with 68-pin SCSI II connectors.
	NI SHC68-68-EP, NI SHC68-68-EPM, NI SHC68-68	—	Use with E/M/S/X Series devices with 68-pin VHDCI connectors.
	NI SH1006868	—	Use with E Series devices with 100-pin connectors.*
	NI SH37F-37M-1	—	Use with B/M Series devices with 37-pin D-SUB connectors.
DAQ accessory	NI E/M/S Series calibration hardware adapter	—	<p>Connects your calibration equipment to your 68-pin E/M/S/X Series device.</p> <p>If you programmatically control this fixture, you do not need to disconnect and reconnect cables at each step of the procedure.†</p> <p>(NI 61xx Devices) S Series devices <i>must</i> use revision B or later of the calibration adapter.</p>
	NI SCB-68, NI SCB-68A, NI SCC-68	—	Shielded I/O connector block with 68 screw terminals for easy signal connection to 68- or 100-pin DAQ devices.
	NI CB-68LP, NI CB-68LPR, NI TBX-68	—	Low-cost termination accessories with 68 screw terminals for easy connection of field I/O signals to 68-pin DAQ devices.
	NI BNC-2110	—	Desktop and DIN rail-mountable BNC adapter you can connect to DAQ devices.
	NI CB-37F-LP	—	Low-cost termination accessory with 37 screw terminals for easy connection of field I/O signals to 37-pin DAQ devices.
<p>* Connect the 68-pin cable labeled MIO-16 to the accessory. The 68-pin cable labeled Extended I/O remains unconnected.</p> <p>† For M/S/X Series devices with two connectors, you do need to disconnect the calibration equipment from Connector 0 and reconnect to Connector 1 midway through the verification procedure.</p>			

Test Conditions

Follow these guidelines to optimize the connections and the environment during calibration.

- Keep connections to the device as short as possible. Long cables and wires can act as antennae, which could pick up extra noise that would affect measurements.
- Use shielded copper wire for all cable connections to the device. Use twisted-pair wire to eliminate noise and thermal offsets.
- Maintain the ambient temperature between 18 and 28 °C. The device temperature is greater than the ambient temperature. Refer to the [Calibration Procedure](#) section for more information about calibration temperatures and temperature drift.
- For valid test limits, maintain the device temperature within ± 1 °C from the last self-calibration and ± 10 °C from the last external calibration.
- Keep relative humidity below 80%.
- Allow adequate warm-up time (generally between 15 and 30 minutes for most DAQ devices) to ensure that the measurement circuitry is at a stable operating temperature. Refer to your DAQ device specifications document for the recommended warm-up time for your device.

Calibration Procedure

The calibration process has the following steps.

1. [Initial Setup](#)—Configure your device in NI-DAQmx, adjust the self-calibration constants of the device, and verify that the current device temperature does not cause you to incorrectly calibrate your device.
2. [Verification](#)—Verify the existing operation of the device. This step allows you to confirm that the device was operating within its specified range prior to calibration.
3. [Adjustment](#)—Perform an external calibration that adjusts the device calibration constants with respect to a known voltage source.
4. [EEPROM Update](#)—When an adjustment procedure is completed, the NI B/E/M/S/X Series device internal calibration memory (EEPROM) is immediately updated. If you do not want to perform an adjustment, you can update the calibration date without making any adjustments.
5. [Reverification](#)—Perform another verification to ensure that the device is operating within its specifications after adjustment.

These steps are described in detail in the following sections. Although NI recommends that you verify all ranges, you can save time by checking only the ranges used in your application.

Initial Setup

Refer to your device getting started guide for information about how to install the software and hardware and how to configure the device in Measurement & Automation Explorer (MAX).



Note When a device is configured in MAX, it is assigned a device name. Each function call uses this device name to determine which device to calibrate. This document uses `Dev_name` to refer to the device name. In the following procedures, use the device name as it appears in MAX.

1. Install the application software (if applicable).
2. Install the NI-DAQmx driver software.
3. Power off the host computer or chassis that contains the device and install the device.
4. Power on the computer or chassis and launch MAX.
5. Select **My System»Devices and Interfaces»*your device***.
6. Configure the device identifier and select **Self-Test** to ensure that the device is working properly.

Self-Calibration

Complete the following steps to self-calibrate the device.



Note (NI 6013/6014/6015/6016) NI 6013/6014/6015/6016 devices do not have a self-calibration option. For these devices, continue with the [Verification](#) section.



Note Disconnect all external signals before beginning self-calibration.



Note (NI 6346/49/56/58/66/68/76/78/86/96) Connect all inputs for SMIO devices to ground or to signals which do not exceed the input voltage range of the device. Overvoltages or floating inputs can cause self-calibration errors.

1. Wait for the device to warm-up for the recommended time period—generally between 15 and 30 minutes for most DAQ devices. Refer to your DAQ device specifications document for the recommended warm-up time for your device.
2. Launch MAX.
3. Select **My System»Devices and Interfaces»*your device***.
4. Click **Self-Calibrate**.

Checking Device Temperature Changes

Device temperature changes (greater than ± 10 °C since the previous external calibration or greater than ± 1 °C since the previous self-calibration) can cause you to incorrectly validate your device. After self-calibrating your device (as described in the [Self-Calibration](#) section), complete the following steps to compare the current device temperature to the temperatures measured during the last self-calibration and external calibration.



Note (NI 6010/6013/6014/6015/6016) B Series devices cannot compare device temperatures. For these devices, continue with the *Verification* section.

1. Read the current device temperature by using the DevTemp property node.

LabVIEW Block Diagram	NI-DAQmx Function Call
	<p>Call DAQmxGetCalDevTemp with the following parameter:</p> <p>deviceName: Dev_name</p>

2. Obtain the device temperature from the last self-calibration by using the SelfCal.LastTemp property node.

LabVIEW Block Diagram	NI-DAQmx Function Call
	<p>Call DAQmxGetSelfCalLastTemp with the following parameter:</p> <p>deviceName: Dev_name</p>

If the difference between the current temperature and the temperature from the last self-calibration is greater than 1 °C, the calibration limits for the devices that support self-calibration are not valid.

3. Obtain the temperature of the last external calibration by using the ExtCal.LastTemp property node.

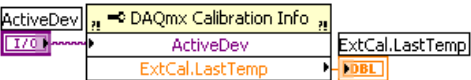
LabVIEW Block Diagram	NI-DAQmx Function Call
	<p>Call DAQmxGetExtCalLastTemp with the following parameter:</p> <p>deviceName: Dev_name</p>

If the difference between the current temperature and the temperature from the last external calibration is greater than 10 °C, the calibration limits are not valid.



Note The maximum temperature change for most DAQ devices is ± 10 °C. To find the valid temperature drifts for your E/M/S/X device, refer to the Absolute Accuracy table(s) in your DAQ device specifications document.



Note You also can read the current device temperature, the temperature during the last self-calibration, and the temperature during the last external calibration in MAX. Launch MAX, select **My System**»**Devices and Interfaces**»*your device*, and then click the **Calibration** tab.

If the device temperature is outside the maximum range, you should choose one of the following options:

- Change the test limits to include the additional error due to temperature drift. Refer to your DAQ device specifications document for more information.
- Change the system so that the temperature is closer to the temperature recorded during the last external calibration.

Verification

The following performance verification procedures describe the sequence of operation and provides test points required to verify the NI B/E/M/S/X Series DAQ device. The verification procedures assume that adequate traceable uncertainties are available for the calibration references.

The verification procedure is divided into the major functions of the device. Throughout the verification process, use the tables in the *Test Limits* section to determine if your device needs to be adjusted.

Analog Input Verification

Since B/E/M/S/X Series devices have many different ranges, you must check measurements for each available range.

(B/E/M/X Series [MIO] Devices) Because there is only one analog-to-digital converter (ADC) on B/E/M Series and X Series NI 632x/634x/6351/6353/6355/6361/6363/6365/6375 devices, you must perform verification on all ranges of one analog input channel in differential mode.

(Optional) Then, perform verification on one range of all remaining analog input channels in differential mode to verify that the device mux and analog input lines are operating properly.

(S/X Series [Simultaneous MIO] Devices) You must perform verification on all ranges of all analog input channels of S Series and X Series NI 6346/6349/6356/6358/6366/6368/6374/6376/6378/6386/6396 devices in differential mode.



Note Test limits in tables of the *Test Limits* section are based upon the most recent edition of the specifications document for your device. Refer to the most recent specifications document online at ni.com/manuals.

Complete the following steps to check the performance of the analog input.

1. Connect the calibrator to the device. Refer to Table 2 to determine connections between the device and the calibrator.



Note If your calibrator has a guard connection, connect that terminal to AI GND. If your calibrator does not have a guard connection and has a floating output, connect the negative output to AI GND. If the calibrator output is not floating, do not make any other connections. For more information, refer to the user documentation for the

device you are using. If you are using the E/M/S Series calibration hardware adapter, connect the device as described in the *E Series Calibration Fixture Installation Guide*.



Note (NI USB-6215/6216/6218 Devices) For isolated devices, if the calibrator outputs are truly floating, the negative output must be connected to a quiet earth ground as well as AI GND to give the entire system a ground reference.



Note Overvoltages or floating inputs can cause verification errors. Connect channels to ground before performing verification.

Table 2. Analog Input Connections

Device	Calibrator		
	Positive Output	Negative Output	Guard Connection
B/E/M/X Series (MIO)*	AI 0 (pin 68) [†]	AI 8 (pin 34) [†]	AI GND (pin 67) [†]
S/X Series (Simultaneous MIO) [‡] Connector 0	AI 0 + (pin 68)	AI 0 - (pin 34)	AI 0 GND (pin 67)
	AI 1 + (pin 33)	AI 1 - (pin 66)	AI 1 GND (pin 32)
	AI 2 + (pin 65)	AI 2 - (pin 31)	AI 2 GND (pin 64)
	AI 3 + (pin 30)	AI 3 - (pin 63)	AI 3 GND (pin 29)
	AI 4 + (pin 28)	AI 4 - (pin 61)	AI 4 GND (pin 27)
	AI 5 + (pin 60)	AI 5 - (pin 26)	AI 5 GND (pin 59)
	AI 6 + (pin 25)	AI 6 - (pin 58)	AI 6 GND (pin 24)
	AI 7 + (pin 57)	AI 7 - (pin 23)	AI 7 GND (pin 56)
X Series (Simultaneous MIO)** Connector 1	AI 8 + (pin 68)	AI 8 - (pin 34)	AI 8 GND (pin 67)
	AI 9 + (pin 33)	AI 9 - (pin 66)	AI 9 GND (pin 32)
	AI 10 + (pin 65)	AI 10 - (pin 31)	AI 10 GND (pin 64)
	AI 11 + (pin 30)	AI 11 - (pin 63)	AI 11 GND (pin 29)
	AI 12 + (pin 28)	AI 12 - (pin 61)	AI 12 GND (pin 27)
	AI 13 + (pin 60)	AI 13 - (pin 26)	AI 13 GND (pin 59)
	AI 14 + (pin 25)	AI 14 - (pin 58)	AI 14 GND (pin 24)
	AI 15 + (pin 57)	AI 15 - (pin 23)	AI 15 GND (pin 56)

Table 2. Analog Input Connections (Continued)

Device	Calibrator		
	Positive Output	Negative Output	Guard Connection
NI 6349	AI 8 + (pin 68)	AI 8 - (pin 34)	AI GND (pin 22)
	AI 9 + (pin 33)	AI 9 - (pin 67)	AI GND (pin 22)
	AI 10 + (pin 32)	AI 10 - (pin 66)	AI GND (pin 22)
	AI 11 + (pin 65)	AI 11 - (pin 31)	AI GND (pin 22)
	AI 12 + (pin 30)	AI 12 - (pin 64)	AI GND (pin 22)
	AI 13 + (pin 29)	AI 13 - (pin 63)	AI GND (pin 22)
	AI 14 + (pin 62)	AI 14 - (pin 28)	AI GND (pin 22)
	AI 15 + (pin 27)	AI 15 - (pin 61)	AI GND (pin 22)
	AI 16 + (pin 26)	AI 16 - (pin 60)	AI GND (pin 22)
	AI 17 + (pin 59)	AI 17 - (pin 25)	AI GND (pin 22)
	AI 18 + (pin 24)	AI 18 - (pin 58)	AI GND (pin 22)
	AI 19 + (pin 23)	AI 19 - (pin 57)	AI GND (pin 22)
	AI 20 + (pin 55)	AI 20 - (pin 21)	AI GND (pin 22)
	AI 21 + (pin 20)	AI 21 - (pin 54)	AI GND (pin 22)
	AI 22 + (pin 19)	AI 22 - (pin 53)	AI GND (pin 22)
	AI 23 + (pin 52)	AI 23 - (pin 18)	AI GND (pin 22)
	AI 24 + (pin 17)	AI 24 - (pin 51)	AI GND (pin 22)
	AI 25 + (pin 16)	AI 25 - (pin 50)	AI GND (pin 22)
	AI 26 + (pin 49)	AI 26 - (pin 15)	AI GND (pin 22)
	AI 27 + (pin 14)	AI 27 - (pin 48)	AI GND (pin 22)
AI 28 + (pin 13)	AI 28 - (pin 47)	AI GND (pin 22)	
AI 29 + (pin 46)	AI 29 - (pin 12)	AI GND (pin 22)	
AI 30 + (pin 11)	AI 30 - (pin 45)	AI GND (pin 22)	

Table 2. Analog Input Connections (Continued)

Device	Calibrator		
	Positive Output	Negative Output	Guard Connection
NI 6349	AI 31 + (pin 10)	AI 31 - (pin 44)	AI GND (pin 22)
<p>* NI 632x/634x/6351/6353/6355/6361/6363/6365/6375 X Series MIO devices.</p> <p>† You must perform verification on all ranges of one analog input channel in differential mode. (Optional) Then, perform verification on one range of all remaining analog input channels in differential mode to verify that the device mux and analog input lines are operating properly. Refer to your device user documentation for signal connection locations.</p> <p>‡ NI 6346/6349/6356/6358/6366/6368/6374/6376/6378/6386/6396 X Series simultaneous MIO devices.</p> <p>** NI 6358/6368/6378 X Series simultaneous MIO devices.</p>			

- Choose the table from the *Test Limits* section that corresponds with the device you are verifying. This table shows all acceptable settings for the device type. NI recommends that you verify all ranges, although you may want to save time by checking only the ranges used in your application.
- Set the calibrator voltage to the test value indicated in the device table.
- Create a task using `DAQmxCreateTask`.
- Add a channel to the task using the `DAQmx Create Virtual Channel VI` and configure the channel. Use the tables in the *Test Limits* section to determine the minimum and maximum values for your device.



Note Throughout the procedure, refer to the NI-DAQmx function call parameters for the LabVIEW input values.

LabVIEW Block Diagram	NI-DAQmx Function Call
	<p>Call <code>DAQmxCreateAIVoltageChan</code> with the following parameters:</p> <p>taskHandle: <code>taskHandle</code> physicalChannel: <code>Dev_name/ai0</code> nameToAssignToChannel: <code>myVoltageChannel</code> terminalConfig: <code>DAQmx_Val_Cfg_Default</code> minVal: <code>-10.0</code> maxVal: <code>10.0</code> units: <code>DAQmx_Val_Volts</code> customScaleName: <code>NULL</code></p>

6. **(NI 628x Devices)** Configure the lowpass filter by setting the AI.Lowpass.Enable property node to True.

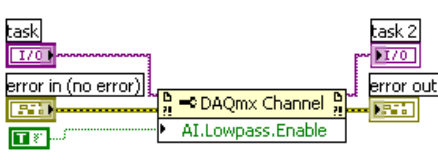
LabVIEW Block Diagram	NI-DAQmx Function Call
 <p>The diagram shows a task handle connected to a DAQmx Channel block. A Boolean control 'AI.Lowpass.Enable' is connected to the channel's 'AI.Lowpass.Enable' property node. The channel's output is connected to a task 2 handle.</p>	<p>Call <code>DAQmxSetChanAttribute</code> with the following parameters:</p> <p>taskHandle: taskHandle Channel: "" Attribute: <code>DAQmx_AI_Lowpass_Enable</code> Value: 0 (filter off) or 1 (filter on)</p>

7. Configure timing for the voltage acquisition using the DAQmx Timing VI. Use 10000.0 for **rate** and 10000 for **sampsPerChan**.

(NI 6011E [PCI-MIO-16XE-50] and NI 6115/6120 Devices) Use 20000.0 for **rate** and 20000 for **sampsPerChan**.

(NI 6386/6396 Devices) Use 20000.0 for **rate** and 10000 for **sampsPerChan**.

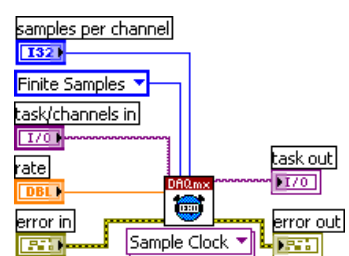
LabVIEW Block Diagram	NI-DAQmx Function Call
 <p>The diagram shows a DAQmx Timing VI block. It receives inputs for 'samples per channel' (132), 'Finite Samples' (dropdown), 'task/channels in', 'rate' (20000.0), and 'error in'. The 'Sample Clock' dropdown is also connected. The output of the timing block is connected to the DAQmx Channel block.</p>	<p>Call <code>DAQmxCfgSampClkTiming</code> with the following parameters:</p> <p>taskHandle: taskHandle source: NULL rate: 10000.0 or 20000.0 activeEdge: <code>DAQmx_Val_Rising</code> sampleMode: <code>DAQmx_Val_FiniteSamps</code> sampsPerChan: 10000 or 20000</p>

8. **(NI 6023E/6024E/6025E/6040E/6062E Devices)** For 12-bit E Series devices, configure dither to be on by setting the AI.Dither.Enable property node to True.

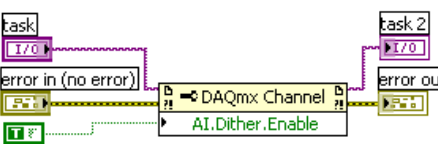
LabVIEW Block Diagram	NI-DAQmx Function Call
 <p>The diagram shows a task handle connected to a DAQmx Channel block. A Boolean control 'AI.Dither.Enable' is connected to the channel's 'AI.Dither.Enable' property node. The channel's output is connected to a task 2 handle.</p>	<p>Call <code>DAQmxSetAIDitherEnable</code> with the following parameters:</p> <p>taskHandle: taskHandle channel []: <code>MyVoltageChannel</code> bool32: TRUE</p>

- Start the acquisition using the DAQmx Start Task VI.

LabVIEW Block Diagram	NI-DAQmx Function Call
 <p>The diagram shows a DAQmx Start Task VI block. It has two input terminals: 'task/channels in' and 'error in'. The 'task/channels in' terminal is connected to a 'task out' terminal. The 'error in' terminal is connected to an 'error out' terminal. The DAQmx Start Task VI block is connected to a 'task out' terminal and an 'error out' terminal.</p>	<p>Call DAQmxStartTask with the following parameter:</p> <p>taskHandle: taskHandle</p>

- Acquire 10,000 points of voltage data using the DAQmx Read VI.
(NI 6011E [PCI-MIO-16XE-50], NI 6115/6120 Devices, and NI 6386/6396 Devices)
 Acquire 20,000 points of voltage data using the DAQmx Read VI.

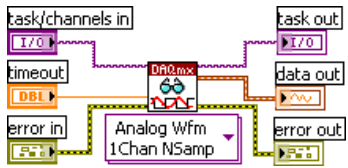
LabVIEW Block Diagram	NI-DAQmx Function Call
 <p>The diagram shows a DAQmx Read VI block. It has four input terminals: 'task/channels in', 'timeout', 'error in', and 'data out'. The 'task/channels in' terminal is connected to a 'task out' terminal. The 'timeout' terminal is connected to a 'data out' terminal. The 'error in' terminal is connected to an 'error out' terminal. The DAQmx Read VI block is connected to a 'task out' terminal, a 'data out' terminal, and an 'error out' terminal. The DAQmx Read VI block is set to 'Analog Wfm 1Chan N5amp'.</p>	<p>Call DAQmxReadAnalogF64 with the following parameters:</p> <p>taskHandle: taskHandle numSampsPerChan: -1 timeout: 10.0 fillMode: DAQmx_Val_GroupByChannel readArray: data arraySizeInSamples: 10000 or 20000 sampsPerChanRead: &read reserved: NULL</p>

- Average the voltage values that you acquired. Compare the resulting average to the upper and lower limits listed in the table in the *Test Limits* section. If the result is between these values, the device passes the test.
- Clear the acquisition using the DAQmx Clear Task VI.

LabVIEW Block Diagram	NI-DAQmx Function Call
 <p>The diagram shows a DAQmx Clear Task VI block. It has two input terminals: 'task in' and 'error in'. The 'task in' terminal is connected to a 'task out' terminal. The 'error in' terminal is connected to an 'error out' terminal. The DAQmx Clear Task VI block is connected to a 'task out' terminal and an 'error out' terminal.</p>	<p>Call DAQmxClearTask with the following parameter:</p> <p>taskHandle: taskHandle</p>

13. **(B/E/M/X Series [MIO] Devices)** Repeat steps 4 through 12 until all values have been verified on NI 601x/60xxE/62xx/632x/634x/6351/6353/6355/6361/6363/6365/6375 devices.

(S/X Series [Simultaneous MIO] Devices) Repeat steps 4 through 12 for all channels and all values on NI 61xx/6346/6349/6356/6358/6366/6368/6374/6376/6378/6386/6396 devices.

14. Disconnect the calibrator from the device.

You have finished verifying the analog input levels on your device.

Analog Output Verification

Most B/E/M/S/X Series devices have two analog outputs, AO 0 and AO 1. Some M/X Series devices have four analog outputs, two on each connector. Skip this step if the device you are calibrating does not have analog output circuitry.



Note Test limits in tables of the *Test Limits* section are based upon the most recent edition of the specifications document for your device. Refer to the most recent specifications document online at ni.com/manuals.



Note The test limits used in this document assume a maximum temperature drift of ± 10 °C from the last external calibration, and a maximum temperature drift of ± 1 °C from the last self-calibration. Refer to the *Calibration Procedure* section for more information and instructions on reading your device temperature and comparing it against the device temperature during the last external calibration.



Note When making 0 V measurements, you must keep the NI 4070 in the ± 10 V range to avoid having to take null measurements in the ± 100 mV range.

Complete the following steps to check analog output measurements.

1. Connect your DMM to AO 0 as shown in Table 3.



Note (NI USB-6215/6216/6218 Devices) For isolated devices, you must also connect AO GND to a quiet earth ground reference or the ground reference of the DMM.

Table 3. Analog Output Connections

Analog Output	DMM	
	Positive Input*	Negative Input*
AO 0	Connector 0, AO 0 (pin 22)	Connector 0, AO GND (pin 55)
AO 1	Connector 0, AO 1 (pin 21)	Connector 0, AO GND (pin 55)

Table 3. Analog Output Connections

Analog Output	DMM	
	Positive Input*	Negative Input*
AO 2	Connector 1, AO 2 (pin 22)	Connector 1, AO GND (pin 55)
AO 3	Connector 1, AO 3 (pin 21)	Connector 1, AO GND (pin 55)

* Pin numbers are given for 68-pin connectors only. If you are using a BNC, DAQPad/USB screw terminal, 34-pin IDC header, 50-pin IDC header, 37-pin, or 100-pin connector, refer to your device user documentation for signal connection locations.

- Choose the table from the *Test Limits* section that corresponds with the device you are verifying. This table shows all acceptable settings for the device. NI recommends that you verify all ranges, although you may want to save time by checking only the ranges used in your application.
- Create a task using `DAQmxCreateTask`.

LabVIEW Block Diagram	NI-DAQmx Function Call
LabVIEW does not require this step.	Call <code>DAQmxCreateTask</code> with the following parameters: taskName: <code>MyAOVoltageTask</code> taskHandle: <code>&taskHandle</code>

- Add an AO voltage task using the `DAQmx Create Virtual Channel VI` and configure the channel, AO 0. Use the tables in the *Test Limits* section to determine the minimum and maximum values for your device.



Note Throughout the procedure, refer to the NI-DAQmx function call parameters for the LabVIEW input values.

LabVIEW Block Diagram	NI-DAQmx Function Call
	Call <code>DAQmxCreateAOVoltageChan</code> with the following parameters: taskHandle: <code>taskHandle</code> physicalChannel: <code>Dev_name/ao0</code> nameToAssignToChannel: <code>AOVoltageChannel</code> minVal: <code>-10.0</code> maxVal: <code>10.0</code> units: <code>DAQmx_Val_Volts</code> customScaleName: <code>NULL</code>

5. Start the generation using the DAQmx Start Task VI.

LabVIEW Block Diagram	NI-DAQmx Function Call
 <p>The diagram shows a 'task/channels in' control with an 'I/O' indicator. A 'DAQmx Start Task VI' is connected to 'task out' and 'error out' indicators. An 'error in' control is also present.</p>	<p>Call DAQmxStartTask with the following parameter:</p> <p>taskHandle: taskHandle</p>

6. Write a voltage (from the Test Point column of the table in the *Test Limits* section) to the AO channel using the DAQmx Write VI.

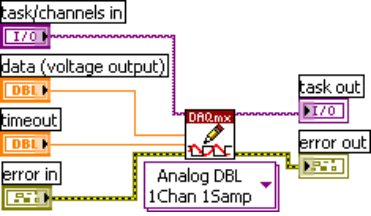
LabVIEW Block Diagram	NI-DAQmx Function Call
 <p>The diagram shows a 'task/channels in' control with an 'I/O' indicator. A 'data (voltage output)' control is connected to a 'DAQmx Write Analog F64 VI'. The VI is also connected to 'task out' and 'error out' indicators. A 'timeout' control is connected to the VI. An 'Analog DBL 1Chan 15amp' control is connected to the VI. An 'error in' control is also present.</p>	<p>Call DAQmxWriteAnalogF64 with the following parameters:</p> <p>taskHandle: taskHandle numSampsPerChan: 1 autoStart: 1 timeout: 10.0 dataLayout: DAQmx_Val_GroupByChannel writeArray: &data sampsPerChanWritten: &samplesWritten reserved: NULL</p>

7. Compare the resulting value shown by the DMM to the upper and lower limits in the table in the *Test Limits* section. If the value is between these limits, the device passes the test.
8. Repeat steps 6 and 7 until all of the Test Point values in the table in the *Test Limits* section have been tested.
9. Clear the acquisition using the DAQmx Clear Task VI.

LabVIEW Block Diagram	NI-DAQmx Function Call
 <p>The diagram shows a 'task in' control with an 'I/O' indicator. A 'DAQmx Clear Task VI' is connected to 'error in' and 'error out' indicators.</p>	<p>Call DAQmxClearTask with the following parameter:</p> <p>taskHandle: taskHandle</p>

10. Disconnect the DMM from AO 0, and reconnect it to AO 1, making the connections shown in Table 3.
11. Repeat steps 3 through 10 for all AO channels on the device.
12. Disconnect your DMM from the device.

You have finished verifying the analog output levels on your device.

Counter Verification

B/E/M/S/X Series devices have only one timebase to verify, so only Counter 0 needs to be checked. It is not possible to adjust this timebase, so only verification can be performed.



Note Test limits in tables of the *Test Limits* section are based upon the most recent edition of the specifications document for your device. Refer to the most recent specifications document online at ni.com/manuals.



Note The test limits used in this document assume a maximum temperature drift of $\pm 10\text{ }^{\circ}\text{C}$ from the last external calibration, and a maximum temperature drift of $\pm 1\text{ }^{\circ}\text{C}$ from the last self-calibration. Refer to the *Calibration Procedure* section for more information and instructions on reading your device temperature and comparing it against the device temperature during the last external calibration.

Complete the following steps to perform checks on the counter of your device.

1. Connect your counter positive input to CTR 0 OUT (pin 2) and your counter negative input to D GND (pin 35).¹
2. Create a task using DAQmxCreateTask.
3. Add a counter output channel to the task using the DAQmx Create Virtual Channel VI and configure the channel.



Note Throughout the procedure, refer to the NI-DAQmx function call parameters for the LabVIEW input values.

LabVIEW Block Diagram	NI-DAQmx Function Call
	<p>Call DAQmxCreateCOPulseChanFreq with the following parameters:</p> <p>taskHandle: taskHandle counter: Dev_name/ctr0 nameToAssignToChannel: CounterOutputChannel units: DAQmx_Val_Hz idleState: DAQmx_Val_Low initialDelay: 0.0 freq: 5000000.0 dutyCycle: 0.5</p>

4. Configure the counter on the DAQ device for continuous square wave generation using the DAQmx Timing VI.

¹ Pin numbers are given for 68-pin connectors only. If you are using a BNC, DAQPad/USB screw terminal, 34-pin IDC header, 50-pin IDC header, 37-pin, or 100-pin connector, refer to your device user documentation for signal connection locations.

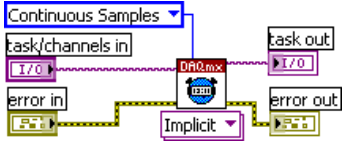
LabVIEW Block Diagram	NI-DAQmx Function Call
 <p>The diagram shows a DAQmx configuration block with a dropdown menu set to 'Implicit'. It has inputs for 'task/channels in', 'I/O', and 'error in', and outputs for 'task out', 'I/O', and 'error out'. A 'Start Task VI' icon is connected to the 'Implicit' dropdown.</p>	<p>Call <code>DAQmxCfgImplicitTiming</code> with the following parameters:</p> <p>taskHandle: taskHandle sampleMode: DAQmx_Val_ContSamps sampsPerChan: 10000</p>

5. Start the generation of a square wave using the DAQmx Start Task VI.

LabVIEW Block Diagram	NI-DAQmx Function Call
 <p>The diagram shows a DAQmx block with a dropdown menu set to a square wave icon. It has inputs for 'task/channels in', 'I/O', and 'error in', and outputs for 'task out', 'I/O', and 'error out'. A 'Start Task VI' icon is connected to the DAQmx block.</p>	<p>Call <code>DAQmxStartTask</code> with the following parameter:</p> <p>taskHandle: taskHandle</p>

The DAQ device generates a 5 MHz square wave.

6. Configure the external counter to measure frequency and use a 1 M Ω impedance.
7. Take a measurement of the square wave using the external counter.
8. Compare the value read by your counter to the test limits shown on the device table in the [Test Limits](#) section. If the value falls between these limits, the device passes the test.
9. Stop the generation using the DAQmx Stop Task VI.

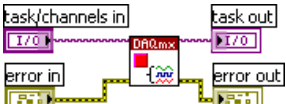
LabVIEW Block Diagram	NI-DAQmx Function Call
 <p>The diagram shows a DAQmx block with a dropdown menu set to a square wave icon. It has inputs for 'task/channels in', 'I/O', and 'error in', and outputs for 'task out', 'I/O', and 'error out'. A 'Stop Task VI' icon is connected to the DAQmx block.</p>	<p>Call <code>DAQmxStopTask</code> with the following parameter:</p> <p>taskHandle: taskHandle</p>

10. Clear the generation using the DAQmx Clear Task VI.

LabVIEW Block Diagram	NI-DAQmx Function Call
 <p>The diagram shows a DAQmx block with a dropdown menu set to a square wave icon. It has inputs for 'task in', 'I/O', and 'error in', and an output for 'error out'. A 'Clear Task VI' icon is connected to the DAQmx block.</p>	<p>Call <code>DAQmxClearTask</code> with the following parameter:</p> <p>taskHandle: taskHandle</p>

11. Disconnect the external counter from your device.

Adjustment

The following procedure adjusts the both the analog input and analog output of your NI B/E/M/S/X Series device.

At the end of each calibration procedure, these new constants are stored in the external calibration area of the EEPROM. These values are password-protected, which prevents the accidental access or modification of any calibration constants adjusted by the metrology laboratory. The default password is NI.

Complete the following steps to perform device analog adjustment with a calibrator:

1. Connect the calibrator to the device. Refer to Table 4 to determine connections between the device and the calibrator. The calibrator connections depend on the resolution of the device you are calibrating.



Note If you are using the E/M/S Series calibration hardware adapter, connect the device as described in the *E Series Calibration Fixture Installation Guide*.

Table 4. Calibrator Connections

Device	Calibrator			Additional Connections
	Positive Output [†]	Negative Output [†]	Guard Connection [†]	
12-Bit E Series	AI 8 (pin 34)	AI SENSE (pin 62) [†]	AI GND (pin 67) [†]	Connect AO 0 (pin 22) line to AI 0 (pin 68)
16-Bit E Series, M/X Series (MIO) [‡]	AI 0 (pin 68)	AI 8 (pin 34) [†]	AI GND (pin 67) [†]	—
S/X Series (Simultaneous MIO)**	AI 0 + (pin 68)	AI 0 - (pin 34) [†]	AI 0 GND (pin 67) [†]	—
<p>* Pin numbers are given for 68-pin connectors only. If you are using a BNC, DAQPad/USB screw terminal, 34-pin IDC header, 50-pin IDC header, 37-pin, or 100-pin connector, refer to your device user documentation for signal connection locations.</p> <p>[†] If your calibrator does not have a guard connection and has a floating output, connect the negative output to AI GND. If the calibrator output is not floating, do not make any other connections. For more information, refer to your DAQ device user documentation.</p> <p>[‡] NI 632x/634x/6351/6353/6355/6361/6363/6365/6375 X Series MIO devices.</p> <p>** NI 6346/6349/6356/6358/6366/6368/6374/6376/6378/6386/6396 X Series simultaneous MIO devices.</p>				

- Set your calibrator to output the correct voltage for your device, as listed in the following table.

Device	Calibrator Output Voltage
NI 6010	3.750000 V
NI 6115/6120	5.000000 V
NI 6143	4.500000 V
All other devices	7.500000 V

- Open a calibration session on your device using the DAQmx Initialize External Calibration VI. The default password is NI.



Note Throughout the procedure, refer to the NI-DAQmx function call parameters for the LabVIEW input values.

LabVIEW Block Diagram	NI-DAQmx Function Call
<p>The LabVIEW block diagram shows a DAQmx Init Ext Cal block. It has three input terminals: 'device in' (containing '170'), 'password' (containing 'abc'), and 'calhandle out' (containing 'U32'). The block has two output terminals: 'error out' and 'calhandle out' (containing 'U32').</p>	<p>Call <code>DAQmxInitExtCal</code> with the following parameters:</p> <p>deviceName: Dev_name password: NI calHandle: &calHandle</p>

- Perform an external calibration adjustment using the DAQmx Adjust Y-Series Calibration VI, where *Y* is the letter of the device series.



Note (NI 6010 Devices) Use the DAQmx Adjust M-Series Calibration VI (`DAQmxMSeriesCalAdjust`).



Note (NI 6013/6014/6015/6016 Devices) Use the DAQmx Adjust E-Series Calibration VI (`DAQmxESeriesCalAdjust`).

LabVIEW Block Diagram	NI-DAQmx Function Call
<p>The LabVIEW block diagram shows a DAQmx Y Series Cal Adjust block. It has four input terminals: 'calhandle in' (containing 'U32'), 'reference voltage' (containing 'DB1'), 'error in' (containing 'E+'), and 'calhandle out' (containing 'U32'). The block has two output terminals: 'error out' and 'calhandle out' (containing 'U32').</p>	<p>Call <code>DAQmxYSeriesCalAdjust</code> with the following parameters:</p> <p>calHandle: calHandle referenceVoltage: 7.5, 3.75, 5, or 4.5 (based on calibrator output from step 2)</p>



Note The **referenceVoltage** value for `DAQmxYSeriesCalAdjust` must match the exact voltage applied to the device by the calibrator source.

- Save the adjustment to the EEPROM, using the DAQmx Close External Calibration VI. This VI also saves the date, time, and temperature of the adjustment to the onboard memory.

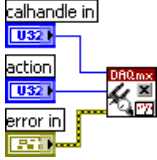

Note If an error occurs during adjustment, no constants is written to the EEPROM.

LabVIEW Block Diagram	NI-DAQmx Function Call
	<p>Call <code>DAQmxCloseExtCal</code> with the following parameters:</p> <p>calHandle: <code>calHandle</code></p> <p>action: <code>DAQmx_Val_Action_Commit</code></p>

- Disconnect the calibrator from the device.

EEPROM Update

When an adjustment procedure is completed, the NI B/E/M/S/X Series device internal calibration memory (EEPROM) is immediately updated.

If you do not want to perform an adjustment, you can update the calibration date without making any adjustments by initializing an external calibration (using the DAQmx Initialize External Calibration VI) and closing the external calibration (using the DAQmx Close External Calibration VI).

Reverification

Repeat the *Verification* section to determine the as-left status of the device.



Note If any test fails reverification after performing an adjustment, verify that you successfully self-calibrated the device, as described in the *Self-Calibration* section, before returning your device to NI. Refer to *Worldwide Support and Services* for assistance in returning the device to NI.

Test Limits

The tables in this section list the specifications for B/E/M/S/X Series devices. The specifications are divided into analog input, analog output, and counter/timer tables of values. Note that different devices have different calibration intervals. Refer to the tables and specifications document for your device.

B Series Test Limits

NI 6010 (16-Bit Resolution)

Tables 5 through 7 include values for the PCI-6010.

Table 5. NI 6010 Analog Input Values

Range (V)		Test Point		24-Hour Limits		1-Year Limits	
Minimum	Maximum	Location	Value (V)	Lower Limit (V)	Upper Limit (V)	Lower Limit (V)	Upper Limit (V)
-5	5	Pos FS	4.990000	4.986551	4.993449	4.984929	4.995071
-5	5	0.000000	0.000000	-0.002327	0.002327	-0.002327	0.002327
-5	5	Neg FS	-4.990000	-4.993449	-4.986551	-4.995071	-4.984929
-1	1	Pos FS	0.998000	0.997214	0.998786	0.996889	0.999111
-1	1	0.000000	0.000000	-0.000508	0.000508	-0.000508	0.000508
-1	1	Neg FS	-0.998000	-0.998786	-0.997214	-0.999111	-0.996889
-0.2	0.2	Pos FS	0.199600	0.199382	0.199818	0.199317	0.199883
-0.2	0.2	0.000000	0.000000	-0.000156	0.000156	-0.000156	0.000156
-0.2	0.2	Neg FS	-0.199600	-0.199818	-0.199382	-0.199883	-0.199317

Table 6. NI 6010 Analog Output Values

Range (V)		Test Point		24-Hour Limits		1-Year Limits	
Minimum	Maximum	Location	Value (V)	Lower Limit (V)	Upper Limit (V)	Lower Limit (V)	Upper Limit (V)
-5	5	Pos FS	4.990000	4.986244	4.993756	4.984623	4.995377
-5	5	0.000000	0.000000	-0.001615	0.001615	-0.001615	0.001615
-5	5	Neg FS	-4.990000	-4.993756	-4.986244	-4.995377	-4.984623

Table 7. NI 6010 Counter Values

Set Point (MHz)	Lower Limit (MHz)	Upper Limit (MHz)
5	4.99975	5.00025

NI 6013/6014/6015/6016 (16-Bit Resolution)

Tables 8 through 10 include values for the PCI-6013 (analog input only), PCI-6014, DAQPad-6015, and DAQPad-6016.

Table 8. NI 6013/6014/6015/6016 Analog Input Values

Range (V)		Test Point		24-Hour Limits		1-Year Limits	
Minimum	Maximum	Location	Value (V)	Lower Limit (V)	Upper Limit (V)	Lower Limit (V)	Upper Limit (V)
-10	10	Pos FS	9.8	9.791572	9.808428	9.791160	9.808840
-10	10	0	0	-0.001980	0.001980	-0.001980	0.001980
-10	10	Neg FS	-9.8	-9.808428	-9.791572	-9.808840	-9.791160

Table 8. NI 6013/6014/6015/6016 Analog Input Values (Continued)

Range (V)		Test Point		24-Hour Limits		1-Year Limits	
Minimum	Maximum	Location	Value (V)	Lower Limit (V)	Upper Limit (V)	Lower Limit (V)	Upper Limit (V)
-5	5	Pos FS	4.9	4.898225	4.901776	4.898019	4.901981
-5	5	0	0	-0.001001	0.001001	-0.001001	0.001001
-5	5	Neg FS	-4.9	-4.901776	-4.898225	-4.901981	-4.898019
-0.5	0.5	Pos FS	0.49	0.489557	0.490443	0.489536	0.490464
-0.5	0.5	0	0	-0.000121	0.000121	-0.000121	0.000121
-0.5	0.5	Neg FS	-0.49	-0.490443	-0.489557	-0.490464	-0.489536
-0.05	0.05	Pos FS	0.049	0.048933	0.049067	0.048931	0.049069
-0.05	0.05	0	0	-0.000034	0.000034	-0.000034	0.000034
-0.05	0.05	Neg FS	-0.049	-0.049067	-0.048933	-0.049069	-0.048931

Table 9. NI 6014/6015/6016 Analog Output Values

Range (V)		Test Point		24-Hour Limits		1-Year Limits	
Minimum	Maximum	Location	Value (V)	Lower Limit (V)	Upper Limit (V)	Lower Limit (V)	Upper Limit (V)
-10	10	Pos FS	9.8	9.795069	9.804931	9.794236	9.805764
-10	10	0	0	-0.002461	0.002461	-0.002461	0.002461
-10	10	Neg FS	-9.8	-9.804931	-9.795069	-9.805764	-9.794236

Table 10. NI 6013/6014/6015/6016 Counter Values

Set Point (MHz)	Lower Limit (MHz)	Upper Limit (MHz)
5	4.99950	5.00050

E Series Test Limits

NI 6011E (16-Bit Resolution)

Tables 11 through 13 include values for the NI 6011E (PCI-MIO-16XE-50).

Table 11. NI 6011E Analog Input Values

Range (V)		Test Point		24-Hour Limits		1-Year Limits	
Minimum	Maximum	Location	Value (V)	Lower Limit (V)	Upper Limit (V)	Lower Limit (V)	Upper Limit (V)
-10	10	Pos FS	9.98	9.978978	9.981022	9.978559	9.981441
-10	10	0	0	-0.000443	0.000443	-0.000443	0.000443
-10	10	Neg FS	-9.98	-9.981022	-9.978978	-9.981441	-9.978559
-5	5	Pos FS	4.99	4.988739	4.991261	4.988529	4.991471
-5	5	0	0	-0.000224	0.000224	-0.000224	0.000224
-5	5	Neg FS	-4.99	-4.991261	-4.988739	-4.991471	-4.988529
-1	1	Pos FS	0.998	0.997745	0.998255	0.997703	0.998297
-1	1	0	0	-0.000048	0.000048	-0.000048	0.000048
-1	1	Neg FS	-0.998	-0.998255	-0.997745	-0.998297	-0.997703
-0.1	0.1	Pos FS	0.0998	0.099751	0.099849	0.099746	0.099854
-0.1	0.1	0	0	-0.000009	0.000009	-0.000009	0.000009
-0.1	0.1	Neg FS	-0.0998	-0.099849	-0.099751	-0.099854	-0.099746
0	10	Pos FS	9.98	9.979154	9.980846	9.978735	9.981266

Table 11. NI 6011E Analog Input Values (Continued)

Range (V)		Test Point		24-Hour Limits		1-Year Limits	
Minimum	Maximum	Location	Value (V)	Lower Limit (V)	Upper Limit (V)	Lower Limit (V)	Upper Limit (V)
0	10	0	0.02	0.019731	0.020269	0.019731	0.020270
0	5	Pos FS	4.99	4.988826	4.991174	4.988617	4.991383
0	5	0	0.01	0.009862	0.010138	0.009862	0.010138
0	1	Pos FS	0.998	0.997762	0.998238	0.997720	0.998280
0	1	0	0.002	0.001969	0.002031	0.001969	0.002031
0	0.1	Pos FS	0.0998	0.099752	0.099848	0.099748	0.099852
0	0.1	0	0.0002	0.000193	0.000207	0.000193	0.000207

Table 12. NI 6011E Analog Output Values

Range (V)		Test Point		24-Hour Limits		1-Year Limits	
Minimum	Maximum	Location	Value (V)	Lower Limit (V)	Upper Limit (V)	Lower Limit (V)	Upper Limit (V)
-10	10	Pos FS	9.9800000	9.973195	9.986805	9.972796	9.987204
-10	10	0	0.0000000	-0.005408	0.005408	-0.005408	0.005408
-10	10	Neg FS	-9.9800000	-9.986805	-9.973195	-9.987204	-9.972796
0	10	Pos FS	9.9800000	9.975637	9.984363	9.975238	9.984762
0	10	0	0.0200000	0.017031	0.022969	0.017030	0.022970

Table 13. NI 6011E Counter Values

Set Point (MHz)	Lower Limit (MHz)	Upper Limit (MHz)
5	4.99950	5.00050

NI 6023E/6024E/6025E (12-Bit Resolution)

Tables 14 through 16 include values for the PCI-6023E (analog input only), PCI-6024E, PCI-6025E, and PXI-6025E.

Table 14. NI 6023E/6024E/6025E Analog Input Values

Range (V)		Test Point		24-Hour Limits		1-Year Limits	
Minimum	Maximum	Location	Value (V)	Lower Limit (V)	Upper Limit (V)	Lower Limit (V)	Upper Limit (V)
-10	10	Pos FS	9.800	9.7841	9.8159	9.7837	9.8163
-10	10	0	0.000	-0.0074	0.0074	-0.0074	0.0074
-10	10	Neg FS	-9.800	-9.8159	-9.7841	-9.8163	-9.7837
-5	5	Pos FS	4.900	4.8950	4.9050	4.8948	4.9052
-5	5	0	0.000	-0.0037	0.0037	-0.0037	0.0037
-5	5	Neg FS	-4.900	-4.9050	-4.8950	-4.9052	-4.8948
-0.5	0.5	Pos FS	0.490	0.48918	0.49082	0.48916	0.49084
-0.5	0.5	0	0.000	-0.00039	0.00039	-0.00039	0.00039
-0.5	0.5	Neg FS	-0.490	-0.49082	-0.48918	-0.49084	-0.48916
-0.05	0.05	Pos FS	0.049	0.048897	0.049103	0.048895	0.049105
-0.05	0.05	0	0.000	-0.000060	0.000060	-0.000060	0.000060
-0.05	0.05	Neg FS	-0.049	-0.049103	-0.048897	-0.049105	-0.048895

Table 15. NI 6024E/6025E Analog Output Values

Range (V)		Test Point		24-Hour Limits		1-Year Limits	
Minimum	Maximum	Location	Value (V)	Lower Limit (V)	Upper Limit (V)	Lower Limit (V)	Upper Limit (V)
-10	10	Pos FS	9.800000	9.792335	9.807665	9.791924	9.808076
-10	10	0	0.0000000	-0.005930	0.005930	-0.005930	0.005930
-10	10	Neg FS	-9.800000	-9.807665	-9.792335	-9.808076	-9.791924

Table 16. NI 6023E/6024E/6025E Counter Values

Set Point (MHz)	Lower Limit (MHz)	Upper Limit (MHz)
5	4.99950	5.00050

NI DAQCard-6024E (12-Bit Resolution)

Tables 17 through 19 include values for the DAQCard-6024E.

Table 17. NI DAQCard-6024E Analog Input Values

Range (V)		Test Point		24-Hour Limits		1-Year Limits	
Minimum	Maximum	Location	Value (V)	Lower Limit (V)	Upper Limit (V)	Lower Limit (V)	Upper Limit (V)
-10	10	Pos FS	9.800	9.7816	9.8184	9.7812	9.8188
-10	10	0	0.000	-0.0099	0.0099	-0.0099	0.0099
-10	10	Neg FS	-9.800	-9.8184	-9.7816	-9.8188	-9.7812
-5	5	Pos FS	4.900	4.8937	4.9063	4.8935	4.9065
-5	5	0	0.000	-0.0049	0.0049	-0.0049	0.0049
-5	5	Neg FS	-4.900	-4.9063	-4.8937	-4.9065	-4.8935
-0.5	0.5	Pos FS	0.490	0.48906	0.49094	0.48904	0.49096
-0.5	0.5	0	0.000	-0.00051	0.00051	-0.00051	0.00051
-0.5	0.5	Neg FS	-0.490	-0.49094	-0.48906	-0.49096	-0.48904
-0.05	0.05	Pos FS	0.049	0.048884	0.049116	0.048882	0.049118
-0.05	0.05	0	0.000	-0.000073	0.000073	-0.000073	0.000073
-0.05	0.05	Neg FS	-0.049	-0.049116	-0.048884	-0.049118	-0.048882

Table 18. NI DAQCard-6024E Analog Output Values

Range (V)		Test Point		24-Hour Limits		1-Year Limits	
Minimum	Maximum	Location	Value (V)	Lower Limit (V)	Upper Limit (V)	Lower Limit (V)	Upper Limit (V)
-10	10	Pos FS	9.8000000	9.789895	9.810105	9.789484	9.810516
-10	10	0	0.0000000	-0.008370	0.008370	-0.008370	0.008370
-10	10	Neg FS	-9.8000000	-9.810105	-9.789895	-9.810516	-9.789484

Table 19. NI DAQCard-6024E Counter Values

Set Point (MHz)	Lower Limit (MHz)	Upper Limit (MHz)
5	4.99950	5.00050

NI 6030E/6031E/6032E/6033E (16-Bit Resolution)

Tables 20 through 22 include values for the PCI-6030E (PCI-MIO-16XE-10), PXI-6030E, PCI-6031E, PXI-6031E, PCI-6032E, and PCI-6033E.

Table 20. NI 6030E/6031E/6032E/6033E Analog Input Values

Range (V)		Test Point		24-Hour Limits		1-Year Limits	
Minimum	Maximum	Location	Value (V)	Lower Limit (V)	Upper Limit (V)	Lower Limit (V)	Upper Limit (V)
-10	10	Pos FS	9.98	9.979027	9.980973	9.978857	9.981143
-10	10	0	0	-0.000534	0.000534	-0.000534	0.000534
-10	10	Neg FS	-9.98	-9.980973	-9.979027	-9.981143	-9.978857

Table 20. NI 6030E/6031E/6032E/6033E Analog Input Values (Continued)

Range (V)		Test Point		24-Hour Limits		1-Year Limits	
Minimum	Maximum	Location	Value (V)	Lower Limit (V)	Upper Limit (V)	Lower Limit (V)	Upper Limit (V)
-5	5	Pos FS	4.99	4.988012	4.991988	4.987928	4.992072
-5	5	0	0	-0.000271	0.000271	-0.000271	0.000271
-5	5	Neg FS	-4.99	-4.991988	-4.988012	-4.992072	-4.987928
-2	2	Pos FS	1.996	1.995200	1.996800	1.995166	1.996834
-2	2	0	0	-0.000113	0.000113	-0.000113	0.000113
-2	2	Neg FS	-1.996	-1.996800	-1.995200	-1.996834	-1.995166
-1	1	Pos FS	0.998	0.997596	0.998404	0.997579	0.998421
-1	1	0	0	-0.000061	0.000061	-0.000061	0.000061
-1	1	Neg FS	-0.998	-0.998404	-0.997596	-0.998421	-0.997579
-0.5	0.5	Pos FS	0.499	0.498794	0.499206	0.498785	0.499215
-0.5	0.5	0	0	-0.000035	0.000035	-0.000035	0.000035
-0.5	0.5	Neg FS	-0.499	-0.499206	-0.498794	-0.499215	-0.498785
-0.2	0.2	Pos FS	0.1996	0.199502	0.199698	0.199499	0.199701
-0.2	0.2	0	0	-0.000019	0.000019	-0.000019	0.000019
-0.2	0.2	Neg FS	-0.1996	-0.199698	-0.199502	-0.199701	-0.199499
-0.1	0.1	Pos FS	0.0998	0.099741	0.099859	0.099739	0.099861

Table 20. NI 6030E/6031E/6032E/6033E Analog Input Values (Continued)

Range (V)		Test Point		24-Hour Limits		1-Year Limits	
Minimum	Maximum	Location	Value (V)	Lower Limit (V)	Upper Limit (V)	Lower Limit (V)	Upper Limit (V)
-0.1	0.1	0	0	-0.000015	0.000015	-0.000015	0.000015
-0.1	0.1	Neg FS	-0.0998	-0.099859	-0.099741	-0.099861	-0.099739
0	10	Pos FS	9.98	9.979198	9.980802	9.979028	9.980972
0	10	0	0.02	0.019636	0.020364	0.019636	0.020364
0	5	Pos FS	4.99	4.988098	4.991902	4.988013	4.991987
0	5	0	0.01	0.009811	0.010189	0.009811	0.010189
0	2	Pos FS	1.996	1.995234	1.996766	1.995200	1.996800
0	2	0	0.004	0.003920	0.004080	0.003920	0.004080
0	1	Pos FS	0.998	0.997613	0.998387	0.997596	0.998404
0	1	0	0.002	0.001956	0.002044	0.001956	0.002044
0	0.5	Pos FS	0.499	0.498802	0.499198	0.498793	0.499207
0	0.5	0	0.001	0.000973	0.001027	0.000973	0.001027
0	0.2	Pos FS	0.1996	0.199505	0.199695	0.199502	0.199698
0	0.2	0	0.0004	0.000384	0.000416	0.000384	0.000416
0	0.1	Pos FS	0.0998	0.099743	0.099857	0.099741	0.099859
0	0.1	0	0.0002	0.000187	0.000213	0.000187	0.000213

Table 21. NI 6030E/6031E/6032E/6033E Analog Output Values

Range (V)		Test Point		24-Hour Limits		1-Year Limits	
Minimum	Maximum	Location	Value (V)	Lower Limit (V)	Upper Limit (V)	Lower Limit (V)	Upper Limit (V)
-10	10	Pos FS	9.9800000	9.978738	9.981262	9.978568	9.981432
-10	10	0	0.0000000	-0.000813	0.000813	-0.000813	0.000813
-10	10	Neg FS	-9.9800000	-9.981262	-9.978738	-9.981432	-9.978568
0	10	Pos FS	9.9800000	9.978967	9.981033	9.978797	9.981203
0	10	0	0.0200000	0.019415	0.020585	0.019415	0.020585

Table 22. NI 6030E/6031E/6032E/6033E Counter Values

Set Point (MHz)	Lower Limit (MHz)	Upper Limit (MHz)
5	4.99950	5.00050

NI 6034E/6035E/6036E (16-Bit Resolution)

Tables 23 through 26 include values for the PCI-6034E (analog input only), PCI-6035E, and PCI-6036E.

Table 23. NI 6034E/6035E/6036E Analog Input Values

Range (V)		Test Point		24-Hour Limits		1-Year Limits	
Minimum	Maximum	Location	Value (V)	Lower Limit (V)	Upper Limit (V)	Lower Limit (V)	Upper Limit (V)
-10	10	Pos FS	9.900	9.8929	9.9071	9.8925	9.9075
-10	10	0	0.000	-0.0017	0.0017	-0.0017	0.0017
-10	10	Neg FS	-9.900	-9.9071	-9.8929	-9.9075	-9.8925
-5	5	Pos FS	4.950	4.9484	4.9516	4.9482	4.9518
-5	5	0	0.000	-0.0009	0.0009	-0.0009	0.0009
-5	5	Neg FS	-4.950	-4.9516	-4.9484	-4.9518	-4.9482
-0.5	0.5	Pos FS	0.495	0.49462	0.49538	0.49460	0.49540
-0.5	0.5	0	0.000	-0.00011	0.00011	-0.00011	0.00011
-0.5	0.5	Neg FS	-0.495	-0.49538	-0.49462	-0.49540	-0.49460
-0.05	0.05	Pos FS	0.0495	0.049441	0.049559	0.049439	0.049561
-0.05	0.05	0	0.000	-0.000032	0.000032	-0.000032	0.000032
-0.05	0.05	Neg FS	-0.0495	-0.049559	-0.049441	-0.049561	-0.049439

Table 24. NI 6035E Analog Output Values

Range (V)		Test Point		24-Hour Limits		1-Year Limits	
Minimum	Maximum	Location	Value (V)	Lower Limit (V)	Upper Limit (V)	Lower Limit (V)	Upper Limit (V)
-10	10	Pos FS	9.9000000	9.892315	9.907685	9.891899	9.908101
-10	10	0	0.0000000	-0.005933	0.005933	-0.005933	0.005933
-10	10	Neg FS	-9.9000000	-9.907685	-9.892315	-9.908101	-9.891899

Table 25. NI 6036E Analog Output Values

Range (V)		Test Point		24-Hour Limits		1-Year Limits	
Minimum	Maximum	Location	Value (V)	Lower Limit (V)	Upper Limit (V)	Lower Limit (V)	Upper Limit (V)
-10	10	Pos FS	9.9000000	9.898009	9.901991	9.897603	9.902397
-10	10	0	0.0000000	-0.001100	0.001100	-0.001100	0.001100
-10	10	Neg FS	-9.9000000	-9.901991	-9.898009	-9.902397	-9.897603

Table 26. NI 6034E/6035E/6036E Counter Values

Set Point (MHz)	Lower Limit (MHz)	Upper Limit (MHz)
5	4.99950	5.00050

NI DAQCard-6036E (16-Bit Resolution)

Tables 27 through 29 include values for the DAQCard-6036E.

Table 27. NI DAQCard-6036E Analog Input Values

Range (V)		Test Point		24-Hour Limits		1-Year Limits	
Minimum	Maximum	Location	Value (V)	Lower Limit (V)	Upper Limit (V)	Lower Limit (V)	Upper Limit (V)
-10	10	Pos FS	9.900	9.8918	9.9082	9.8914	9.9086
-10	10	0	0.000	-0.0027	0.0027	-0.0027	0.0027
-10	10	Neg FS	-9.900	-9.9082	-9.8918	-9.9086	-9.8914
-5	5	Pos FS	4.950	4.9479	4.9521	4.9477	4.9523
-5	5	0	0.000	-0.0014	0.0014	-0.0014	0.0014
-5	5	Neg FS	-4.950	-4.9521	-4.9479	-4.9523	-4.9477
-0.5	0.5	Pos FS	0.495	0.49457	0.49543	0.49455	0.49545
-0.5	0.5	0	0.000	-0.00016	0.00016	-0.00016	0.00016
-0.5	0.5	Neg FS	-0.495	-0.49543	-0.49457	-0.49545	-0.49455
-0.05	0.05	Pos FS	0.0495	0.049436	0.049564	0.049434	0.049566
-0.05	0.05	0	0.000	-0.000037	0.000037	-0.000037	0.000037
-0.05	0.05	Neg FS	-0.0495	-0.049564	-0.049436	-0.049566	-0.049434

Table 28. NI DAQCard-6036E Analog Output Values

Range (V)		Test Point		24-Hour Limits		1-Year Limits	
Minimum	Maximum	Location	Value (V)	Lower Limit (V)	Upper Limit (V)	Lower Limit (V)	Upper Limit (V)
-10	10	Pos FS	9.9000000	9.897879	9.902121	9.897463	9.902537
-10	10	0	0.0000000	-0.001220	0.001220	-0.001220	0.001220
-10	10	Neg FS	-9.9000000	-9.902121	-9.897879	-9.902537	-9.897463

Table 29. NI DAQCard-6036E Counter Values

Set Point (MHz)	Lower Limit (MHz)	Upper Limit (MHz)
5	4.99950	5.00050

NI 6040E (12-Bit Resolution)

Tables 30 through 32 include values for the PCI-MIO-16E-4 and PXI-6040E.

Table 30. NI 6040E Analog Input Values

Range (V)		Test Point		24-Hour Limits		1-Year Limits	
Minimum	Maximum	Location	Value (V)	Lower Limit (V)	Upper Limit (V)	Lower Limit (V)	Upper Limit (V)
-10	10	Pos FS	9.980000	9.96507	9.99493	9.96465	9.99535
-10	10	0	0.000000	-0.00823	0.00823	-0.00823	0.00823
-10	10	Neg FS	-9.980000	-9.99493	-9.96507	-9.99535	-9.96465

Table 30. NI 6040E Analog Input Values (Continued)

Range (V)		Test Point		24-Hour Limits		1-Year Limits	
Minimum	Maximum	Location	Value (V)	Lower Limit (V)	Upper Limit (V)	Lower Limit (V)	Upper Limit (V)
-5	5	Pos FS	4.99	4.98452	4.99548	4.98431	4.99569
-5	5	0	0.000000	-0.00412	0.00412	-0.00412	0.00412
-5	5	Neg FS	-4.99	-4.99548	-4.98452	-4.99569	-4.98431
-2.5	2.5	Pos FS	2.495000	2.49125	2.49875	2.49115	2.49885
-2.5	2.5	0	0.000000	-0.00207	0.00207	-0.00207	0.00207
-2.5	2.5	Neg FS	-2.495000	-2.49875	-2.49125	-2.49885	-2.49115
-1	1	Pos FS	0.998000	0.99649	0.99951	0.99645	0.99955
-1	1	0	0.000000	-0.00084	0.00084	-0.00084	0.00084
-1	1	Neg FS	-0.998000	-0.99951	-0.99649	-0.99955	-0.99645
-0.5	0.5	Pos FS	0.499000	0.49823	0.49977	0.49821	0.49979
-0.5	0.5	0	0.000000	-0.00043	0.00043	-0.00043	0.00043
-0.5	0.5	Neg FS	-0.499000	-0.49977	-0.49823	-0.49979	-0.49821
-0.25	0.25	Pos FS	0.249500	0.24911	0.24989	0.24910	0.24990
-0.25	0.25	0	0.000000	-0.00023	0.00023	-0.00023	0.00023
-0.25	0.25	Neg FS	-0.249500	-0.24989	-0.24911	-0.24990	-0.24910
-0.1	0.1	Pos FS	0.099800	0.09963	0.09997	0.09962	0.09998

Table 30. NI 6040E Analog Input Values (Continued)

Range (V)		Test Point		24-Hour Limits		1-Year Limits	
Minimum	Maximum	Location	Value (V)	Lower Limit (V)	Upper Limit (V)	Lower Limit (V)	Upper Limit (V)
-0.1	0.1	0	0.000000	-0.00011	0.00011	-0.00011	0.00011
-0.1	0.1	Neg FS	-0.099800	-0.09997	-0.09963	-0.09998	-0.09962
-0.05	0.05	Pos FS	0.049900	0.04980	0.05000	0.04980	0.05000
-0.05	0.05	0	0.000000	-0.00006	0.00006	-0.00006	0.00006
-0.05	0.05	Neg FS	-0.049900	-0.05000	-0.04980	-0.05000	-0.04980
0	10	Pos FS	9.980000	9.97316	9.98684	9.97274	9.98726
0	10	0	0.020000	0.01587	0.02413	0.01587	0.02413
0	5	Pos FS	4.990000	4.98458	4.99542	4.98437	4.99563
0	5	0	0.010000	0.00792	0.01208	0.00792	0.01208
0	2	Pos FS	1.996000	1.99382	1.99818	1.99373	1.99827
0	2	0	0.004000	0.00316	0.00484	0.00316	0.00484
0	1	Pos FS	0.998000	0.99690	0.99910	0.99686	0.99914
0	1	0	0.002000	0.00157	0.00243	0.00157	0.00243
0	0.5	Pos FS	0.499000	0.49844	0.49956	0.49842	0.49958
0	0.5	0	0.001000	0.00077	0.00123	0.00077	0.00123
0	0.2	Pos FS	0.199600	0.199361	0.199839	0.199352	0.199848

Table 30. NI 6040E Analog Input Values (Continued)

Range (V)		Test Point		24-Hour Limits		1-Year Limits	
Minimum	Maximum	Location	Value (V)	Lower Limit (V)	Upper Limit (V)	Lower Limit (V)	Upper Limit (V)
0	0.2	0	0.000400	0.000295	0.000505	0.000295	0.000505
0	0.1	Pos FS	0.099800	0.099669	0.099931	0.099665	0.099935
0	0.1	0	0.000200	0.000136	0.000264	0.000136	0.000264

Table 31. NI 6040E Analog Output Values

Range (V)		Test Point		24-Hour Limits		1-Year Limits	
Minimum	Maximum	Location	Value (V)	Lower Limit (V)	Upper Limit (V)	Lower Limit (V)	Upper Limit (V)
-10	10	Pos FS	9.98	9.972304	9.987696	9.971884	9.988116
-10	10	0	0	-0.005930	0.005930	-0.005930	0.005930
-10	10	Neg FS	-9.98	-9.987696	-9.972304	-9.988116	-9.971884
0	10	Pos FS	9.98	9.974744	9.985256	9.974324	9.985676
0	10	0	0.02	0.016506	0.023494	0.016506	0.023494

Table 32. NI 6040E Counter Values

Set Point (MHz)	Lower Limit (MHz)	Upper Limit (MHz)
5	4.99950	5.00050

NI 6052E (16-Bit Resolution)

Tables 33 through 35 include values for the PCI-6052E and PXI-6052E.

Table 33. NI 6052E Analog Input Values

Range (V)		Test Point		24-Hour Limits		1-Year Limits	
Minimum	Maximum	Location	Value (V)	Lower Limit (V)	Upper Limit (V)	Lower Limit (V)	Upper Limit (V)
-10	10	Pos FS	9.800	9.7955	9.8045	9.7953	9.8047
-10	10	0	0.00	-0.0010	0.0010	-0.0010	0.0010
-10	10	Neg FS	-9.800	-9.8045	-9.7955	-9.8047	-9.7953
-5	5	Pos FS	4.900	4.8992	4.9008	4.8991	4.9009
-5	5	0	0.000	-0.0005	0.0005	-0.0005	0.0005
-5	5	Neg FS	-4.900	-4.9008	-4.8992	-4.9009	-4.8991
-2.5	2.5	Pos FS	2.450	2.44887	2.45113	2.44883	2.45117
-2.5	2.5	0	0.000	-0.00026	0.00026	-0.00026	0.00026
-2.5	2.5	Neg FS	-2.450	-2.45113	-2.44887	-2.45117	-2.44883
-1	1	Pos FS	0.980	0.9795	0.9805	0.9795	0.9805
-1	1	0	0.000	-0.0001	0.0001	-0.0001	0.0001
-1	1	Neg FS	-0.980	-0.9805	-0.9795	-0.9805	-0.9795
-0.5	0.5	Pos FS	0.490	0.48977	0.49023	0.48976	0.49024
-0.5	0.5	0	0.000	-0.00006	0.00006	-0.00006	0.00006

Table 33. NI 6052E Analog Input Values (Continued)

Range (V)		Test Point		24-Hour Limits		1-Year Limits	
Minimum	Maximum	Location	Value (V)	Lower Limit (V)	Upper Limit (V)	Lower Limit (V)	Upper Limit (V)
-0.5	0.5	Neg FS	-0.490	-0.49023	-0.48977	-0.49024	-0.48976
-0.25	0.25	Pos FS	0.245	0.2449	0.2451	0.2449	0.2451
-0.25	0.25	0	0.000	-0.0000316	0.0000316	-0.0000316	0.0000316
-0.25	0.25	Neg FS	-0.245	-0.2451	-0.2449	-0.2451	-0.2449
-0.1	0.1	Pos FS	0.098	0.09794	0.09806	0.09794	0.09806
-0.1	0.1	0	0.000	-0.0000165	0.0000165	-0.0000165	0.0000165
-0.1	0.1	Neg FS	-0.098	-0.09806	-0.09794	-0.09806	-0.09794
-0.05	0.05	Pos FS	0.049	0.048966	0.049034	0.048965	0.049035
-0.05	0.05	0	0.000	-0.000012	0.000012	-0.000012	0.000012
-0.05	0.05	Neg FS	-0.049	-0.049034	-0.048966	-0.049035	-0.048965
0	10	Pos FS	9.8	9.798951	9.801049	9.798785	9.801215
0	10	0	0.0098	0.009280	0.010320	0.009280	0.010320
0	5	Pos FS	4.9	4.898003	4.901997	4.897919	4.902081
0	5	0	0.0098	0.009534	0.010066	0.009534	0.010066
0	2	Pos FS	1.96	1.959198	1.960802	1.959165	1.960835
0	2	0	0.0098	0.009689	0.009911	0.009688	0.009912

Table 33. NI 6052E Analog Input Values (Continued)

Range (V)		Test Point		24-Hour Limits		1-Year Limits	
Minimum	Maximum	Location	Value (V)	Lower Limit (V)	Upper Limit (V)	Lower Limit (V)	Upper Limit (V)
0	1	Pos FS	0.98	0.979547	0.980453	0.979530	0.980470
0	1	0	0.0098	0.009739	0.009861	0.009739	0.009861
0	0.5	Pos FS	0.49	0.489746	0.490254	0.489738	0.490262
0	0.5	0	0.0098	0.009764	0.009836	0.009764	0.009836
0	0.2	Pos FS	0.196	0.195895	0.196105	0.195891	0.196109
0	0.2	0	0.0098	0.009779	0.009821	0.009779	0.009821
0	0.1	Pos FS	0.098	0.097944	0.098056	0.097942	0.098058
0	0.1	0	0.0098	0.009784	0.009816	0.009784	0.009816

Table 34. NI 6052E Analog Output Values

Range (V)		Test Point		24-Hour Limits		1-Year Limits	
Minimum	Maximum	Location	Value (V)	Lower Limit (V)	Upper Limit (V)	Lower Limit (V)	Upper Limit (V)
-10	10	Pos FS	9.8000000	9.798771	9.801229	9.798604	9.801396
-10	10	0	0.0000000	-0.000798	0.000798	-0.000798	0.000798
-10	10	Neg FS	-9.8000000	-9.801229	-9.798771	-9.801396	-9.798604
0	10	Pos FS	9.8000000	9.799000	9.801000	9.798833	9.801167
0	10	0	0.0098000	0.009231	0.010369	0.009230	0.010370

Table 35. NI 6052E Counter Values

Set Point (MHz)	Lower Limit (MHz)	Upper Limit (MHz)
5	4.99950	5.00050

NI DAQCard-6062E (12-Bit Resolution)

Tables 36 through 38 include values for the DAQCard-6062E.

Table 36. NI DAQCard-6062E Analog Input Values

Range (V)		Test Point		24-Hour Limits		1-Year Limits	
Minimum	Maximum	Location	Value (V)	Lower Limit (V)	Upper Limit (V)	Lower Limit (V)	Upper Limit (V)
-10	10	Pos FS	9.80000	9.7802	9.8198	9.7797	9.8203
-10	10	0	0.000000	-0.0108	0.0108	-0.0108	0.0108
-10	10	Neg FS	-9.80000	-9.8198	-9.7802	-9.8203	-9.7797
-5	5	Pos FS	4.900000	4.8926	4.9074	4.8924	4.9076
-5	5	0	0.000000	-0.0054	0.0054	-0.0054	0.0054
-5	5	Neg FS	-4.900000	-4.9074	-4.8926	-4.9076	-4.8924
-2.5	2.5	Pos FS	2.450000	2.44503	2.45497	2.44492	2.45508
-2.5	2.5	0	0.000000	-0.00271	0.00271	-0.00271	0.00271
-2.5	2.5	Neg FS	-2.450000	-2.45497	-2.44503	-2.45508	-2.44492
-1	1	Pos FS	0.980000	0.977997	0.982003	0.977956	0.982044
-1	1	0	0.000000	-0.001099	0.001099	-0.001099	0.001099
-1	1	Neg FS	-0.980000	-0.982003	-0.977997	-0.982044	-0.977956
-0.5	0.5	Pos FS	0.490000	0.4890	0.4910	0.4890	0.4910
-0.5	0.5	0	0.000000	-0.0006	0.0006	-0.0006	0.0006

Table 36. NI DAQCard-6062E Analog Input Values (Continued)

Range (V)		Test Point		24-Hour Limits		1-Year Limits	
Minimum	Maximum	Location	Value (V)	Lower Limit (V)	Upper Limit (V)	Lower Limit (V)	Upper Limit (V)
-0.5	0.5	Neg FS	-0.490000	-0.4910	-0.4890	-0.4910	-0.4890
-0.25	0.25	Pos FS	0.245000	0.2445	0.2455	0.2445	0.2455
-0.25	0.25	0	0.000000	-0.0003	0.0003	-0.0003	0.0003
-0.25	0.25	Neg FS	-0.245000	-0.2455	-0.2445	-0.2455	-0.2445
-0.1	0.1	Pos FS	0.098000	0.09778	0.09822	0.09777	0.09823
-0.1	0.1	0	0.000000	-0.00013	0.00013	-0.00013	0.00013
-0.1	0.1	Neg FS	-0.098000	-0.09822	-0.09778	-0.09823	-0.09777
-0.05	0.05	Pos FS	0.049000	0.048877	0.049123	0.048875	0.049125
-0.05	0.05	0	0.000000	-0.000078	0.000078	-0.000078	0.000078
-0.05	0.05	Neg FS	-0.049000	-0.049123	-0.048877	-0.049125	-0.048875
0	10	Pos FS	9.800000	9.7907	9.8093	9.7903	9.8097
0	10	0	0.020000	0.0146	0.0254	0.0146	0.0254
0	5	Pos FS	4.900000	4.8928	4.9072	4.8926	4.9074
0	5	0	0.010000	0.0073	0.0127	0.0073	0.0127
0	2	Pos FS	1.996000	1.9930	1.9990	1.9900	2.0020
0	2	0	0.004000	0.0029	0.0051	0.0029	0.0051

Table 36. NI DAQCard-6062E Analog Input Values (Continued)

Range (V)		Test Point		24-Hour Limits		1-Year Limits	
Minimum	Maximum	Location	Value (V)	Lower Limit (V)	Upper Limit (V)	Lower Limit (V)	Upper Limit (V)
0	1	Pos FS	0.980000	0.97854	0.98146	0.97850	0.98150
0	1	0	0.002000	0.00144	0.00256	0.00144	0.00256
0	0.5	Pos FS	0.490000	0.48925	0.49075	0.48923	0.49077
0	0.5	0	0.001000	0.00070	0.00130	0.00070	0.00130
0	0.2	Pos FS	0.199600	0.199249	0.199951	0.198889	0.200311
0	0.2	0	0.000400	0.000269	0.000531	0.000269	0.000531
0	0.1	Pos FS	0.09980	0.0983	0.1013	0.0968	0.1028
0	0.1	0	0.000200	0.0001	0.0003	0.0001	0.0003

Table 37. NI DAQCard-6062E Analog Output Values

Range (V)		Test Point		24-Hour Limits		1-Year Limits	
Minimum	Maximum	Location	Value (V)	Lower Limit (V)	Upper Limit (V)	Lower Limit (V)	Upper Limit (V)
-10	10	Pos FS	9.8000000	9.789895	9.810105	9.789484	9.810516
-10	10	0	0	-0.008370	0.008370	-0.008370	0.008370
-10	10	Neg FS	-9.8000000	-9.810105	-9.789895	-9.810516	-9.789484

Table 38. NI DAQCard-6062E Counter Values

Set Point (MHz)	Lower Limit (MHz)	Upper Limit (MHz)
5	4.99950	5.00050

NI 6070E/6071E (12-Bit Resolution)

Tables 39 through 41 include values for the PCI-MIO-16E-1, PCI-6070E, PXI-6070E, PCI-6071E, and PXI-6071E.

Table 39. NI 6070E/6071E Analog Input Values

Range (V)		Test Point		24-Hour Limits		1-Year Limits	
Minimum	Maximum	Location	Value (V)	Lower Limit (V)	Upper Limit (V)	Lower Limit (V)	Upper Limit (V)
-10	10	Pos FS	9.980000	9.96607	9.99393	9.96565	9.99435
-10	10	0	0.00000	-0.00723	0.00723	-0.00723	0.00723
-10	10	Neg FS	-9.980000	-9.99393	-9.96607	-9.99435	-9.96565
-5	5	Pos FS	4.990000	4.98502	4.99498	4.98481	4.99519
-5	5	0	0.00000	-0.00362	0.00362	-0.00362	0.00362
-5	5	Neg FS	-4.990000	-4.99498	-4.98502	-4.99519	-4.98481
-2.5	2.5	Pos FS	2.495000	2.49150	2.49850	2.49140	2.49860
-2.5	2.5	0	0.00000	-0.00182	0.00182	-0.00182	0.00182
-2.5	2.5	Neg FS	-2.495000	-2.49850	-2.49150	-2.49860	-2.49140
-1	1	Pos FS	0.998000	0.99659	0.99941	0.99655	0.99945

Table 39. NI 6070E/6071E Analog Input Values (Continued)

Range (V)		Test Point		24-Hour Limits		1-Year Limits	
Minimum	Maximum	Location	Value (V)	Lower Limit (V)	Upper Limit (V)	Lower Limit (V)	Upper Limit (V)
-1	1	0	0.00000	-0.00074	0.00074	-0.00074	0.00074
-1	1	Neg FS	-0.998000	-0.99941	-0.99659	-0.99945	-0.99655
-0.5	0.5	Pos FS	0.499000	0.49829	0.49971	0.49827	0.49973
-0.5	0.5	0	0.00000	-0.00038	0.00038	-0.00038	0.00038
-0.5	0.5	Neg FS	-0.499000	-0.49971	-0.49829	-0.49973	-0.49827
-0.25	0.25	Pos FS	0.249500	0.24913	0.24987	0.24912	0.24988
-0.25	0.25	0	0.00000	-0.00020	0.00020	-0.00020	0.00020
-0.25	0.25	Neg FS	-0.249500	-0.24987	-0.24913	-0.24988	-0.24912
-0.1	0.1	Pos FS	0.099800	0.09964	0.09996	0.09964	0.09996
-0.1	0.1	0	0.00000	-0.00009	0.00009	-0.00009	0.00009
-0.1	0.1	Neg FS	-0.099800	-0.09996	-0.09964	-0.09996	-0.09964
-0.05	0.05	Pos FS	0.049900	0.04981	0.04999	0.04981	0.04999
-0.05	0.05	0	0.00000	-0.00006	0.00006	-0.00006	0.00006
-0.05	0.05	Neg FS	-0.049900	-0.04999	-0.04981	-0.04999	-0.04981
0	10	Pos FS	9.980000	9.97366	9.98634	9.97324	9.98676
0	10	0	0.020000	0.01637	0.02363	0.01637	0.02363

Table 39. NI 6070E/6071E Analog Input Values (Continued)

Range (V)		Test Point		24-Hour Limits		1-Year Limits	
Minimum	Maximum	Location	Value (V)	Lower Limit (V)	Upper Limit (V)	Lower Limit (V)	Upper Limit (V)
0	5	Pos FS	4.990000	4.98483	4.99517	4.98462	4.99538
0	5	0	0.010000	0.00817	0.01183	0.00817	0.01183
0	2	Pos FS	1.996000	1.99392	1.99808	1.99384	1.99816
0	2	0	0.004000	0.00326	0.00474	0.00326	0.00474
0	1	Pos FS	0.998000	0.99695	0.99905	0.99691	0.99909
0	1	0	0.002000	0.00162	0.00238	0.00162	0.00238
0	0.5	Pos FS	0.499000	0.49846	0.49954	0.49844	0.49956
0	0.5	0	0.001000	0.00080	0.00120	0.00080	0.00120
0	0.2	Pos FS	0.199600	0.199374	0.199826	0.199365	0.199835
0	0.2	0	0.000400	0.000308	0.000492	0.000308	0.000492
0	0.1	Pos FS	0.099800	0.099677	0.099923	0.099673	0.099927
0	0.1	0	0.000200	0.000144	0.000256	0.000144	0.000256

Table 40. NI 6070E/6071E Analog Output Values

Range (V)		Test Point		24-Hour Limits		1-Year Limits	
Minimum	Maximum	Location	Value (V)	Lower Limit (V)	Upper Limit (V)	Lower Limit (V)	Upper Limit (V)
-10	10	Pos FS	9.98	9.972304	9.987696	9.971884	9.988116
-10	10	0	0	-0.005930	0.005930	-0.005930	0.005930
-10	10	Neg FS	-9.98	-9.987696	-9.972304	-9.988116	-9.971884
0	10	Pos FS	9.98	9.974744	9.985256	9.974324	9.985676
0	10	0	0.02	0.016506	0.023494	0.016506	0.023494

Table 41. NI 6070E/6071E Counter Values

Set Point (MHz)	Lower Limit (MHz)	Upper Limit (MHz)
5	4.99950	5.00050

M Series Test Limits

NI USB-6210/6211/6215/6218 (16-Bit Resolution)

Tables 42 through 44 include values for all USB-6210 (analog input only), USB-6211, USB-6215, and USB-6218 variants.

Table 42. NI USB-6210/6211/6215/6218 Analog Input Values

Range (V)		Test Point		24-Hour Limits		1-Year Limits	
Minimum	Maximum	Location	Value (V)	Lower Limit (V)	Upper Limit (V)	Lower Limit (V)	Upper Limit (V)
-10	10	Pos FS	9.980000	9.978209	9.981791	9.977311	9.982689
-10	10	0.000000	0.000000	-0.001369	0.001369	-0.001369	0.001369
-10	10	Neg FS	-9.980000	-9.981791	-9.978209	-9.982689	-9.977311
-5	5	Pos FS	4.990000	4.989044	4.990956	4.988595	4.991405
-5	5	0.000000	0.000000	-0.000695	0.000695	-0.000695	0.000695
-5	5	Neg FS	-4.990000	-4.990956	-4.989044	-4.991405	-4.988595
-1	1	Pos FS	0.998000	0.997780	0.998220	0.997690	0.998310
-1	1	0.000000	0.000000	-0.000158	0.000158	-0.000158	0.000158
-1	1	Neg FS	-0.998000	-0.998220	-0.997780	-0.998310	-0.997690
-0.2	0.2	Pos FS	0.199600	0.199530	0.199670	0.199512	0.199688
-0.2	0.2	0.000000	0.000000	-0.000050	0.000050	-0.000050	0.000050
-0.2	0.2	Neg FS	-0.199600	-0.199670	-0.199530	-0.199688	-0.199512

Table 43. NI USB-6211/6215/6218 Analog Output Values

Range (V)		Test Point		24-Hour Limits		1-Year Limits	
Minimum	Maximum	Location	Value (V)	Lower Limit (V)	Upper Limit (V)	Lower Limit (V)	Upper Limit (V)
-10	10	Pos FS	9.980000	9.977391	9.982609	9.976493	9.983507
-10	10	0.000000	0.000000	-0.002000	0.002000	-0.002000	0.002000
-10	10	Neg FS	-9.980000	-9.982609	-9.977391	-9.983507	-9.976493

Table 44. NI USB-6210/6211/6215/6218 Counter Values

Set Point (MHz)	Lower Limit (MHz)	Upper Limit (MHz)
5	4.99975	5.00025

NI USB-6212/6216 (16-Bit Resolution)

Tables 45 through 47 include values for all USB-6212 and USB-6216 variants.

Table 45. NI USB-6212/6216 Analog Input Values

Range (V)		Test Point		24-Hour Limits		1-Year Limits	
Minimum	Maximum	Location	Value (V)	Lower Limit (V)	Upper Limit (V)	Lower Limit (V)	Upper Limit (V)
-10	10	Pos FS	9.980000	9.978189	9.981811	9.977291	9.982709
-10	10	0.000000	0.000000	-0.001389	0.001389	-0.001389	0.001389
-10	10	Neg FS	-9.980000	-9.981811	-9.978189	-9.982709	-9.977291

Table 45. NI USB-6212/6216 Analog Input Values (Continued)

Range (V)		Test Point		24-Hour Limits		1-Year Limits	
Minimum	Maximum	Location	Value (V)	Lower Limit (V)	Upper Limit (V)	Lower Limit (V)	Upper Limit (V)
-5	5	Pos FS	4.990000	4.989034	4.990966	4.988585	4.991415
-5	5	0.000000	0.000000	-0.000705	0.000705	-0.000705	0.000705
-5	5	Neg FS	-4.990000	-4.990966	-4.989034	-4.991415	-4.988585
-1	1	Pos FS	0.998000	0.997778	0.998222	0.997688	0.998312
-1	1	0.000000	0.000000	-0.000160	0.000160	-0.000160	0.000160
-1	1	Neg FS	-0.998000	-0.998222	-0.997778	-0.998312	-0.997688
-0.2	0.2	Pos FS	0.199600	0.199529	0.199671	0.199511	0.199689
-0.2	0.2	0.000000	0.000000	-0.000050	0.000050	-0.000050	0.000050
-0.2	0.2	Neg FS	-0.199600	-0.199671	-0.199529	-0.199689	-0.199511

Table 46. NI USB-6212/6216 Analog Output Values

Range (V)		Test Point		24-Hour Limits		1-Year Limits	
Minimum	Maximum	Location	Value (V)	Lower Limit (V)	Upper Limit (V)	Lower Limit (V)	Upper Limit (V)
-10	10	Pos FS	9.980000	9.977391	9.982609	9.976493	9.983507
-10	10	0.000000	0.000000	-0.002000	0.002000	-0.002000	0.002000
-10	10	Neg FS	-9.980000	-9.982609	-9.977391	-9.983507	-9.976493

Table 47. NI USB-6212/6216 Counter Values

Set Point (MHz)	Lower Limit (MHz)	Upper Limit (MHz)
5.00000	4.99975	5.00025

NI 6220/6221/6224/6225/6229 (16-Bit Resolution)

Tables 48 through 50 include values for the PCI-6220 (analog input only), PXI-6220 (analog input only), PCI-6221 (37-pin), PCI-6221 (68-pin), PXI-6221, all USB-6221 variants, PCI-6224 (analog input only), PXI-6224 (analog input only), PCI-6225, PXI-6225, all USB-6225 variants, PCI-6229, PXI-6229, and all USB-6229 variants.

Table 48. NI 6220/6221/6224/6225/6229 Analog Input Values

Range (V)		Test Point		24-Hour Limits		1-Year Limits	
Minimum	Maximum	Location	Value (V)	Lower Limit (V)	Upper Limit (V)	Lower Limit (V)	Upper Limit (V)
-10	10	Pos FS	9.980000	9.977798	9.982202	9.976900	9.983100
-10	10	0	0.000000	-0.001603	0.001603	-0.001603	0.001603
-10	10	Neg FS	-9.980000	-9.982202	-9.977798	-9.983100	-9.976900
-5	5	Pos FS	4.990000	4.988834	4.991166	4.988385	4.991615
-5	5	0	0.000000	-0.000817	0.000817	-0.000817	0.000817
-5	5	Neg FS	-4.990000	-4.991166	-4.988834	-4.991615	-4.988385
-1	1	Pos FS	0.998000	0.997731	0.998269	0.997641	0.998359
-1	1	0	0.000000	-0.000189	0.000189	-0.000189	0.000189
-1	1	Neg FS	-0.998000	-0.998269	-0.997731	-0.998359	-0.997641

Table 48. NI 6220/6221/6224/6225/6229 Analog Input Values (Continued)

Range (V)		Test Point		24-Hour Limits		1-Year Limits	
Minimum	Maximum	Location	Value (V)	Lower Limit (V)	Upper Limit (V)	Lower Limit (V)	Upper Limit (V)
-0.2	0.2	Pos FS	0.199600	0.199506	0.199694	0.199488	0.199712
-0.2	0.2	0	0.000000	-0.000070	0.000070	-0.000070	0.000070
-0.2	0.2	Neg FS	-0.199600	-0.199694	-0.199506	-0.199712	-0.199488

Table 49. NI 6221/6225/6229 Analog Output Values

Range (V)		Test Point		24-Hour Limits		1-Year Limits	
Minimum	Maximum	Location	Value (V)	Lower Limit (V)	Upper Limit (V)	Lower Limit (V)	Upper Limit (V)
-10	10	Pos FS	9.980000	9.977671	9.982329	9.976773	9.983227
-10	10	0	0.000000	-0.001730	0.001730	-0.001730	0.001730
-10	10	Neg FS	-9.980000	-9.982329	-9.977671	-9.983227	-9.976773

Table 50. NI 6220/6221/6224/6225/6229 Counter Values

Set Point (MHz)	Lower Limit (MHz)	Upper Limit (MHz)
5	4.99975	5.00025

NI 6250/6251/6254/6255/6259 (16-Bit Resolution)

Tables 51 through 53 include values for the PCI-6250 (analog input only), PXI-6250 (analog input only), PCI-6251, NI PCIe-6251, PXI-6251, NI PXIe-6251, all USB-6251 variants, PCI-6254 (analog input only), PXI-6254 (analog input only), PCI-6255, PXI-6255, all USB-6255 variants, PCI-6259, NI PCIe-6259, PXI-6259, NI PXIe-6259, and all USB-6259 variants.

Table 51. NI 6250/6251/6254/6255/6259 Analog Input Values

Range (V)		Test Point		24-Hour Limits		2-Year Limits	
Minimum	Maximum	Location	Value (V)	Lower Limit (V)	Upper Limit (V)	Lower Limit (V)	Upper Limit (V)
-10	10	Pos FS	9.980000	9.978447	9.981553	9.978078	9.981922
-10	10	0	0.000000	-0.001094	0.001094	-0.001094	0.001094
-10	10	Neg FS	-9.980000	-9.981553	-9.978447	-9.981922	-9.978078
-5	5	Pos FS	4.990000	4.989174	4.990826	4.988989	4.991011
-5	5	0	0.000000	-0.000547	0.000547	-0.000547	0.000547
-5	5	Neg FS	-4.990000	-4.990826	-4.989174	-4.991011	-4.988989
-2	2	Pos FS	1.996000	1.995663	1.996337	1.995589	1.996411
-2	2	0	0.000000	-0.000225	0.000225	-0.000225	0.000225
-2	2	Neg FS	-1.996000	-1.996337	-1.995663	-1.996411	-1.995589
-1	1	Pos FS	0.998000	0.997818	0.998182	0.997781	0.998219
-1	1	0	0.000000	-0.000117	0.000117	-0.000117	0.000117
-1	1	Neg FS	-0.998000	-0.998182	-0.997818	-0.998219	-0.997781
-0.5	0.5	Pos FS	0.499000	0.498889	0.499111	0.498870	0.499130

Table 51. NI 6250/6251/6254/6255/6259 Analog Input Values (Continued)

Range (V)		Test Point		24-Hour Limits		2-Year Limits	
Minimum	Maximum	Location	Value (V)	Lower Limit (V)	Upper Limit (V)	Lower Limit (V)	Upper Limit (V)
-0.5	0.5	0	0.000000	-0.000073	0.000073	-0.000073	0.000073
-0.5	0.5	Neg FS	-0.499000	-0.499111	-0.498889	-0.499130	-0.498870
-0.2	0.2	Pos FS	0.199600	0.199533	0.199667	0.199526	0.199674
-0.2	0.2	0	0.000000	-0.000044	0.000044	-0.000044	0.000044
-0.2	0.2	Neg FS	-0.199600	-0.199667	-0.199533	-0.199674	-0.199526
-0.1	0.1	Pos FS	0.099800	0.099752	0.099848	0.099748	0.099852
-0.1	0.1	0	0.000000	-0.000035	0.000035	-0.000035	0.000035
-0.1	0.1	Neg FS	-0.099800	-0.099848	-0.099752	-0.099852	-0.099748

Table 52. NI 6251/6255/6259 Analog Output Values

Range (V)		Test Point		24-Hour Limits		2-Year Limits	
Minimum	Maximum	Location	Value (V)	Lower Limit (V)	Upper Limit (V)	Lower Limit (V)	Upper Limit (V)
-10	10	Pos FS	9.980000	9.978291	9.981709	9.977922	9.982078
-10	10	0	0.000000	-0.001060	0.001060	-0.001060	0.001060
-10	10	Neg FS	-9.980000	-9.981709	-9.978291	-9.982078	-9.977922
-5	5	Pos FS	4.990000	4.989141	4.990859	4.988956	4.991044
-5	5	0	0.000000	-0.000530	0.000530	-0.000530	0.000530
-5	5	Neg FS	-4.990000	-4.990859	-4.989141	-4.991044	-4.988956

Table 53. NI 6250/6251/6254/6255/6259 Counter Values

Set Point (MHz)	Lower Limit (MHz)	Upper Limit (MHz)
5	4.99975	5.00025

NI 6280/6281/6284/6289 (18-Bit Resolution)

Tables 54 through 57 include values for the PCI-6280 (analog input only), PXI-6280 (analog input only), PCI-6281, PXI-6281, all USB-6281 variants, PCI-6284 (analog input only), PXI-6284 (analog input only), PCI-6289, PXI-6289, and all USB-6289 variants.

Table 54. NI 6280/6281/6284/6289 Analog Input Values (Filter On)

Range (V)		Test Point		24-Hour Limits		2-Year Limits	
Minimum	Maximum	Location	Value (V)	Lower Limit (V)	Upper Limit (V)	Lower Limit (V)	Upper Limit (V)
-10	10	Pos FS	9.980000	9.979393	9.980607	9.979023	9.980977
-10	10	0	0.000000	-0.000308	0.000308	-0.000308	0.000308
-10	10	Neg FS	-9.980000	-9.980607	-9.979393	-9.980977	-9.979023
-5	5	Pos FS	4.990000	4.989671	4.990329	4.989487	4.990513
-5	5	0	0.000000	-0.000154	0.000154	-0.000154	0.000154
-5	5	Neg FS	-4.990000	-4.990329	-4.989671	-4.990513	-4.989487
-2	2	Pos FS	1.996000	1.995865	1.996135	1.995791	1.996209
-2	2	0	0.000000	-0.000066	0.000066	-0.000066	0.000066
-2	2	Neg FS	-1.996000	-1.996135	-1.995865	-1.996209	-1.995791
-1	1	Pos FS	0.998000	0.997913	0.998087	0.997876	0.998124
-1	1	0	0.000000	-0.000042	0.000042	-0.000042	0.000042
-1	1	Neg FS	-0.998000	-0.998087	-0.997913	-0.998124	-0.997876
-0.5	0.5	Pos FS	0.499000	0.498946	0.499054	0.498928	0.499072

Table 54. NI 6280/6281/6284/6289 Analog Input Values (Filter On) (Continued)

Range (V)		Test Point		24-Hour Limits		2-Year Limits	
Minimum	Maximum	Location	Value (V)	Lower Limit (V)	Upper Limit (V)	Lower Limit (V)	Upper Limit (V)
-0.5	0.5	0	0.000000	-0.000031	0.000031	-0.000031	0.000031
-0.5	0.5	Neg FS	-0.499000	-0.499054	-0.498946	-0.499072	-0.498928
-0.2	0.2	Pos FS	0.199600	0.199568	0.199632	0.199561	0.199639
-0.2	0.2	0	0.000000	-0.000019	0.000019	-0.000019	0.000019
-0.2	0.2	Neg FS	-0.199600	-0.199632	-0.199568	-0.199639	-0.199561
-0.1	0.1	Pos FS	0.099800	0.099775	0.099825	0.099772	0.099828
-0.1	0.1	0	0.000000	-0.000014	0.000014	-0.000014	0.000014
-0.1	0.1	Neg FS	-0.099800	-0.099825	-0.099775	-0.099828	-0.099772

Table 55. NI 6280/6281/6284/6289 Analog Input Values (Filter Off)

Range (V)		Test Point		24-Hour Limits		2-Year Limits	
Minimum	Maximum	Location	Value (V)	Lower Limit (V)	Upper Limit (V)	Lower Limit (V)	Upper Limit (V)
-10	10	Pos FS	9.980000	9.979320	9.980680	9.978950	9.981050
-10	10	0	0.000000	-0.000331	0.000331	-0.000331	0.000331
-10	10	Neg FS	-9.980000	-9.980680	-9.979320	-9.981050	-9.978950
-5	5	Pos FS	4.990000	4.989635	4.990365	4.989450	4.990550
-5	5	0	0.000000	-0.000166	0.000166	-0.000166	0.000166
-5	5	Neg FS	-4.990000	-4.990365	-4.989635	-4.990550	-4.989450
-2	2	Pos FS	1.996000	1.995850	1.996150	1.995776	1.996224
-2	2	0	0.000000	-0.000071	0.000071	-0.000071	0.000071
-2	2	Neg FS	-1.996000	-1.996150	-1.995850	-1.996224	-1.995776
-1	1	Pos FS	0.998000	0.997905	0.998096	0.997868	0.998132
-1	1	0	0.000000	-0.000046	0.000046	-0.000046	0.000046
-1	1	Neg FS	-0.998000	-0.998096	-0.997905	-0.998132	-0.997868
-0.5	0.5	Pos FS	0.499000	0.498941	0.499059	0.498923	0.499077
-0.5	0.5	0	0.000000	-0.000034	0.000034	-0.000034	0.000034
-0.5	0.5	Neg FS	-0.499000	-0.499059	-0.498941	-0.499077	-0.498923
-0.2	0.2	Pos FS	0.199600	0.199565	0.199635	0.199558	0.199642

Table 55. NI 6280/6281/6284/6289 Analog Input Values (Filter Off) (Continued)

Range (V)		Test Point		24-Hour Limits		2-Year Limits	
Minimum	Maximum	Location	Value (V)	Lower Limit (V)	Upper Limit (V)	Lower Limit (V)	Upper Limit (V)
-0.2	0.2	0	0.000000	-0.000021	0.000021	-0.000021	0.000021
-0.2	0.2	Neg FS	-0.199600	-0.199635	-0.199565	-0.199642	-0.199558
-0.1	0.1	Pos FS	0.099800	0.099773	0.099827	0.099769	0.099831
-0.1	0.1	0	0.000000	-0.000016	0.000016	-0.000016	0.000016
-0.1	0.1	Neg FS	-0.099800	-0.099827	-0.099773	-0.099831	-0.099769

Table 56. NI 6281/6289 Analog Output Values

Range (V)		Test Point		24-Hour Limits		2-Year Limits	
Minimum	Maximum	Location	Value (V)	Lower Limit (V)	Upper Limit (V)	Lower Limit (V)	Upper Limit (V)
-10	10	Pos FS	9.980000	9.978831	9.981169	9.978462	9.981538
-10	10	0	0.000000	-0.000740	0.000740	-0.000740	0.000740
-10	10	Neg FS	-9.980000	-9.981169	-9.978831	-9.981538	-9.978462
-5	5	Pos FS	4.990000	4.989365	4.990635	4.989181	4.990819
-5	5	0	0.000000	-0.000395	0.000395	-0.000395	0.000395
-5	5	Neg FS	-4.990000	-4.990635	-4.989365	-4.990819	-4.989181
-2	2	Pos FS	1.996000	1.995670	1.996330	1.995596	1.996404
-2	2	0	0.000000	-0.000204	0.000204	-0.000204	0.000204
-2	2	Neg FS	-1.996000	-1.996330	-1.995670	-1.996404	-1.995596
-1	1	Pos FS	0.998000	0.997778	0.998222	0.997741	0.998259
-1	1	0	0.000000	-0.000139	0.000139	-0.000139	0.000139
-1	1	Neg FS	-0.998000	-0.998222	-0.997778	-0.998259	-0.997741

Table 57. NI 6280/6281/6284/6289 Counter Values

Set Point (MHz)	Lower Limit (MHz)	Upper Limit (MHz)
5	4.99975	5.00025

S Series Test Limits

NI 6110/6111 (12-Bit Resolution)

Tables 58 through 60 include values for the PCI-6110 and PCI-6111.

Table 58. NI 6110/6111 Analog Input Values

Range (V)		Test Point		24-Hour Limits		1-Year Limits	
Minimum	Maximum	Location	Value (V)	Lower Limit (V)	Upper Limit (V)	Lower Limit (V)	Upper Limit (V)
-42	42	Pos FS	41.58	41.3301	41.8299	41.3294	41.8306
-42	42	0	0	-0.0391	0.0391	-0.0391	0.0391
-42	42	Neg FS	-41.58	-41.8299	-41.3301	-41.8306	-41.3294
-20	20	Pos FS	19.8	19.6780	19.9220	19.6776	19.9224
-20	20	0	0	-0.0216	0.0216	-0.0216	0.0216
-20	20	Neg FS	-19.8	-19.9220	-19.6780	-19.9224	-19.6776
-10	10	Pos FS	9.9	9.8828	9.9172	9.8826	9.9174
-10	10	0	0	-0.0066	0.0066	-0.0066	0.0066
-10	10	Neg FS	-9.9	-9.9172	-9.8828	-9.9174	-9.8826
-5	5	Pos FS	4.95	4.94376	4.95624	4.94368	4.95632
-5	5	0	0	-0.00341	0.00341	-0.00341	0.00341
-5	5	Neg FS	-4.95	-4.95624	-4.94376	-4.95632	-4.94368
-2	2	Pos FS	1.95	1.94744	1.95256	1.94741	1.95259

Table 58. NI 6110/6111 Analog Input Values (Continued)

Range (V)		Test Point		24-Hour Limits		1-Year Limits	
Minimum	Maximum	Location	Value (V)	Lower Limit (V)	Upper Limit (V)	Lower Limit (V)	Upper Limit (V)
-2	2	0	0	-0.00145	0.00145	-0.00145	0.00145
-2	2	Neg FS	-1.95	-1.95256	-1.94744	-1.95259	-1.94741
-1	1	Pos FS	0.99	0.98865	0.99135	0.98863	0.99137
-1	1	0	0	-0.00079	0.00079	-0.00079	0.00079
-1	1	Neg FS	-0.99	-0.99135	-0.98865	-0.99137	-0.98863
-0.5	0.5	Pos FS	0.495	0.494256	0.495744	0.494248	0.495752
-0.5	0.5	0	0	-0.000461	0.000461	-0.000461	0.000461
-0.5	0.5	Neg FS	-0.495	-0.495744	-0.494256	-0.495752	-0.494248
-0.2	0.2	Pos FS	0.198	0.197648	0.198352	0.197645	0.198355
-0.2	0.2	0	0	-0.000239	0.000239	-0.000239	0.000239
-0.2	0.2	Neg FS	-0.198	-0.198352	-0.197648	-0.198355	-0.197645

Table 59. NI 6110/6111 Analog Output Values

Range (V)		Test Point		24-Hour Limits		1-Year Limits	
Minimum	Maximum	Location	Value (V)	Lower Limit (V)	Upper Limit (V)	Lower Limit (V)	Upper Limit (V)
-10	10	Pos FS	9.99	9.982299	9.997701	9.981879	9.998121
-10	10	0	0	-0.005933	0.005933	-0.005933	0.005933
-10	10	Neg FS	-9.99	-9.997701	-9.982299	-9.998121	-9.981879

Table 60. NI 6110/6111 Counter Values

Set Point (MHz)	Lower Limit (MHz)	Upper Limit (MHz)
5	4.99950	5.00050

NI 6115 (12-Bit Resolution)

Tables 61 through 63 include values for the PCI-6115 and PXI-6115.

Table 61. NI 6115 Analog Input Values

Range (V)		Test Point		24-Hour Limits		1-Year Limits	
Minimum	Maximum	Location	Value (V)	Lower Limit (V)	Upper Limit (V)	Lower Limit (V)	Upper Limit (V)
-42	42	Pos FS	41.16	40.980986	41.339014	40.980163	41.339837
-42	42	0	0	-0.036600	0.036600	-0.036600	0.036600
-42	42	Neg FS	-41.16	-41.339014	-40.980986	-41.339837	-40.980163

Table 61. NI 6115 Analog Input Values (Continued)

Range (V)		Test Point		24-Hour Limits		1-Year Limits	
Minimum	Maximum	Location	Value (V)	Lower Limit (V)	Upper Limit (V)	Lower Limit (V)	Upper Limit (V)
-20	20	Pos FS	19.6	19.532484	19.667516	19.532092	19.667908
-20	20	0	0	-0.014400	0.014400	-0.014400	0.014400
-20	20	Neg FS	-19.6	-19.667516	-19.532484	-19.667908	-19.532092
-10	10	Pos FS	9.8	9.790032	9.809968	9.789836	9.810164
-10	10	0	0	-0.007420	0.007420	-0.007420	0.007420
-10	10	Neg FS	-9.8	-9.809968	-9.790032	-9.810164	-9.789836
-5	5	Pos FS	4.9	4.895456	4.904544	4.895358	4.904642
-5	5	0	0	-0.003760	0.003760	-0.003760	0.003760
-5	5	Neg FS	-4.9	-4.904544	-4.895456	-4.904642	-4.895358
-2	2	Pos FS	1.96	1.957834	1.962166	1.957795	1.962205
-2	2	0	0	-0.001460	0.001460	-0.001460	0.001460
-2	2	Neg FS	-1.96	-1.962166	-1.957834	-1.962205	-1.957795
-1	1	Pos FS	0.98	0.978809	0.981191	0.978789	0.981211
-1	1	0	0	-0.000770	0.000770	-0.000770	0.000770
-1	1	Neg FS	-0.98	-0.981191	-0.978809	-0.981211	-0.978789
-0.5	0.5	Pos FS	0.49	0.489305	0.490695	0.489295	0.490705

Table 61. NI 6115 Analog Input Values (Continued)

Range (V)		Test Point		24-Hour Limits		1-Year Limits	
Minimum	Maximum	Location	Value (V)	Lower Limit (V)	Upper Limit (V)	Lower Limit (V)	Upper Limit (V)
-1	1	0	0	-0.000411	0.000411	-0.000411	0.000411
-1	1	Neg FS	-0.49	-0.490695	-0.489305	-0.490705	-0.489295
-0.2	0.2	Pos FS	0.196	0.195609	0.196391	0.195605	0.196395
-0.2	0.2	0	0	-0.000189	0.000189	-0.000189	0.000189
-0.2	0.2	Neg FS	-0.196	-0.196391	-0.195609	-0.196395	-0.195605

Table 62. NI 6115 Analog Output Values

Range (V)		Test Point		24-Hour Limits		1-Year Limits	
Minimum	Maximum	Location	Value (V)	Lower Limit (V)	Upper Limit (V)	Lower Limit (V)	Upper Limit (V)
-10	10	Pos FS	9.8	9.786817	9.813183	9.786651	9.813349
-10	10	0	0	-0.008900	0.008900	-0.008900	0.008900
-10	10	Neg FS	-9.8	-9.813183	-9.786817	-9.813349	-9.786651

Table 63. NI 6115 Counter Values

Set Point (MHz)	Lower Limit (MHz)	Upper Limit (MHz)
5	4.99950	5.00050

NI 6120 (16-Bit Resolution)

Tables 64 through 66 include values for the PCI-6120 and PXI-6120.

Table 64. NI 6120 Analog Input Values

Range (V)		Test Point		24-Hour Limits		1-Year Limits	
Minimum	Maximum	Location	Value (V)	Lower Limit (V)	Upper Limit (V)	Lower Limit (V)	Upper Limit (V)
-42	42	Pos FS	41.16	41.086432	41.233568	41.085732	41.234268
-42	42	0	0	-0.008906	0.008906	-0.008906	0.008906
-42	42	Neg FS	-41.16	-41.233568	-41.086432	-41.234268	-41.085732
-20	20	Pos FS	19.6	19.569232	19.630768	19.568899	19.631101
-20	20	0	0	-0.003563	0.003563	-0.003563	0.003563
-20	20	Neg FS	-19.6	-19.630768	-19.569232	-19.631101	-19.568899
-10	10	Pos FS	9.8	9.795013	9.804987	9.794846	9.805154
-10	10	0	0	-0.001783	0.001783	-0.001783	0.001783
-10	10	Neg FS	-9.8	-9.804987	-9.795013	-9.805154	-9.794846
-5	5	Pos FS	4.9	4.897360	4.902640	4.897276	4.902724
-5	5	0	0	-0.000906	0.000906	-0.000906	0.000906
-5	5	Neg FS	-4.9	-4.902640	-4.897360	-4.902724	-4.897276
-2	2	Pos FS	1.96	1.958832	1.961168	1.958801	1.961199
-2	2	0	0	-0.000397	0.000397	-0.000397	0.000397

Table 64. NI 6120 Analog Input Values (Continued)

Range (V)		Test Point		24-Hour Limits		1-Year Limits	
Minimum	Maximum	Location	Value (V)	Lower Limit (V)	Upper Limit (V)	Lower Limit (V)	Upper Limit (V)
-2	2	Neg FS	-1.96	-1.961168	-1.958832	-1.961199	-1.958801
-1	1	Pos FS	0.98	0.978951	0.981049	0.978934	0.981066
-1	1	0	0	-0.000294	0.000294	-0.000294	0.000294
-1	1	Neg FS	-0.98	-0.981049	-0.978951	-0.981066	-0.978934
-0.5	0.5	Pos FS	0.49	0.489316	0.490684	0.489307	0.490693
-0.5	0.5	0	0	-0.000194	0.000194	-0.000194	0.000194
-0.5	0.5	Neg FS	-0.49	-0.490684	-0.489316	-0.490693	-0.489307
-0.2	0.2	Pos FS	0.196	0.195661	0.196339	0.195658	0.196342
-0.2	0.2	0	0	-0.000098	0.000098	-0.000098	0.000098
-0.2	0.2	Neg FS	-0.196	-0.196339	-0.195661	-0.196342	-0.195658

Table 65. NI 6120 Analog Output Values

Range (V)		Test Point		24-Hour Limits		1-Year Limits	
Minimum	Maximum	Location	Value (V)	Lower Limit (V)	Upper Limit (V)	Lower Limit (V)	Upper Limit (V)
-10	10	Pos FS	9.8	9.793128	9.806872	9.792961	9.807039
-10	10	0	0	-0.001864	0.001864	-0.001864	0.001864
-10	10	Neg FS	-9.8	-9.806872	-9.793128	-9.807039	-9.792961

Table 66. NI 6120 Counter Values

Set Point (MHz)	Lower Limit (MHz)	Upper Limit (MHz)
5	4.99950	5.00050

NI 6122/6123 (16-Bit Resolution)

Tables 67 and 68 include values for the PCI-6122, PXI-6122, PCI-6123, and PXI-6123 (analog input only).

Table 67. NI 6122/6123 Analog Input Values

Range (V)		Test Point		24-Hour Limits		2-Year Limits	
Minimum	Maximum	Location	Value (V)	Lower Limit (V)	Upper Limit (V)	Lower Limit (V)	Upper Limit (V)
-10	10	Pos FS	9.95	9.945926	9.954074	9.945647	9.954353
-10	10	0	0	-0.002880	0.002880	-0.002880	0.002880
-10	10	Neg FS	-9.95	-9.954074	-9.945926	-9.954353	-9.945647

Table 67. NI 6122/6123 Analog Input Values (Continued)

Range (V)		Test Point		24-Hour Limits		2-Year Limits	
Minimum	Maximum	Location	Value (V)	Lower Limit (V)	Upper Limit (V)	Lower Limit (V)	Upper Limit (V)
-5	5	Pos FS	4.95	4.947896	4.952104	4.947757	4.952243
-5	5	0	0	-0.001510	0.001510	-0.001510	0.001510
-5	5	Neg FS	-4.95	-4.952104	-4.947896	-4.952243	-4.947757
-2.5	2.5	Pos FS	2.45	2.448836	2.451164	2.448768	2.451232
-2.5	2.5	0	0	-0.000858	0.000858	-0.000858	0.000858
-2.5	2.5	Neg FS	-2.45	-2.451164	-2.448836	-2.451232	-2.448768
-1.25	1.25	Pos FS	1.2	1.199386	1.200614	1.199353	1.200647
-1.25	1.25	0	0	-0.000464	0.000464	-0.000464	0.000464
-1.25	1.25	Neg FS	-1.2	-1.200614	-1.199386	-1.200647	-1.199353

Table 68. NI 6122/6123 Counter Values

Set Point (MHz)	Lower Limit (MHz)	Upper Limit (MHz)
5	4.99950	5.00050

NI PXIe-6124 (16-Bit Resolution)

Tables 69 through 71 include values for the NI PXIe-6124.

Table 69. NI PXIe-6124 Analog Input Values

Range (V)		Test Point		24-Hour Limits		1-Year Limits	
Minimum	Maximum	Location	Value (V)	Lower Limit (V)	Upper Limit (V)	Lower Limit (V)	Upper Limit (V)
-10	10	Pos FS	9.95	9.947151	9.952849	9.946863	9.953137
-10	10	0	0	-0.001217	0.001217	-0.001217	0.001217
-10	10	Neg FS	-9.95	-9.952849	-9.947151	-9.953137	-9.946863
-5	5	Pos FS	4.975	4.973513	4.976487	4.973369	4.976631
-5	5	0	0	-0.000621	0.000621	-0.000621	0.000621
-5	5	Neg FS	-4.975	-4.976487	-4.973513	-4.976631	-4.973369
-2	2	Pos FS	1.99	1.989346	1.990654	1.989289	1.990711
-2	2	0	0	-0.000268	0.000268	-0.000268	0.000268
-2	2	Neg FS	-1.99	-1.990654	-1.989346	-1.990711	-1.989289
-1	1	Pos FS	0.995	0.994638	0.995362	0.994609	0.995391
-1	1	0	0	-0.000149	0.000149	-0.000149	0.000149
-1	1	Neg FS	-0.995	-0.995362	-0.994638	-0.995391	-0.994609

Table 70. NI PXIe-6124 Analog Output Values

Range (V)		Test Point		24-Hour Limits		1-Year Limits	
Minimum	Maximum	Location	Value (V)	Lower Limit (V)	Upper Limit (V)	Lower Limit (V)	Upper Limit (V)
-10	10	Pos FS	9.95	9.946739	9.953261	9.946451	9.953550
-10	10	0	0	-0.001460	0.001460	-0.001460	0.001460
-10	10	Neg FS	-9.95	-9.953261	-9.946739	-9.953550	-9.946451

Table 71. NI PXIe-6124 Counter Values

Set Point (MHz)	Lower Limit (MHz)	Upper Limit (MHz)
5	4.99975	5.00025

NI 6132/6133 (14-Bit Resolution)

Tables 72 and 73 include values for the PCI-6132, PXI-6132, PCI-6133, and PXI-6133 (analog input only).

Table 72. NI 6132/6133 Analog Input Values

Range (V)		Test Point		1-Year Limits	
Minimum	Maximum	Location	Value (V)	Lower Limit (V)	Upper Limit (V)
-10	10	Pos FS	9.8	9.7958	9.8042
-10	10	0	0	-0.0024	0.0024
-10	10	Neg FS	-9.8	-9.8042	-9.7958

Table 72. NI 6132/6133 Analog Input Values (Continued)

Range (V)		Test Point		1-Year Limits	
Minimum	Maximum	Location	Value (V)	Lower Limit (V)	Upper Limit (V)
-5	5	Pos FS	4.9	4.8978	4.9022
-5	5	0	0	-0.0012	0.0012
-5	5	Neg FS	-4.9	-4.9022	-4.8978
-2.5	2.5	Pos FS	2.45	2.44875	2.45125
-2.5	2.5	0	0	-0.00067	0.00067
-2.5	2.5	Neg FS	-2.45	-2.45125	-2.44875
-1.25	1.25	Pos FS	1.225	1.22432	1.22568
-1.25	1.25	0	0	-0.00036	0.00036
-1.25	1.25	Neg FS	-1.225	-1.22568	-1.22432

Table 73. NI 6132/6133 Counter Values

Set Point (MHz)	Lower Limit (MHz)	Upper Limit (MHz)
5	4.99950	5.00050

NI 6143 (16-Bit Resolution)

Tables 74 and 75 include values for the PCI-6143 and PXI-6143 (analog input only).

Table 74. NI 6143 Analog Input Values

Range (V)		Test Point		1-Year Limits	
Minimum	Maximum	Location	Value (V)	Lower Limit (V)	Upper Limit (V)
-5	5	Pos FS	4.95	4.946455	4.953545
-5	5	0	0	-0.000708	0.000708
-5	5	Neg FS	-4.95	-4.953545	-4.946455

Table 75. NI 6143 Counter Values

Set Point (MHz)	Lower Limit (MHz)	Upper Limit (MHz)
5	4.99950	5.00050

X Series Test Limits

NI 6320/6321/6323 (16-Bit Resolution)

Tables 76 through 78 include values for the NI PCIe-6320 (analog input only), NI PCIe-6321, and NI PCIe-6323 X Series MIO devices.

Table 76. NI 6320/6321/6323 Analog Input Values

Range (V)		Test Point		24-Hour Limits		2-Year Limits	
Minimum	Maximum	Location	Value (V)	Lower Limit (V)	Upper Limit (V)	Lower Limit (V)	Upper Limit (V)
-10	10	Pos FS	9.980000	9.978701	9.981299	9.977803	9.982197
-10	10	0.000000	0.000000	-0.000977	0.000977	-0.000977	0.000977
-10	10	Neg FS	-9.980000	-9.981299	-9.978701	-9.982197	-9.977803
-5	5	Pos FS	4.990000	4.989310	4.990690	4.988861	4.991139
-5	5	0.000000	0.000000	-0.000494	0.000494	-0.000494	0.000494
-5	5	Neg FS	-4.990000	-4.990690	-4.989310	-4.991139	-4.988861
-1	1	Pos FS	0.998000	0.997840	0.998160	0.997750	0.998250
-1	1	0.000000	0.000000	-0.000115	0.000115	-0.000115	0.000115
-1	1	Neg FS	-0.998000	-0.998160	-0.997840	-0.998250	-0.997750
-0.2	0.2	Pos FS	0.199600	0.199549	0.199651	0.199531	0.199669
-0.2	0.2	0.000000	0.000000	-0.000036	0.000036	-0.000036	0.000036
-0.2	0.2	Neg FS	-0.199600	-0.199651	-0.199549	-0.199669	-0.199531

Table 77. NI 6321/6323 Analog Output Values

Range (V)		Test Point		24-Hour Limits		2-Year Limits	
Minimum	Maximum	Location	Value (V)	Lower Limit (V)	Upper Limit (V)	Lower Limit (V)	Upper Limit (V)
-10	10	Pos FS	9.980000	9.977630	9.982370	9.976732	9.983268
-10	10	0.000000	0.000000	-0.001858	0.001858	-0.001858	0.001858
-10	10	Neg FS	-9.980000	-9.982370	-9.977630	-9.983268	-9.976732

Table 78. NI 6320/6321/6323 Counter Values

Set Point (MHz)	Lower Limit (MHz)	Upper Limit (MHz)
5	4.99975	5.00025

NI 6341/6343 (16-Bit Resolution)

Tables 79 through 81 include values for the NI PCIe-6341, NI PXIe-6341, NI USB-6341, NI PCIe-6343, and NI USB-6343 X Series MIO devices.

Table 79. NI 6341/6343 Analog Input Values

Range (V)		Test Point		24-Hour Limits		2-Year Limits	
Minimum	Maximum	Location	Value (V)	Lower Limit (V)	Upper Limit (V)	Lower Limit (V)	Upper Limit (V)
-10	10	Pos FS	9.980000	9.978710	9.981290	9.977811	9.982189
-10	10	0.000000	0.000000	-0.000968	0.000968	-0.000968	0.000968
-10	10	Neg FS	-9.980000	-9.981290	-9.978710	-9.982189	-9.977811
-5	5	Pos FS	4.990000	4.989320	4.990680	4.988871	4.991129
-5	5	0.000000	0.000000	-0.000484	0.000484	-0.000484	0.000484
-5	5	Neg FS	-4.990000	-4.990680	-4.989320	-4.991129	-4.988871
-1	1	Pos FS	0.998000	0.997851	0.998149	0.997761	0.998239
-1	1	0.000000	0.000000	-0.000104	0.000104	-0.000104	0.000104
-1	1	Neg FS	-0.998000	-0.998149	-0.997851	-0.998239	-0.997761
-0.2	0.2	Pos FS	0.199600	0.199560	0.199640	0.199542	0.199658
-0.2	0.2	0.000000	0.000000	-0.000025	0.000025	-0.000025	0.000025
-0.2	0.2	Neg FS	-0.199600	-0.199640	-0.199560	-0.199658	-0.199542

Table 80. NI 6341/6343 Analog Output Values

Range (V)		Test Point		24-Hour Limits		2-Year Limits	
Minimum	Maximum	Location	Value (V)	Lower Limit (V)	Upper Limit (V)	Lower Limit (V)	Upper Limit (V)
-10	10	Pos FS	9.980000	9.977630	9.982370	9.976732	9.983268
-10	10	0.000000	0.000000	-0.001858	0.001858	-0.001858	0.001858
-10	10	Neg FS	-9.980000	-9.982370	-9.977630	-9.983268	-9.976732

Table 81. NI 6341/6343 Counter Values

Set Point (MHz)	Lower Limit (MHz)	Upper Limit (MHz)
5	4.99975	5.00025

NI 6345/6351/6353/6355 (16-Bit Resolution)

Tables 82 through 84 include values for the NI PXIe-6345, NI PCIe-6351, NI USB-6351, NI PCIe-6353, NI USB-6353, and NI PXIe-6355 X Series MIO devices.

Table 82. NI 6345/6351/6353/6355 Analog Input Values

Range (V)		Test Point		24-Hour Limits		2-Year Limits	
Minimum	Maximum	Location	Value (V)	Lower Limit (V)	Upper Limit (V)	Lower Limit (V)	Upper Limit (V)
-10	10	Pos FS	9.980000	9.978852	9.981148	9.978483	9.981517
-10	10	0.000000	0.000000	-0.000808	0.000808	-0.000808	0.000808
-10	10	Neg FS	-9.980000	-9.981148	-9.978852	-9.981517	-9.978483

Table 82. NI 6345/6351/6353/6355 Analog Input Values (Continued)

Range (V)		Test Point		24-Hour Limits		2-Year Limits	
Minimum	Maximum	Location	Value (V)	Lower Limit (V)	Upper Limit (V)	Lower Limit (V)	Upper Limit (V)
-5	5	Pos FS	4.990000	4.989391	4.990609	4.989207	4.990793
-5	5	0.000000	0.000000	-0.000404	0.000404	-0.000404	0.000404
-5	5	Neg FS	-4.990000	-4.990609	-4.989391	-4.990793	-4.989207
-2	2	Pos FS	1.996000	1.995750	1.996250	1.995677	1.996323
-2	2	0.000000	0.000000	-0.000168	0.000168	-0.000168	0.000168
-2	2	Neg FS	-1.996000	-1.996250	-1.995750	-1.996323	-1.995677
-1	1	Pos FS	0.998000	0.997858	0.998142	0.997821	0.998179
-1	1	0.000000	0.000000	-0.000091	0.000091	-0.000091	0.000091
-1	1	Neg FS	-0.998000	-0.998142	-0.997858	-0.998179	-0.997821
-0.5	0.5	Pos FS	0.499000	0.498924	0.499076	0.498905	0.499095
-0.5	0.5	0.000000	0.000000	-0.000049	0.000049	-0.000049	0.000049
-0.5	0.5	Neg FS	-0.499000	-0.499076	-0.498924	-0.499095	-0.498905
-0.2	0.2	Pos FS	0.199600	0.199558	0.199642	0.199550	0.199650
-0.2	0.2	0.000000	0.000000	-0.000026	0.000026	-0.000026	0.000026
-0.2	0.2	Neg FS	-0.199600	-0.199642	-0.199558	-0.199650	-0.199550
-0.1	0.1	Pos FS	0.099800	0.099772	0.099828	0.099768	0.099832

Table 82. NI 6345/6351/6353/6355 Analog Input Values (Continued)

Range (V)		Test Point		24-Hour Limits		2-Year Limits	
Minimum	Maximum	Location	Value (V)	Lower Limit (V)	Upper Limit (V)	Lower Limit (V)	Upper Limit (V)
-0.1	0.1	0.000000	0.000000	-0.000019	0.000019	-0.000019	0.000019
-0.1	0.1	Neg FS	-0.099800	-0.099828	-0.099772	-0.099832	-0.099768

Table 83. NI 6345/6351/6353/6355 Analog Output Values

Range (V)		Test Point		24-Hour Limits		2-Year Limits	
Minimum	Maximum	Location	Value (V)	Lower Limit (V)	Upper Limit (V)	Lower Limit (V)	Upper Limit (V)
-10	10	Pos FS	9.980000	9.978481	9.981519	9.978112	9.981888
-10	10	0.000000	0.000000	-0.000990	0.000990	-0.000990	0.000990
-10	10	Neg FS	-9.980000	-9.981519	-9.978481	-9.981888	-9.978112
-5	5	Pos FS	4.990000	4.989251	4.990749	4.989066	4.990934
-5	5	0.000000	0.000000	-0.000495	0.000495	-0.000495	0.000495
-5	5	Neg FS	-4.990000	-4.990749	-4.989251	-4.990934	-4.989066

Table 84. NI 6345/6351/6353/6355 Counter Values

Set Point (MHz)	Lower Limit (MHz)	Upper Limit (MHz)
5	4.99975	5.00025

NI 6346/6349 (16-Bit Resolution)

Tables 85 through 86 include values for the NI PCIe-6346, NI USB-6346, NI PXIe-6349, NI USB-6349 X Series MIO devices.

Table 85. NI 6346/6349 Analog Input Values

Range (V)		Test Point		24-Hour Limits		1-Year Limits	
Minimum	Maximum	Location	Value (V)	Lower Limit (V)	Upper Limit (V)	Lower Limit (V)	Upper Limit (V)
-10	10	Pos FS	9.980000	9.977677	9.982323	9.976779	9.983221
-10	10	0.000000	0.000000	-0.001408	0.001408	-0.001408	0.001408
-10	10	Neg FS	-9.980000	-9.982323	-9.977677	-9.983221	-9.976779
-5	5	Pos FS	4.990000	4.988838	4.991162	4.988389	4.991611
-5	5	0.000000	0.000000	-0.000704	0.000704	-0.000704	0.000704
-5	5	Neg FS	-4.990000	-4.991162	-4.988838	-4.991611	-4.988389
-2	2	Pos FS	1.998000	1.997531	1.998469	1.997351	1.998649
-2	2	0.000000	0.000000	-0.000282	0.000282	-0.000282	0.000282
-2	2	Neg FS	-1.998000	-1.998469	-1.997531	-1.998649	-1.997351
-1	1	Pos FS	0.998000	0.997758	0.998242	0.997668	0.998332
-1	1	0.000000	0.000000	-0.000142	0.000142	-0.000142	0.000142
-1	1	Neg FS	-0.998000	-0.998242	-0.997758	-0.998332	-0.997668

Table 86. NI 6346/6349 Analog Output Values

Range (V)		Test Point		24-Hour Limits		1-Year Limits	
Minimum	Maximum	Location	Value (V)	Lower Limit (V)	Upper Limit (V)	Lower Limit (V)	Upper Limit (V)
-10	10	Pos FS	9.980000	9.977141	9.982859	9.976243	9.983757
-10	10	0.000000	0.000000	-0.001848	0.001848	-0.001848	0.001848
-10	10	Neg FS	-9.980000	-9.982859	-9.977141	-9.983757	-9.976243

Table 87. NI 6346/6349 Counter Values

Set Point (MHz)	Lower Limit (MHz)	Upper Limit (MHz)
5	4.99975	5.00025

NI 6356/6358/6366/6368/6374/6376/6378 (16-Bit Resolution)

Tables 88 through 90 include values for the NI PXIe-6356, NI USB-6356, NI PXIe-6358, NI PXIe-6366, NI USB-6366, NI PXIe-6368, NI PCIe-6374, NI PCIe/PXIe-6376, and NI PXIe-6378 X Series simultaneous MIO devices.

Table 88. NI 6356/6358/6366/6368/6374/6376/6378 Analog Input Values

Range (V)		Test Point		24-Hour Limits		2-Year Limits	
Minimum	Maximum	Location	Value (V)	Lower Limit (V)	Upper Limit (V)	Lower Limit (V)	Upper Limit (V)
-10	10	Pos FS	9.980000	9.978214	9.981786	9.977316	9.982684
-10	10	0.000000	0.000000	-0.000968	0.000968	-0.000968	0.000968
-10	10	Neg FS	-9.980000	-9.981786	-9.978214	-9.982684	-9.977316

Table 88. NI 6356/6358/6366/6368/6374/6376/6378 Analog Input Values (Continued)

Range (V)		Test Point		24-Hour Limits		2-Year Limits	
Minimum	Maximum	Location	Value (V)	Lower Limit (V)	Upper Limit (V)	Lower Limit (V)	Upper Limit (V)
-5	5	Pos FS	4.990000	4.989072	4.990928	4.988623	4.991377
-5	5	0.000000	0.000000	-0.000489	0.000489	-0.000489	0.000489
-5	5	Neg FS	-4.990000	-4.990928	-4.989072	-4.991377	-4.988623
-2	2	Pos FS	1.996000	1.995616	1.996384	1.995437	1.996563
-2	2	0.000000	0.000000	-0.000208	0.000208	-0.000208	0.000208
-2	2	Neg FS	-1.996000	-1.996384	-1.995616	-1.996563	-1.995437
-1	1	Pos FS	0.998000	0.997781	0.998219	0.997692	0.998308
-1	1	0.000000	0.000000	-0.000113	0.000113	-0.000113	0.000113
-1	1	Neg FS	-0.998000	-0.998219	-0.997781	-0.998308	-0.997692

Table 89. NI 6356/6358/6366/6368/6374/6376/6378 Analog Output Values

Range (V)		Test Point		24-Hour Limits		2-Year Limits	
Minimum	Maximum	Location	Value (V)	Lower Limit (V)	Upper Limit (V)	Lower Limit (V)	Upper Limit (V)
-10	10	Pos FS	9.980000	9.977642	9.982358	9.976744	9.983256
-10	10	0.000000	0.000000	-0.001300	0.001300	-0.001300	0.001300
-10	10	Neg FS	-9.980000	-9.982358	-9.977642	-9.983256	-9.976744
-5	5	Pos FS	4.990000	4.988836	4.991164	4.988387	4.991613
-5	5	0.000000	0.000000	-0.000650	0.000650	-0.000650	0.000650
-5	5	Neg FS	-4.990000	-4.991164	-4.988836	-4.991613	-4.988387

Table 90. NI 6356/6358/6366/6368/6374/6376/6378 Counter Values

Set Point (MHz)	Lower Limit (MHz)	Upper Limit (MHz)
5	4.99975	5.00025

NI 6361/6363/6365/6375 (16-Bit Resolution)

Tables 91 through 93 include values for the NI PCIe-6361, NI PXIe-6361, NI USB-6361, NI PCIe-6363, NI PXIe-6363, NI USB-6363, NI PXIe-6365, and NI PXIe-6375 X Series MIO devices.

Table 91. NI 6361/6363/6365/6375 Analog Input Values

Range (V)		Test Point		24-Hour Limits		2-Year Limits	
Minimum	Maximum	Location	Value (V)	Lower Limit (V)	Upper Limit (V)	Lower Limit (V)	Upper Limit (V)
-10	10	Pos FS	9.980000	9.978711	9.981289	9.978342	9.981658
-10	10	0.000000	0.000000	-0.000949	0.000949	-0.000949	0.000949
-10	10	Neg FS	-9.980000	-9.981289	-9.978711	-9.981658	-9.978342
-5	5	Pos FS	4.990000	4.989321	4.990679	4.989136	4.990864
-5	5	0.000000	0.000000	-0.000475	0.000475	-0.000475	0.000475
-5	5	Neg FS	-4.990000	-4.990679	-4.989321	-4.990864	-4.989136
-2	2	Pos FS	1.996000	1.995722	1.996278	1.995648	1.996352
-2	2	0.000000	0.000000	-0.000196	0.000196	-0.000196	0.000196
-2	2	Neg FS	-1.996000	-1.996278	-1.995722	-1.996352	-1.995648
-1	1	Pos FS	0.998000	0.997844	0.998156	0.997807	0.998193
-1	1	0.000000	0.000000	-0.000105	0.000105	-0.000105	0.000105
-1	1	Neg FS	-0.998000	-0.998156	-0.997844	-0.998193	-0.997807
-0.5	0.5	Pos FS	0.499000	0.498917	0.499083	0.498898	0.499102

Table 91. NI 6361/6363/6365/6375 Analog Input Values (Continued)

Range (V)		Test Point		24-Hour Limits		2-Year Limits	
Minimum	Maximum	Location	Value (V)	Lower Limit (V)	Upper Limit (V)	Lower Limit (V)	Upper Limit (V)
-0.5	0.5	0.000000	0.000000	-0.000056	0.000056	-0.000056	0.000056
-0.5	0.5	Neg FS	-0.499000	-0.499083	-0.498917	-0.499102	-0.498898
-0.2	0.2	Pos FS	0.199600	0.199555	0.199645	0.199547	0.199653
-0.2	0.2	0.000000	0.000000	-0.000029	0.000029	-0.000029	0.000029
-0.2	0.2	Neg FS	-0.199600	-0.199645	-0.199555	-0.199653	-0.199547
-0.1	0.1	Pos FS	0.099800	0.099771	0.099829	0.099767	0.099833
-0.1	0.1	0.000000	0.000000	-0.000020	0.000020	-0.000020	0.000020
-0.1	0.1	Neg FS	-0.099800	-0.099829	-0.099771	-0.099833	-0.099767

Table 92. NI 6361/6363/6365/6375 Analog Output Values

Range (V)		Test Point		24-Hour Limits		2-Year Limits	
Minimum	Maximum	Location	Value (V)	Lower Limit (V)	Upper Limit (V)	Lower Limit (V)	Upper Limit (V)
-10	10	Pos FS	9.980000	9.978481	9.981519	9.978112	9.981888
-10	10	0.000000	0.000000	-0.000990	0.000990	-0.000990	0.000990
-10	10	Neg FS	-9.980000	-9.981519	-9.978481	-9.981888	-9.978112
-5	5	Pos FS	4.990000	4.989251	4.990749	4.989066	4.990934
-5	5	0.000000	0.000000	-0.000495	0.000495	-0.000495	0.000495
-5	5	Neg FS	-4.990000	-4.990749	-4.989251	-4.990934	-4.989066

Table 93. NI 6361/6363/6365/6375 Counter Values

Set Point (MHz)	Lower Limit (MHz)	Upper Limit (MHz)
5	4.99975	5.00025

NI 6386 (16-Bit Resolution)

Tables 94 through 96 include values for the PXIe-6386 X Series SMIO device.

Table 94. NI PXIe-6386 Analog Input Values

Range (V)		Test Point		24-Hour Limits		2-Year Limits	
Minimum	Maximum	Location	Value (V)	Lower Limit (V)	Upper Limit (V)	Lower Limit (V)	Upper Limit (V)
-10	10	Pos FS	9.980000	9.978783	9.981217	9.978294	9.981706
-10	10	0.000000	0.000000	-0.001028	0.001028	-0.001028	0.001028
-10	10	Neg FS	-9.980000	-9.981217	-9.978783	-9.981706	-9.978294
-5	5	Pos FS	4.990000	4.989351	4.990649	4.989106	4.990894
-5	5	0.000000	0.000000	-0.000520	0.000520	-0.000520	0.000520
-5	5	Neg FS	-4.990000	-4.990649	-4.989351	-4.990894	-4.989106
-2	2	Pos FS	1.996000	1.995735	1.996265	1.995637	1.996363
-2	2	0.000000	0.000000	-0.000213	0.000213	-0.000213	0.000213
-2	2	Neg FS	-1.996000	-1.996265	-1.995735	-1.996363	-1.995637
-1	1	Pos FS	0.998000	0.997852	0.998148	0.997803	0.998197
-1	1	0.000000	0.000000	-0.000112	0.000112	-0.000112	0.000112
-1	1	Neg FS	-0.998000	-0.998148	-0.997852	-0.998197	-0.997803

Table 95. NI PXIe-6386 Analog Output Values

Range (V)		Test Point		24-Hour Limits		2-Year Limits	
Minimum	Maximum	Location	Value (V)	Lower Limit (V)	Upper Limit (V)	Lower Limit (V)	Upper Limit (V)
-10	10	Pos FS	9.980000	9.977592	9.982408	9.976744	9.983256
-10	10	0.000000	0.000000	-0.001300	0.001300	-0.001300	0.001300
-10	10	Neg FS	-9.980000	-9.982408	-9.977592	-9.983256	-9.976744
-5	5	Pos FS	4.990000	4.988811	4.991189	4.988387	4.991613
-5	5	0.000000	0.000000	-0.000650	0.000650	-0.000650	0.000650
-5	5	Neg FS	-4.990000	-4.991189	-4.988811	-4.991613	-4.988387

Table 96. NI PXIe-6386 Counter Values

Set Point (MHz)	Lower Limit (MHz)	Upper Limit (MHz)
5	4.99975	5.00025

NI 6396 (18-Bit Resolution)

Tables 97 through 99 include values for the PXIe-6396 X Series SMIO device.

Table 97. NI PXIe-6396 Analog Input Values

Range (V)		Test Point		24-Hour Limits		2-Year Limits	
Minimum	Maximum	Location	Value (V)	Lower Limit (V)	Upper Limit (V)	Lower Limit (V)	Upper Limit (V)
-10	10	Pos FS	9.980000	9.978783	9.981217	9.978294	9.981706
-10	10	0.000000	0.000000	-0.001027	0.001027	-0.001027	0.001027
-10	10	Neg FS	-9.980000	-9.981217	-9.978783	-9.981706	-9.978294
-5	5	Pos FS	4.990000	4.989351	4.990649	4.989107	4.990893
-5	5	0.000000	0.000000	-0.000519	0.000519	-0.000519	0.000519
-5	5	Neg FS	-4.990000	-4.990649	-4.989351	-4.990893	-4.989107
-2	2	Pos FS	1.996000	1.995736	1.996264	1.995638	1.996362
-2	2	0.000000	0.000000	-0.000212	0.000212	-0.000212	0.000212
-2	2	Neg FS	-1.996000	-1.996264	-1.995736	-1.996362	-1.995638
-1	1	Pos FS	0.998000	0.997853	0.998147	0.997804	0.998196
-1	1	0.000000	0.000000	-0.000112	0.000112	-0.000112	0.000112
-1	1	Neg FS	-0.998000	-0.998147	-0.997853	-0.998196	-0.997804

Table 98. NI PXIe-6396 Analog Output Values

Range (V)		Test Point		24-Hour Limits		2-Year Limits	
Minimum	Maximum	Location	Value (V)	Lower Limit (V)	Upper Limit (V)	Lower Limit (V)	Upper Limit (V)
-10	10	Pos FS	9.980000	9.977592	9.982408	9.976744	9.983256
-10	10	0.000000	0.000000	-0.001300	0.001300	-0.001300	0.001300
-10	10	Neg FS	-9.980000	-9.982408	-9.977592	-9.983256	-9.976744
-5	5	Pos FS	4.990000	4.988811	4.991189	4.988387	4.991613
-5	5	0.000000	0.000000	-0.000650	0.000650	-0.000650	0.000650
-5	5	Neg FS	-4.990000	-4.991189	-4.988811	-4.991613	-4.988387

Table 99. NI PXIe-6396 Counter Values

Set Point (MHz)	Lower Limit (MHz)	Upper Limit (MHz)
5	4.99975	5.00025

Worldwide Support and Services

The National Instruments website is your complete resource for technical support. At ni.com/support you have access to everything from troubleshooting and application development self-help resources to email and phone assistance from NI Application Engineers.

Visit ni.com/services for NI Factory Installation Services, repairs, extended warranty, and other services.

Visit ni.com/register to register your National Instruments product. Product registration facilitates technical support and ensures that you receive important information updates from NI.

National Instruments corporate headquarters is located at 11500 North Mopac Expressway, Austin, Texas, 78759-3504. National Instruments also has offices located around the world. For telephone support in the United States, create your service request at ni.com/support or dial 1 866 ASK MYNI (275 6964). For telephone support outside the United States, visit the Worldwide Offices section of ni.com/niglobal to access the branch office websites, which provide up-to-date contact information, support phone numbers, email addresses, and current events.

Information is subject to change without notice. Refer to the *NI Trademarks and Logo Guidelines* at ni.com/trademarks for more information on NI trademarks. Other product and company names mentioned herein are trademarks or trade names of their respective companies. For patents covering NI products/technology, refer to the appropriate location: **Help»Patents** in your software, the `patents.txt` file on your media, or the *National Instruments Patents Notice* at ni.com/patents. You can find information about end-user license agreements (EULAs) and third-party legal notices in the readme file for your NI product. Refer to the *Export Compliance Information* at ni.com/legal/export-compliance for the NI global trade compliance policy and how to obtain relevant HTS codes, ECCNs, and other import/export data. NI MAKES NO EXPRESS OR IMPLIED WARRANTIES AS TO THE ACCURACY OF THE INFORMATION CONTAINED HEREIN AND SHALL NOT BE LIABLE FOR ANY ERRORS. U.S. Government Customers: The data contained in this manual was developed at private expense and is subject to the applicable limited rights and restricted data rights as set forth in FAR 52.227-14, DFAR 252.227-7014, and DFAR 252.227-7015.

© 2004–2019 National Instruments. All rights reserved.