

## COMPREHENSIVE SERVICES

We offer competitive repair and calibration services, as well as easily accessible documentation and free downloadable resources.

## SELL YOUR SURPLUS

We buy new, used, decommissioned, and surplus parts from every NI series. We work out the best solution to suit your individual needs.

 Sell For Cash    Get Credit    Receive a Trade-In Deal

## OBSOLETE NI HARDWARE IN STOCK & READY TO SHIP

We stock **New**, **New Surplus**, **Refurbished**, and **Reconditioned** NI Hardware.



*Bridging the gap between the manufacturer and your legacy test system.*

 1-800-915-6216

 [www.apexwaves.com](http://www.apexwaves.com)

 [sales@apexwaves.com](mailto:sales@apexwaves.com)

*All trademarks, brands, and brand names are the property of their respective owners.*

**Request a Quote**

 **CLICK HERE**

**PXIe-6366**


## DEVICE SPECIFICATIONS

# NI 6366

X Series Data Acquisition 2 MS/s/ch, 8 AI, 24 DIO, 2 AO

The following specifications are typical at 25 °C, unless otherwise noted. For more information about the NI 6366, refer to the *X Series User Manual* available from [ni.com/manuals](http://ni.com/manuals).

## Analog Input

Number of channels	8 differential
ADC resolution	16 bits
DNL	No missing codes guaranteed
INL	Refer to the <i>AI Absolute Accuracy</i> section.
Sample rate	
Single channel maximum	2.00 MS/s
Minimum	No minimum
Timing resolution	10 ns
Timing accuracy	50 ppm of sample rate
Input coupling	DC
Input range	±1 V, ±2 V, ±5 V, ±10 V
Maximum working voltage for all analog inputs	
Positive input (AI+)	±11 V for all ranges, Measurement Category I
Negative input (AI-)	±11 V for all ranges, Measurement Category I
 <b>Caution</b>	Do not use for measurements within Categories II, III, and IV.
CMRR (at 60 Hz)	75 dB
Bandwidth	1 MHz
THD	-80 dBFS

## Input impedance

Device on	
AI+ to AI GND	>100 G $\Omega$ in parallel with 100 pF
AI- to AI GND	>100 G $\Omega$ in parallel with 100 pF
Device off	
AI+ to AI GND	2 k $\Omega$
AI- to AI GND	2 k $\Omega$
Input bias current	$\pm 10$ pA
Crosstalk (at 100 kHz)	
Adjacent channels	-80 dB
Non-adjacent channels	-100 dB
Input FIFO size	
PXIe	8,182 samples shared among channels used
USB (32 MS)	32 MS shared among channels used
USB (64 MS)	64 MS shared among channels used
Data transfers	
PXIe	DMA (scatter-gather), programmed I/O
USB	USB Signal Stream, programmed I/O
Overvoltage protection for all analog input channels	
Device on	$\pm 36$ V
Device off	$\pm 15$ V
Input current during overvoltage conditions	$\pm 20$ mA max/AI pin

## Analog Triggers

Number of triggers	1
Source	AI <0..7>, APFI 0
Functions	Start Trigger, Reference Trigger, Pause Trigger, Sample Clock, Sample Clock Timebase
Source level	
AI <0..7>	$\pm$ Full scale
APFI 0	$\pm 10$ V
Resolution	16 bits

Modes	Analog edge triggering, analog edge triggering with hysteresis, and analog window triggering
Bandwidth (-3 dB)	
AI <0..7>	3.4 MHz
APFI 0	3.9 MHz
Accuracy	±1% of range
APFI 0 characteristics	
Input impedance	10 kΩ
Coupling	DC
Protection, power on	±30 V
Protection, power off	±15 V

## AI Absolute Accuracy

**Table 1.** AI Absolute Accuracy

Nominal Range Positive Full Scale	Nominal Range Negative Full Scale	Residual Gain Error (ppm of Reading)	Offset Tempco (ppm of Range/°C)	Random Noise, $\sigma$ ( $\mu\text{Vrms}$ )	Absolute Accuracy at Full Scale ( $\mu\text{V}$ )
10	-10	114	35	252	2,688
5	-5	120	36	134	1,379
2	-2	120	42	71	564
1	-1	138	50	61	313



**Note** For more information about absolute accuracy at full scale, refer to the [AI Absolute Accuracy Example](#) section.

Gain tempco	8 ppm/°C
Reference tempco	5 ppm/°C
Residual offset error	15 ppm of range
INL error	46 ppm of range



**Note** Accuracies listed are valid for up to two years from the device external calibration.

## AI Absolute Accuracy Equation

$AbsoluteAccuracy = Reading \cdot (GainError) + Range \cdot (OffsetError) + NoiseUncertainty$

$GainError = ResidualGainError + GainTempco \cdot (TempChangeFromLastInternalCal) + ReferenceTempco \cdot (TempChangeFromLastExternalCal)$

$OffsetError = ResidualOffsetError + OffsetTempco \cdot (TempChangeFromLastInternalCal) + INLError$

$NoiseUncertainty = \frac{Random\ Noise \cdot 3}{\sqrt{10,000}}$  for a coverage factor of  $3\sigma$  and averaging 10,000 points.

## AI Absolute Accuracy Example

Absolute accuracy at full scale on the analog input channels is determined using the following assumptions:

- $TempChangeFromLastExternalCal = 10\text{ }^{\circ}\text{C}$
- $TempChangeFromLastInternalCal = 1\text{ }^{\circ}\text{C}$
- $number\_of\_readings = 10,000$
- $CoverageFactor = 3\sigma$

For example, on the 10 V range, the absolute accuracy at full scale is as follows:

$GainError = 114\text{ ppm} + 8\text{ ppm} \cdot 1 + 5\text{ ppm} \cdot 10 = 172\text{ ppm}$

$OffsetError = 15\text{ ppm} + 35\text{ ppm} \cdot 1 + 46\text{ ppm} = 96\text{ ppm}$

$Noise\ Uncertainty = \frac{252\ \mu\text{V} \cdot 3}{\sqrt{10,000}} = 7.6\ \mu\text{V}$

$AbsoluteAccuracy = 10\text{ V} \cdot (GainError) + 10\text{ V} \cdot (OffsetError) + NoiseUncertainty = 2688\ \mu\text{V}$

## Analog Output

Number of channels	2
DAC resolution	16 bits
DNL	$\pm 1$ LSB, max
Monotonicity	16 bit guaranteed
Accuracy	Refer to the <a href="#">AO Absolute Accuracy</a> section.
Maximum update rate (simultaneous)	
1 channel	3.3 MS/s
2 channels	3.3 MS/s
Minimum update rate	No minimum
Timing accuracy	50 ppm of sample rate

Timing resolution	10 ns
Output range	$\pm 10$ V, $\pm 5$ V, $\pm$ external reference on APFI 0
Output coupling	DC
Output impedance	0.4 $\Omega$
Output current drive	$\pm 5$ mA
Overdrive protection	$\pm 25$ V
Overdrive current	10 mA
Power-on state	$\pm 5$ mV
Power on/off glitch	
PXIe	1.5 V peak for 200 ms
USB	1.5 V peak for 200 ms, typical behavior <sup>1</sup>
Output FIFO size	8,191 samples shared among channels used
Data transfers	
PXIe	DMA (scatter-gather), programmed I/O
USB	USB Signal Stream, programmed I/O
AO waveform modes	Non-periodic waveform, periodic waveform regeneration mode from onboard FIFO, periodic waveform regeneration from host buffer including dynamic update
Settling time, full-scale step, 15 ppm (1 LSB)	2 $\mu$ s
Slew rate	20 V/ $\mu$ s
Glitch energy at midscale transition, $\pm 10$ V range	6 nV $\cdot$ s

## External Reference

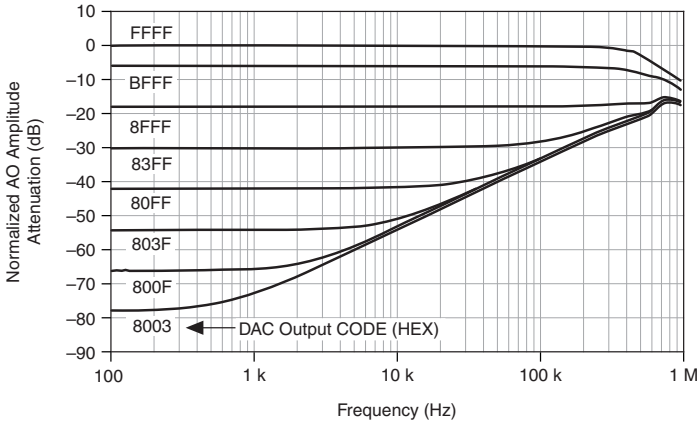
### APFI 0 characteristics

Input impedance	10 k $\Omega$
Coupling	DC
Protection, device on	$\pm 30$ V
Protection, device off	$\pm 15$ V

<sup>1</sup> Time period may be longer due to host system USB performance. Time period will be longer during firmware updates.

Range	±11 V
Slew rate	±20 V/μs

**Figure 1.** Analog Output External Reference Bandwidth



## AO Absolute Accuracy

Absolute accuracy at full-scale numbers is valid immediately following self calibration and assumes the device is operating within 10 °C of the last external calibration.

**Table 2.** AO Absolute Accuracy

Nominal Range Positive Full Scale	Nominal Range Negative Full Scale	Residual Gain Error (ppm of Reading)	Gain Tempco (ppm/°C)	Reference Tempco (ppm/°C)	Residual Offset Error (ppm of Range)	Offset Tempco (ppm of Range/°C)	INL Error (ppm of Range)	Absolute Accuracy at Full Scale (μV)
10	-10	129	17	5	65	1	64	3,256
5	-5	135	8	5	65	1	64	1,616



**Note** Accuracies listed are valid for up to two years from the device external calibration.

## AO Absolute Accuracy Equation

$$\text{AbsoluteAccuracy} = \text{OutputValue} \cdot (\text{GainError}) + \text{Range} \cdot (\text{OffsetError})$$

$$\text{GainError} = \text{ResidualGainError} + \text{GainTempco} \cdot (\text{TempChangeFromLastInternalCal}) + \text{ReferenceTempco} \cdot (\text{TempChangeFromLastExternalCal})$$

$$\text{OffsetError} = \text{ResidualOffsetError} + \text{OffsetTempco} \cdot (\text{TempChangeFromLastInternalCal}) + \text{INLError}$$

# Digital I/O/PFI

## Static Characteristics

Number of channels	24 total, 8 (P0.<0..7>), 16 (PFI <0..7>/P1, PFI <8..15>/P2)
Ground reference	D GND
Direction control	Each terminal individually programmable as input or output
Pull-down resistor	50 k $\Omega$ typical, 20 k $\Omega$ minimum
Input voltage protection	$\pm 20$ V on up to two pins



**Caution** Stresses beyond those listed under the *Input voltage protection* specification may cause permanent damage to the device.

## Waveform Characteristics (Port 0 Only)

Terminals used	Port 0 (P0.<0..7>)
Port/sample size	Up to 8 bits
Waveform generation (DO) FIFO	2,047 samples
Waveform acquisition (DI) FIFO	255 samples
DI Sample Clock frequency	
PXIe	0 to 10 MHz, system and bus activity dependent
USB	0 to 1 MHz, system and bus activity dependent
DO Sample Clock frequency	
PXIe	
Regenerate from FIFO	0 to 10 MHz
Streaming from memory	0 to 10 MHz, system and bus activity dependent
USB	
Regenerate from FIFO	0 to 10 MHz
Streaming from memory	0 to 1 MHz, system and bus activity dependent
Data transfers	
PXIe	DMA (scatter-gather), programmed I/O
USB	USB Signal Stream, programmed I/O
Digital line filter settings	160 ns, 10.24 $\mu$ s, 5.12 ms, disable



## PFI/Port 1/Port 2 Functionality

Functionality	Static digital input, static digital output, timing input, timing output
Timing output sources	Many AI, AO, counter, DI, DO timing signals
Debounce filter settings	90 ns, 5.12 $\mu$ s, 2.56 ms, custom interval, disable; programmable high and low transitions; selectable per input

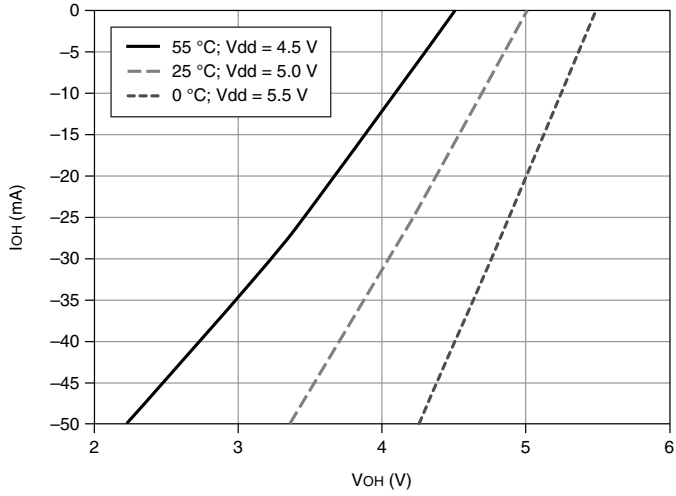
## Recommended Operating Conditions

Input high voltage ( $V_{IH}$ )	
Minimum	2.2 V
Maximum	5.25 V
Input low voltage ( $V_{IL}$ )	
Minimum	0 V
Maximum	0.8 V
Output high current ( $I_{OH}$ )	
P0.<0..7>	-24 mA maximum
PFI <0..15>/P1/P2	-16 mA maximum
Output low current ( $I_{OL}$ )	
P0.<0..7>	24 mA maximum
PFI <0..15>/P1/P2	16 mA maximum

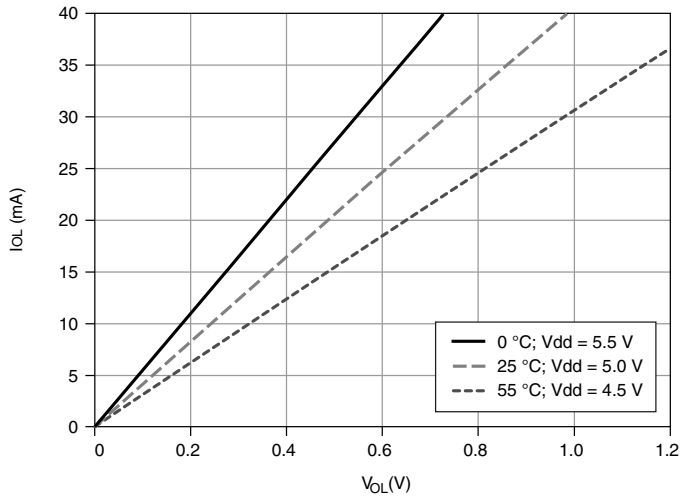
## Digital I/O Characteristics

Positive-going threshold ( $V_{T+}$ )	2.2 V maximum
Negative-going threshold ( $V_{T-}$ )	0.8 V minimum
Delta VT hysteresis ( $V_{T+} - V_{T-}$ )	0.2 V minimum
$I_{IL}$ input low current ( $V_{IN} = 0$ V)	-10 $\mu$ A maximum
$I_{IH}$ input high current ( $V_{IN} = 5$ V)	250 $\mu$ A maximum

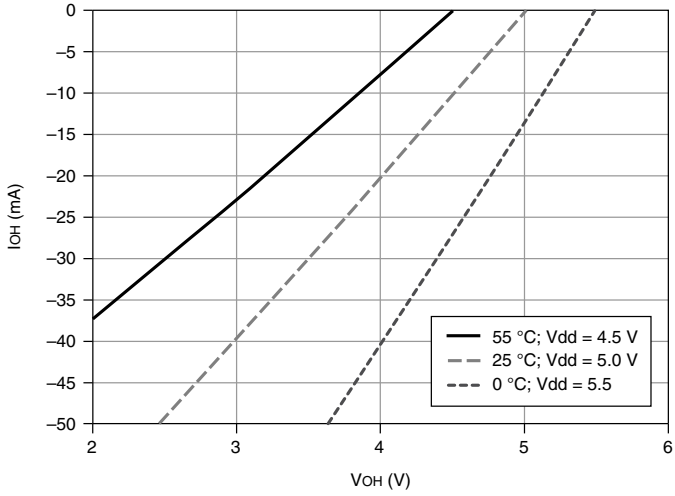
**Figure 2.** P0.<0..7>:  $I_{OH}$  versus  $V_{OH}$



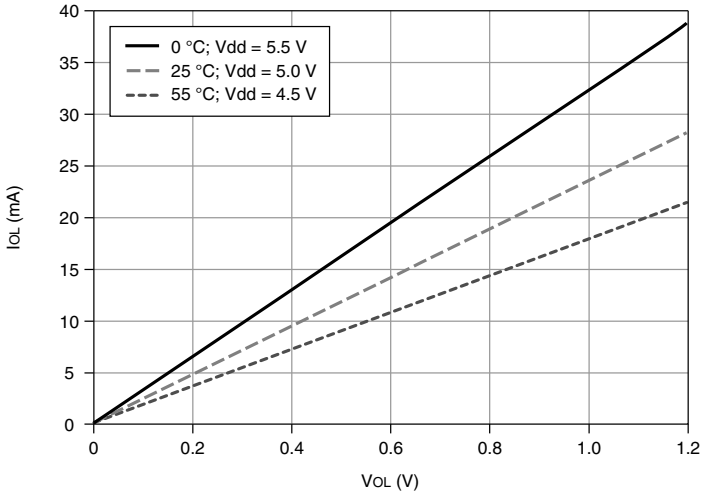
**Figure 3.** P0.<0..7>:  $I_{OL}$  versus  $V_{OL}$



**Figure 4.** PFI <0..15>/P1/P2:  $I_{OH}$  versus  $V_{OH}$



**Figure 5.** PFI <0..15>/P1/P2:  $I_{OL}$  versus  $V_{OL}$



## General-Purpose Counters

Number of counter/timers	4
Resolution	32 bits

Counter measurements	Edge counting, pulse, pulse width, semi-period, period, two-edge separation
Position measurements	X1, X2, X4 quadrature encoding with Channel Z reloading; two-pulse encoding
Output applications	Pulse, pulse train with dynamic updates, frequency division, equivalent time sampling
Internal base clocks	100 MHz, 20 MHz, 100 kHz
External base clock frequency	
PXIe	0 MHz to 25 MHz; 0 MHz to 100 MHz on PXIe_DSTAR<A,B>
USB	0 MHz to 25 MHz
Base clock accuracy	50 ppm
Inputs	Gate, Source, HW_Arm, Aux, A, B, Z, Up_Down, Sample Clock
Routing options for inputs	
PXIe	Any PFI, PXIe_DSTAR<A,B>, PXI_TRIG, PXI_STAR, analog trigger, many internal signals
USB	Any PFI, analog trigger, many internal signals
FIFO	127 samples per counter
Data transfers	
PXIe	Dedicated scatter-gather DMA controller for each counter/timer, programmed I/O
USB	USB Signal Stream, programmed I/O

## Frequency Generator

Number of channels	1
Base clocks	20 MHz, 10 MHz, 100 kHz
Divisors	1 to 16
Base clock accuracy	50 ppm

Output can be available on any PFI terminal.

## Phase-Locked Loop (PLL)

Number of PLLs	1
----------------	---

**Table 3.** Reference Clock Locking Frequencies

Reference Signal	PXI Express Locking Input Frequency (MHz)	USB Locking Input Frequency (MHz)
PXIe_DSTAR<A,B>	10, 20, 100	—
PXI_STAR	10, 20	—
PXIe_CLK100	100	—
PXI_TRIG <0..7>	10, 20	—
PFI <0..15>	10, 20	10

Output of PLL 100 MHz Timebase; other signals derived from 100 MHz Timebase including 20 MHz and 100 kHz Timebases

## External Digital Triggers

### Source

PXIe	Any PFI, PXIe_DSTAR<A,B>, PXI_TRIG, PXI_STAR
------	----------------------------------------------

USB	Any PFI
-----	---------

Polarity	Software-selectable for most signals
----------	--------------------------------------

Analog input function	Start Trigger, Reference Trigger, Pause Trigger, Sample Clock, Sample Clock Timebase
-----------------------	--------------------------------------------------------------------------------------

Analog output function	Start Trigger, Pause Trigger, Sample Clock, Sample Clock Timebase
------------------------	-------------------------------------------------------------------

Counter/timer functions	Gate, Source, HW_Arm, Aux, A, B, Z, Up_Down, Sample Clock
-------------------------	-----------------------------------------------------------

Digital waveform generation (DO) function	Start Trigger, Pause Trigger, Sample Clock, Sample Clock Timebase
-------------------------------------------	-------------------------------------------------------------------

Digital waveform acquisition (DI) function	Start Trigger, Reference Trigger, Pause Trigger, Sample Clock, Sample Clock Timebase
--------------------------------------------	--------------------------------------------------------------------------------------

# Device-to-Device Trigger Bus

## Input source

PXIe	PXI_TRIG <0..7>, PXI_STAR, PXIe_DSTAR<A,B>
USB	None

## Output destination

PXIe	PXI_TRIG <0..7>, PXIe_DSTARC
USB	None

## Output selections

10 MHz Clock, frequency generator output, many internal signals

## Debounce filter settings

90 ns, 5.12  $\mu$ s, 2.56 ms, custom interval, disable; programmable high and low transitions; selectable per input

# Bus Interface

## PXIe

Form factor	x1 PXI Express peripheral module, specification rev 1.0 compliant
Slot compatibility	x1 and x4 PXI Express or PXI Express hybrid slots
DMA channels	8, can be used for analog input, analog output, digital input, digital output, counter/timer 0, counter/timer 1, counter/timer 2, counter/timer 3

All PXIe devices may be installed in PXI Express slots or PXI Express hybrid slots.

## USB

USB compatibility	USB 2.0 Hi-Speed or full-speed <sup>2</sup>
USB Signal Stream	8, can be used for analog input, analog output, digital input, digital output, counter/timer 0, counter/timer 1, counter/timer 2, counter/timer 3

<sup>2</sup> Operating on a full-speed bus results in lower performance and you might not be able to achieve maximum sampling/update rates.

# Power Requirements

---



**Caution** The protection provided by the device can be impaired if the device is used in a manner not described in the *X Series User Manual*.

---

## PXIe

+3.3 V	4.75 W
+12 V	15.6 W

---

## USB

Power supply requirements	11 to 30 VDC, 30 W, 2 positions 3.5 mm pitch pluggable screw terminal with screw locks similar to Phoenix Contact MC 1,5/2-STF-3,5 BK
Power input mating connector	Phoenix Contact MC 1,5/2-GF-3,5 BK or equivalent

---



**Caution** The USB device must be powered with an NI offered AC adapter or a National Electric Code (NEC) Class 2 DC source that meets the power requirements for the device and has the appropriate safety certification marks for country of use.

---

# Current Limits

---



**Note** Exceeding the current limits may cause unpredictable device behavior.

PXIe, +5 V terminal (connector 0)	1 A max <sup>3</sup>
USB, +5 V terminal	1 A max <sup>3</sup>

---

# Physical Characteristics

---

PXIe printed circuit board dimensions	Standard 3U PXI
USB enclosure dimensions (includes connectors)	
Mass termination	18.5 × 17.3 × 3.6 cm (7.3 × 6.8 × 1.4 in.)
Screw terminal	26.4 × 17.3 × 3.6 cm (10.4 × 6.8 × 1.4 in.)
BNC	20.3 × 18.5 × 6.8 cm (8.0 × 7.3 × 2.7 in.)

---

<sup>3</sup> Has a self-resetting fuse that opens when current exceeds this specification.

## Weight

PXI	168 g (5.9 oz)
USB Mass Termination	967 g (2 lb 2.1 oz)
USB Screw Terminal	1.428 kg (3 lb 2.3 oz)
USB BNC	1.536 kg (3 lb 6.2 oz)

## I/O connector

PXIe	1 68-pin VHDCI
USB Mass Termination	1 68-pin VHDCI
USB Screw Terminal	64 screw terminals
USB BNC	20 BNCs and 30 screw terminals

**Table 4.** PXIe and USB Mass Termination Mating Connectors

Manufacturer, Part Number	Description
MOLEX 71430-0011	68-Pos Right Angle Single Stack PCB-Mount VHDCI (Receptacle)
MOLEX 74337-0016	68-Pos Right Angle Dual Stack PCB-Mount VHDCI (Receptacle)
MOLEX 71425-3001	68-Pos Offset IDC Cable Connector (Plug) (SHC68-*)

USB screw terminal/BNC screw terminal wiring      16-24 AWG

## Calibration

Recommended warm-up time	15 minutes
Calibration interval	2 years

## Maximum Working Voltage

*Maximum working voltage* refers to the signal voltage plus the common-mode voltage.

Channel to earth      11 V, Measurement Category I



**Caution** Do not use for measurements within Categories II, III, or IV.



# Shock and Vibration

---

Operational shock	30 g peak, half-sine, 11 ms pulse (Tested in accordance with IEC 60068-2-27. Test profile developed in accordance with MIL-PRF-28800F.)
Random vibration	
Operating	5 to 500 Hz, 0.3 g <sub>rms</sub>
Nonoperating	5 to 500 Hz, 2.4 g <sub>rms</sub> (Tested in accordance with IEC 60068-2-64. Nonoperating test profile exceeds the requirements of MIL-PRF-28800F, Class 3.)

# Environmental

---

Operating temperature	
PXIe	0 to 55 °C
USB	0 to 45 °C
Storage temperature	-40 to 70 °C
Operating humidity	10 to 90% RH, noncondensing
Storage humidity	5 to 95% RH, noncondensing
Pollution Degree	2
Maximum altitude	2,000 m

Indoor use only.

# Safety

---

This product is designed to meet the requirements of the following electrical equipment safety standards for measurement, control, and laboratory use:

- IEC 61010-1, EN 61010-1
- UL 61010-1, CSA 61010-1



**Note** For UL and other safety certifications, refer to the product label or the [Online Product Certification](#) section.

# Electromagnetic Compatibility

---

This product meets the requirements of the following EMC standards for electrical equipment for measurement, control, and laboratory use:

- EN 61326-1 (IEC 61326-1): Class A emissions; Basic immunity
- EN 55011 (CISPR 11): Group 1, Class A emissions
- EN 55022 (CISPR 22): Class A emissions
- EN 55024 (CISPR 24): Immunity
- AS/NZS CISPR 11: Group 1, Class A emissions
- AS/NZS CISPR 22: Class A emissions
- FCC 47 CFR Part 15B: Class A emissions
- ICES-001: Class A emissions



**Note** In the United States (per FCC 47 CFR), Class A equipment is intended for use in commercial, light-industrial, and heavy-industrial locations. In Europe, Canada, Australia and New Zealand (per CISPR 11) Class A equipment is intended for use only in heavy-industrial locations.



**Note** Group 1 equipment (per CISPR 11) is any industrial, scientific, or medical equipment that does not intentionally generate radio frequency energy for the treatment of material or inspection/analysis purposes.



**Note** For EMC declarations and certifications, and additional information, refer to the [Online Product Certification](#) section.

## CE Compliance

---

This product meets the essential requirements of applicable European Directives, as follows:

- 2014/35/EU; Low-Voltage Directive (safety)
- 2014/30/EU; Electromagnetic Compatibility Directive (EMC)

## Online Product Certification

---

Refer to the product Declaration of Conformity (DoC) for additional regulatory compliance information. To obtain product certifications and the DoC for this product, visit [ni.com/certification](https://ni.com/certification), search by model number or product line, and click the appropriate link in the Certification column.

# Environmental Management

---

NI is committed to designing and manufacturing products in an environmentally responsible manner. NI recognizes that eliminating certain hazardous substances from our products is beneficial to the environment and to NI customers.

For additional environmental information, refer to the *Minimize Our Environmental Impact* web page at [ni.com/environment](https://ni.com/environment). This page contains the environmental regulations and directives with which NI complies, as well as other environmental information not included in this document.

## Waste Electrical and Electronic Equipment (WEEE)



**EU Customers** At the end of the product life cycle, all NI products must be disposed of according to local laws and regulations. For more information about how to recycle NI products in your region, visit [ni.com/environment/weee](https://ni.com/environment/weee).

## 电子信息产品污染控制管理办法（中国 RoHS）



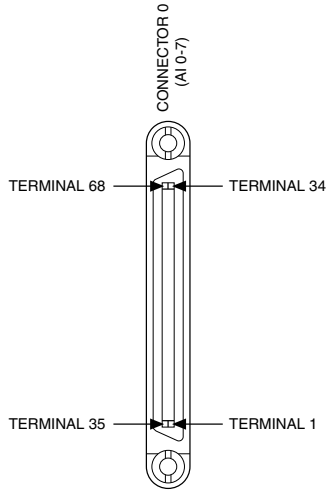
**中国客户** National Instruments 符合中国电子信息产品中限制使用某些有害物质指令 (RoHS)。关于 National Instruments 中国 RoHS 合规性信息，请登录 [ni.com/environment/rohs\\_china](https://ni.com/environment/rohs_china)。(For information about China RoHS compliance, go to [ni.com/environment/rohs\\_china](https://ni.com/environment/rohs_china).)

# Device Pinouts

**Figure 6. NI PXIe-6366 Pinout**

AI 0+	68	34	AI 0-
AI 0 GND	67	33	AI 1+
AI 1-	66	32	AI 1 GND
AI 2+	65	31	AI 2-
AI 2 GND	64	30	AI 3+
AI 3-	63	29	AI 3 GND
NC	62	28	AI 4+
AI 4-	61	27	AI 4 GND
AI 5+	60	26	AI 5-
AI 5 GND	59	25	AI 6+
AI 6-	58	24	AI 6 GND
AI 7+	57	23	AI 7-
AI 7 GND	56	22	AO 0
AO GND	55	21	AO 1
AO GND	54	20	APFI 0
D GND	53	19	P0.4
P0.0	52	18	D GND
P0.5	51	17	P0.1
D GND	50	16	P0.6
P0.2	49	15	D GND
P0.7	48	14	+5 V
P0.3	47	13	D GND
PFI 11/P2.3	46	12	D GND
PFI 10/P2.2	45	11	PFI 0/P1.0
D GND	44	10	PFI 1/P1.1
PFI 2/P1.2	43	9	D GND
PFI 3/P1.3	42	8	+5 V
PFI 4/P1.4	41	7	D GND
PFI 13/P2.5	40	6	PFI 5/P1.5
PFI 15/P2.7	39	5	PFI 6/P1.6
PFI 7/P1.7	38	4	D GND
PFI 8/P2.0	37	3	PFI 9/P2.1
D GND	36	2	PFI 12/P2.4
D GND	35	1	PFI 14/P2.6

NC = No Connect

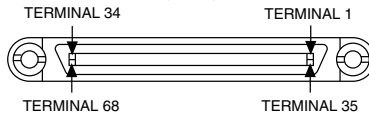


**Figure 7. NI USB-6366 Mass Termination Pinout**

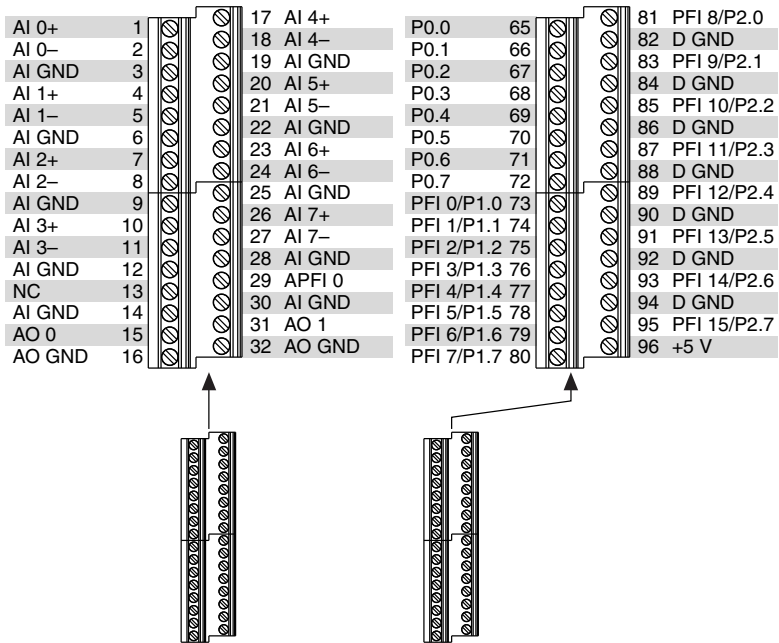
AI 0+	68	34	AI 0-
AI 0 GND	67	33	AI 1+
AI 1-	66	32	AI 1 GND
AI 2+	65	31	AI 2-
AI 2 GND	64	30	AI 3+
AI 3-	63	29	AI 3 GND
NC	62	28	AI 4+
AI 4-	61	27	AI 4 GND
AI 5+	60	26	AI 5-
AI 5 GND	59	25	AI 6+
AI 6-	58	24	AI 6 GND
AI 7+	57	23	AI 7-
AI 7 GND	56	22	AO 0
AO GND	55	21	AO 1
AO GND	54	20	APFI 0
D GND	53	19	P0.4
P0.0	52	18	D GND
P0.5	51	17	P0.1
D GND	50	16	P0.6
P0.2	49	15	D GND
P0.7	48	14	+5 V
P0.3	47	13	D GND
PFI 11/P2.3	46	12	D GND
PFI 10/P2.2	45	11	PFI 0/P1.0
D GND	44	10	PFI 1/P1.1
PFI 2/P1.2	43	9	D GND
PFI 3/P1.3	42	8	+5 V
PFI 4/P1.4	41	7	D GND
PFI 13/P2.5	40	6	PFI 5/P1.5
PFI 15/P2.7	39	5	PFI 6/P1.6
PFI 7/P1.7	38	4	D GND
PFI 8/P2.0	37	3	PFI 9/P2.1
D GND	36	2	PFI 12/P2.4
D GND	35	1	PFI 14/P2.6

NC = No Connect

CONNECTOR 0  
(AI 0-7)

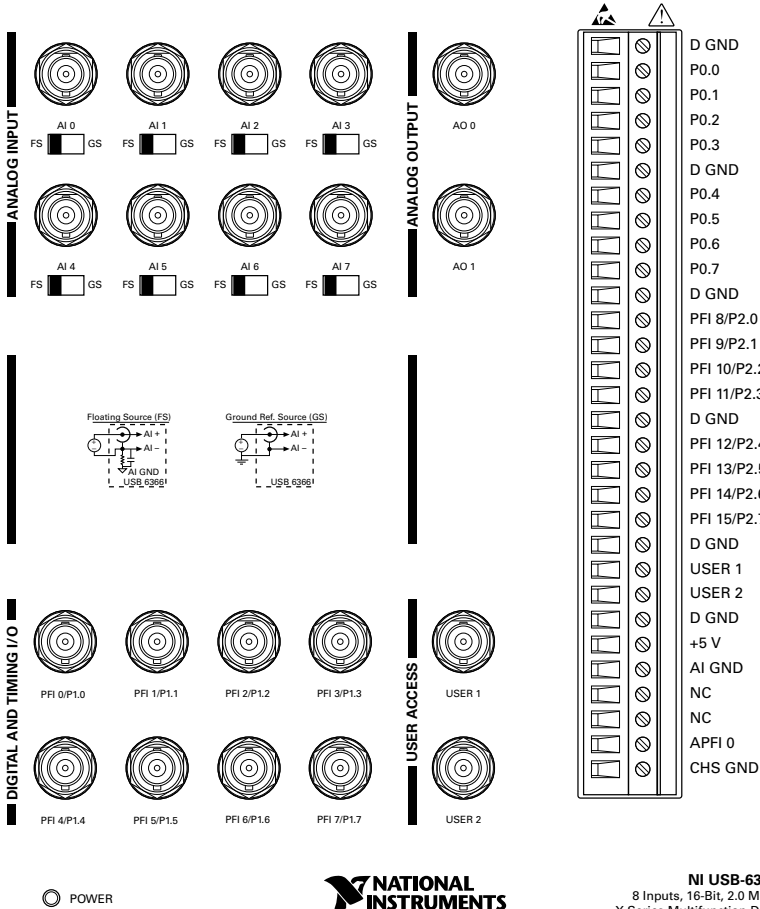


**Figure 8. NI USB-6366 Screw Terminal Pinout**



NC = No Connect

**Figure 9. NI USB-6366 BNC Front Panel and Pinout**



Refer to the *NI Trademarks and Logo Guidelines* at [ni.com/trademarks](http://ni.com/trademarks) for information on NI trademarks. Other product and company names mentioned herein are trademarks or trade names of their respective companies. For patents covering NI products/technology, refer to the appropriate location: **Help»Patents** in your software, the `patents.txt` file on your media, or the *National Instruments Patent Notice* at [ni.com/patents](http://ni.com/patents). You can find information about end-user license agreements (EULAs) and third-party legal notices in the `readme` file for your NI product. Refer to the *Export Compliance Information* at [ni.com/legal/export-compliance](http://ni.com/legal/export-compliance) for the NI global trade compliance policy and how to obtain relevant HTS codes, ECCNs, and other import/export data. NI MAKES NO EXPRESS OR IMPLIED WARRANTIES AS TO THE ACCURACY OF THE INFORMATION CONTAINED HEREIN AND SHALL NOT BE LIABLE FOR ANY ERRORS. U.S. Government Customers: The data contained in this manual was developed at private expense and is subject to the applicable limited rights and restricted data rights as set forth in FAR 52.227-14, DFAR 252.227-7014, and DFAR 252.227-7015.