

## COMPREHENSIVE SERVICES

We offer competitive repair and calibration services, as well as easily accessible documentation and free downloadable resources.

## SELL YOUR SURPLUS

We buy new, used, decommissioned, and surplus parts from every NI series. We work out the best solution to suit your individual needs.

 Sell For Cash    Get Credit    Receive a Trade-In Deal

## OBSOLETE NI HARDWARE IN STOCK & READY TO SHIP

We stock **New**, **New Surplus**, **Refurbished**, and **Reconditioned** NI Hardware.



*Bridging the gap between the manufacturer and your legacy test system.*

 1-800-915-6216

 [www.apexwaves.com](http://www.apexwaves.com)

 [sales@apexwaves.com](mailto:sales@apexwaves.com)

*All trademarks, brands, and brand names are the property of their respective owners.*

**Request a Quote**

 **CLICK HERE**

**PXIe-6555**

# NI PXIe-6555/6556 Specifications

200 MHz Digital Waveform Generator/Analyzer with PPMU

このドキュメントには、日本語ページも含まれています。

This document provides the specifications for the NI PXIe-6555 (NI 6555) and the NI PXIe-6556 (NI 6556). Specifications are subject to change without notice. For the most recent NI 6555/6556 specifications, visit [ni.com/manuals](http://ni.com/manuals). To access the NI 6555/6556 documentation, including the *NI Digital Waveform Generator/Analyzer Getting Started Guide*, which contains functional descriptions of the NI 6555/6556 signals and the connector pinouts, navigate to **Start»Programs»National Instruments»NI-HSDIO»Documentation**.



**Caution** The NI 6555/6556 has a maximum operating temperature range of 0 °C to +45 °C in all NI PXI Express and hybrid NI PXI Express chassis.



**Hot Surface** If the NI 6555/6556 has been in use, it might exceed safe handling temperatures and cause burns. Allow time to cool before removing the NI 6555/6556 from the chassis.



**Caution** Refer to the *Read Me First: Safety and Electromagnetic Compatibility* document for important safety and electromagnetic compatibility information. To obtain a copy of this document online, visit [ni.com/manuals](http://ni.com/manuals), and search for the document title.



**Caution** To ensure the specified EMC performance, operate this product only with shielded cables and accessories.



**Caution** To ensure specified EMC performance, you must install PXI EMC Filler Panels, National Instruments part number 778700-01, in all open chassis slots.



**Caution** To ensure the specified EMC performance, all I/O cables must be no longer than 3 m (10 ft).



**Note** All values were obtained using a 1 m cable (SHC68-C68-D4 recommended). Performance specifications are not guaranteed when using longer cables.

# Terminology

---

*Maximum* and *minimum* specifications are warranted not to exceed these values within certain operating conditions and include the effects of temperature and uncertainty unless otherwise noted.

*Typical* specifications are unwarranted values that are representative of a majority ( $3\sigma$ ) of units within certain operating conditions and include the effects of temperature and uncertainty unless otherwise noted.

*Characteristic* specifications are unwarranted values that are representative of an average unit operating at room temperature.

*Nominal* specifications are unwarranted values that are relevant to the use of the product and convey the expected performance of the product.

All specifications are *Typical* unless otherwise noted. These specifications are valid within the operating temperature range. Accuracy specifications are valid within  $\pm 5\text{ }^{\circ}\text{C}$  of self-calibration unless otherwise noted.

## Contents

---

Terminology.....	2
Channel Specifications .....	3
Digital Generation Channels (DIO <0..23>, PFI 1, PFI 2, PFI 4, and PFI 5).....	4
Digital Acquisition Channels (DIO <0..23>, PFI 1, PFI 2, PFI 4, and PFI 5).....	5
Active Load Channels (Data <0..23> and PFI <1,2,4,5> Channels).....	6
PPMU Channels (DIO <0..23>, PFI 1, PFI 2, PFI 4, and PFI 5).....	7
General PFI Channels (PFI 0, PFI 3, and PFI <24..31>).....	14
EXTERNAL FORCE and EXTERNAL SENSE Channels .....	14
CAL Channels.....	15
Timing Specifications .....	15
Sample Clock.....	15
Generation Timing (Data, DDC CLK OUT, and PFI <0..3> Channels) .....	18
Generation Provided Setup and Hold Times .....	20
Acquisition Timing (Data, STROBE, and PFI <0..3> Channels).....	22
Setup and Hold Times to STROBE .....	24
CLK IN (SMA Jack Connector) .....	27
PFI 5 as STROBE (DDC Connector) .....	28
PXIe_DStarA (PXI Express Backplane) .....	28
CLK OUT (SMA Jack Connector) .....	29
PFI 4 as DDC CLK OUT (DDC Connector).....	29
Reference Clock (PLL).....	30
Waveform Specifications.....	31
Memory and Scripting .....	31
Triggers (Inputs to the NI 6556).....	34
Events (Generated from the NI 6556).....	35
Miscellaneous .....	36

Power .....	36
Physical .....	37
I/O Panel Connectors .....	37
Software .....	38
Environment .....	38
Safety .....	39
Electromagnetic Compatibility .....	39
CE Compliance .....	40
Online Product Certification .....	40
Environmental Management .....	40
Where to Go for Support .....	41

## Channel Specifications

Specification	Value	Comments
Number of data channels	24, per pin parametric measurement unit (PPMU) enabled	All data channels have pattern memory.
Direction control of data channels	Per channel	—
Number of programmable function interface (PFI) channels	4 PPMU-enabled PFI channels: PFI 1, PFI 2, PFI 4/DDC CLK OUT, and PFI 5/STROBE  10 general PFI channels: PFI 0, PFI 3, and PFI <24..31>	Refer to the <a href="#">Waveform Specifications</a> section for more details.
Direction control of PFI channels	Per channel	—
Number of clock terminals	4 input 2 output	Refer to the <a href="#">Timing Specifications</a> section for more details.
Number of remote sense channels	28	All PPMU-enabled channels have remote sense capability.

# Digital Generation Channels (DIO <0..23>, PFI 1, PFI 2, PFI 4, and PFI 5)



**Note** These features are controlled independently per channel.

Specification	Value		Comments
Generation signal type	Single-ended, ground referenced.		—
Programmable generation voltage levels	Drive Voltage High Level ( $V_{OH}$ ) Drive Voltage Low Level ( $V_{OL}$ ) Drive Tristate ( $V_{TT}$ )		—
Generation voltage range	-2 V to 6 V (default) or -1 V to 7 V		Software-selectable.
Generation voltage resolution	122 $\mu$ V		—
DC generation voltage accuracy	<b><math>\pm 5</math> °C of Self-Calibration</b>	<b><math>\pm 15</math> °C of Self-Calibration</b>	Maximum accuracy when operating within the specified self-calibration temperature range.
	$\pm 11$ mV	$\pm 16$ mV	
Generation voltage swing	400 mV to 8.0 V		Into a 1 M $\Omega$ load. Power limitations may restrict the number of channels toggling at full voltage swing.
Output impedance	50 $\Omega$		Nominal.

Specification	Value	Comments
Maximum allowed DC drive strength per channel	$\pm 35$ mA	Nominal. Do <i>not</i> exceed the maximum power limit of the device.
Data channel tristate control	Per channel, per cycle	Software-selectable and hardware-timed.
Channel power-on state	Drivers disabled, high impedance	—
Output protection	The device can indefinitely sustain a short to any voltage between -3 V and 8.5 V provided that you observe the maximum drive strength limitations.	—

## Digital Acquisition Channels (DIO <0..23>, PFI 1, PFI 2, PFI 4, and PFI 5)



**Note** These features are controlled independently per channel.

Specification	Value	Comments
Acquisition signal type	Single-ended, ground referenced	—
Programmable acquisition voltages	Compare Voltage High Threshold ( $V_{IH}$ ) Compare Voltage Low Threshold ( $V_{IL}$ ) Termination Voltage ( $V_{TT}$ )	—
Acquisition voltage threshold range	-2 V to 7 V	—
Acquisition and termination voltage resolution	122 $\mu$ V	—
Termination voltage range	-2 V to 6 V (default) or -1 V to 7 V	—

Specification	Value		Comments
DC acquisition voltage accuracy	<b>±5 °C of Self-Calibration</b>	<b>±15 °C of Self-Calibration</b>	Maximum accuracy when operating within the specified self-calibration temperature range between -1.5 V and 6.8 V.
	(V <sub>IL</sub> ) = ±25 mV (V <sub>IH</sub> ) = ±25 mV (V <sub>TT</sub> ) = ±11 mV	(V <sub>IL</sub> ) = ±28 mV (V <sub>IH</sub> ) = ±28 mV (V <sub>TT</sub> ) = ±16 mV	
Minimum detectable voltage swing	50 mV		—
Input impedance	High-impedance or 50 Ω terminated into V <sub>TT</sub> .		Software-selectable.
High impedance leakage	<5 nA		Characteristic.
Input protection	The device can indefinitely sustain a short to any voltage between -3 V and 8.5 V, provided that you observe the maximum drive strength limitations.		—

## Active Load Channels (Data <0..23> and PFI <1,2,4,5> Channels)



**Note** Active Loads are supported only for the NI 6556.



**Note** These features are controlled independently per channel.

Specification	Value			Comments
Programmable levels	Commutating Voltage (V <sub>TT</sub> ) Current Source (I <sub>SOURCE</sub> ) Current Sink (I <sub>SINK</sub> )			—
Load	<b>Range</b>	<b>Resolution</b>	<b>Accuracy (±15 °C of Self-Calibration)</b>	Typical accuracy with 3 V overdrive.
	1.5 mA to 24 mA	488 nA	±1 mA	

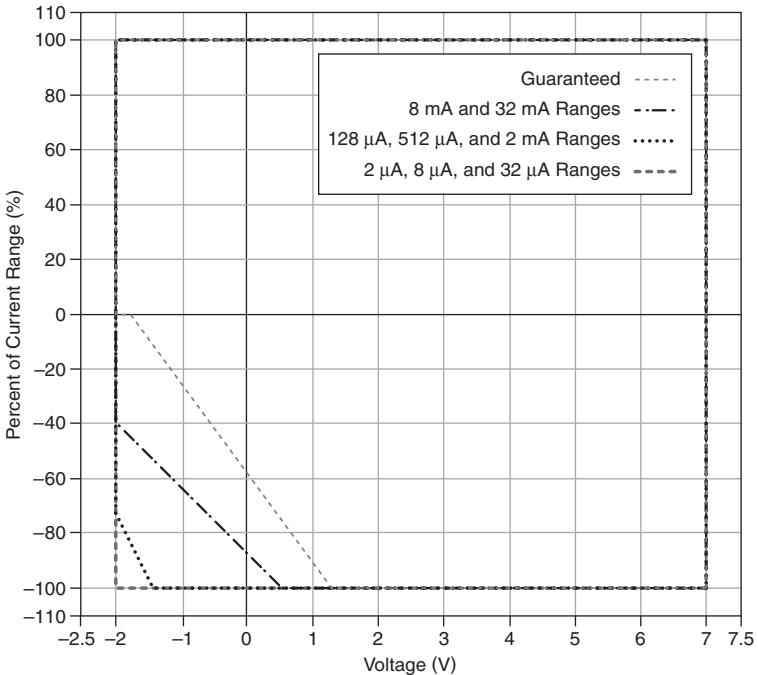
# PPMU Channels (DIO <0..23>, PFI 1, PFI 2, PFI 4, and PFI 5)



**Note** These features are controlled independently per channel.

Specification	Value	Comments
PPMU signal type	Single-ended, ground referenced	Referenced to the ground pins on the VHDCI connector.
Programmable levels	Force voltage ( $F_V$ ) Force current ( $F_I$ ) Voltage clamp high ( $V_{CHI}$ ) Voltage clamp low ( $V_{CLO}$ )	Voltage clamps are only active when forcing current.

**Figure 1. Characteristic Quadrant Behavior by Current Range**

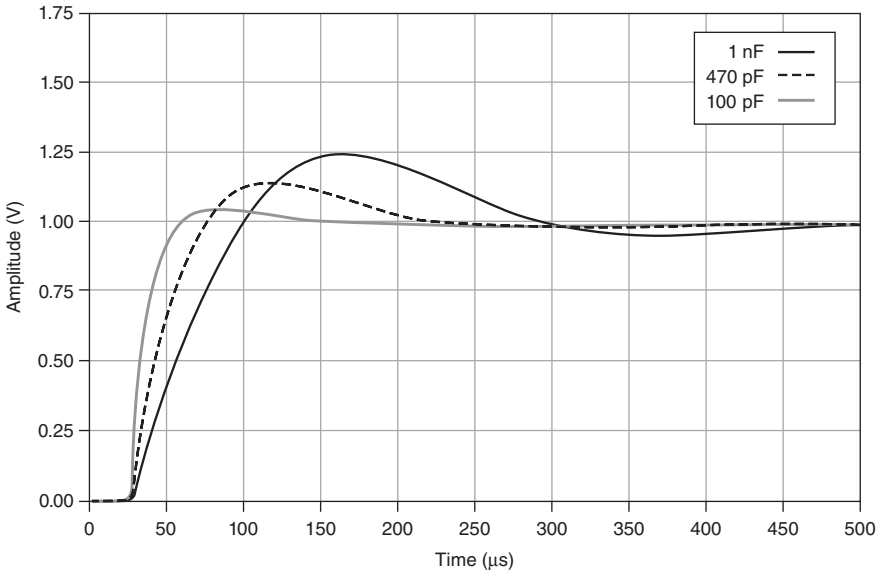




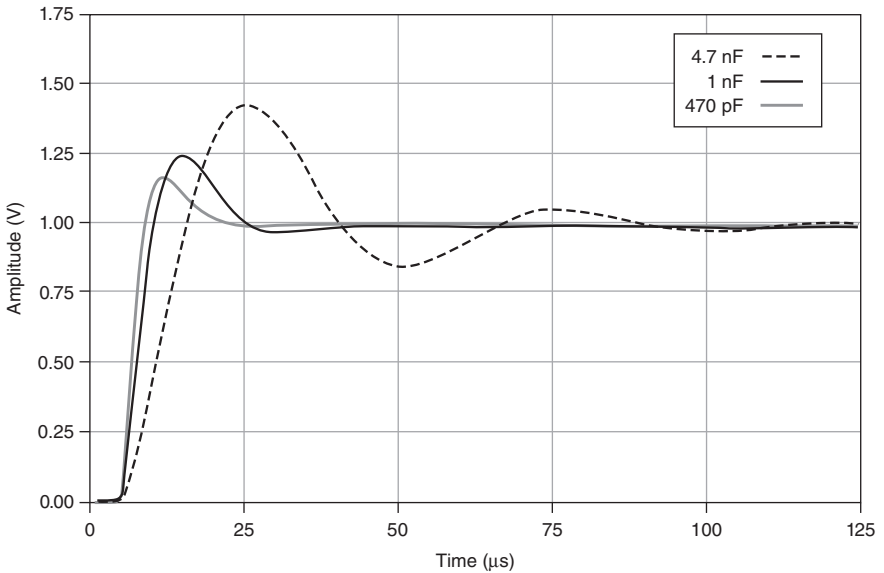
Specification	Value				Comments
Force voltage	<b>Ranges</b>	<b>Resolution</b>	<b>Accuracy within <math>\pm 5^\circ\text{C}</math> of Self-Calibration</b>	<b>Accuracy within <math>\pm 15^\circ\text{C}</math> of Self-Calibration</b>	Maximum accuracy at the sense location.
	-2 V to 6 V (default) -1 V to 7 V	122 $\mu\text{V}$	$\pm 11\text{ mV}$	$\pm 16\text{ mV}$	
Force voltage settling time	<b>Current Range</b>		<b>Settling Time</b>		Settled to 1% of the final value. 1 V steps with 50% of the current range load into 100 pF.
	2 $\mu\text{A}$		150 $\mu\text{s}$		
	8 $\mu\text{A}$		75 $\mu\text{s}$		
	32 $\mu\text{A}$ , 128 $\mu\text{A}$ , 512 $\mu\text{A}$		40 $\mu\text{s}$		
	2 mA		45 $\mu\text{s}$		
	8 mA		55 $\mu\text{s}$		
	32 mA		60 $\mu\text{s}$		
Load capacitance	<b>Current Range</b>		<b>Capacitance</b>		These values represent the allowed load capacitance through a 1 m SHC68-C68-D4 cable to ensure a well-behaved transient response.
	2 $\mu\text{A}$		1 nF		
	8 $\mu\text{A}$		1 nF		
	32 $\mu\text{A}$		1 nF		
	128 $\mu\text{A}$		1 nF		
	512 $\mu\text{A}$		4.7 nF		
	2 mA		10 nF		
	8 mA		47 nF		
32 mA		100 nF			

# Characteristic Step Response

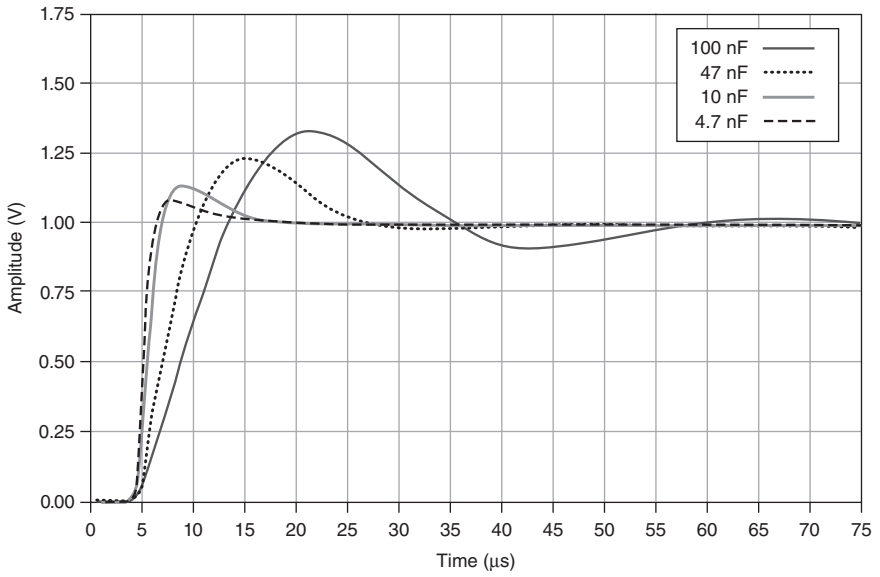
**Figure 2.** Characteristic Step Response into a Capacitive Load in the 2  $\mu\text{A}$  Range



**Figure 3.** Characteristic Step Response into a Capacitive Load in the 512  $\mu\text{A}$  Range

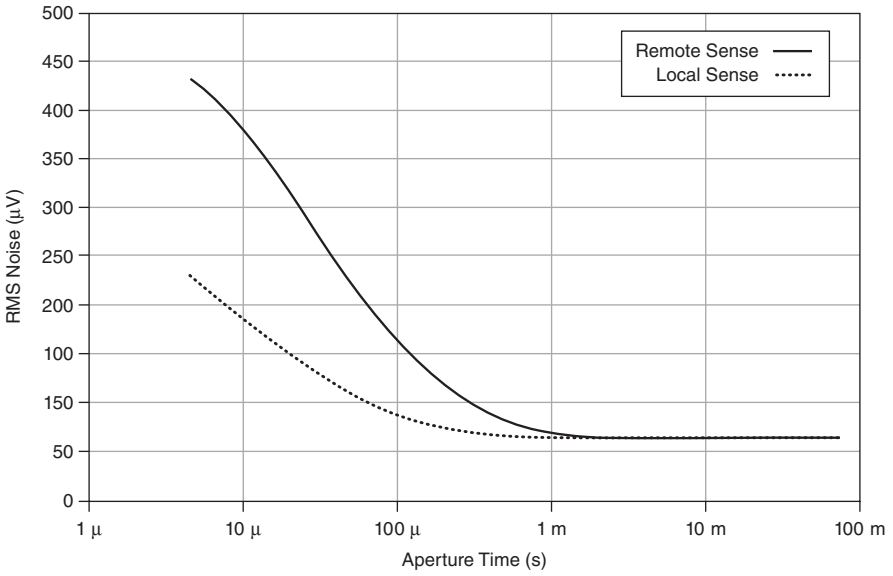


**Figure 4.** Characteristic Step Response into a Capacitive Load in the 32 mA Range



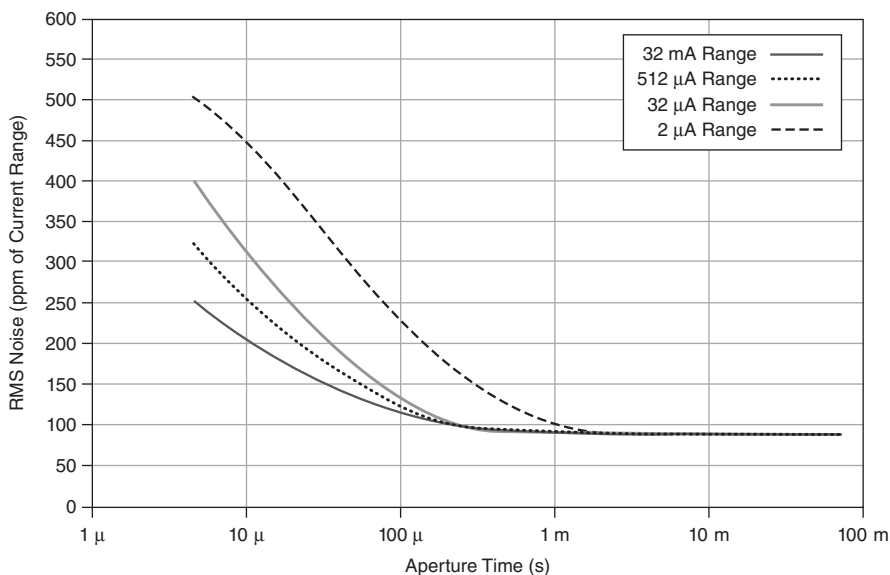
Specification	Value			Comments
Force current resolution	<b>Current Range</b>		<b>Resolution</b>	Nominal.
	±2 μA		60 pA	
	±8 μA		240 pA	
	±32 μA		980 pA	
	±128 μA		3.9 nA	
	±512 μA		15.6 nA	
	±2 mA		60 nA	
	±8 mA		240 nA	
	±32 mA		980 nA	
Force current accuracy	<b>Accuracy within ±5 °C of Self-Calibration</b>		<b>Accuracy within ±15 °C of Self-Calibration</b>	Maximum.
	1% of range		1.3% of range	
Force current voltage clamps	<b>Current Range</b>		<b>Resolution</b>	Maximum. Voltage clamps begin to conduct within 700 mV of the programmable voltage level.
	V <sub>CLO</sub>	-2 V to 6 V	122 μV	
	V <sub>CHI</sub>	-1 V to 7 V		
	<b>Note:</b> (V <sub>CHI</sub> - V <sub>CLO</sub> ) > 1 V			
Aperture time range	4 μs to 65 ms			—
Aperture time resolution	4 μs			—
Measure voltage	<b>Range</b>		<b>Resolution</b>	Maximum accuracy at the sense location with one 60 Hz PLC aperture.
	-2 V to 7 V		228 μV	
			<b>Accuracy within ±15 °C of Self-Calibration</b>	
			±3 mV	

**Figure 5.** Typical Voltage Measurement Noise for Given Aperture Times



Specification	Value		Comments
Measure current resolution	<b>Current Range</b>	<b>Resolution</b>	Nominal.
	±2 µA	460 pA	
	±8 µA	1.8 nA	
	±32 µA	7.3 nA	
	±128 µA	30 nA	
	±512 µA	120 nA	
	±2 mA	460 nA	
	±8 mA	1.8 µA	
	±32 mA	7.3 µA	
Measure current accuracy	<b>Accuracy within ±5 °C of Self-Calibration</b>	<b>Accuracy within ±15 °C of Self-Calibration</b>	Maximum accuracy with one 60 Hz PLC aperture.
	1% of range	1.3% of range	

**Figure 6.** Typical Current Measurement Noise for Given Aperture Times



**Note**  $I_{RMS} Noise$  is represented by the following equation:

$$I_{RMS} Noise = (RMS Noise \times Current Range) / 10^6$$

For example, 100 ppm on a 32 mA range yields a noise of 3.2 μA RMS.

$$3.2 \mu A RMS = (100 ppm \times 32 mA) / 10^6$$

Specification	Value	Comments
I/O switch resistance	5.5 Ω	Nominal.
Remote feedback impedance	100 kΩ	Nominal.
Output protection	The device can indefinitely sustain a short to any voltage between -3 V and 8.5 V, provided that you observe the maximum drive strength limitations.	—

## General PFI Channels (PFI 0, PFI 3, and PFI <24..31>)

Specification	Value		Comments
Circuit type	PFI 0 and PFI 3: High-speed I/O circuits PFI <24..31>: 5 V compatible I/O circuits		—
Generation voltage level	<b>Low Voltage Levels, Characteristic</b>	<b>High Voltage Levels, Characteristic</b>	Nominal.
	0 V	3.3 V	
Drive strength	PFI 0 and PFI 3: $\pm 33$ mA PFI <24..31>: $\pm 85$ mA		—
Output impedance	50 $\Omega$		Nominal.
Output protection	The device can indefinitely sustain a short to any voltage between 0 V and 5 V.		—
Acquisition voltage level	<b>Low Voltage Thresholds</b>	<b>High Voltage Thresholds</b>	Nominal.
	0.8 V	2 V	
Input protection	PFI 0 and PFI 3: -1 V to 5 V PFI <24..31>: -1 V to 6.5 V		Maximum.

## EXTERNAL FORCE and EXTERNAL SENSE Channels



**Note** These specifications are valid for the EXTERNAL FORCE and EXTERNAL SENSE channels on the AUX I/O connector or on the REMOTE SENSE connector. The AUX I/O connector is available only on NI 6556 devices.

Specification	Value	Comments
Direction	EXTERNAL FORCE: input to the device EXTERNAL SENSE: output from the device	—
Analog bandwidth	EXTERNAL FORCE: 3 MHz EXTERNAL SENSE: 30 kHz	Characteristic with a single channel connected.
Range	-2 V to 7 V	—

Specification	Value	Comments
Maximum current	±32 mA	Valid for EXTERNAL FORCE only.
Input protection	The device can indefinitely sustain a short to any voltage between -3 V and 8.5 V, provided that you observe the maximum drive strength limitations.	—

## CAL Channels



**Note** These specifications are valid for the CAL channel on the AUX I/O connector and on the REMOTE SENSE connector. The AUX I/O connector is available only on NI 6556 devices.

Specification	Value	Comments
Direction	Output from the NI 6556 during external calibration. This channel is in a high-impedance or undriven state during normal operation.	—
Voltage level	5 V	Nominal.
Drive strength	1 mA	Maximum allowed. Sourcing only.

## Timing Specifications

### Sample Clock

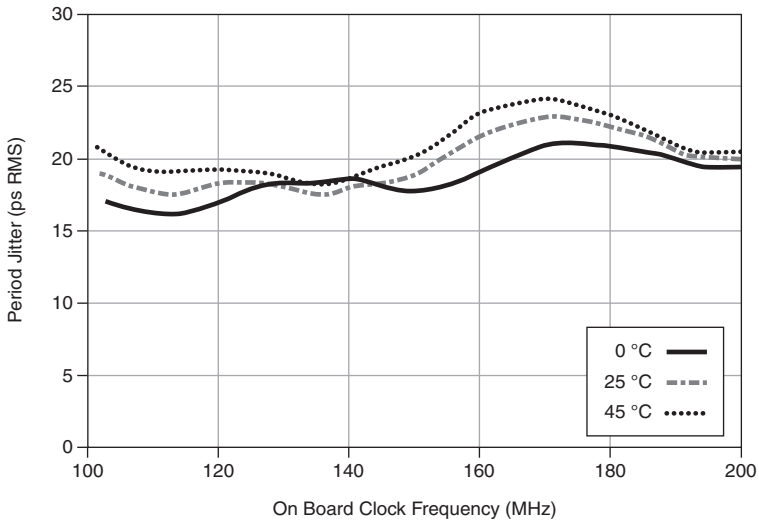
Specification	Value	Comments
Sample clock sources	<ol style="list-style-type: none"> <li>1. Onboard Clock</li> <li>2. CLK IN (SMA jack connector)</li> <li>3. PXIe_DStarA (PXI Express backplane)</li> <li>4. STROBE (Digital Data &amp; Control (DDC) connector; acquisition only)</li> </ol>	—
On Board Clock frequency range	800 Hz to 200 MHz	—



Specification	Value	Comments
On Board Clock frequency resolution	<0.1 Hz	NI-HSDIO may be queried for the programmed frequency value.
On Board Clock frequency accuracy	±150 ppm	Nominal. Accuracy may be increased by using a higher performance external Reference clock.
CLK IN frequency range	20 kHz to 200 MHz	Refer to the <i>CLK IN (SMA Jack Connector)</i> section for restrictions based on waveform type.
PXIe_DStarA frequency range	800 Hz to 200 MHz	Refer to the <i>PXIe_DStarA (PXI Express Backplane)</i> section for more information.
STROBE frequency range	800 Hz to 200 MHz	Refer to the <i>PFI 5 as STROBE (DDC Connector)</i> section for more information.
Sample clock relative delay adjustment range	±5 ns	To align multiple devices, apply a delay or phase adjustment to the On Board Clock.
Sample clock relative delay adjustment resolution	3.125 ps	
Exported Sample clock destinations	<ol style="list-style-type: none"> <li>DDC CLK OUT (DDC connector)</li> <li>CLK OUT (SMA jack connector)</li> </ol>	Internal Sample clocks with sources other than STROBE can be exported.

Specification	Value		Comments
Exported Sample clock offset range ( $t_{CO}$ )	0 ns to 2.4 ns		Software programmable.
Exported Sample clock offset resolution ( $t_{CO}$ )	13 ps		
Exported Sample clock offset accuracy ( $t_{CO}$ )	$\pm 200$ ps		Software programmable.
Exported Sample clock duty cycle (DDC CLK OUT)	<b>Minimum</b>	<b>Maximum</b>	3.3 V at maximum clock rate (200 MHz). Not including the effects of system crosstalk.
	42%	55%	
Exported Sample clock period jitter	24 $\text{ps}_{\text{rms}}$		Characteristic; using On Board Clock.

**Figure 7.** Characteristic Period Jitter (RMS) versus Frequency



# Generation Timing (Data, DDC CLK OUT, and PFI <0..3> Channels)

Specification	Value	Comments
Maximum data rate per channel	200 Mbps Supported for all logic families	—
Maximum data channel toggle rate	3.3 V swing: 100 MHz 5 V swing: 50 MHz	Toggle rates exceeding these values may invalidate CE certifications. Refer to the <a href="#">Electromagnetic Compatibility</a> section for more information.

Figure 8 shows an eye diagram of a 200 Mbps pseudorandom bit sequence (PRBS) waveform at 3.3 V. This waveform was captured on a characteristic DIO channel at room temperature into high-impedance.

**Figure 8.** Characteristic Eye Diagram at 3.3 V

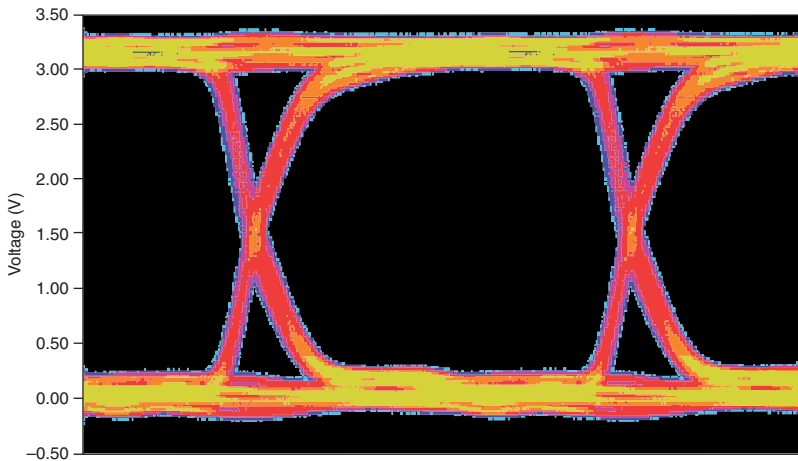
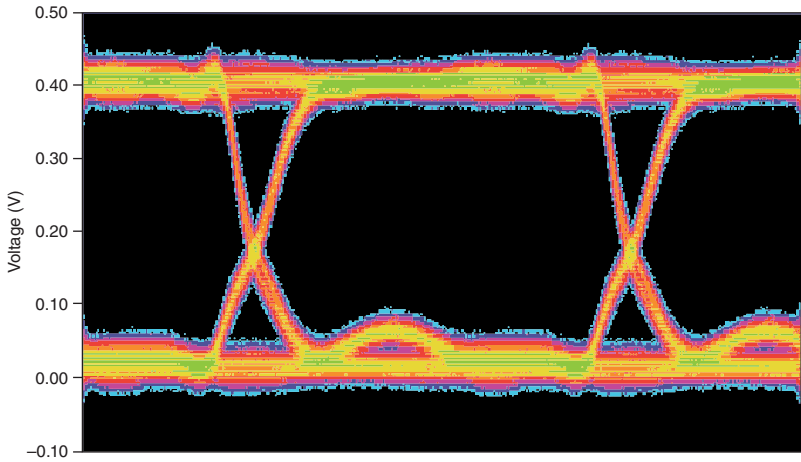


Figure 9 shows an eye diagram of a 200 Mbps PRBS waveform at 0.4 V. This waveform was captured on a characteristic DIO channel at room temperature into high-impedance.

**Figure 9. Characteristic Eye Diagram at 0.4 V**



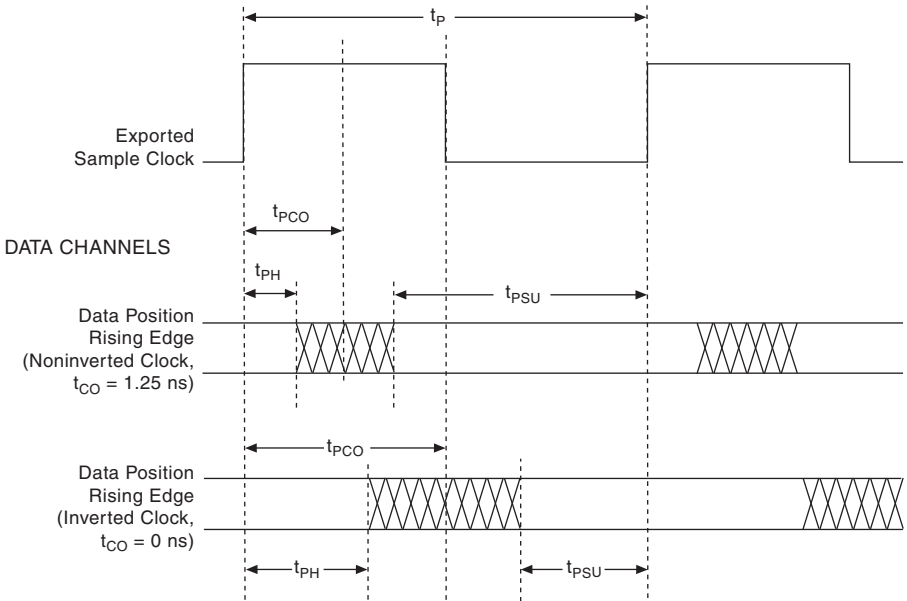
Specification	Value		Comments
Data channel-to-channel skew	<b>NI 6555</b>	<b>NI 6556</b>	There will be additional skew from crosstalk, acquisition threshold, and other transmission line effects in your system. You may see up to 150 ps of additional skew from differences between channels in the average rate of pattern transitions.
	Maximum: 750 ps Characteristic: 300 ps	Maximum: 600 ps Characteristic: 300 ps	
Data position modes	Sample clock rising edge Sample clock falling edge Delay from Sample clock rising edge		—
Generation data delay frequency	<b>On Board Clock</b>	<b>External Clock</b>	—
	All supported frequencies	Frequencies $\geq$ 20 MHz	

Specification	Value	Comments
Generation data delay range	-1 to 2 Sample clock cycles, expressed as a fraction of the Sample clock period	The sum of data delay and data deskew may not exceed -2 to 3 Sample clock cycles.
Generation data deskew range	-2 to 3 Sample clock cycles, expressed as a time in seconds	
Generation data delay and data deskew resolution	30 ps	Nominal.

## Generation Provided Setup and Hold Times

Specification	Value	
	NI 6555/6556	
Provided Setup Time ( $t_{PSU}$ )	$t_p - t_{CO} - 850$ ps	Characteristic
Provided Hold Time ( $t_{PH}$ )	$t_{CO} - 700$ ps	
Exported Sample Clock Offset ( $t_{CO}$ ) is software programmable.		
<p>Compare the setup and hold times from the datasheet of your device under test (DUT) to the values in the table above. The provided setup and hold times must be greater than the setup and hold times required for the DUT. If you require more setup time, configure your exported Sample clock mode to Inverted and/or delay your clock or data relative to the Sample clock.</p> <p>Refer to Figure 10 for a diagram illustrating the relationship between the exported Sample clock mode and the provided setup and hold times.</p> <p><b>Notes:</b> This table assumes the data position is set to Sample clock rising edge and the noninverted Sample clock is exported to the DDC connector with <math>t_{CO}</math> programmed using exported Sample clock offset.</p>		

**Figure 10.** Generation Provided Setup and Hold Times Timing Diagram



$$t_p = \frac{1}{f} = \text{Period of Sample Clock}$$

$t_{PH}$  = Provided Hold Time

$t_{PSU}$  = Provided Setup Time

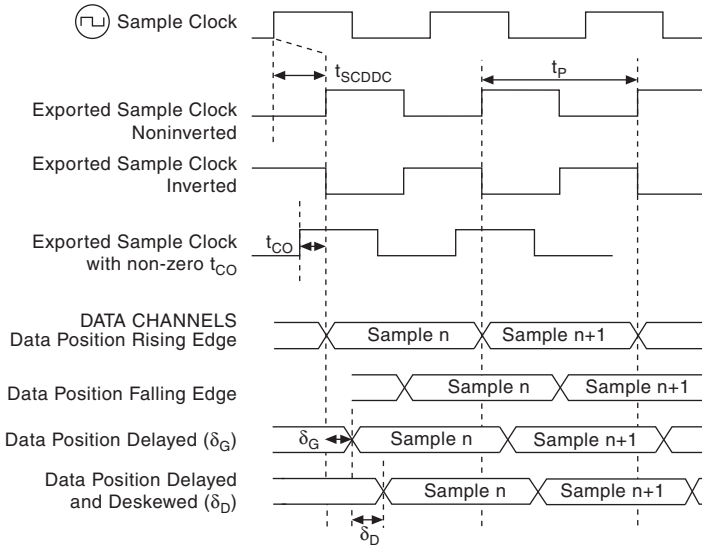
$t_{PCO}$  = Time from Rising Clock Edge to Data Transition (Provided Clock to Out Time)

$t_{CO}$  = Exported Sample Clock Offset



**Note** Provided setup and hold times account for maximum channel-to-channel skew and jitter.

**Figure 11. Generation Timing Diagram**



$t_{SCDDC}$  : Time Delay from Sample Clock (Internal) to DDC Connector

$-1 \leq \delta_G \leq 2$  : Pattern Generation Channel Data Delay (Fraction of  $t_p$ )

$t_p = \frac{1}{f}$  = Period of Sample Clock

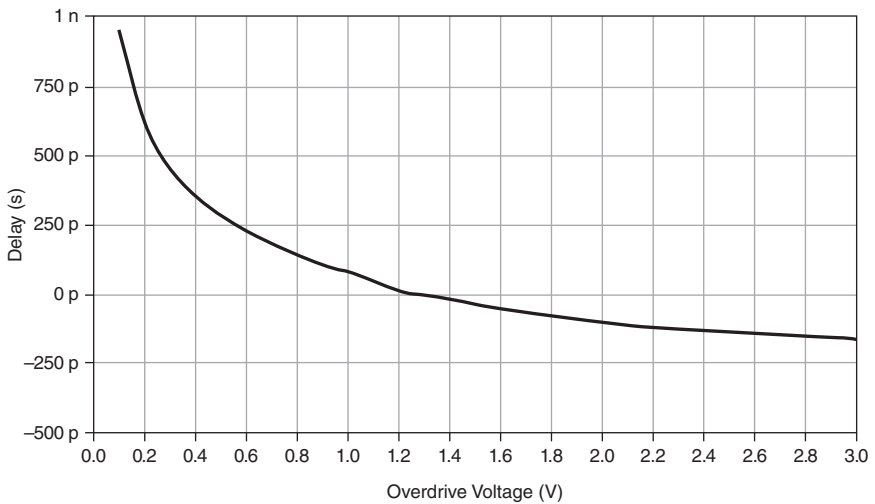
$t_{CO}$  = Exported Sample Clock Offset

$\delta_D$  = Pattern Generation Channel Deskew (Time)

# Acquisition Timing (Data, STROBE, and PFI <0..3> Channels)

Specification	Value		Comments
Maximum data rate per channel	200 Mbps		—
Channel-to-channel skew	<b>NI 6555</b>	<b>NI 6556</b>	There will be additional skew from crosstalk, acquisition threshold, overdrive, dispersion, and transmission line effects. You may see up to 175 ps of additional skew from differences between channels in the average rate of pattern transitions.
	Maximum: 725 ps Characteristic: 300 ps	Maximum: 600 ps Characteristic: 300 ps	

**Figure 12.** Typical Overdrive Dispersion Adjustment



**Note** Timing calibration executes with 1.25 V of overdrive.

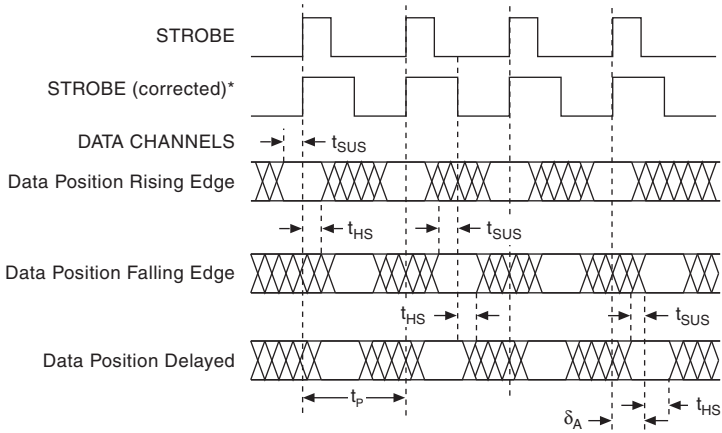


Specification	Value		Comments
Data position modes	Sample clock rising edge Sample clock falling edge Delay from Sample clock rising edge		—
Acquisition data delay and deskew frequency	<b>Onboard Clock</b>	<b>External Clock</b>	—
	All supported frequencies	Frequencies $\geq$ 20 MHz	
Acquisition data delay range	-1 to 2 Sample clock cycles expressed as a fraction of the Sample clock period.		The sum of data delay and data deskew may not exceed -2 to 3 Sample clock cycles.
Acquisition data deskew range	-2 to 3 Sample clock cycles expressed as a time in seconds.		
Acquisition data delay and data deskew resolution	30 ps		—

## Setup and Hold Times to STROBE

Specification	Value	
<b>Setup Time to STROBE (<math>t_{SUS}</math>)</b>		
	<b>NI 6555</b>	<b>NI 6556</b>
<b>f &lt; 20 MHz</b>	2.18 ns	2.2 ns
<b>f <math>\geq</math> 20 MHz</b>	1.82 ns	1.86 ns
<b>Hold Time to STROBE (<math>t_{HS}</math>)</b>		
	<b>NI 6555</b>	<b>NI 6556</b>
<b>f &lt; 20 MHz</b>	3.18 ns	3.47 ns
<b>f <math>\geq</math> 20 MHz</b>	1.41 ns	1.49 ns
<p>Includes maximum data channel-to-channel skew, but does not include system crosstalk. 1.65 V overdrive on all channels. Overall performance may vary with system crosstalk performance. NI 6556 values are specified within <math>\pm 15</math> °C of self-calibration.</p> <p>Refer to Figure 13 for a diagram illustrating the relationship between the exported Sample clock mode and the setup and hold times to STROBE.</p>		

**Figure 13. Acquisition Timing Diagram Using STROBE as the Sample Clock**



$t_{SUS}$  = Set-Up Time to STROBE

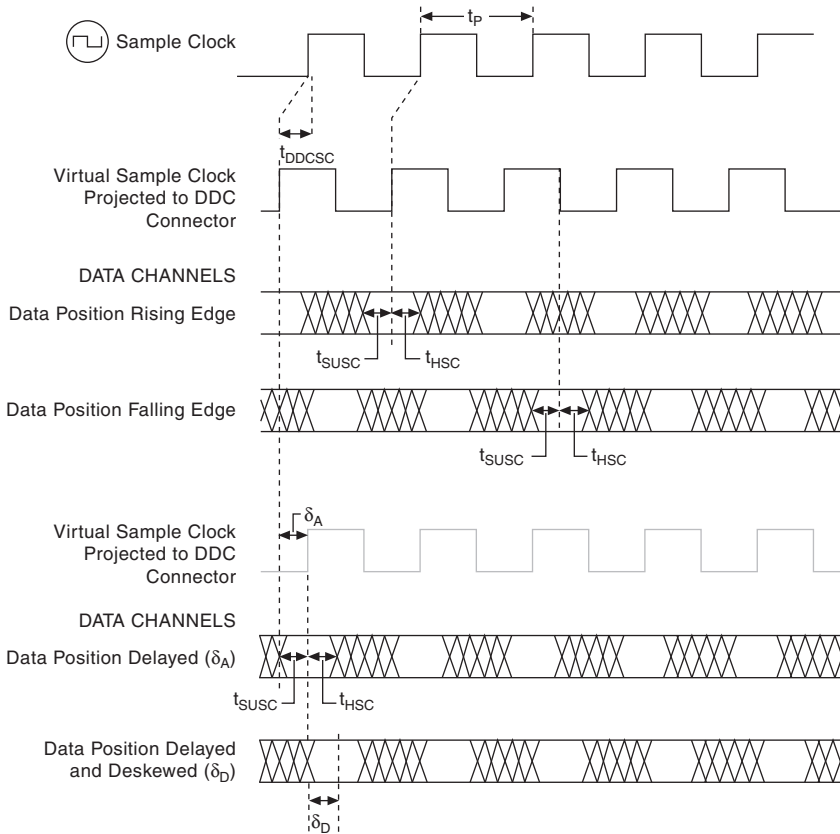
$t_{HS}$  = Hold Time from STROBE

$-1 \leq \delta_A \leq 2$  : Acquisition Data Delay (fraction of  $t_p$ )

$t_p = \frac{1}{f}$  = Sample Clock Period

\*Note: When using an external Sample clock greater than 20 MHz, the duty cycle is corrected to 50%.

**Figure 14. Acquisition Timing Diagram with Sample Clock Sources Other than STROBE**



$t_{DDCSC}$  : Time Delay from DDC Connector or to Internal Sample Clock

$-1 \leq \delta_A \leq 2$  : Pattern Acquisition Channel Data Delay (Fraction of  $t_p$ )

$t_p = \frac{1}{f}$  = Period of Sample Clock

$t_{SUSC}$  = Set-Up Time to Sample Clock

$t_{HSC}$  = Hold Time to Sample Clock

$\delta_D$  = Pattern Acquisition Channel Deskew (Time)

# CLK IN (SMA Jack Connector)

Specification	Value			Comments	
Direction	Input into device			—	
Destinations	1. Reference clock—for the phase lock loop (PLL) 2. Sample clock			—	
Input coupling	AC			—	
Input protection	±10 VDC			Nominal.	
Input impedance	50 Ω (default) or 1 kΩ			Software-selectable; Nominal.	
Minimum detectable pulse width	2 ns			—	
Clock requirements	Clock must be continuous and free-running.			—	
Clock ranges	<b>Square Waves</b>			Nominal. 3 dB cutoff point at 125 MHz when using 1 kΩ input impedance.	
	Voltage range	300 mV <sub>pp</sub> to 5.5 V <sub>pp</sub>			
	Frequency range	20 kHz to 200 MHz			
	Duty cycle range	40% to 60%			
	<b>Sine Waves</b>			—	
	Minimum voltage	630 mV <sub>pp</sub> (0 dBm)	1.265 V <sub>pp</sub> (6 dBm)		2.53 V <sub>pp</sub> (12 dBm)
	Maximum voltage	5.5 V <sub>pp</sub>			
	Minimum frequency	10 MHz	5 MHz		2.5 MHz
	Maximum frequency	200 MHz			

## PFI 5 as STROBE (DDC Connector)

Specification	Value	Comments
Direction	Input to device	—
Electrical characteristics	Refer to the <i>Digital Acquisition Channels (DIO &lt;0..23&gt;, PFI 1, PFI 2, PFI 4, and PFI 5)</i> specifications in the <i>Channel Specifications</i> section.	—
Destinations	Sample clock (acquisition only)	—
STROBE frequency range	800 Hz to 200 MHz	—
STROBE duty cycle range	40% to 60% for clock frequencies $\geq 20$ MHz 25% to 75% for clock frequencies $< 20$ MHz <b>Note:</b> STROBE duty cycle is corrected to 50% at frequencies $\geq 20$ MHz.	At the programmed voltage input high ( $V_{IH}$ ) threshold.
Minimum detectable pulse width	2 ns	
Clock requirements	Clock must be continuous and free-running.	—

## PXIe\_DStarA (PXI Express Backplane)

Specification	Value	Comments
Direction	Input to device	—
Destinations	1. Reference clock—for the phase lock loop (PLL) 2. Sample clock	—
PXIe_DStarA frequency range	800 Hz to 200 MHz	—
PXIe_DStarA duty cycle range	40% to 60%	—
Clock requirements	Clock must be continuous and free-running.	—

## CLK OUT (SMA Jack Connector)

Specification	Value		Comments
Direction	Output from device		—
Sources	1. Sample clock (excluding STROBE) 2. Reference clock (PLL)		—
Generation voltage level	<b>Low Voltage Levels, Characteristic</b>	<b>High Voltage Levels, Characteristic</b>	Nominal.
	0 V	3.3 V	
Drive strength	±33 mA		—
Output impedance	50 Ω		Nominal.
Output protection	The device can indefinitely sustain a short to any voltage between 0 V and 5 V.		—

## PFI 4 as DDC CLK OUT (DDC Connector)

Specification	Value	Comments
Direction	Output from device	—
Sources	Sample clock (generation only)	STROBE and acquisition Sample clock cannot be routed to DDC CLK OUT.
Electrical characteristics	Refer to the <i>Digital Generation Channels (DIO &lt;0..23&gt;, PFI 1, PFI 2, PFI 4, and PFI 5)</i> specifications in the <i>Channel Specifications</i> section.	—

# Reference Clock (PLL)

Specification	Value	Comments
Reference clock sources	<ol style="list-style-type: none"> <li>1. PXI_CLK100 (PXI Express backplane)</li> <li>2. CLK IN (SMA jack connector)</li> <li>3. PXIe_DStarA (PXI Express backplane)</li> <li>4. None (internal oscillator locked to an internal reference)</li> </ol>	Provides the reference frequency for the PLL.
Reference clock frequency range	5 MHz to 100 MHz (integer multiple of 1 MHz)	—
Reference clock frequency accuracy	< 5,000 ppm	Required accuracy of the external Reference clock source.
Lock time	≤ 25 ms	Not including software latency.
Reference clock duty cycle range	40% to 60%	—
Reference clock destinations	CLK OUT (SMA jack connector)	—

# Waveform Specifications

## Memory and Scripting

Specification	Value		Comments
Memory architecture	The NI 6555/6556 uses the Synchronization and Memory Core (SMC) technology in which waveforms and instructions share onboard memory. Parameters such as number of script instructions, maximum number of waveforms in memory, and number of samples available for waveform storage are flexible and user-defined.		Refer to the <i>Onboard Memory</i> section in the <i>NI Digital Waveform Generator/ Analyzer Help</i> for more information.
Onboard memory size (generation)	<b>NI 6555/NI 6556</b>	<b>NI 6556 Only</b>	Maximum limit for generation sessions assumes no scripting instructions.
	8 Mbit/channel	64 Mbit/channel	
Onboard memory size (acquisition)	8 Mbit/channel	64 Mbit/channel	—
Generation modes	<b>Single-waveform mode:</b> Generate a single waveform once, $n$ times, or continuously.		—
	<b>Scripted mode:</b> Generate a simple or complex sequence of waveforms. Use scripts to describe the waveforms to be generated, the order in which the waveforms are generated, how many times the waveforms are generated, and how the device responds to Script triggers.		



Specification	Value		Comments	
Generation minimum waveform size in samples (S)	<b>Configuration</b>	<b>Sample Rate</b>		Sample rate dependent. Increasing sample rate increases minimum waveform size requirement. For more information about these configurations, refer to the <i>Common Scripting Use Cases</i> topic in the <i>NI Digital Waveform Generator/ Analyzer Help</i> .
		<b>200 MHz</b>	<b>100 MHz</b>	
	Single waveform	1 S	1 S	
	Continuous waveform	128 S	64 S	
	Stepped sequence	128 S	64 S	
Burst sequence	1056 S	512 S		
Generation finite repeat count	1 to 16,777,216		—	
Generation waveform quantum	<b>Data Width = 4</b>	<b>Data Width = 2</b>	Regardless of waveform size, NI-HSDIO allocates waveforms in blocks of physical memory.	
	1 sample	2 samples		
Generation waveform block size (in physical memory)	<b>Data width = 4</b>	<b>Data width = 2</b>		
	32 samples	64 samples		
Acquisition minimum record size	1 sample		Regardless of waveform size, NI-HSDIO allocates at least 640 bytes for a record.	
Acquisition record quantum	1 sample		—	

Specification	Value	Comments
Acquisition maximum number of records	2,147,483,647	Session should fetch fast enough so that unfetched data is not overwritten.
Acquisition number of pre-Reference trigger samples	0 up to full record	—
Acquisition number of post-Reference trigger samples	0 up to full record	—
Hardware compare error FIFO depth	4,094	—
Hardware compare number of unique enable states	255	—
Hardware compare maximum speed	200 MHz	—

# Triggers (Inputs to the NI 6556)

Specification	Value	Comments
Trigger types	<ol style="list-style-type: none"> <li>1. Start trigger</li> <li>2. Pause trigger</li> <li>3. Script trigger &lt;0..3&gt; (generation sessions only)</li> <li>4. Reference trigger (acquisition sessions only)</li> <li>5. Advance trigger (acquisition sessions only)</li> <li>6. Stop Trigger (generation sessions only)</li> </ol>	—
Sources	<ol style="list-style-type: none"> <li>1. PFI 0 (SMA jack connector)</li> <li>2. PFI &lt;1..3&gt; (DDC connector)</li> <li>3. PFI &lt;24..31&gt; (DDC connector)</li> <li>4. PXI_TRIG&lt;0..7&gt; (PXI Express backplane)</li> <li>5. Pattern match (acquisition sessions only)</li> <li>6. Software (user function call)</li> <li>7. Disabled (do not wait for a trigger)</li> </ol>	—
Trigger detection	<ol style="list-style-type: none"> <li>1. Start trigger (edge detection: rising or falling)</li> <li>2. Pause trigger (level detection: high or low)</li> <li>3. Script trigger &lt;0..3&gt; (edge detection: rising or falling; level detection: high or low)</li> <li>4. Reference trigger (edge detection: rising or falling)</li> <li>5. Advance trigger (edge detection: rising or falling)</li> <li>6. Stop Trigger (edge detection: rising or falling)</li> </ol>	—
Minimum required trigger pulse width	15 ns	Typical. Only applies to Digital Edge Triggers.
Destinations	<ol style="list-style-type: none"> <li>1. PFI 0 (SMA jack connectors)</li> <li>2. PFI &lt;1..3&gt; (DDC connector)</li> <li>3. PFI &lt;24..31&gt; (DDC connector)</li> <li>4. PXI_TRIG&lt;0..6&gt; (PXI Express backplane)</li> </ol>	Each trigger can be routed to any destination except the Pause trigger. The Pause trigger cannot be exported.

Specification	Value				Comments
Trigger rearm time	<b>Start to Reference Trigger</b>	<b>Start to Advance Trigger</b>	<b>Advance to Advance Trigger</b>	<b>Reference to Reference Trigger</b>	Maximum number of samples.
	150 S	220 S	220 S	220 S	
Delay from Pause trigger to Pause state and Stop trigger to Done state	<b>Generation Sessions</b>		<b>Acquisition Sessions</b>		Maximum; Use the Data Active event during generation to determine on a sample by sample basis when the device enters the Pause or Done states.
	55 Sample Clock periods + 300 ns		Synchronous with the data.		
Delay from trigger to digital data output	6 Sample Clock periods + 600 ns				Maximum; Start trigger and Script triggers.

## Events (Generated from the NI 6556)

Specification	Value	Comments
Event type	<ol style="list-style-type: none"> <li>1. Marker &lt;0..2&gt; (generation sessions only)</li> <li>2. Data Active event (generation sessions only)</li> <li>3. Ready for Start event</li> <li>4. Ready for Advance event (acquisition sessions only)</li> <li>5. End of Record event (acquisition sessions only)</li> </ol>	—

Specification	Value	Comments
Destinations	<ol style="list-style-type: none"> <li>1. PFI 0 (SMA jack connectors)</li> <li>2. PFI &lt;1..3&gt; (DDC connector)</li> <li>3. PFI &lt;24..31&gt; (DDC connector)</li> <li>4. PXI_TRIG&lt;0..6&gt; (PXI Express backplane)</li> </ol>	Each event can be routed to any destination, except the Data Active event. The Data Active event can only be routed to the PFI channels.
Marker time resolution (placement)	Markers can be placed at any sample.	—

## Miscellaneous

Specification	Value	Comments
Warm-up time	30 minutes	From driver loaded.
External calibration interval	1 year	—

## Power

Specification	12 V	3.3 V	Total Power	Comments
Maximum allowed current	5.2 A	5.7 A	—	Maximum allowed power before device shut down requiring reset of the device.
Maximum allowed device power	—	—	76 W	

Specification	12 V	3.3 V	Total Power	Comments
3.3 V swing at 200 Mbps	4.5 A	4.1 A	67.5 W	Typical results are commensurate with an aggressive user application using all data channels into a high-impedance load with active loads disabled (unless otherwise noted) across temperature.
5.0 V swing at 100 Mbps	4.3 A	4.0 A	64.8 W	
8.0 V swing at 50 Mbps	4.3 A	3.8 A	64.1 W	
3.3 V swing at 100 Mbps with Active Load set to 24 mA	4.7 A	4.5 A	71.5 W	

## Physical

Specification	Value	Comments
Dimensions	21.6 × 2.0 × 13.0 cm Dual 3U CompactPCI Express slot; PXI Express compatible	—
Weight	28 oz (793 g)	—

## I/O Panel Connectors

Label	Function(s)	Connector Type
CLK IN	External Sample clock, external Reference clock.	SMA jack
PFI 0	Events, triggers.	SMA jack
CLK OUT	External Sample clock, exported Reference clock.	SMA jack
AUX I/O	External force, external sense, and analog calibration. <b>Note:</b> Supported on the NI 6556 only.	Combicon
Digital Data & Control (DDC)	Digital data channels, PPMU channels, exported Sample clock, STROBE, events, triggers.	68-pin VHDCI
REMOTE SENSE	PPMU remote sensing channels, external force, external sense, and analog calibration.	68-pin VHDCI

# Software

Specification	Value	Comments
Driver software	NI-HSDIO driver software 1.8.1 or later for the NI 6556; NI-HSDIO 1.9 for the NI 6555. NI-HSDIO allows you to configure and control the NI 6555/6556. NI-HSDIO provides application interfaces for many development environments. NI-HSDIO follows IVI application programming interface (API) guidelines.	—
Application software	NI-HSDIO provides programming interfaces for the following application development environments (ADEs): <ul style="list-style-type: none"> <li>National Instruments LabVIEW</li> <li>National Instruments LabWindows™/CVI™</li> <li>Microsoft Visual C/C++</li> </ul>	Refer to the <i>NI-HSDIO Readme</i> for more information about supported ADE versions.
Test panel	National Instruments Measurement & Automation Explorer (MAX) provides test panels with basic acquisition and generation functionality for the NI 6555/6556. MAX is included on the NI-HSDIO driver media.	—

# Environment



**Note** To ensure that the NI 6555/6556 cools effectively, follow the guidelines in the *Maintain Forced Air Cooling Note to Users* included with the NI 6555/6556. The NI 6555/6556 is intended for indoor use only.

Specification	Value	Comments
Operating temperature	0 to +45 °C in all NI PXI Express and hybrid NI PXI Express chassis. (Meets IEC 60068-2-2.)	—
Operating relative humidity	10% to 90% relative humidity, noncondensing (Meets IEC 60068-2-56.)	—
Altitude	2,000 m at 25 °C ambient temperature	—
Pollution Degree	2	—

Specification	Value	Comments
Storage temperature	-20 to +70 °C (Meets IEC-60068-2-2.)	—
Storage relative humidity	5% to 95% relative humidity, noncondensing (Meets IEC 60068-2-56.)	—
Operating shock	30 g, half-sine, 11 ms pulse (Meets IEC 60068-2-27. Test profile developed in accordance with MIL-PRF-28800F.)	—
Storage shock	50 g, half-sine, 11 ms pulse (Meets IEC 60068-2-27. Test profile developed in accordance with MIL-PRF-28800F.)	—
Operating vibration	5 Hz to 500 Hz, 0.3 g <sub>rms</sub> (Meets IEC 60068-2-64.)	—
Storage vibration	5 Hz to 500 Hz, 2.46 g <sub>rms</sub> (Meets IEC 60068-2-64. Test profile exceeds requirements of MIL-PRF-28800F, Class B.)	—

## Safety



**Caution** The protection provided by the NI PXIe-6555/6556 can be impaired if it is used in a manner not described in this document.

This product meets the requirements of the following standards of safety for electrical equipment for measurement, control, and laboratory use:

- IEC 61010-1, EN 61010-1
- UL 61010-1, CSA 61010-1



**Note** For UL and other safety certifications, refer to the product label or the [Online Product Certification](#) section.

## Electromagnetic Compatibility

This product meets the requirements of the following EMC standards for electrical equipment for measurement, control, and laboratory use:

- EN 61326-1 (IEC 61326-1): Class A emissions; Basic immunity
- EN 55011 (CISPR 11): Group 1, Class A emissions
- AS/NZS CISPR 11: Group 1, Class A emissions
- FCC 47 CFR Part 15B: Class A emissions
- ICES-001: Class A emissions





**Note** In the United States (per FCC 47 CFR), Class A equipment is intended for use in commercial, light-industrial, and heavy-industrial locations. In Europe, Canada, Australia, and New Zealand (per CISPR 11) Class A equipment is intended for use only in heavy-industrial locations.



**Note** Group 1 equipment (per CISPR 11) is any individual, scientific, or medical equipment that does not intentionally generate radio frequency energy for the treatment of material or inspection/analysis purposes.



**Note** For EMC declarations and certifications, refer to the *Online Product Certification* section of this document.

## CE Compliance

This product meets the essential requirements of applicable European Directives as follows:

- 2006/95/EC; Low-Voltage Directive (safety)
- 2004/108/EC; Electromagnetic Compatibility Directive (EMC)

## Online Product Certification

To obtain product certifications and the Declaration of Conformity for this product, visit [ni.com/certification](http://ni.com/certification), search by model number or product line, and click the appropriate link in the Certification column.

## Environmental Management

NI is committed to designing and manufacturing products in an environmentally responsible manner. NI recognizes that eliminating certain hazardous substances from our products is beneficial to the environment and to NI customers.

For additional environmental information, refer to the *Minimize Our Environmental Impact* web page at [ni.com/environment](http://ni.com/environment). This page contains the environmental regulations and directives with which NI complies, as well as other environmental information not included in this document.

## Waste Electrical and Electronic Equipment (WEEE)



**EU Customers** At the end of the product life cycle, all products *must* be sent to a WEEE recycling center. For more information about WEEE recycling centers, National Instruments WEEE initiatives, and compliance with WEEE Directive 2002/96/EC on Waste and Electronic Equipment, visit [ni.com/environment/weee](http://ni.com/environment/weee).

## 电子信息产品污染控制管理办法（中国 RoHS）



**中国客户** National Instruments 符合中国电子信息产品中限制使用某些有害物质指令 (RoHS)。关于 National Instruments 中国 RoHS 合规性信息，请登录 [ni.com/environment/rohs\\_china](http://ni.com/environment/rohs_china)。(For information about China RoHS compliance, go to [ni.com/environment/rohs\\_china](http://ni.com/environment/rohs_china).)

## Where to Go for Support

---

The National Instruments website is your complete resource for technical support. At [ni.com/support](http://ni.com/support) you have access to everything from troubleshooting and application development self-help resources to email and phone assistance from NI Application Engineers.

Visit [ni.com/services](http://ni.com/services) for NI Factory Installation Services, repairs, extended warranty, and other services.

Visit [ni.com/register](http://ni.com/register) to register your National Instruments product. Product registration facilitates technical support and ensures that you receive important information updates from NI.

A Declaration of Conformity (DoC) is our claim of compliance with the Council of the European Communities using the manufacturer's declaration of conformity. This system affords the user protection for electromagnetic compatibility (EMC) and product safety. You can obtain the DoC for your product by visiting [ni.com/certification](http://ni.com/certification). If your product supports calibration, you can obtain the calibration certificate for your product at [ni.com/calibration](http://ni.com/calibration).

National Instruments corporate headquarters is located at 11500 North Mopac Expressway, Austin, Texas, 78759-3504. National Instruments also has offices located around the world. For telephone support in the United States, create your service request at [ni.com/support](http://ni.com/support) or dial 512 795 8248. For telephone support outside the United States, visit the Worldwide Offices section of [ni.com/niglobal](http://ni.com/niglobal) to access the branch office websites, which provide up-to-date contact information, support phone numbers, email addresses, and current events.

Refer to the *NI Trademarks and Logo Guidelines* at [ni.com/trademarks](http://ni.com/trademarks) for more information on National Instruments trademarks. Other product and company names mentioned herein are trademarks or trade names of their respective companies. For patents covering National Instruments products/technology, refer to the appropriate location: **Help»Patents** in your software, the `patents.txt` file on your media, or the *National Instruments Patents Notice* at [ni.com/patents](http://ni.com/patents). You can find information about end-user license agreements (EULAs) and third-party legal notices in the `readme` file for your NI product. Refer to the *Export Compliance Information* at [ni.com/legal/export-compliance](http://ni.com/legal/export-compliance) for the National Instruments global trade compliance policy and how to obtain relevant HTS codes, ECCNs, and other import/export data.

© 2011–2013 National Instruments. All rights reserved.