

COMPREHENSIVE SERVICES

We offer competitive repair and calibration services, as well as easily accessible documentation and free downloadable resources.

SELL YOUR SURPLUS

We buy new, used, decommissioned, and surplus parts from every NI series. We work out the best solution to suit your individual needs.

 Sell For Cash  Get Credit  Receive a Trade-In Deal

OBSOLETE NI HARDWARE IN STOCK & READY TO SHIP

We stock **New**, **New Surplus**, **Refurbished**, and **Reconditioned** NI Hardware.



Bridging the gap between the manufacturer and your legacy test system.

 1-800-915-6216

 www.apexwaves.com

 sales@apexwaves.com

All trademarks, brands, and brand names are the property of their respective owners.

Request a Quote

 **CLICK HERE**

RMX-4122

SAFETY INFORMATION & INSTALLATION GUIDE

RMX Programmable Power Supplies

RMX-4120/4121/4122/4123/4124/4125/4126/4127

About the RMX Safety Information & Installation Guide

This guide is intended for users of the Regulated DC Power Supply and their instructors. It is assumed that the reader has knowledge about electrical safety standards and the electrical aspects of regulated DC power supplies.

Safety Guidelines



Indicates general danger, warning, or caution. When this symbol is marked on the product, see the relevant section in the operation manual.



Indicates a location whose surface can become hot.



Protective conductor terminal.



Chassis (frame) terminal.



On (supply).



Off (supply).

Installation and Preparation

This section describes how to turn on an RMX programmable power supply, what kind of load cables to use, and how to connect cables to the output connectors.



Note Protection provided by this equipment may be impaired if it is used in a manner not described in the manual.

Connecting the Power Cord

This product is a piece of equipment that conforms to IEC Overvoltage Category II (equipment that consumes energy supplied from a fixed installation).

A power cord is not included with the RMX-4124/4125/4126/4127. Use a power cord that conforms to this product's rated AC input voltage, input current, and configured for the plug type. Refer to your product specifications for details.



Caution Risk of electric shock. This product is a piece of equipment that conforms to IEC Safety Class I (equipment that has a protective conductor terminal). Be sure to earth ground the product to prevent electric shock. The product is grounded through the power cord ground wire. Connect the protective conductor terminal to earth ground.

RMX-4120/4121/4122/4123 (750 W Models)

Necessary Cable

- **North America**—Extra Hard Usage Cord, min. 300 V, 60 C, 14 AWG, 3 Conductor cord, 3 m or less with a NEMA 5-15P to C14.
- **Europe**—HAR Marked, min. 300 V, 60 C, 2.5mm², 3 Conductor cord, 3 m or less with a plug configured for the country of use to C14.
- **International**—Certified for country of use, min. 300 V, 60 C, 2.5mm², 3 Conductor cord, 3 m or less with a plug configured for the country of use to C14.

The power cord can be used to disconnect the RMX programmable power supply from the AC power line in an emergency. Connect the plug to an easily accessible power outlet so that the plug can be removed from the outlet at any time. Be sure to provide adequate clearance around the power outlet.

1. Check that the AC power line meets the nominal input rating of the product. The product can receive a nominal line voltage in the range of 100 VAC to 240 VAC at 50 Hz or 60 Hz.
2. Check that the POWER switch is turned off.
3. Connect the power cord to the AC inlet on the rear panel.
4. Insert the power plug into a grounded outlet.

RMX-4124/4125/4126/4127 (1500 W Models)



Caution Risk of electric shock. Before you connect the power cord, turn off the switchboard breaker (a switch that cuts off the power supply from the switchboard).

Risk of fire. Connection to the switchboard must be performed by a person who has knowledge about electrical safety standards and the electrical aspects of regulated DC power supplies. The switchboard breaker must meet the requirements shown below.



Caution Inside the product, protective circuits are connected to match the polarity of the input terminal. Be sure to connect the L, N, and (GND) terminals of the product to the matching terminals on the switchboard.

In an emergency, turn off the switchboard breaker to disconnect the product from the AC power line.

Necessary Cable

- Vinyl cabtire cable (VCTF): Nominal cross-sectional area 5.5 mm², 3 core
- Finished diameter: 10.5 to 14.4 mm in diameter
- Rated voltage: 250 V or higher
- Input terminal end: 14 mm of insulation stripped from conductor for the L and N wires.
Crimping terminal (round, M4) that fixes the cable insulation in place for the GND wire.
- Length: 3 m or less

Switchboard Breaker Requirements

- Installation must be done in accordance with national wiring rules, such as NFPA 70 "NEC" and CSA C22.1 "CEC".
- Rated current: 30 A (for safety, breakers whose rated current exceeds 30 A cannot be used)
- Do not power any other equipment from the switchboard breaker.
- Keep the breaker readily accessible at all times.
- Indicate that the breaker is dedicated for use with this product and that it is used to disconnect the product from the AC power line.

Figure 1. Switchboard Diagram

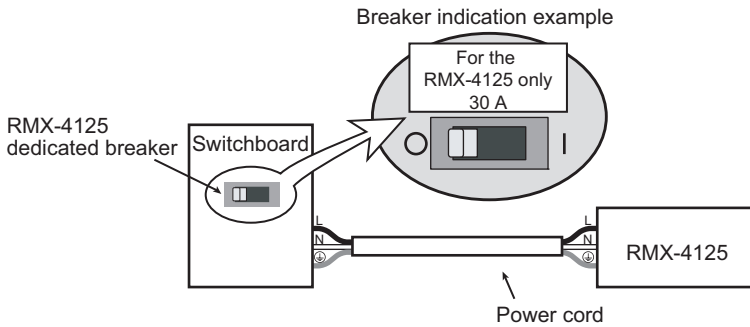

Connection Procedure

1. Check that the AC power line meets the nominal input rating of the product. The product can receive a nominal line voltage in the range of 100 VAC to 240 VAC at 50 Hz or 60 Hz.
2. Check that the POWER switch is turned off.
3. Attach a crimping terminal to the GND wire.

Figure 2. Attaching the Crimping Terminal

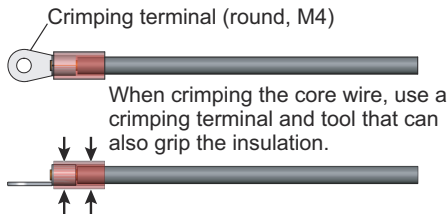

4. Connect the power cord and the included INPUT terminal cover to the AC INPUT terminal on the rear panel. Be sure to connect the AC INPUT L, N, and (GND) terminals correctly. Pass the power cord through the INPUT terminal cover, and fix the cord in place using the cable gland.

Figure 3. Connecting the Power Cord

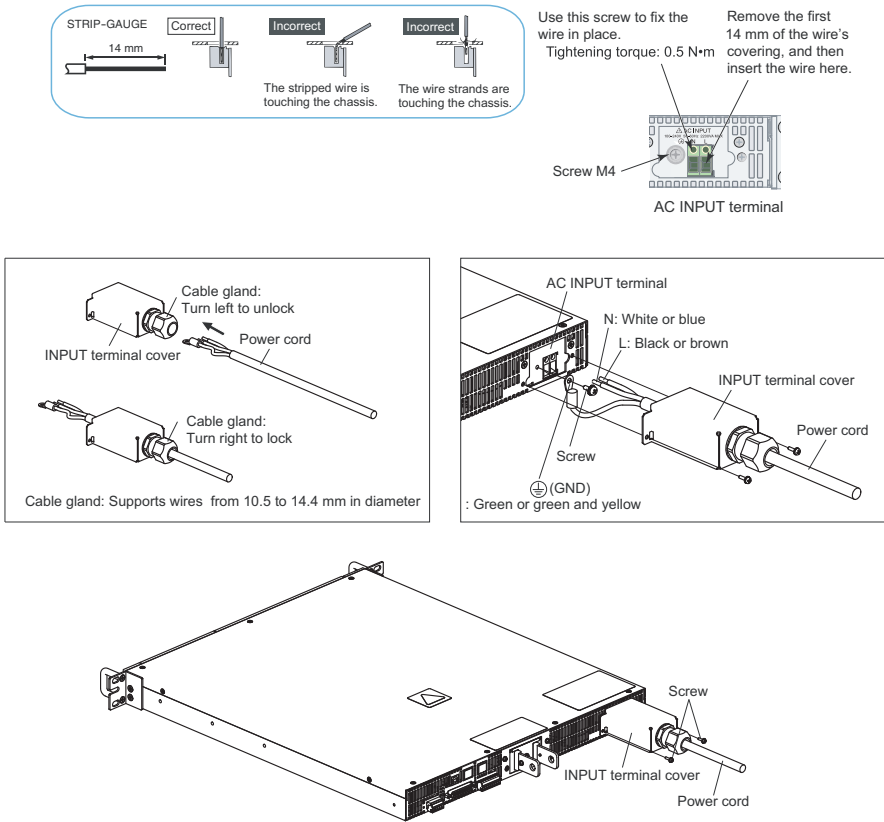

5. Attach an appropriate crimping terminal to the switchboard end of the power cord.
6. Turn off the switchboard breaker.
7. Connect the L, N, and (GND) wires of the power cord to the matching terminals on the switchboard.

Turning the Power On

Turning the POWER Switch On



Caution Risk of electric shock. Regardless of whether load cables are connected to the output terminals, be sure to attach the OUTPUT terminal cover before turning the POWER switch on.

Load Cables



Caution Risk of fire. Use load cables whose capacity is adequate for the RMX programmable power supply's rated output current. The output connector and its surrounding area become hot. Use cables whose covers have heat resistance at 85 °C and higher.



Caution Risk of electric shock. Use the cable which has higher withstanding voltage than the specified insulation voltage of the product to secure the double insulation or reinforced insulation.

Connecting to the Output Terminals



Caution Risk of electric shock. Turn the POWER switch off before you touch the OUTPUT terminals. Even if you turn the output off or turn the POWER switch off, if the bleeder on/off setting (CF11) is set to "OFF," the voltage that was present when the output was on will remain at the output terminals. Turn the bleeder circuit on before you touch the output terminals. Regardless of whether load cables are connected to the output terminals, be sure to attach the OUTPUT terminal cover before turning the POWER switch on. Confirm that the voltage between any output terminal and ground is lower than the isolation voltage of the RMX programmable power supply.

Figure 4. RMX-4125 Output Terminal

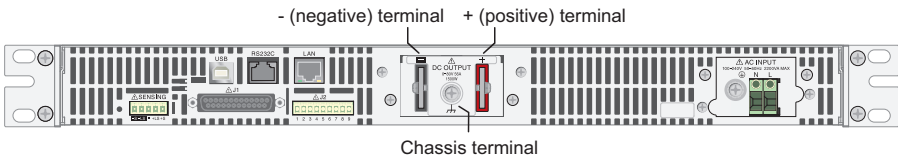

1. Turn the POWER switch off. Check that there is no voltage across the output terminals.
2. Connect one end of the included chassis connection wire to the chassis terminal, and then connect the other end of the wire to the negative or positive output terminal.



Note For safety reasons, connect one of the output terminals to the chassis terminal unless your application requires the output terminals to be floating

Use the screw on the RMX to connect the wire to the chassis terminal. Use the screw on the output terminal to connect the wire to the output terminal.

Figure 5. RMX-4120/4121/4124/4125

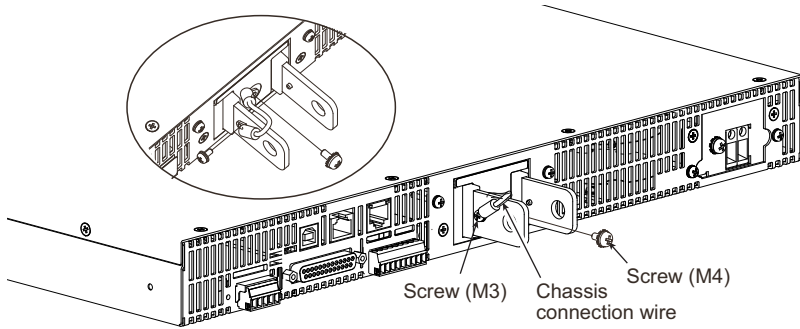
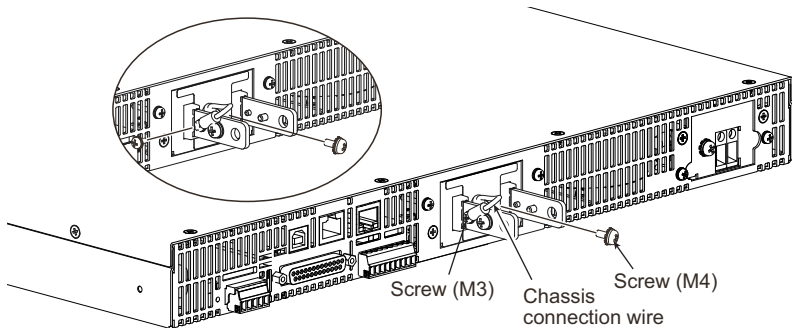

Figure 6. RMX-4122/4123/4126/4127



3. Attach crimping terminals to the load cables.
The output terminals have holes for connecting the load cables. Use crimping terminals that are appropriate for the bolts that you are using.
4. Use the included bolt set to connect the load cables to the output terminals.
Connect the positive cable to the positive output terminal and the negative cable to the negative output terminal. The orientation of the crimping terminals will vary depending on the wire diameter of the load cables used.

Figure 7. Connection Using M8 Bolt Set for RMX-4120/4121/4124/4125

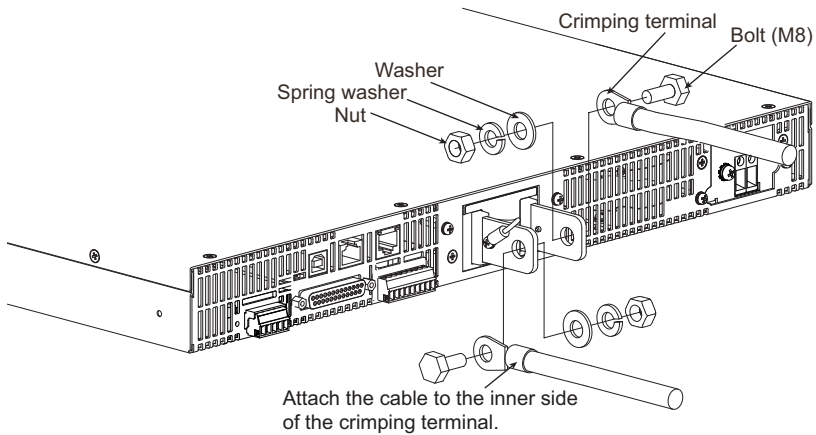
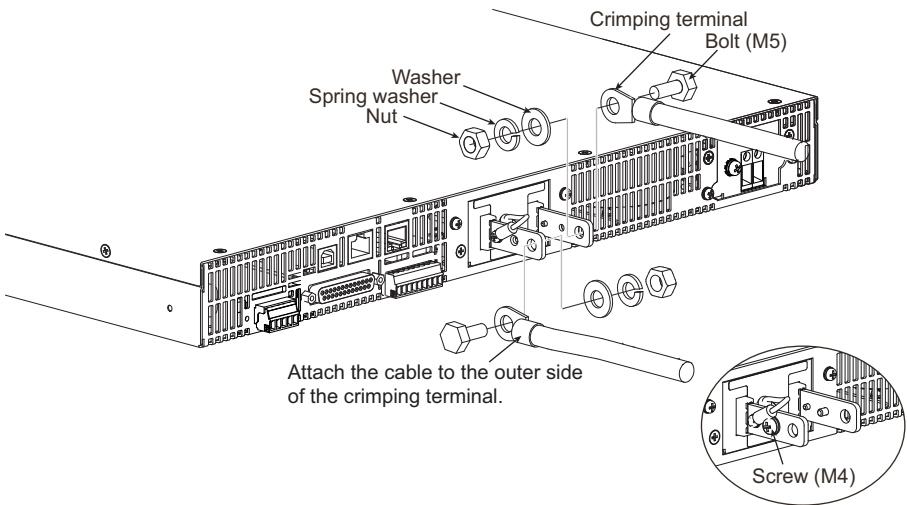

Figure 8. Connection Using M5 Bolt Set for RMX-4122/4123/4126/4127



Note If you do not connect load cables in the correct orientation, you will not be able to attach the OUTPUT terminal cover.

Attaching the Output Terminal Cover

You can adjust the diameter of the holes that the load cables pass through by changing the positions in which the top and bottom halves of the OUTPUT terminal cover are put together.

There are two available positions. Use the appropriate position for the load cables that you are using.

- For cables that are up to 10 mm in diameter: Put the top and bottom halves of the OUTPUT terminal cover together so that the hole diameter is small.
 - For cables that are between 10 mm and 18 mm in diameter: Put the top and bottom halves of the OUTPUT terminal cover together so that the hole diameter is large.
1. Remove the screw that is attached next to the output terminals on the RMX. Use this screw to attach the OUTPUT terminal cover.
 2. Place the bottom half of the OUTPUT terminal cover underneath the load cables connected to the output terminals.

Figure 9. Attaching Bottom Half of the OUTPUT Terminal Cover

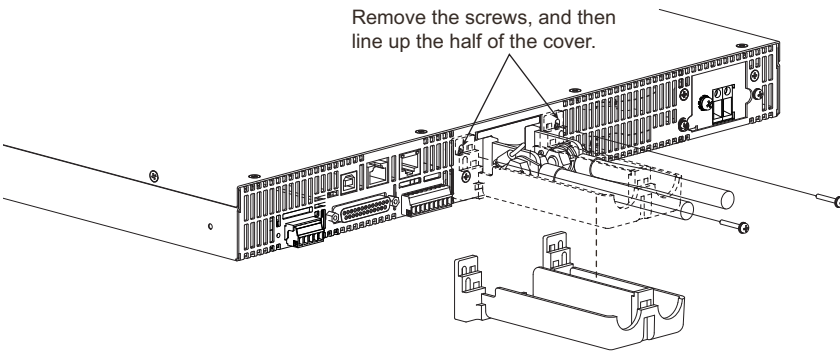

Note The top and bottom halves of the OUTPUT terminal cover have different shapes.

3. Align the tabs of the top half of the OUTPUT terminal cover with those of the bottom half. Align the tabs of the OUTPUT terminal cover according to the load cable diameter.

Figure 10. Aligning Both Halves of the OUTPUT Terminal Cover

For thin load cables

Cover hole diameter:
Up to 10 mm

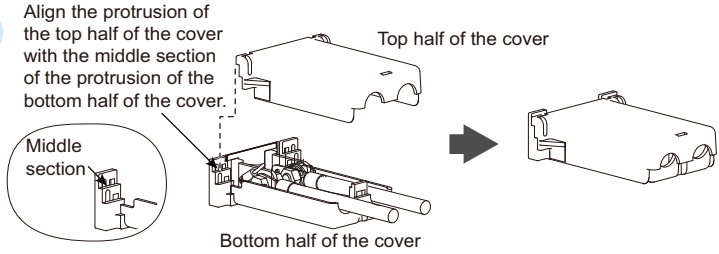

For thick load cables

Cover hole diameter:
10 mm to 18 mm

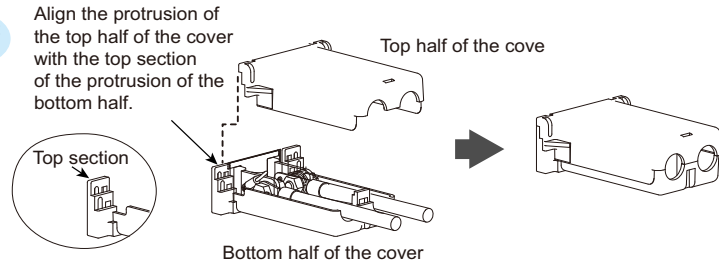

4. Push the OUTPUT terminal cover against the rear panel, and then use the RMX screws to fix the cover in place. Ensure that the screws are securely fastened.

Figure 11. Attaching the OUTPUT Terminal Cover

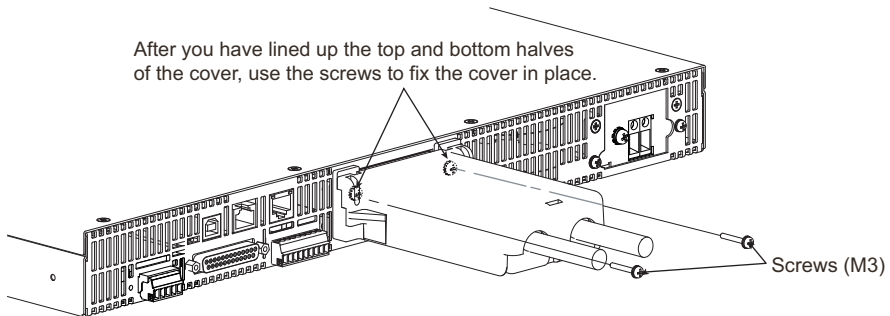

Specifications

RMX-4120/4121/4122/4123

AC Input

Nominal input rating..... 100 to 240 VAC, 50 to 60 Hz, single phase

Input voltage range 85 to 265 VAC

Input frequency..... 47 to 63 Hz

Current (MAX)¹

100 VAC..... 10.5 A

200 VAC..... 5.25 A

Environmental conditions

Operating environment..... Indoor use, overvoltage category II

Operating temperature 0 to 50 °C (32 to 122 °F)

Operating humidity..... 20 to 85% rh (no condensation)

Altitude Up to 2,000 m

Pollution degree..... 2

RMX-4124/4125/4126/4127

AC Input

Nominal input rating..... 100 to 240 VAC, 50 to 60 Hz, single phase

Input voltage range 85 to 265 VAC

Input frequency..... 47 to 63 Hz

Current (MAX)¹

100 VAC..... 21 A

200 VAC..... 10.5 A

Environmental conditions

Operating environment..... Indoor use, overvoltage category II

Operating temperature 0 to 50 °C (32 to 122 °F)

Operating humidity..... 20 to 85% rh (no condensation)

Altitude Up to 2,000 m

Pollution degree..... 2

¹ With the rated load.

Safety

This product is designed to meet the requirements of the following standards of safety for electrical equipment for measurement, control, and laboratory use:

- IEC/EN 61010-1
- UL 61010-1
- CSA C22.2 No. 61010-1



Note For safety certifications, refer to the product label or the [Online Product Certification](#) section.

Electromagnetic Compatibility

This product meets the requirements of the following EMC standards for electrical equipment for measurement, control, and laboratory use:

- EN 61326-1 (IEC 61326-1): Class A emissions; Basic immunity
- EN 55011 (CISPR 11): Group 1, Class A emissions

AS/NZS CISPR 11: Group 1, Class A emissions

- FCC 47 CFR Part 15B: Class A emissions
- ICES-001: Class A emissions



Note In the United States (per FCC 47 CFR), Class A equipment is intended for use in commercial, light industrial, and heavy industrial locations. In Europe, Canada, Australia, and New Zealand (per CISPR 11), Class A equipment is intended for use only in heavy industrial locations.



Note Group 1 equipment (per CISPR 11) is any industrial, scientific, or medical equipment that does not intentionally generate radio frequency energy for the treatment of material or inspection/analysis purposes.



Note For EMC declarations and certifications and additional information, refer to the [Online Product Certification](#) section.

CE Compliance

This product meets the essential requirements of applicable European Directives as follows:

- 2014/35/EU; Low-Voltage Directive (safety)
- 2014/30/EU; Electromagnetic Compatibility Directive (EMC)
- 2011/65/EU; RoHS

Online Product Certification

Refer to the product Declaration of Conformity (DoC) for additional regulatory compliance information. To obtain product certifications and the DoC for this product, visit ni.com/certification, search by model number or product line, and click the appropriate link in the Certification column.

Environmental Management

NI is committed to designing and manufacturing products in an environmentally responsible manner. NI recognizes that eliminating certain hazardous substances from our products is beneficial to the environment and to NI customers.

For additional environmental information, refer to the *Minimize Our Environmental Impact* web page at ni.com/environment. This page contains the environmental regulations and directives with which NI complies, as well as other environmental information not included in this document.

Waste Electrical and Electronic Equipment (WEEE)



EU Customers At the end of the product life cycle, all products *must* be sent to a WEEE recycling center. For more information about WEEE recycling centers, National Instruments WEEE initiatives, and compliance with WEEE Directive 2002/96/EC on Waste and Electronic Equipment, visit ni.com/environment/weee.

电子信息产品污染控制管理办法（中国 RoHS）



中国客户 National Instruments 符合中国电子信息产品中限制使用某些有害物质指令 (RoHS)。关于 National Instruments 中国 RoHS 合规性信息，请登录 ni.com/environment/rohs_china。(For information about China RoHS compliance, go to ni.com/environment/rohs_china.)

Worldwide Support and Services

The NI website is your complete resource for technical support. At ni.com/support you have access to everything from troubleshooting and application development self-help resources to email and phone assistance from NI Application Engineers.

Visit ni.com/services for NI Factory Installation Services, repairs, extended warranty, and other services.

Visit ni.com/register to register your NI product. Product registration facilitates technical support and ensures that you receive important information updates from NI.

A Declaration of Conformity (DoC) is our claim of compliance with the Council of the European Communities using the manufacturer's declaration of conformity. This system affords the user protection for electromagnetic compatibility (EMC) and product safety. You can obtain the DoC for your product by visiting ni.com/certification. If your product supports calibration, you can obtain the calibration certificate for your product at ni.com/calibration.

NI corporate headquarters is located at 11500 North Mopac Expressway, Austin, Texas, 78759-3504. NI also has offices located around the world. For telephone support in the United States, create your service request at ni.com/support or dial 1 866 ASK MYNI (275 6964). For telephone support outside the United States, visit the Worldwide Offices section of ni.com/niglobal to access the branch office websites, which provide up-to-date contact information, support phone numbers, email addresses, and current events.

Refer to the *NI Trademarks and Logo Guidelines* at ni.com/trademarks for more information on NI trademarks. Other product and company names mentioned herein are trademarks or trade names of their respective companies. For patents covering NI products/technology, refer to the appropriate location: **Help»Patents** in your software, the `patents.txt` file on your media, or the *National Instruments Patents Notice* at ni.com/patents. You can find information about end-user license agreements (EULAs) and third-party legal notices in the `readme` file for your NI product. Refer to the *Export Compliance Information* at ni.com/legal/export-compliance for the NI global trade compliance policy and how to obtain relevant HTS codes, ECCNs, and other import/export data. NI MAKES NO EXPRESS OR IMPLIED WARRANTIES AS TO THE ACCURACY OF THE INFORMATION CONTAINED HEREIN AND SHALL NOT BE LIABLE FOR ANY ERRORS. U.S. Government Customers: The data contained in this manual was developed at private expense and is subject to the applicable limited rights and restricted data rights as set forth in FAR 52.227-14, DFAR 252.227-7014, and DFAR 252.227-7015.

© 2016-2017 National Instruments. All rights reserved.